

## ZyWALL/USG/ATP /VPN Series

ATP200/ ATP500/ ATP800

USG20-VPN / USG20W-VPN / USG40 / USG40W /  
USG60 / USG60W / USG110 / USG210 / USG310/  
USG1100 /USG1900 / USG2200-VPN

VPN50 / VPN100 /VPN300 /VPN1000

### Security Firewalls

Firmware Version 4.35  
Edition 3, 10/2019

## Handbook

### Default Login Details

LAN Port IP Address	https://192.168.1.1
User Name	admin
Password	1234

## Table of Content

<b>How to Configure Site-to-site IPSec VPN with Amazon VPC.....</b>	<b>18</b>
Set Up the IPSec VPN Tunnel on the Amazon VPC.....	19
Set Up the IPSec VPN Tunnel on the ZyWALL/USG.....	23
Test the IPSec VPN Tunnel.....	29
What Could Go Wrong?.....	30
<b>How to Configure Site-to-site IPSec VPN with Microsoft (MS) Azure .....</b>	<b>31</b>
Set Up the IPSec VPN Tunnel on the ZyWALL/USG.....	32
Set Up the IPSec VPN Tunnel on the MS Azure.....	37
Test the IPSec VPN Tunnel.....	44
What Could Go Wrong? .....	47
<b>How to Configure GRE over IPSec VPN Tunnel.....</b>	<b>48</b>
Set Up the ZyWALL/USG GRE over IPSec VPN Tunnel of Corporate Network (HQ).....	49
Set Up the ZyWALL/USG GRE over IPSec VPN Tunnel of Corporate Network (Branch).....	54
Test the GRE over IPSec VPN Tunnel.....	58
What Could Go Wrong?.....	59
<b>How to Configure Site-to-site IPSec VPN Where the Peer has a Static IP Address .....</b>	<b>61</b>
Set Up the ZyWALL/USG IPSec VPN Tunnel of Corporate Network (Branch).....	66
Test the IPSec VPN Tunnel.....	70
What Could Go Wrong? .....	71
<b>How to Configure Site-to-site IPSec VPN Where the Peer has a Dynamic IP Address .....</b>	<b>73</b>
Set Up the ZyWALL/USG IPSec VPN Tunnel of Corporate Network (HQ) .....	73
Set Up the ZyWALL/USG IPSec VPN Tunnel of Corporate Network (Branch has a Dynamic IP Address) .....	77
Test the IPSec VPN Tunnel.....	81

What Could Go Wrong? .....	83
<b>How to Configure IPSec Site to Site VPN while one Site is behind a NAT router .....</b>	<b>85</b>
Set Up the ZyWALL/USG IPSec VPN Tunnel of Corporate Network (HQ) .....	85
Set Up the ZyWALL/USG IPSec VPN Tunnel of Corporate Network (Branch).....	89
Set Up the NAT Router (Using ZyWALL USG device in this example)	93
Test the IPSec VPN Tunnel .....	95
What Could Go Wrong? .....	96
<b>How to Configure Hub-and-Spoke IPSec VPN .....</b>	<b>97</b>
Set Up the IPSec VPN Tunnel on the ZyWALL/USG by Using VPN Concentrator Hub_HQ-to-Branch_A .....	98
Hub_HQ-to-Branch_B.....	102
Hub_HQ Concentrator .....	106
Spoke_Branch_A .....	107
Spoke_Branch_B.....	112
Test the IPSec VPN Tunnel .....	117
What Could Go Wrong? .....	121
Set Up the IPSec VPN Tunnel of ZyWALL/USG without Using VPN Concentrator Hub_HQ-to-Branch_A .....	123
Hub_HQ-to-Branch_B.....	126
Spoke_Branch_A .....	129
Spoke_Branch_B.....	132
Test the IPSec VPN Tunnel .....	135
What Could Go Wrong? .....	138
<b>How to Use Dual-WAN to Perform Fail-Over on VPN Using the VPN Concentrator .....</b>	<b>140</b>
Set Up the IPSec VPN Tunnel on the ZyWALL/USG Hub_HQ-to-Branch_A.....	141
Hub_HQ-to-Branch_B.....	144
Hub_HQ Concentrator .....	147
Spoke_Branch_A .....	148
Spoke_Branch_B.....	151

Test the IPsec VPN Tunnel.....	155
What Could Go Wrong? .....	158
<b>How to Configure IPsec VPN with ZyWALL IPsec VPN Client .....</b>	<b>159</b>
Set Up the ZyWALL/USG IPsec VPN Tunnel .....	160
Set Up the ZyWALL IPsec VPN Client .....	164
Test the IPsec VPN Tunnel .....	167
What Can Go Wrong?.....	169
<b>How to Configure Site-to-site IPsec VPN with FortiGate.....</b>	<b>171</b>
Set Up the IPsec VPN Tunnel on the ZyWALL/USG.....	172
Set Up the IPsec VPN Tunnel on the FortiGate.....	175
Test the IPsec VPN Tunnel .....	180
What Could Go Wrong? .....	181
<b>How to Configure Site-to-site IPsec VPN with WatchGuard .....</b>	<b>183</b>
Set Up the IPsec VPN Tunnel on the ZyWALL/USG.....	184
Set Up the IPsec VPN Tunnel on the WatchGuard.....	187
Test the IPsec VPN Tunnel .....	193
What Could Go Wrong? .....	194
<b>How to Configure Site-to-site IPsec VPN with Cisco.....</b>	<b>196</b>
Set Up the IPsec VPN Tunnel on the ZyWALL/USG.....	197
Set Up the IPsec VPN Tunnel on the Cisco .....	202
Test the IPsec VPN Tunnel .....	207
What Could Go Wrong? .....	209
<b>How to Configure Site-to-site IPsec VPN with a SonicWALL router .....</b>	<b>210</b>
Set Up the IPsec VPN Tunnel on the ZyWALL/USG.....	211
Set Up the IPsec VPN Tunnel on the SonicWALL .....	218
Test the IPsec VPN Tunnel .....	222
What Could Go Wrong? .....	224
<b>How to Configure IPsec VPN Failover .....</b>	<b>227</b>
Set Up the ZyWALL/USG IPsec VPN Tunnel of Corporate Network (HQ) .....	228
Set Up the ZyWALL/USG IPsec VPN Tunnel of Corporate Network (Branch).....	231
Set up the WAN Trunk (ZyWALL/USG_HQ) .....	236

Set up the Failover Command Line (ZyWALL/USG HQ) .....	237
Test the IPsec VPN Tunnel .....	238
What Could Go Wrong? .....	240
<b>How to Configure L2TP over IPsec VPN while the ZyWALL/USG is behind a NAT router .....</b>	<b>242</b>
Set Up the L2TP VPN Tunnel on the ZyWALL/USG_HQ .....	243
Set Up the NAT Router (Using ZyWALL USG device in this example) .....	247
Test the L2TP over IPsec VPN Tunnel .....	250
What Could Go Wrong? .....	253
<b>How to Configure L2TP VPN with Android 5.0 Mobile Devices .....</b>	<b>255</b>
Set Up the L2TP VPN Tunnel on the ZyWALL/USG .....	256
Set Up the L2TP VPN Tunnel on the Android Device .....	260
Test the L2TP over IPsec VPN Tunnel .....	263
What Could Go Wrong? .....	265
<b>How to Configure L2TP VPN with iOS 8.4 Mobile Devices.....</b>	<b>267</b>
Set Up the L2TP VPN Tunnel on the ZyWALL/USG .....	267
Set Up the L2TP VPN Tunnel on the iOS Device .....	273
Test the L2TP over IPsec VPN Tunnel .....	274
What Could Go Wrong? .....	277
<b>How to Import ZyWALL/USG Certificate for L2TP over IPsec in Windows 10 .....</b>	<b>279</b>
Set Up the L2TP VPN Tunnel on the ZyWALL/USG .....	279
Export a Certificate from ZyWALL/USG and Import it to Windows 10 Operating System .....	284
Set Up the L2TP VPN Tunnel on the Windows 10.....	290
Test the L2TP over IPsec VPN Tunnel .....	294
What Could Go Wrong? .....	296
<b>How to Import ZyWALL/USG Certificate for L2TP over IPsec in IOS mobile phone.....</b>	<b>298</b>
Set Up the L2TP VPN Tunnel on the ZyWALL/USG .....	298
Export a Certificate from ZyWALL/USG and Import it to iOS Mobile Phone .....	303

Set Up the L2TP VPN Tunnel on the iOS Mobile Device .....	303
Test the L2TP over IPsec VPN Tunnel .....	306
What Could Go Wrong? .....	308
<b>How to Configure 2 factor for VPN connection?.....</b>	<b>309</b>
Set up the ZyWALL/USG IPsec VPN Tunnel.....	310
Set up the ZyWALL IPsec VPN Client .....	315
Set up notification for 2 factor authentication.....	319
Set up authentication for 2 factor VPN connection.....	320
Test the Result .....	321
What could went wrong .....	324
<b>How to Import ZyWALL/USG Certificate for L2TP over IPsec in Android mobile phone.....</b>	<b>324</b>
Set Up the L2TP VPN Tunnel on the ZyWALL/USG .....	325
Export a Certificate from ZyWALL/USG and Import it to Android Mobile Phone .....	329
Set Up the L2TP VPN Tunnel on the Android Mobile Device .....	330
Test the L2TP over IPsec VPN Tunnel .....	334
What Could Go Wrong? .....	336
<b>How to Configure the L2TP VPN with Apple MAC OS X 10.11 Operating System.....</b>	<b>338</b>
Set Up the L2TP VPN Tunnel on the ZyWALL/USG .....	338
Set Up the L2TP VPN Tunnel on the Apple MAC OS X 10.11 El Capitan Operating System .....	343
Test the L2TP over IPsec VPN Tunnel .....	346
What Could Go Wrong? .....	348
<b>How to configure if I want user can only see SSL VPN Login button in web portal login page.....</b>	<b>350</b>
Set Up the DNS Service.....	351
Set Up the ZyWALL/USG SSL VPN Setting.....	351
Set Up the ZyWALL/USG System Setting .....	352
Test the SSL VPN .....	353
<b>How to Deploy SSL VPN with Apple Mac OS X 10.10 Operating System .....</b>	<b>357</b>

Set Up the SSL VPN Tunnel on the ZyWALL/USG .....	358
Set Up the SSL VPN Tunnel on the Apple MAC OS X 10.10 Operating System.....	361
Test the SSL VPN Tunnel.....	365
What Could Go Wrong? .....	368
<b>How To Configure SSL VPN for Remote Access Mobile Devices .....</b>	<b>370</b>
Set Up the SSL VPN Tunnel on the ZyWALL/USG .....	371
Test the SSL VPN Tunnel.....	374
What Could Go Wrong? .....	376
<b>How to Configure an SSL VPN Tunnel (with SecuExtender version 4.0.0.1) on the Windows 10 Operating System .....</b>	<b>377</b>
Set up the SSL VPN Tunnel with Windows 10 .....	377
What Can Go Wrong? .....	381
<b>How to redirect multiple LAN interface traffic to the VPN tunnel .....</b>	<b>383</b>
Set Up the ZyWALL/USG IPsec VPN Tunnel of Corporate Network (HQ) .....	384
Set Up the ZyWALL/USG IPsec VPN Tunnel of Corporate Network (Branch).....	387
Set up the Policy Route (ZyWALL/USG_HQ) .....	391
Set up the Policy Route (ZyWALL/USG_Branch) .....	392
Test the IPsec VPN Tunnel .....	394
What Could Go Wrong? .....	395
<b>How to Create VTI and Configure VPN Failover with VTI.....</b>	<b>397</b>
VTI Deployment Flow .....	397
Set Up the ZyWALL/USG VTI of Corporate Network (HQ) .....	398
Set Up the ZyWALL/USG VTI of Corporate Network (Branch) .....	403
Test the IPsec VPN Tunnel .....	409
What Can Go Wrong? .....	411
<b>How to configure the USG when using a Cloud Based SIP system .....</b>	<b>413</b>
Set Up the SIP ALG.....	414
Test result .....	414
What could go wrong? .....	415

<b>How to block HTTPS websites by Domain Filter without applying SSL Inspection .....</b>	<b>415</b>
Set Up the Content Filter on the ZyWALL/USG .....	416
Set Up the Security Policy on the ZyWALL/USG .....	419
Set Up the System Policy on the ZyWALL/USG .....	419
Test the Result .....	419
<b>How to Configure Content Filter 2.0 with Geo IP Blocking .....</b>	<b>422</b>
Set Up the Address Object with Geo IP on the ZyWALL/USG.....	423
Set Up the Security Policy on the ZyWALL/USG .....	423
Test the Result .....	424
What Could Go Wrong? .....	425
<b>How to Configure Content Filter 2.0 with HTTPs Domain Filter .....</b>	<b>426</b>
Application Scenario .....	426
Set Up the Content Filter on the ZyWALL/USG .....	427
Set Up the Security Policy on the ZyWALL/USG .....	429
Set Up the System Policy on the ZyWALL/USG .....	430
Test the Result .....	431
What Could Go Wrong? .....	431
<b>How to block the client accessing to certain country using Geo IP and Content Filter .....</b>	<b>432</b>
Check Geo IP License Status on the ZyWALL/USG.....	433
Set Up the Address Object with Geo IP on the ZyWALL/USG.....	434
Set Up the Security Policy on the ZyWALL/USG .....	435
Test the Result .....	436
<b>How to Restrict Web Portal access from the Internet .....</b>	<b>439</b>
Set Up the ZyWALL/USG System Setting .....	439
Test the Web Access .....	440
<b>How to Setup and Configure Daily Report.....</b>	<b>443</b>
Set Up the ZyWALL/USG Email Daily Report Setting.....	444
Test the Daily Log Report .....	445
What Could Go Wrong? .....	447
<b>How to Setup and Configure Email Logs .....</b>	<b>448</b>



Set Up the ZyWALL/USG Email Logs Setting.....	449
Test the Email Log .....	450
What Could Go Wrong? .....	451
<b>How to Setup and send logs to a Syslog Server.....</b>	<b>452</b>
Set Up the Syslog Server (Use Papertrail syslog in this example) .....	452
Set Up the ZyWALL/USG Remote Server Setting .....	455
Test the Remote Server .....	456
What Could Go Wrong? .....	457
<b>How to Setup and send logs to a Vantage Reports Server.....</b>	<b>458</b>
Set Up the VRPT Server .....	459
Set Up the ZyWALL/USG Remote Server Setting .....	462
Test the Remote Server .....	463
What Could Go Wrong? .....	463
<b>How to Setup and send logs to the USB storage .....</b>	<b>464</b>
Set Up the USB System Settings .....	465
Set Up the USB Log Storage .....	466
Check the USG Log Files .....	467
<b>How to Activate a Free Access Hotspot.....</b>	<b>467</b>
Set up the Free Access Hotspot .....	469
Test the User Agreement and Advertisement Webpage .....	470
What could Go Wrong? .....	472
Set up Enable the Free Time Feature.....	472
Test Free Time Feature .....	478
What Can Go Wrong? .....	481
<b>How to Setup IPv6 Interfaces for Pure IPv6 Routing .....</b>	<b>483</b>
Setting Up the IPv6 Interface .....	484
Set up the Prefix Delegation and Router Advertisement .....	486
Test .....	490
What Can Go Wrong? .....	491
Test .....	493
<b>How to Perform and Use the Packet Capture Feature on the ZyWALL/USG .....</b>	<b>493</b>
Set Up the Packet Capture Feature.....	494

Check the Capture Files.....	497
<b>How to Automatically Reboot the ZyWALL/USG by Schedule.....</b>	<b>498</b>
Set Up the Shell Script .....	499
Set Up the Schedule Run.....	500
Check the Reboot Status .....	502
<b>How To Schedule YouTube Access.....</b>	<b>504</b>
Set Up the Schedule on the ZyWALL/USG.....	504
Create the Application Objects on the ZyWALL/USG .....	505
Set Up SSL Inspection on the ZyWALL/USG .....	505
Set Up the Security Policy on the ZyWALL/USG .....	506
Export Certificate from ZyWALL/USG and Import it to Windows 7 Operation System .....	507
Test the Result .....	513
What Could Go Wrong? .....	513
<b>How to continuously run a ZySH script.....</b>	<b>515</b>
Set Up the Shell Script .....	515
Set Up the Schedule Run.....	517
Check the Result .....	517
<b>How To Register Your Device and Services at myZyXEL.com .....</b>	<b>518</b>
Account Creation.....	519
Device Registration.....	521
Service Registration (In the Case of Standard License) .....	522
Device Management (In the Case of Registering Bundled Licenses) .....	523
Refresh Service .....	524
What Could Go Wrong? .....	524
<b>How To Exempt Specific Users From Security Control .....</b>	<b>526</b>
Set Up the Security Policy on the ZyWALL/USG for Employees .....	527
Set Up the Security Policy on the ZyWALL/USG for Executives.....	529
Test the Result .....	531
What Could Go Wrong? .....	532
<b>How To Detect and Prevent TCP Port Scanning with ADP .....</b>	<b>533</b>
Set Up the ADP Profile on the ZyWALL/USG .....	534

Test the Result .....	537
What Could Go Wrong? .....	538
<b>How To Block Facebook .....</b>	<b>539</b>
Set Up the Content Filter on the ZyWALL/USG .....	540
Set Up the SSL Inspection on the ZyWALL/USG .....	540
Set Up the Security Policy on the ZyWALL/USG .....	542
Export Certificate from ZyWALL/USG and Import it to Windows 7 Operation System .....	543
Test the Result .....	548
What Could Go Wrong? .....	549
<b>How To Exempt Specific Users From a Blocked Website .....</b>	<b>550</b>
Set Up the Security Policy on the ZyWALL/USG for Employees .....	551
Set Up the Security Policy on the ZyWALL/USG for Executives .....	553
Test the Result .....	556
What Could Go Wrong? .....	557
<b>How To Control Access To Google Drive .....</b>	<b>558</b>
Set Up the SSL Inspection on the ZyWALL/USG .....	559
Set Up the Security Policy on the ZyWALL/USG .....	560
Export Certificate from ZyWALL/USG and Import it to Windows 7 Operation System .....	560
Test the Result .....	566
What Could Go Wrong? .....	567
<b>How To Block HTTPS Websites Using Content Filtering and SSL Inspection .....</b>	<b>568</b>
Set Up the Content Filter on the ZyWALL/USG .....	569
Set Up SSL Inspection on the ZyWALL/USG .....	570
Set Up the Security Policy on the ZyWALL/USG .....	572
Export Certificate from ZyWALL/USG and Import it to Windows 7 Operation System .....	573
Test the Result .....	578
What Could Go Wrong? .....	579
<b>How To Block the Spotify Music Streaming Service .....</b>	<b>580</b>
Set Up IDP Profile on the ZyWALL/USG .....	581

Test the Result .....	582
What Could Go Wrong? .....	583
<b>How does Anti-Malware work .....</b>	<b>584</b>
Enable Anti-Malware function to protecting your traffic .....	585
Test the result .....	586
Additional configuration .....	586
What can go wrong .....	587
<b>How to Configure an Email Security Policy with Mail Scan and DNSBL</b>	<b>588</b>
Set Up the Email Security on ATP Series .....	588
Test the result .....	591
What can go wrong .....	592
<b>How to Configure Botnet Filter on ATP series? .....</b>	<b>593</b>
Prerequisites before setting up Botnet Filter function .....	594
License activation.....	594
Update Botnet Filter Signatures .....	594
Set Up the IP Blocking on the ATP series .....	596
Test the Result .....	596
Set up the URL Blocking on the ATP series .....	597
Test the Result .....	597
<b>How to Use Sandboxing to Detect Unknown Malware .....</b>	<b>599</b>
Set Up Sandboxing on ATP .....	600
Test the Result .....	602
What Can Go Wrong?.....	605
<b>How to Configure Bandwidth Management for FTP and HTTP Traffic ..</b>	<b>606</b>
Set Up the Bandwidth Management for FTP on the ZyWALL/USG	607
Set Up the Bandwidth Management for HTTP on the ZyWALL/USG	608
.....	608
Set Up the Bandwidth Management Global Setting on the	
ZyWALL/USG.....	610
Test the Result .....	611
What Could Go Wrong? .....	612
<b>How to Limit BitTorrent or Other Peer-to-Peer Traffic .....</b>	<b>613</b>
Set Up the Application Patrol Profile on the ZyWALL/USG .....	614

Set Up the Bandwidth Management for BitTorrent on the ZyWALL/USG.....	615
Set Up the Bandwidth Management Global Setting on the ZyWALL/USG.....	617
Test the Result .....	617
What Could Go Wrong? .....	618
<b>How to Configure a Trunk for WAN Load Balancing with a Static or Dynamic IP Address.....</b>	<b>619</b>
Set Up the Available Bandwidth on WAN1 Interfaces on the ZyWALL/USG.....	620
Set Up the Available Bandwidth on WAN2 Interfaces on the ZyWALL/USG.....	621
Set Up the WAN Trunk on the ZyWALL/USG .....	621
Test the Result .....	622
What Could Go Wrong? .....	623
<b>How to Configure DNS Inbound Load Balancing to balance DNS Queries Among Interfaces .....</b>	<b>624</b>
Set Up the DNS Inbound Load Balancing on the ZyWALL/USG .....	625
Set Up the NAT Rule on the ZyWALL/USG .....	626
Test the Result .....	627
What Could Go Wrong? .....	628
<b>How to Manage Voice Traffic .....</b>	<b>629</b>
Set Up the SIP ALG on the ZyWALL/USG .....	630
Set Up the Bandwidth Management for SIP on the ZyWALL/USG .....	630
Set Up the Bandwidth Management for P2P on the ZyWALL/USG .....	631
Set Up the Bandwidth Management for FTP on the ZyWALL/USG .....	632
Test the Result .....	634
What Could Go Wrong? .....	635
<b>How to Manage ZyWALL/USG Configuration Files .....</b>	<b>636</b>
Rename the Configuration Files from the ZyWALL/USG .....	637
Download the Configuration Files on the ZyWALL/USG .....	637
Copy the Configuration Files on the ZyWALL/USG .....	638
Apply the Configuration Files on the ZyWALL/USG .....	639

Upload the Configuration Files from the ZyWALL/USG .....	640
What Could Go Wrong? .....	640
<b>How to Manage ZyWALL/USG Firmware .....</b>	<b>641</b>
Download the Current Firmware Version from ZyXEL.com .....	642
Upload the Firmware on the ZyWALL/USG .....	643
What Could Go Wrong? .....	646
<b>How to Get Started Using the Wizards.....</b>	<b>647</b>
Set Up the Internet Access (Ethernet) Wizard on the ZyWALL/USG .....	647
Set Up the Internet Access (PPPoE) Wizard on the ZyWALL/USG ..	651
Set Up the Internet Access (PPTP) Wizard on the ZyWALL/USG .....	654
Set Up the Wireless Settings Wizard on the ZyWALL/USG.....	658
Set Up the Device Registration on the ZyWALL/USG .....	660
<b>How to Configure the 3G/LTE Interface on the ZyWALL/USG as a WAN Backup.....</b>	<b>662</b>
Set Up the 3G/LTE Interface on the ZyWALL/USG .....	663
Set Up the Trunk on the ZyWALL/USG .....	664
Test the Result .....	665
What Could Go Wrong? .....	666
<b>How to Configure Two Different WAN Interfaces with Different IP Addresses in the Same VLAN.....</b>	<b>667</b>
Set Up the Port Grouping on the ZyWALL/USG .....	668
Set Up the VLAN on the ZyWALL/USG.....	668
Set Up the Routing on the ZyWALL/USG .....	670
Test the Result .....	670
What Could Go Wrong? .....	671
<b>How to Let a Server Use the Same Public IP Address as the WAN Interface Using the Bridge Interface .....</b>	<b>671</b>
Set Up the Bridge Interface on the ZyWALL/USG .....	672
Test the Result .....	674
What Could Go Wrong? .....	675
<b>How to Allow Public Access to a Server Behind ZyWALL/USG .....</b>	<b>675</b>
Set Up the NAT on the ZyWALL/USG .....	676

Set Up the Security Policy on the ZyWALL/USG .....	677
Test the Result .....	678
What Could Go Wrong? .....	678
<b>How to Set Up a WiFi Network with ZyXEL APs .....</b>	<b>680</b>
Set Up the AP Management on the ZyWALL/USG .....	681
Test the Result .....	683
What Could Go Wrong? .....	684
<b>How to Set Up Guest WiFi Network Accounts.....</b>	<b>685</b>
Set Up the WiFi Guest Account, Address Range and Service Rule on the ZyWALL/USG.....	686
Set Up the Web Authentication on the ZyWALL/USG.....	688
Set Up the Security Policy on the ZyWALL/USG .....	689
Test the Result .....	690
What Could Go Wrong? .....	693
<b>How to create a Wi-Fi VLAN interfaces to separate staff network and Guest network .....</b>	<b>695</b>
Set up Wi-Fi VLAN interfaces.....	696
Test result .....	706
What could go wrong .....	708
<b>How to Set Up WiFi Networks with Microsoft Active Directory Authentication.....</b>	<b>710</b>
Set Up the Wi-Fi Guest Account and Authentication Method on the ZyWALL/USG.....	711
Set Up the Active Directory Server Account on the ZyWALL/USG	712
Set Up the Security Policy on the ZyWALL/USG .....	713
Test the Result .....	714
What Could Go Wrong? .....	716
<b>How to Set Up IPv6 Interfaces for Pure IPv6 Routing .....</b>	<b>717</b>
Enable the IPv6 on the ZyWALL/USG .....	718
Set Up the WAN IPv6 Interface on the ZyWALL/USG.....	719
Set Up the LAN IPv6 Interface on the ZyWALL/USG .....	719
Test the Result .....	720
What Could Go Wrong? .....	722

<b>How to Set Up an IPv6 6to4 Tunnel .....</b>	<b>722</b>
Set Up the LAN IPv6 Interface on the ZyWALL/USG .....	723
Set Up the 6to4 Tunnel on the ZyWALL/USG .....	725
Test the Result .....	726
What Could Go Wrong? .....	727
<b>How to Set Up an IPv6-in-IPv4 Tunnel.....</b>	<b>727</b>
Set Up the LAN IPv6 Interface on the ZyWALL/USG .....	728
Set Up the 6to4 Tunnel on the ZyWALL/USG .....	729
Set Up the Policy Route on the ZyWALL/USG.....	730
Test the Result .....	731
What Could Go Wrong? .....	732
<b>How to Update Firmware Automatically from a USB Storage.....</b>	<b>733</b>
Automatic USB Firmware Upgrade Flow .....	733
Enable the USB Firmware Upgrade Function by CLI Command...	734
Save the Firmware on the USB.....	734
Plug the USB into the Device .....	735
The Device Checks Running Partition for the Model ID and the Firmware Version .....	735
Check Firmware Status.....	736
What Can Go Wrong?.....	737
<b>How to Configure DHCP Option 60 – Vendor Class Identifier .....</b>	<b>739</b>
DHCP Option 60 Deployment Flow.....	740
Setting Up DHCP Option 60 on the Web GUI.....	740
Setting Up DHCP Option 60 on the CLI.....	741
Test DHCP Option 60.....	742
What Can Go Wrong? .....	742
<b>How to Configure Device HA Pro .....</b>	<b>743</b>
Device HA Pro License .....	744
Behavior of the Device HA Pro .....	744
Device-HA Pro Setting Screen .....	744
Suggestions .....	746
How do I Configure Device HA Pro in My Current Environment? .	747
What can go wrong? .....	751



<b>How to setup Two-Factor Authentication for admin login .....</b>	<b>752</b>
Setup SMTP function on your device .....	752
Create admin type user on device .....	753
Setup Two-Factor Authentication for admin on your device .....	754
Test the Result .....	755
What Can Go Wrong? .....	757
<b>How to configure Email Security for Phishing mail? .....</b>	<b>759</b>
How it works .....	759
Set up Phishing on ATP .....	760
Test the Result .....	761
What Can Go Wrong? .....	761
<b>How to setup Email to SMS .....</b>	<b>763</b>
Setup SMTP function on your device .....	763
Setup Email to SMS Provider configuration .....	764
Create admin type user on device .....	765
Setup Two-Factor Authentication for admin on your device .....	765
Test the Result .....	766
What Can Go Wrong? .....	768
<b>How to Use IP Reputation to Detect Threats .....</b>	<b>769</b>
Activating Reputation Filter Service .....	770
Enabling IP Blocking on ATP .....	770
Selecting specific type of IP addresses to block .....	771
Adding IP addresses to white list and black list .....	771
Monitoring statistics for IP detection .....	772
Test the Result .....	772
What Can Go Wrong? .....	774

## How to Configure Site-to-site IPSec VPN with Amazon VPC

This example shows how to use the VPN Setup Wizard to create a site-to-site VPN between a ZyWALL/USG and an Amazon VPC platform. The example instructs how to configure the VPN tunnel between each site. When the VPN tunnel is configured, each site can be accessed securely.

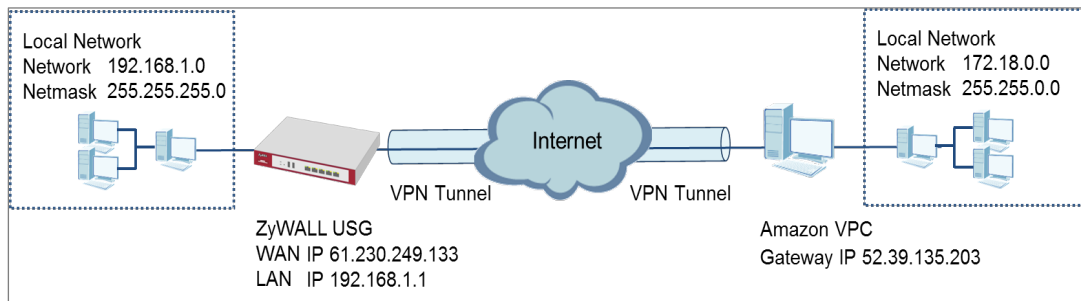

ZyWALL/USG Site-to-site IPSec VPN with Amazon VPC

 **Note:**

All network IP addresses and subnet masks are used as examples in this article. Please replace them with your actual network IP addresses and subnet masks. This example was tested using USG110 (Firmware Version: ZLD 4.25) and Amazon VPC (June, 2016).

## Set Up the IPsec VPN Tunnel on the Amazon VPC

- 1 Sign into the Amazon AWS Management Console. Go to Networking > VPC.

### Amazon AWS Management Console > Networking > VPC

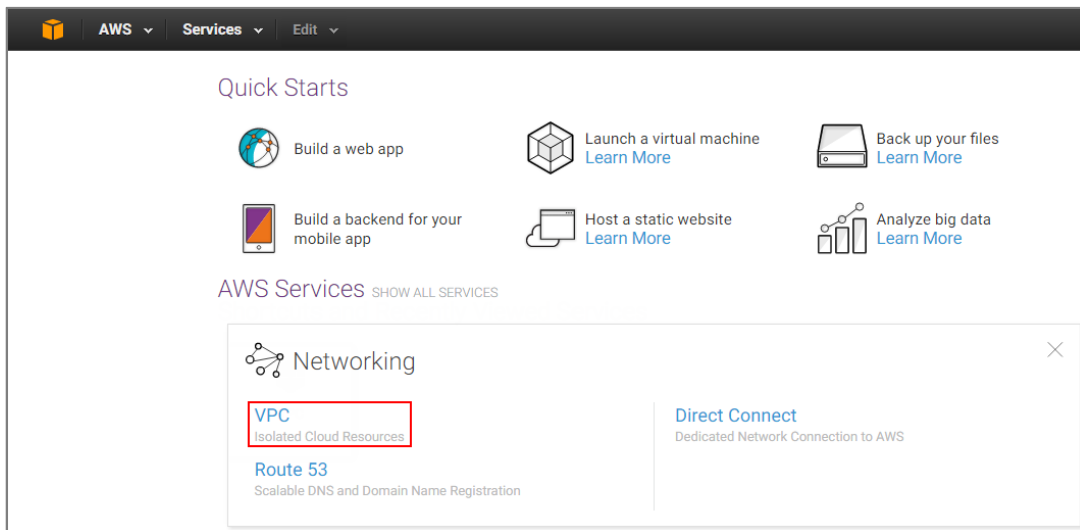

- 2 In the upper left-hand of the screen, click **Start VPC Wizard**.

### Amazon VPC Management Console > Networking > VPC > Start VPC Wizard

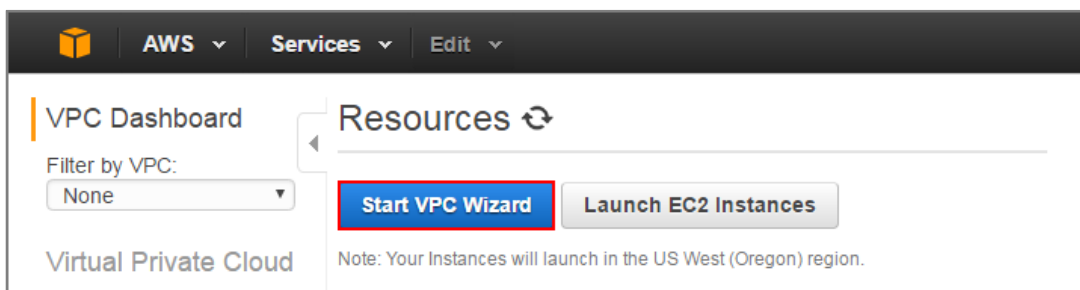

- 3 Select a VPC Configuration, select VPC with a Private Subnet Only and Hardware VPN Access, and then click Select.

## Select a VPC Configuration > VPC with a Private Subnet Only and Hardware VPN Access

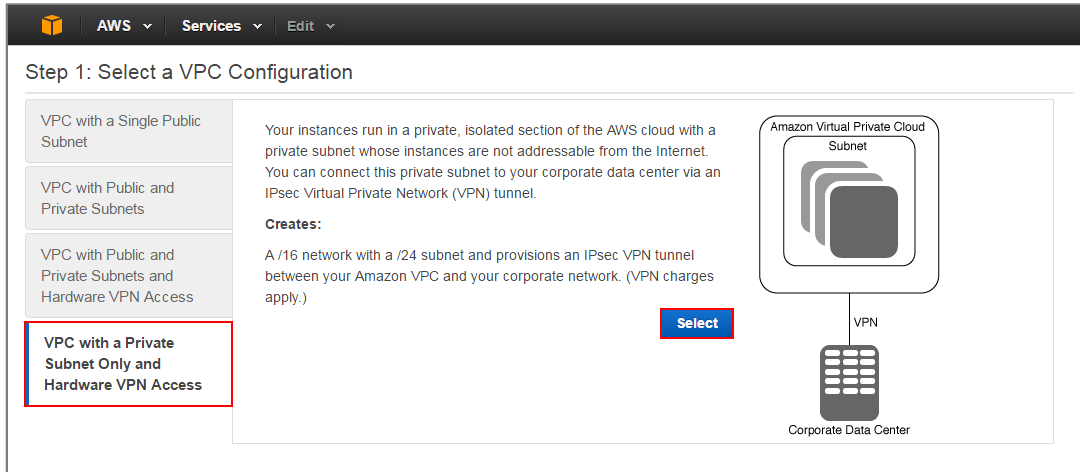

- 4 VPC with a Private Subnet Only and Hardware VPN, add your **IP CIDR block** and **Private subnet**. Click **Next**.

## VPC with a Private Subnet Only and Hardware VPN

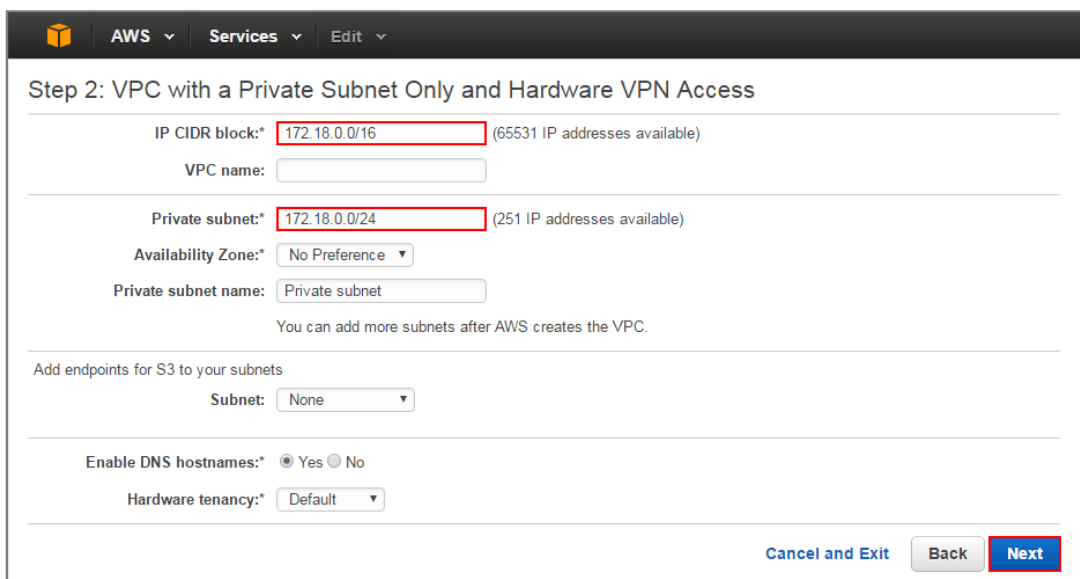

- Configure your VPN, add your ZyWALL/USG public IP address into **Customer Gateway IP**. Name your **Customer Gateway name** and **VPN Connection name**.  
Click **Create VPC** at the bottom of the blade.

## Configure your VPN

**Step 3: Configure your VPN**

Specify the public IP Address of your VPN router (Customer Gateway)

Customer Gateway IP:\* 61.230.249.133

Customer Gateway name: GW\_to\_ZyWALL/USG

VPN Connection name: CN\_to\_ZyWALL/USG

Note: VPN Connection rates apply.

Specify the routing for the VPN Connection (Help me choose)

Routing Type:\* Dynamic (requires BGP)

Cancel and Exit Back **Create VPC**

**Step 3: Configure your VPN**

Specify the public IP Address of your VPN router (Customer Gateway)

Customer Gateway IP:\* 61.230.249.133

Customer Gateway name: GW\_to\_ZyWALL/USG

VPN Connection name: CN\_to\_ZyWALL/USG

Note: VPN Connection rates apply.

Specify the routing for the VPN Connection (Help me choose)

Routing Type:\* Dynamic (requires BGP)

Creating VPN (This may take a few minutes)... 47%

Cancel and Exit Back **Create VPC**

- In the VPC Dashboard, go to VPN Connections. Select Download Configuration from the upper bar. Select Vendor and Platform to be Generic. Click Yes, Download.

## VPC Dashboard > VPN Connections

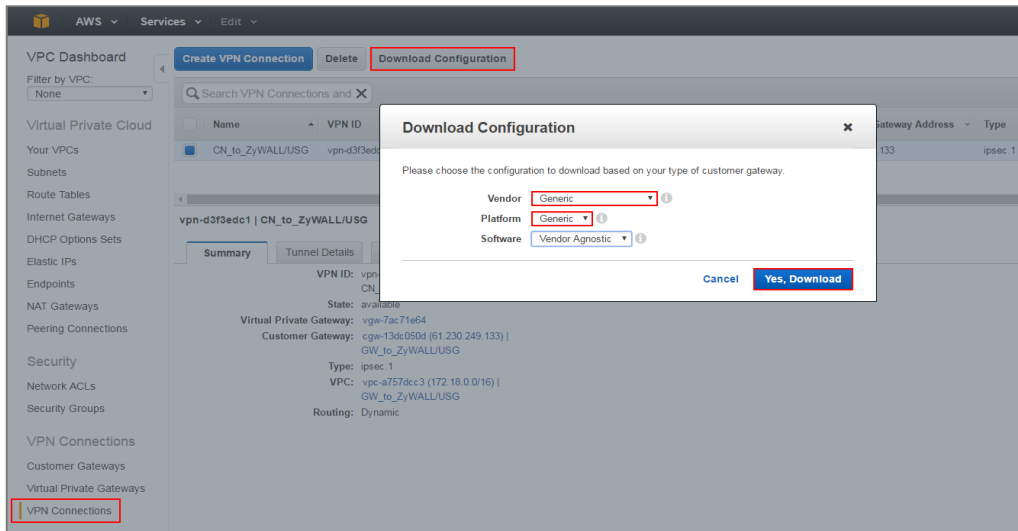

- 7 Open the downloaded configuration txt. file, it displays IKE SA, IPsec SA and Gateway IP address. Please make sure all the settings match your ZyWALL/USG's setting.

### Configuration txt. File

```

IPSec Tunnel #1
-----
#1: Internet Key Exchange Configuration
Configure the IKE SA as follows:
- Authentication Method      : Pre-Shared Key
- Pre-Shared Key            : 2EhrEA5WI6QFMEBaaPZT1bBmnoUaCLhW
- Authentication Algorithm  : sha1
- Encryption Algorithm      : aes-128-cbc
- Lifetime                  : 28800 seconds
- Phase 1 Negotiation Mode  : main
- Perfect Forward Secrecy   : Diffie-Hellman Group 2

#2: IPSec Configuration
Configure the IPSec SA as follows:
- Protocol                  : esp
- Authentication Algorithm  : hmac-sha1-96
- Encryption Algorithm      : aes-128-cbc
- Lifetime                  : 3600 seconds
- Mode                      : tunnel
- Perfect Forward Secrecy   : Diffie-Hellman Group 2

IPSec Dead Peer Detection (DPD) will be enabled on the AWS Endpoint. We
recommend configuring DPD on your endpoint as follows:
- DPD Interval              : 10
- DPD Retries               : 3

#3: Tunnel Interface Configuration
Outside IP Addresses:
- Customer Gateway         : 61.230.249.133
- Virtual Private Gateway  : 52.39.135.203
    
```

## Set Up the IPSec VPN Tunnel on the ZyWALL/USG

In the ZyWALL/USG, go to **Quick Setup > VPN Setup Wizard**, use the **VPN Settings** wizard to create a VPN rule that can be used with the Amazon VPC. Click **Next**.

Quick Setup > **VPN Setup Wizard > Welcome**

**VPN Setup Wizard**

Wizard Type > VPN Settings > Wizard Completed  
1 2 3

**Welcome**

- VPN Settings
  - Wizard Type
  - VPN Settings
  - Wizard Completed
- VPN Settings for Configuration Provisioning
  - Wizard Type
  - VPN Settings
  - Wizard Completed
- VPN Settings for L2TP VPN Settings
  - VPN Settings
  - General Settings
  - Wizard Completed

Choose **Advanced** to create a VPN rule with the customize phase 1, phase 2 settings and authentication method. Click **Next**.

**Quick Setup > VPN Setup Wizard > Welcome > Wizard Type**

**VPN Setup Wizard**

Wizard Type > VPN Settings > Wizard Completed  
1 2 3

**Please select the type of VPN policy you wish to setup.**

**Type of VPN policy**

- Express
- Advanced

Type the **Rule Name** used to identify this VPN connection (and VPN gateway). You may use 1-31 alphanumeric characters. This value is case-sensitive. Select the rule to be **Site-to-site**. Click **Next**.

**Quick Setup > VPN Setup Wizard > Wizard Type > VPN Settings (Scenario)**



**VPN Setup Wizard**

Wizard Type > **VPN Settings** > Wizard Completed

1      2      3

**Advanced Settings**

**IKE Version**

IKEv1

IKEv2

**Scenario**

Rule Name:

Site-to-site

Site-to-site with Dynamic Peer

Remote Access (Server Role)

Remote Access (Client Role)

Then, configure the **Secure Gateway** IP as the peer Amazon VPC's Gateway IP address (in the example, 52.39.135.203); select **My Address** to be the interface connected to the Internet.

Set the **Negotiation, Encryption, Authentication, Key Group** and **SA Life Time** which Amazon VPC supports. Type a secure **Pre-Shared Key**.

Quick Setup > **VPN Setup Wizard** > **Welcome** > **Wizard Type** > **VPN Settings (Phase 1 Setting)**

**VPN Setup Wizard**

Wizard Type > **VPN Settings** > Wizard Completed

1 2 3

**Advanced Settings**

**Phase 1 Setting**

Secure Gateway:  (IP or FQDN)

My Address (interface):

Negotiation Mode:

Encryption Algorithm:

Authentication Algorithm:

Key Group:

SA Life Time:  (180 - 3000000 seconds)

NAT Traversal

Dead Peer Detection (DPD)

**Authentication Method**

Pre-Shared Key

Certificate

Continue to Phase 2 Settings to select the **Encapsulation**, **Encryption**, **Authentication**, and **SA Life Time** settings which Amazon VPC supports. Set **Local Policy** to be the IP address range of the network connected to the ZyWALL/USG and **Remote Policy** to be the IP address range of the network connected to the Amazon VPC. Click **OK**.

Quick Setup > VPN Setup Wizard > Welcome > Wizard Type > VPN Settings

## (Phase 2 Setting)

### VPN Setup Wizard

Wizard Type > **VPN Settings** > Wizard Completed

1 2 3

#### Advanced Settings

##### Phase 2 Setting

Active Protocol: ESP

Encapsulation: Tunnel

Encryption Algorithm: AES128

Authentication Algorithm: SHA1

SA Life Time: 86400 (180 - 3000000 seconds)

Perfect Forward Secrecy (PFS): None

##### Policy Setting

Local Policy (IP/Mask): 192.168.1.0 / 255.255.255.0

Remote Policy (IP/Mask): 172.18.0.0 / 255.255.0.0

##### Property

Nailed-Up

Quick Setup > VPN Setup Wizard > Welcome > Wizard Type > VPN Settings

**(Summary)**

Wizard Type > **VPN Settings** > Wizard Completed

1
2
3

**Advanced Settings**

**Summary**

Rule Name:	VPN_to_VPC
Secure Gateway:	52.39.135.203
Pre-Shared Key:	12345678
Local Policy (IP/Mask):	192.168.1.0 / 255.255.255.0
Remote Policy (IP/Mask):	172.18.0.0 / 255.255.255.0

**Phase 1**

Negotiation Mode:	main
Encryption Algorithm:	aes128
Authentication Algorithm:	sha
Key Group:	DH2

**Phase 2**

Active Protocol:	esp
Encapsulation:	tunnel
Encryption Algorithm:	aes128
Authentication Algorithm:	sha

Now the rule is configured on the ZyWALL/USG. The Phase 1 rule settings appear in the **VPN > IPSec VPN > VPN Gateway** screen and the Phase 2 rule settings appear in the **VPN > IPSec VPN > VPN Connection** screen. Click **Close** to exit the wizard.

Quick Setup > VPN Setup Wizard > Welcome > Wizard Type > VPN Settings > Wizard Completed

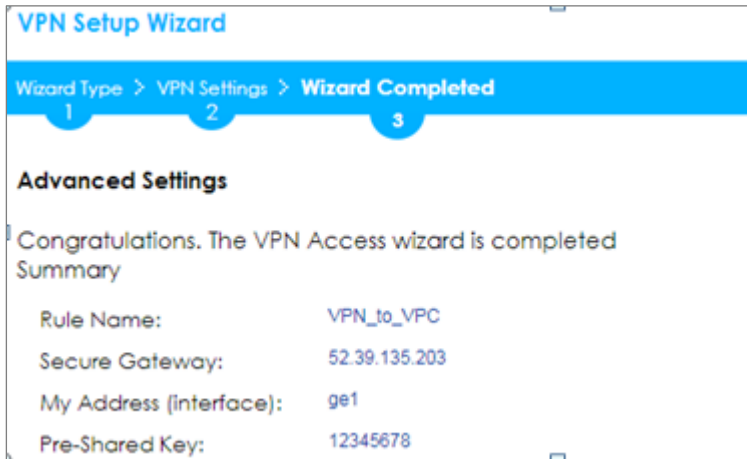

## Test the IPsec VPN Tunnel

Go to ZyWALL/USG **CONFIGURATION > VPN > IPsec VPN > VPN Connection**, click **Connect** on the upper bar. The **Status** connect icon is lit when the interface is connected.

### CONFIGURATION > VPN > IPsec VPN > VPN Connection

#	Status	Name	VPN Gateway	Gateway IP	Version	Policy
1		VPN_to_Azure	VPN_to_Azure	IPv4		VPN_to_VPC_LOCAL/VPN_to_VPC_REMOTE

Go to ZyWALL/USG **MONITOR > VPN Monitor > IPsec** and verify the tunnel **Up Time** and the **Inbound(Bytes)/Outbound(Bytes)** traffic.

### MONITOR > VPN Monitor > IPsec

#	Name	Policy	My Address	Secure Gateway	Up Time	Timeout	Inbound(B...	Outbound...
1	WIZ_VPN_VPC	192.168.1.0/24<>172.18.0.0/24	61.230.249.133	P: 52.39.135.203:4500	28	76292	0(0 bytes)	0(0 bytes)

To test whether or not a tunnel is working, ping from a Local LAN to AWS VPC private Subnet for verification. Ensure that both computers have Internet access.

**Ping from Local LAN to AWS VPC private Subnet for verification:**

```
C:\Documents and Settings\ZyXEL>ping 172.18.0.15

Pinging 172.18.0.15 with 32 bytes of data:

Reply from 172.18.0.15 : bytes=32 time=27ms TTL=43
Reply from 172.18.0.15 : bytes=32 time=32ms TTL=43
Reply from 172.18.0.15 : bytes=32 time=26ms TTL=43
Reply from 172.18.0.15 : bytes=32 time=27ms TTL=43

Ping statistics for 172.18.0.15 :
    Packets: Sent = 4, Received = 4, Lost = 0 (0% loss),
    Approximate round trip times in milli-seconds:
        Minimum = 26ms, Maximum = 32ms, Average = 28ms
```

## What Could Go Wrong?

If you see below [info] or [error] log message, please check ZyWALL/USG Phase 1 Settings. Make sure your ZyWALL/USG Phase 1 Settings are supported in the Amazon VPC IKE Phase 1 setup list.

**MONITOR > Log**

Priority	Category	Message	Note
info	IKE	Recv:[NOTIFY:INVALID_COOKIE]	IKE_LOG
info	IKE	Send:[ID][HASH][NOTIFY:INITIAL_CONTACT]	IKE_LOG
Priority	Category	Message	Note
error	IPSec	SPI: 0x0 (0) SEQ: 0x0 (0) No rule found, Dropping TCP packet	IPSec
error	IPSec	SPI: 0x0 (0) SEQ: 0x0 (0) No rule found, Dropping TCP packet	IPSec
info	IKE	[COOKIE] Invalid cookie, no sa found	IKE_LOG
Priority	Category	Message	Note
info	IKE	Recv:[HASH][NOTIFY:NO_PROPOSAL_CHOSEN]	IKE_LOG

If you see that Phase 1 IKE SA process done but still get below [info] log message, please check ZyWALL/USG Phase 2 Settings. Make sure your ZyWALL/USG Phase 2 Settings are supported in the Amazon VPC IKE Phase 2 setup list.

**MONITOR > Log**

123	2017-09-11 10:1...	info	IKE	Recv:[HASH][SA][NONCE][ID][ID]	IKE_LOG
127	2017-09-11 10:1...	info	IKE	Phase 1 IKE SA process done	IKE_LOG

## How to Configure Site-to-site IPSec VPN with Microsoft (MS) Azure

This example shows how to use the VPN Setup Wizard to create a site-to-site VPN between a ZyWALL/USG and a Microsoft (MS) Azure platform. The example instructs how to configure the VPN tunnel between each site. When the VPN tunnel is configured, each site can be accessed securely.

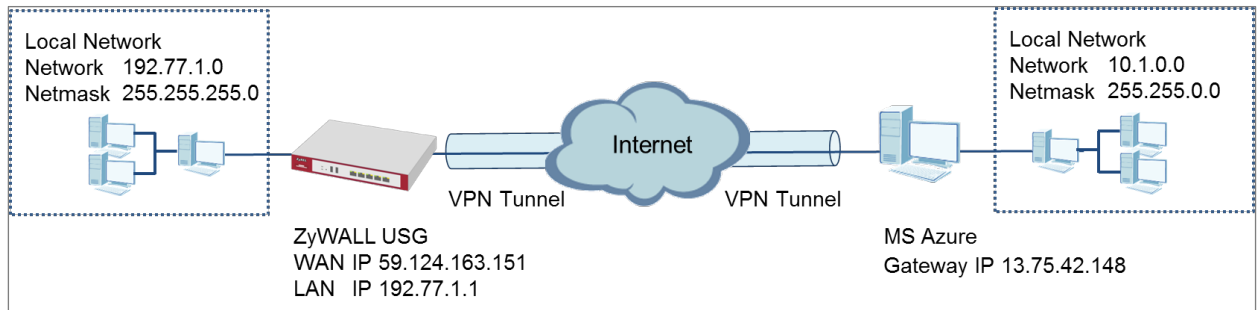

ZyWALL Site-to-site IPSec VPN with Microsoft (MS) Azure

 Note:

1. All network IP addresses and subnet masks are used as examples in this article. Please replace them with your actual network IP addresses and subnet masks. This example was tested using USG40 (Firmware Version: ZLD 4.25) and MS Azure (April, 2016).

## Set Up the IPSec VPN Tunnel on the ZyWALL/USG

In the ZyWALL/USG, go to **Quick Setup > VPN Setup Wizard**, use the **VPN Settings** wizard to create a VPN rule that can be used with the MS Azure. Click **Next**.

### Quick Setup > VPN Setup Wizard > Welcome

VPN Setup Wizard

Wizard Type > VPN Settings > Wizard Completed

1 2 3

**Welcome**

- VPN Settings
  - Wizard Type
  - VPN Settings
  - Wizard Completed
- VPN Settings for Configuration Provisioning
  - Wizard Type
  - VPN Settings
  - Wizard Completed
- VPN Settings for L2TP VPN Settings
  - VPN Settings
  - General Settings
  - Wizard Completed

Choose **Advanced** to create a VPN rule with the customize phase 1, phase 2 settings and authentication method. Click **Next**.

### Quick Setup > VPN Setup Wizard > Welcome > Wizard Type

VPN Setup Wizard

Wizard Type > VPN Settings > Wizard Completed

1 2 3

**Please select the type of VPN policy you wish to setup.**

**Type of VPN policy**

- Express
- Advanced



Type the **Rule Name** used to identify this VPN connection (and VPN gateway). You may use 1-31 alphanumeric characters. This value is case-sensitive. Select the rule to be **Site-to-site**. Click **Next**.

**Quick Setup > VPN Setup Wizard > Wizard Type > VPN Settings (Scenario)**

**VPN Setup Wizard**

Wizard Type > **VPN Settings** > Wizard Completed

1 2 3

**Advanced Settings**

**IKE Version**

IKEv1

IKEv2

**Scenario**

Rule Name:

Site-to-site

Site-to-site with Dynamic Peer

Remote Access (Server Role)

Remote Access (Client Role)

Then, configure the **Secure Gateway** IP as the peer MS Azure's Gateway IP address (in the example, 13.75.42.148); select **My Address** to be the interface connected to the Internet.

Set the **Negotiation, Encryption, Authentication, Key Group** and **SA Life Time** which MS Azure supports. Please make sure you disable **Dead Peer Detection (DPD)** which is not supported in the MS Azure IKEv1 Policy-based. Type a secure **Pre-Shared Key**.

Quick Setup > VPN Setup Wizard > Welcome > Wizard Type > VPN Settings (Phase 1 Setting)

VPN Setup Wizard

Wizard Type > VPN Settings > Wizard Completed

1 2 3

### Advanced Settings

#### Phase 1 Setting

Secure Gateway:  (IP or FQDN)

My Address (interface):

Negotiation Mode:

Encryption Algorithm:

Authentication Algorithm:

Key Group:

SA Life Time:  (180 - 3000000 seconds)

NAT Traversal

Dead Peer Detection (DPD)

#### Authentication Method

Pre-Shared Key

Certificate

 Note: For more information about the IPsec Parameters supported in MS Azure, see the Microsoft Azure Documentation [About VPN devices](#) for Site-to-Site VPN Gateway connections.

Continue to Phase 2 Settings to select the **Encapsulation, Encryption, Authentication**, and **SA Life Time** settings which MS Azure supports.

Set **Local Policy** to be the IP address range of the network connected to the ZyWALL/USG and **Remote Policy** to be the IP address range of the network connected to the MS Azure. Click **OK**.

**Quick Setup > VPN Setup Wizard > Welcome > Wizard Type > VPN Settings (Phase 2 Setting)**

**VPN Setup Wizard**

Wizard Type > **VPN Settings** > Wizard Completed

1      2      3

**Advanced Settings**

**Phase 2 Setting**

Active Protocol: ESP

Encapsulation: Tunnel

Encryption Algorithm: AES128

Authentication Algorithm: SHA1

SA Life Time: 86400 (180 - 3000000 seconds)

Perfect Forward Secrecy (PFS): None

**Policy Setting**

Local Policy (IP/Mask): 192.77.1.0 / 255.255.255.0

Remote Policy (IP/Mask): 10.1.0.0 / 255.255.0.0

**Property**

Nailed-Up

 **Note:** For more information about the IPsec Parameters supported in MS Azure, see the Microsoft Azure Documentation [About VPN devices](#) for Site-to-Site VPN Gateway connections.

This screen provides a read-only summary of the VPN tunnel. Click **Save**.

**Quick Setup > VPN Setup Wizard > Welcome > Wizard Type > VPN Settings  
(Summary)**

Wizard Type > **VPN Settings** > Wizard Completed

1 2 3

**Advanced Settings**

**Summary**

Rule Name: VPN\_to\_Azure

Secure Gateway: 13.75.42.148

Pre-Shared Key: 12345678

Local Policy (IP/Mask): 192.77.1.0 / 255.255.255.0

Remote Policy (IP/Mask): 10.1.0.0 / 255.255.0.0

**Phase 1**

Negotiation Mode: main

Encryption Algorithm: aes128

Authentication Algorithm: sha

Key Group: DH2

**Phase 2**

Active Protocol: esp

Encapsulation: tunnel

Encryption Algorithm: aes128

Now the rule is configured on the ZyWALL/USG. The Phase 1 rule settings appear in the **VPN > IPSec VPN > VPN Gateway** screen and the Phase 2 rule settings appear in the **VPN > IPSec VPN > VPN Connection** screen. Click **Close** to exit the wizard.

Quick Setup > VPN Setup Wizard > Welcome > Wizard Type > VPN Settings > Wizard Completed

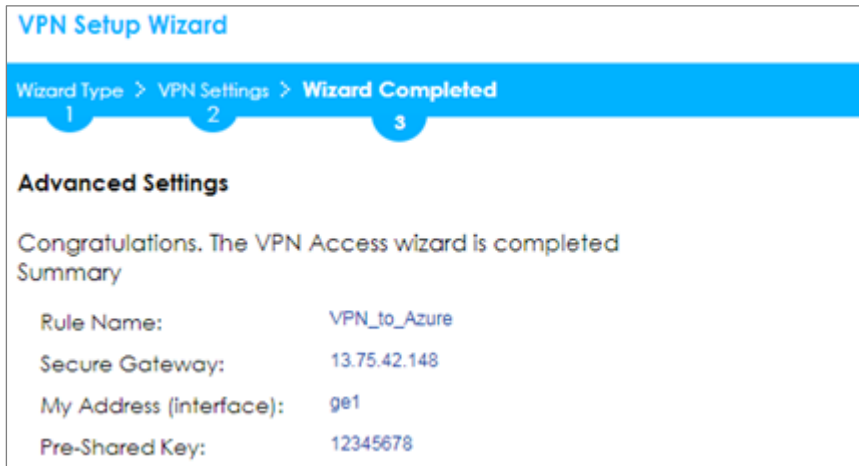

## Set Up the IPSec VPN Tunnel on the MS Azure

Sign into the **Windows Azure Management Portal**. In the upper left-hand corner of the screen, click **+New > Networking > Virtual Network**.

Azure portal > New > Networking > Virtual Network

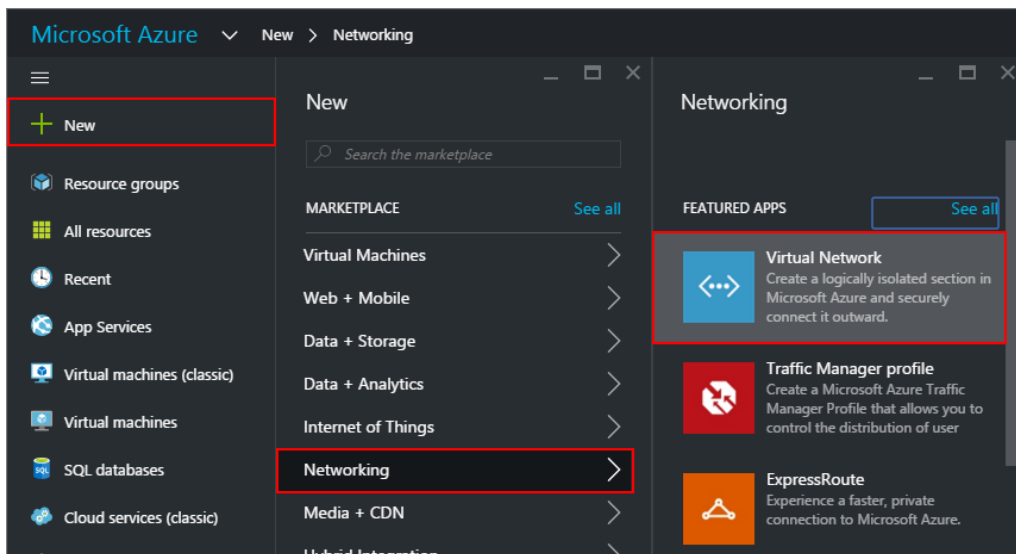

Near the bottom of the **Virtual Network** blade, from the **Select a deployment model** list, select **Resource Manager**, and then click **Create**.

**New > Networking > Virtual Network > Select a deployment model**

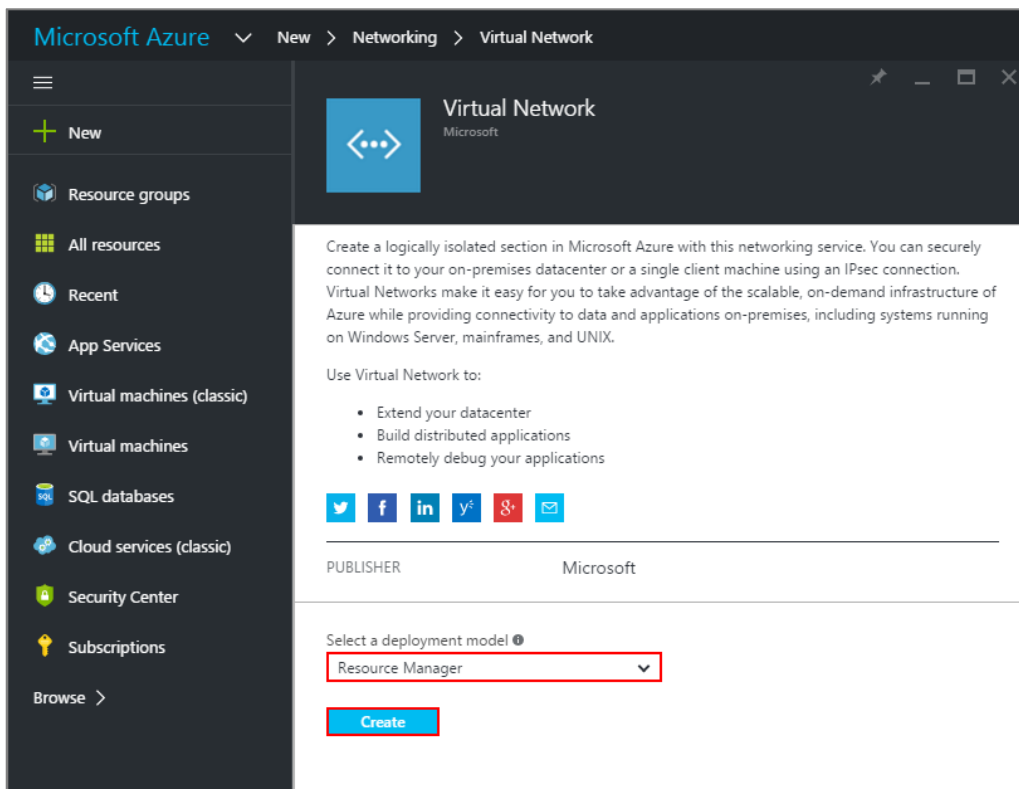

On the **Create virtual network** page, enter the **NAME** for the VPN network. For example, **VPN\_Vnet\_to\_USG**. Add your **Address Space**, **Subnet name** and a single **Subnet address range**.

Click **Resource group** and either select an existing resource group, or create a new one by typing a name for your new resource group. For example, **RG\_USG**.

**LOCATION** is directly related to the physical location (region) where the virtual machines (VMs) reside. The region associated with the virtual network cannot be changed after it has been created.

Then, click the **Create** button. After clicking Create, you will see a tile on your dashboard that will reflect the progress of your VNet. The tile will change as the VNet is being created.

**New > Networking > Virtual Network > Create virtual network**

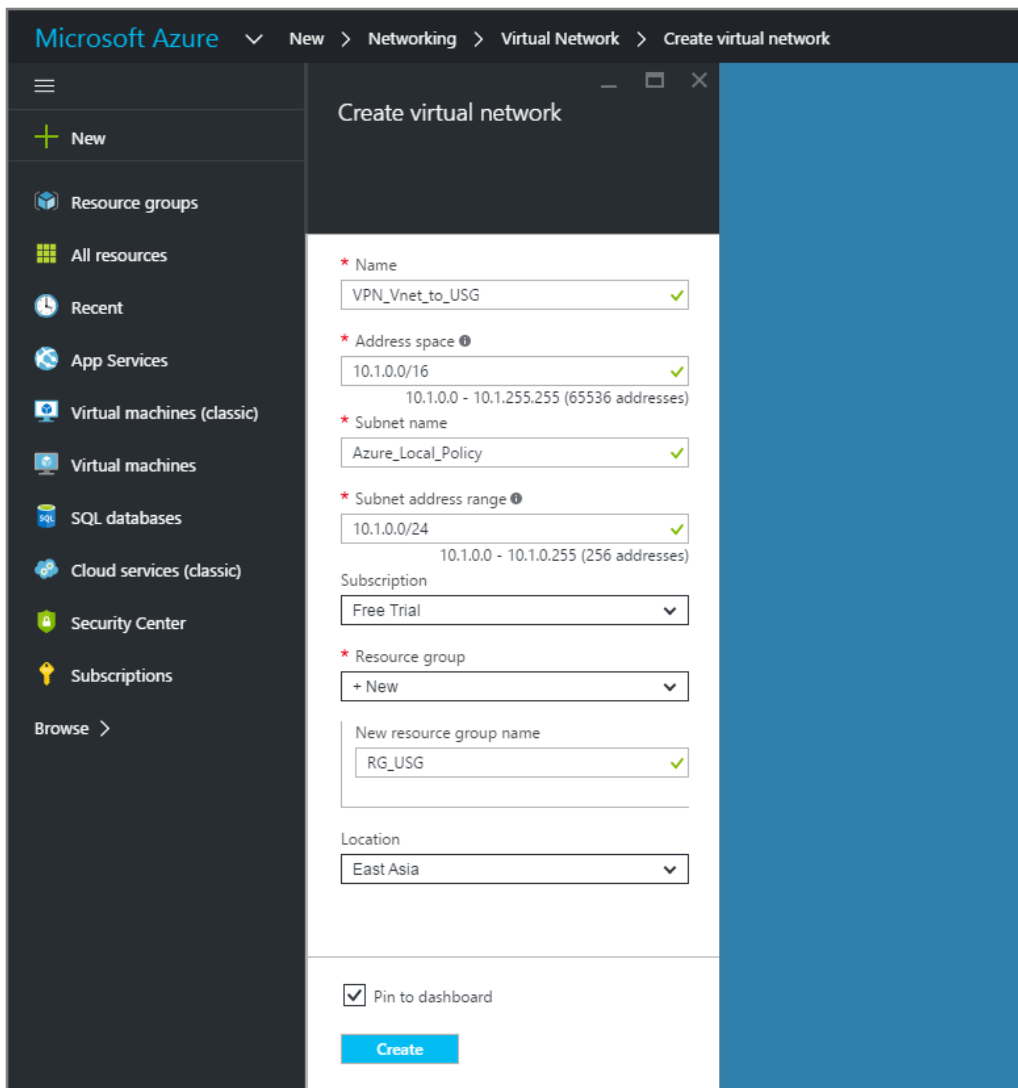

In the portal, navigate to the virtual network to which you just created. On the blade for your virtual network, click the **Settings** icon at the top of the blade to expand the Setting blade to **Subnets > Add > Add Subnet**. **Name** your subnet

**GatewaySubnet.** You should not name it anything else, or the gateway will not work. Add the IP **Address range** for your gateway. Click **OK** at the bottom of the blade to create the subnet.

## VPN Vnet\_to\_USG > Settings > Subnet > Add subnet

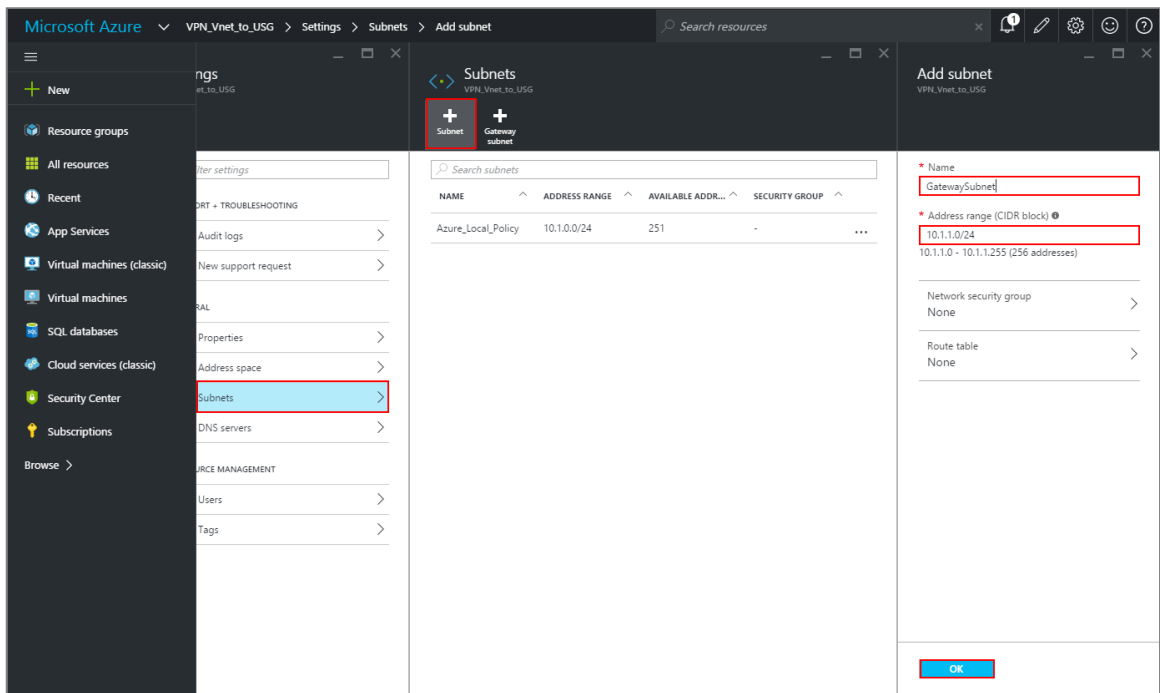

In the portal, go to **New**, then Networking. Select **Virtual network gateway** from the list. On the **Create virtual network gateway** blade **Name** field, name your gateway. Next, choose the **Virtual network** that you want to deploy this gateway to.

Click the arrow (>) to open the **Choose public IP address** blade. Then click **Create New** to open the **Create public IP address** blade. Input a **Name** for your public IP address. Note that this is not asking for an IP address. The IP address will be assigned dynamically. Rather, this is the name of the IP address object that the address will be assigned to. Click **OK** to save your changes.



For **Gateway type**, select **VPN**. For **VPN type**, select **Policy-based**. For **Resource Group**, the resource group is determined by the Virtual Network that you select. For **Location**, make sure it's showing the location that both your Resource Group and VNet exist in.

**New > Networking > Create virtual network gateway > Choose public IP address > Create public IP address**

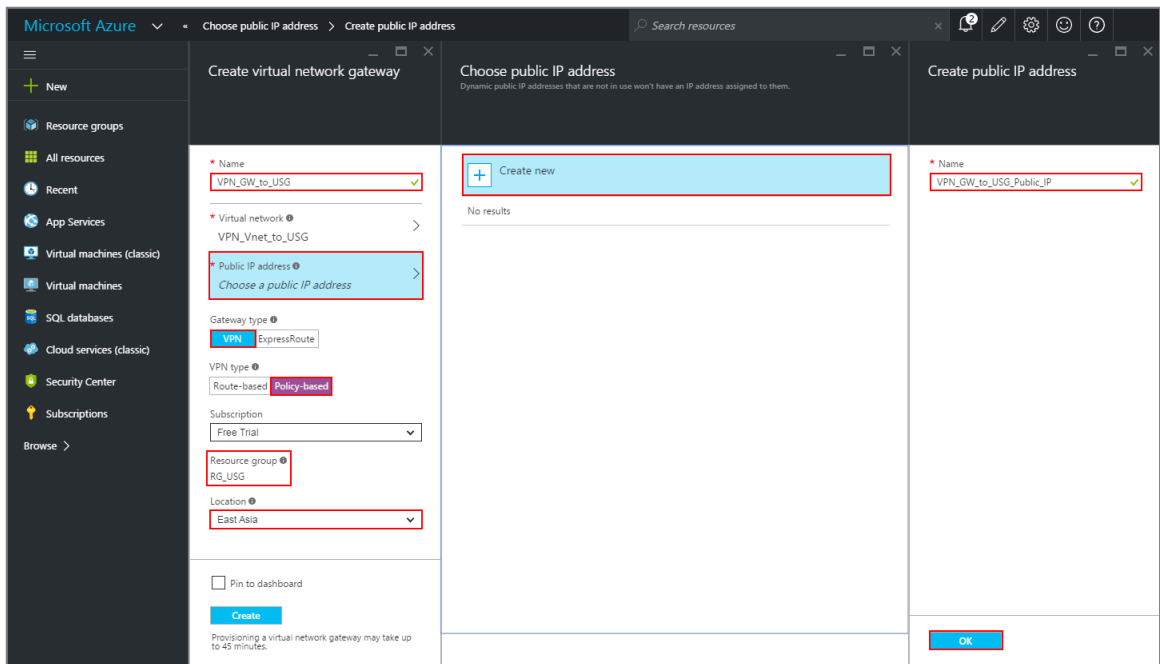

In the Azure Portal, navigate to **New > Networking > Local network gateway**. The local network gateway refers to your ZyWALL/USG public IP and local subnet settings.

On the **Create local network gateway** blade, specify a **Name** for your ZyWALL/USG gateway object.

Specify public IP address of your ZyWALL/USG. It cannot be behind NAT and has to be reachable by Azure. **Address space** refers to the address ranges on your ZyWALL/USG local network. For **Resource Group**, select the resource group that you created before. For **Location**, if you are creating a new local network

gateway, you can use the same location as the virtual network gateway. But, this is not required. The local network gateway can be in a different location.

Click **Create** to create the local network gateway.

## New > Networking > Local network gateway

The screenshot shows the 'Create local network gateway' form in the Microsoft Azure portal. The breadcrumb navigation is 'New > Networking > Create local network gateway'. The left sidebar contains navigation options: New, Resource groups, All resources, Recent, App Services, Virtual machines (classic), Virtual machines, SQL databases, Cloud services (classic), Security Center, and Subscriptions. The main form fields are: Name (VPN\_Connection\_to\_USG), IP address (59.124.163.151), Address space (192.77.1.0/24), Subscription (Free Trial), Resource group (RG\_USG), and Location (East Asia). A 'Pin to dashboard' checkbox is checked, and a 'Create' button is at the bottom.

Microsoft Azure > New > Networking > Create local network gateway

### Create local network gateway

\* Name  
VPN\_Connection\_to\_USG ✓

\* IP address ⓘ  
59.124.163.151 ✓

Address space ⓘ  
192.77.1.0/24 ...  
*Add additional address range* ...

Subscription  
Free Trial ▾

\* Resource group ⓘ  
RG\_USG ▾

Location  
East Asia ▾

Pin to dashboard

**Create**

Locate your virtual network gateway (VPN\_Connection\_to\_USG in this example) and click **Settings > Connection > Add connection**, **Name** your connection. For **Connection type**, select **Site-to-site (IPSec)**. For **Virtual network gateway**, the value is fixed because you are connecting from this gateway (VPN\_GW\_to\_USG in this example).

For **Local network gateway**, select the local network gateway that you want to use (VPN\_Connection\_to\_USG in this example).

For **Shared Key (PSK)**, the value here must match the value that you are using for your ZyWALL/USG device. For **Resource Group**, select the resource group that you **created before**. Click **OK** to create your connection.

## VPN\_Connection\_to\_USG > Settings > Connections > Add connection

The screenshot displays the 'Add connection' configuration page in the Microsoft Azure portal. The breadcrumb navigation shows the path: Microsoft Azure > VPN\_Connection\_to\_USG > Settings > Connections > Add connection. The page is divided into a left sidebar with navigation options (New, Resource groups, All resources, Recent, App Services, Virtual machines (classic), Virtual machines, SQL databases, Cloud services (classic), Security Center, Subscriptions, Browse) and a main content area. The main content area is split into two panes: 'Connections' (showing a search bar and a table with columns NAME, STATUS, CONNECTION TYPE, and VIRTUAL NETWORK...) and 'Add connection' (the configuration form). The configuration form includes the following fields:

- Name:** Azure\_Vnet\_USG (checked)
- Connection type:** Site-to-site (IPsec)
- Virtual network gateway:** VPN\_GW\_to\_USG
- Local network gateway:** VPN\_Connection\_to\_USG
- Shared key (PSK):** zyxel1234 (checked)
- Subscription:** Free Trial
- Resource group:** RG\_USG
- Location:** East Asia

An 'OK' button is located at the bottom of the configuration form.

When the connection is complete, you'll see it appear in the **Connections** blade for your Gateway.

## VPN\_Connection\_to\_USG > Settings > Connections

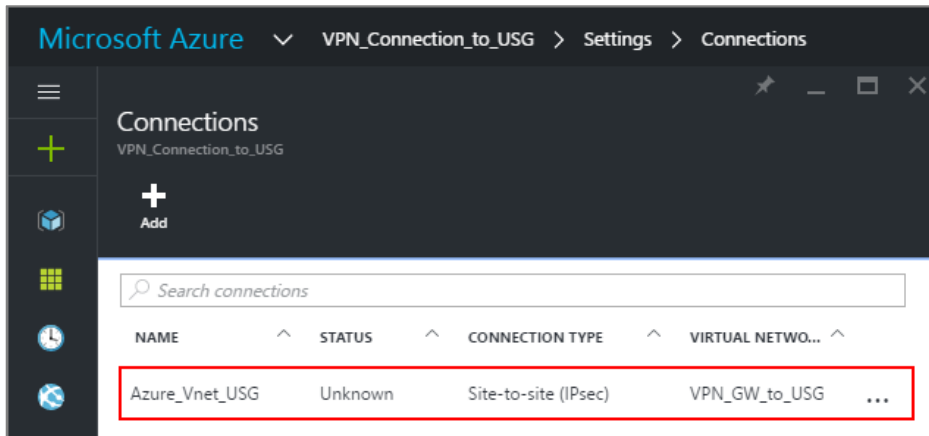

## Test the IPsec VPN Tunnel

Go to ZyWALL/USG **CONFIGURATION > VPN > IPsec VPN > VPN Connection**, click **Connect** on the upper bar. The **Status** connect icon is lit when the interface is connected.

## CONFIGURATION > VPN > IPsec VPN > VPN Connection

#	Status	Name	VPN Gateway	Gateway IP Version	Policy
1		VPN_to_Azure	VPN_to_Azure	IPv4	VPN_to_Azure_LOCAL/VPN_to_Azure_REMOTE

Go to ZyWALL/USG **MONITOR > VPN Monitor > IPSec** and verify the tunnel **Up Time** and the **Inbound(Bytes)/Outbound(Bytes)** traffic.

**MONITOR > VPN Monitor > IPSec**

#	Name	Policy	My Address	Secure Gateway	Up Time	Timeout	Inbound(B...	Outbound...
1	WIZ_VPN_Azure	192.77.1.0/24<>10.1.0.0/16	59.124.163.151	P: 13.75.42.148:4500	14	86406	0(0 bytes)	0(0 bytes)

Page 1 of 1 Show 50 items Displaying 1 - 1 of 1

Go to **Azure\_Vnet\_USG > Settings** to check the tunnel **DATA IN** and **DATA OUT**.

**VPN > VPN Settings > Currently Active VPN Tunnels**

The screenshot shows the Microsoft Azure portal interface for the 'Azure\_Vnet\_USG' connection. The breadcrumb path is 'Microsoft Azure > Azure\_Vnet\_USG > Settings'. The connection name is 'Azure\_Vnet\_USG' and its status is 'Connected'. The 'Essentials' section displays the following details:

- Resource group: [RG\\_USG](#)
- Status: **Connected**
- Location: **East Asia**
- Subscription name: **Free Trial**
- Subscription ID: **23a31ce5-c9fa-4da3-958b-8bb1b6fe8790**
- Data in: **0 B**
- Data out: **576 B**
- Virtual network: [VPN\\_Vnet\\_to\\_USG](#)
- Virtual network gateway: [VPN\\_GW\\_to\\_USG \(13.75.42.148\)](#)
- Local network gateway: [VPN\\_Connection\\_to\\_USG \(59.124.163.151\)](#)

An 'All settings' button is located at the bottom right of the Essentials section.

To test whether or not a tunnel is working, ping from a computer at one site to a computer at the other. Ensure that both computers have Internet access.

**PC behind ZyWALL/USG > Window 7 > cmd > ping 10.1.0.33**

```
C:\Documents and Settings\ZyXEL>ping 10.1.0.33

Pinging 10.1.0.33 with 32 bytes of data:

Reply from 10.1.0.33 : bytes=32 time=18ms TTL=54
Reply from 10.1.0.33 : bytes=32 time=17ms TTL=54
Reply from 10.1.0.33 : bytes=32 time=17ms TTL=54
Reply from 10.1.0.33 : bytes=32 time=16ms TTL=54

Ping statistics for 10.1.0.33 :
    Packets: Sent = 4, Received = 4, Lost = 0 (0% loss),
    Approximate round trip times in milli-seconds:
        Minimum = 16ms, Maximum = 18ms, Average = 17ms
```

**PC behind MS Azure> Window 7 > cmd > ping 192.77.1.33**

```
C:\Documents and Settings\ZyXEL>ping 192.77.1.33

Pinging 192.77.1.33 with 32 bytes of data:

Reply from 192.77.1.33 : bytes=32 time=27ms TTL=43
Reply from 192.77.1.33 : bytes=32 time=32ms TTL=43
Reply from 192.77.1.33 : bytes=32 time=26ms TTL=43
Reply from 192.77.1.33 : bytes=32 time=27ms TTL=43

Ping statistics for 192.77.1.33 :
    Packets: Sent = 4, Received = 4, Lost = 0 (0% loss),
    Approximate round trip times in milli-seconds:
        Minimum = 26ms, Maximum = 32ms, Average = 28ms
```

## What Could Go Wrong?

If you see below [info] or [error] log message, please check ZyWALL/USG Phase 1 Settings. Make sure your ZyWALL/USG Phase 1 Settings are supported in the MS Azure IKE Phase 1 setup list.

### MONITOR > Log

Priority	Category	Message	Note
info	IKE	Recv:[NOTIFY:INVALID_COOKIE]	IKE_LOG
info	IKE	Send:[ID][HASH][NOTIFY:INITIAL_CONTACT]	IKE_LOG
Priority	Category	Message	Note
error	IPSec	SPI: 0x0 (0) SEQ: 0x0 (0) No rule found, Dropping TCP packet	IPSec
error	IPSec	SPI: 0x0 (0) SEQ: 0x0 (0) No rule found, Dropping TCP packet	IPSec
info	IKE	[COOKIE] Invalid cookie, no sa found	IKE_LOG
Priority	Category	Message	Note
info	IKE	Recv:[HASH][NOTIFY:NO_PROPOSAL_CHOSEN]	IKE_LOG

If you see that Phase 1 IKE SA process done but still get below [info] log message, please check ZyWALL/USG Phase 2 Settings. Make sure your ZyWALL/USG Phase 2 Settings are supported in the MS Azure IKE Phase 2 setup list.

### MONITOR > Log

19	2017-09-11 ...	info	IKE	[SA] : No proposal chosen	IKE_LOG
20	2017-09-11 ...	info	IKE	[ID] : Tunnel [Server] Phase 2 Local policy mismatch	IKE_LOG
31	2017-09-11 ...	info	IKE	Send:[HASH][SA][NONCE][ID][ID]	IKE_LOG
32	2017-09-11 ...	info	IKE	Phase 1 IKE SA process done	IKE_LOG

## How to Configure GRE over IPsec VPN Tunnel

This example shows how to use the VPN Setup Wizard to create a GRE over IPsec VPN tunnel between ZyWALL/USG devices. The example instructs how to configure the VPN tunnel between each site. When the GRE over IPsec VPN tunnel is configured, each site can be accessed securely.

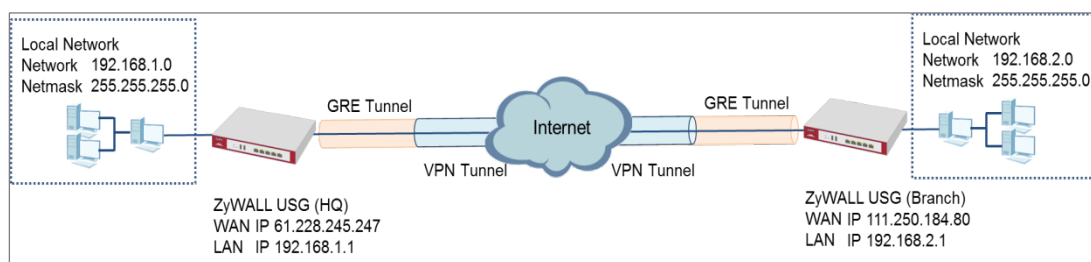

ZyWALL/USG GRE over IPsec VPN



### Note:

All network IP addresses and subnet masks are used as examples in this article. Please replace them with your actual network IP addresses and subnet masks. This example was tested using USG110 (Firmware Version: ZLD 4.25) and ZyWALL 310 (Firmware Version: ZLD 4.25).



## Set Up the ZyWALL/USG GRE over IPsec VPN Tunnel of Corporate Network (HQ)

In the ZyWALL/USG, go to **Quick Setup > VPN Setup Wizard**, use the **VPN Settings** wizard to create a VPN rule that can be used with the FortiGate. Click **Next**.

Quick Setup > VPN Setup Wizard > Welcome

VPN Setup Wizard

Wizard Type > VPN Settings > Wizard Completed

1 2 3

**Welcome**

- VPN Settings
  - Wizard Type
  - VPN Settings
  - Wizard Completed
- VPN Settings for Configuration Provisioning
  - Wizard Type
  - VPN Settings
  - Wizard Completed
- VPN Settings for L2TP VPN Settings
  - VPN Settings
  - General Settings
  - Wizard Completed

Choose **Express** to create a VPN rule with the default phase 1 and phase 2 settings and use a pre-shared key to be the authentication method. Click **Next**.

Quick Setup > VPN Setup Wizard > Wizard Type

VPN Setup Wizard

Wizard Type > VPN Settings > Wizard Completed

1 2 3

**Please select the type of VPN policy you wish to setup.**

Type of VPN policy

- Express
- Advanced

Type the **Rule Name** used to identify this VPN connection (and VPN gateway). You may use 1-31 alphanumeric characters. This value is case-sensitive. Select the rule to be **Site-to-site**. Click **Next**.

**Quick Setup > VPN Setup Wizard > Wizard Type > VPN Settings (Scenario)**

**VPN Setup Wizard**

Wizard Type > **VPN Settings** > Wizard Completed

**Express Settings**

**IKE Version**

- IKEv1
- IKEv2

**Scenario**

Rule Name:

- Site-to-site
- Site-to-site with Dynamic Peer
- Remote Access (Server Role)
- Remote Access (Client Role)

Configure **Secure Gateway** IP as the Branch's WAN IP address (in the example, 111.250.184.80). Then, type a secure **Pre-Shared Key** (8-32 characters).

Set **Local Policy** to be the IP address range of the network connected to the ZyWALL/USG (HQ) and **Remote Policy** to be the IP address range of the network connected to the ZyWALL/USG (Branch).

**Quick Setup > VPN Setup Wizard > Wizard Type > VPN Settings (Configuration)**

**VPN Setup Wizard**

Wizard Type > **VPN Settings** > Wizard Completed

**Express Settings**

**Configuration**

Secure Gateway:  (IP or FQDN)

Pre-Shared Key:

Local Policy (IP/Mask):

Remote Policy (IP/Mask):

This screen provides a read-only summary of the VPN tunnel. Click **Save**.

**Quick Setup > VPN Setup Wizard > Welcome > Wizard Type > VPN Settings  
(Summary)**

**VPN Setup Wizard**

Wizard Type > 1
VPN Settings > 2
Wizard Completed > 3

**Express Settings**

**Summary**

Rule Name:	WIZ_VPN_HQ
Secure Gateway:	111.250.184.80
Pre-Shared Key:	12345678
Local Policy (IP/Mask):	192.168.1.0 / 255.255.255.0
Remote Policy (IP/Mask):	192.168.2.0 / 255.255.255.0

Now the rule is configured on the ZyWALL/USG. The Phase 1 rule settings appear in the **VPN > IPSec VPN > VPN Gateway** screen and the Phase 2 rule settings appear in the **VPN > IPSec VPN > VPN Connection** screen. Click **Close** to exit the wizard.

**Quick Setup > VPN Setup Wizard > Welcome > Wizard Type > VPN Settings > Wizard Completed**

**VPN Setup Wizard**

Wizard Type > 1
VPN Settings > 2
Wizard Completed > 3

**Express Settings**

Congratulations. The VPN Access wizard is completed

**Summary**

Rule Name:	WIZ_VPN_HQ
Secure Gateway:	111.250.184.80
Pre-Shared Key:	12345678
Local Policy (IP/Mask):	192.168.1.0 / 255.255.255.0
Remote Policy (IP/Mask):	192.168.2.0 / 255.255.255.0

Go to **CONFIGURATION > VPN > IPsec VPN > VPN Gateway > Show Advanced Settings**. Configure **Authentication > Peer ID Type** as **Any** to let the ZyWALL/USG does not require to check the identity content of the remote IPsec router.

**CONFIGURATION > VPN > IPsec VPN > VPN Gateway > Show Advanced Settings > Authentication > Peer ID Type**

The screenshot shows the 'Authentication' configuration page. Under the 'Peer ID Type' section, the 'Local ID Type' is set to 'IPv4', 'Content' is '0.0.0.0', and 'Peer ID Type' is set to 'Any' (highlighted with a red box). The 'Advance' section is expanded, showing these settings. Other options include 'Pre-Shared Key' (selected), 'Certificate', and 'User Based PSK'.

Go to **CONFIGURATION > VPN > IPsec VPN > VPN Connection > Show Advanced Settings > Policy**. Select **Enable GRE over IPsec**.

**CONFIGURATION > VPN > IPsec VPN > VPN Connection > Show Advanced Settings > Policy**

The screenshot shows the 'Policy' configuration page. Under the 'Advance' section, the 'Enable GRE over IPsec' checkbox is checked (highlighted with a red box). Other settings include 'Local policy' (WIZ\_VPN\_HQ\_LOC) and 'Remote policy' (WIZ\_VPN\_HQ\_REM).

The GRE tunnel runs between the IPsec public interface on the HQ unit and the Branch unit. Go to **CONFIGURATION > Network > Interface > Tunnel > Add**. Enter the **Interface Name** (The format is *tunnelx*, where x is 0 - 3.). Enter the **IP Address** and **Subnet Mask** for this interface. Specify **My Address** to be the interface or IP address to use as the source address for the packets this interface tunnels to the remote gateway. Enter **Remote Gateway Address** to be the IP address or domain name of the remote gateway to this tunnel traffic.

CONFIGURATION > Network > Interface > Tunnel > Add

General Settings	
<input checked="" type="checkbox"/> Enable	
Interface Properties	
Interface Name:	<input type="text" value="tunnel1"/>
Zone:	<input type="text" value="TUNNEL"/> ⓘ
Tunnel Mode:	<input type="text" value="GRE"/>
IP Address Assignment	
IP Address:	<input type="text" value="10.0.0.1"/>
Subnet Mask:	<input type="text" value="255.255.255.0"/>
Metric:	<input type="text" value="0"/> (0-15)
Gateway Settings	
My Address	
<input checked="" type="radio"/> Interface	<input type="text" value="ge1"/> Static -- 61.226.245.247/255.255.255.255
<input type="radio"/> IP Address	<input type="text" value="0.0.0.0"/>
Remote Gateway Address:	<input type="text" value="111.250.184.80"/>

## Set Up the ZyWALL/USG GRE over IPsec VPN Tunnel of Corporate Network (Branch)

In the ZyWALL/USG, go to **Quick Setup > VPN Setup Wizard**, use the **VPN Settings** wizard to create a VPN rule that can be used with the FortiGate. Click **Next**.

### Quick Setup > VPN Setup Wizard > Welcome

**VPN Setup Wizard**

Wizard Type > VPN Settings > Wizard Completed  
1 2 3

**Welcome**

- VPN Settings
  - Wizard Type
  - VPN Settings
  - Wizard Completed
- VPN Settings for Configuration Provisioning
  - Wizard Type
  - VPN Settings
  - Wizard Completed
- VPN Settings for L2TP VPN Settings
  - VPN Settings
  - General Settings
  - Wizard Completed

Choose **Express** to create a VPN rule with the default phase 1 and phase 2 settings and use a pre-shared key to be the authentication method. Click **Next**.

### Quick Setup > VPN Setup Wizard > Wizard Type

**VPN Setup Wizard**

Wizard Type > VPN Settings > Wizard Completed  
1 2 3

Please select the type of VPN policy you wish to setup.

Type of VPN policy

- Express
- Advanced

Type the **Rule Name** used to identify this VPN connection (and VPN gateway). You may use 1-31 alphanumeric characters. This value is case-sensitive. Select the rule to be **Site-to-site**. Click **Next**.

**Quick Setup > VPN Setup Wizard > Wizard Type > VPN Settings (Scenario)**

VPN Setup Wizard

---

Wizard Type > **VPN Settings** > Wizard Completed

1
2
3

**Express Settings**

**IKE Version**

IKEv1

IKEv2

**Scenario**

Rule Name:

Site-to-site

Site-to-site with Dynamic Peer

Remote Access (Server Role)

Remote Access (Client Role)

Configure **Secure Gateway** IP as the HQ's WAN IP address (in the example, 61.228.245.247). Then, type a secure **Pre-Shared Key** (8-32 characters).

Set **Local Policy** to be the IP address range of the network connected to the ZyWALL/USG (Branch) and **Remote Policy** to be the IP address range of the network connected to the ZyWALL/USG (HQ).

**Quick Setup > VPN Setup Wizard > Wizard Type > VPN Settings (Configuration)**

VPN Setup Wizard

---

Wizard Type > **VPN Settings** > Wizard Completed

1
2
3

**Express Settings**

**Configuration**

Secure Gateway:  (IP or FQDN)

Pre-Shared Key:

Local Policy (IP/Mask):

Remote Policy (IP/Mask):

This screen provides a read-only summary of the VPN tunnel. Click **Save**.

**Quick Setup > VPN Setup Wizard > Welcome > Wizard Type > VPN Settings (Summary)**

**VPN Setup Wizard**

Wizard Type > **VPN Settings** > Wizard Completed

1                      2                      3

**Express Settings**

**Summary**

Rule Name:	WIZ_VPN_Branch
Secure Gateway:	61.228.245.247
Pre-Shared Key:	12345678
Local Policy (IP/Mask):	192.168.2.0 / 255.255.255.0
Remote Policy (IP/Mask):	192.168.1.0 / 255.255.255.0

Now the rule is configured on the ZyWALL/USG. The Phase 1 rule settings appear in the **VPN > IPSec VPN > VPN Gateway** screen and the Phase 2 rule settings appear in the **VPN > IPSec VPN > VPN Connection** screen. Click **Close** to exit the wizard.

**Quick Setup > VPN Setup Wizard > Welcome > Wizard Type > VPN Settings > Wizard Completed**

**VPN Setup Wizard**

Wizard Type > VPN Settings > **Wizard Completed**

1                      2                      3

**Express Settings**

Congratulations. The VPN Access wizard is completed

**Summary**

Rule Name:	WIZ_VPN_Branch
Secure Gateway:	61.228.245.247
Pre-Shared Key:	12345678
Local Policy (IP/Mask):	192.168.2.0 / 255.255.255.0
Remote Policy (IP/Mask):	192.168.1.0 / 255.255.255.0



Go to **CONFIGURATION > VPN > IPsec VPN > VPN Gateway > Show Advanced Settings**. Configure **Authentication > Peer ID Type** as **Any** to let the ZyWALL/USG does not require to check the identity content of the remote IPsec router.

**CONFIGURATION > VPN > IPsec VPN > VPN Gateway > Show Advanced Settings > Authentication > Peer ID Type**

The screenshot shows the 'Authentication' configuration page. Under the 'Peer ID Type' section, the 'Any' option is selected and highlighted with a red box. The 'Local ID Type' is set to 'IPv4' and the 'Content' is '0.0.0.0'. The 'Pre-Shared Key' is masked with dots, and the 'Certificate' and 'User Based PSK' options are not selected.

Go to **CONFIGURATION > VPN > IPsec VPN > VPN Connection > Show Advanced Settings > Policy**. Select **Enable GRE over IPsec**.

**CONFIGURATION > VPN > IPsec VPN > VPN Connection > Show Advanced Settings > Policy**

The screenshot shows the 'Policy' configuration page. Under the 'Advance' section, the 'Enable GRE over IPsec' checkbox is checked and highlighted with a red box. The 'Local policy' is 'WIZ\_VPN\_Branch\_L' and the 'Remote policy' is 'WIZ\_VPN\_Branch\_f'. The 'Policy Enforcement' checkbox is not checked.

The GRE tunnel runs between the IPsec public interface on the Branch unit and the HQ unit. Go to **CONFIGURATION > Network > Interface > Tunnel > Add**. Enter the **Interface Name** (The format is *tunnelx*, where x is 0 - 3.). Enter the **IP Address** and **Subnet Mask** for this interface. Specify **My Address** to be the interface or IP address to use as the source address for the packets this interface tunnels to the remote gateway. Enter **Remote Gateway Address** to be the IP address or domain name of the remote gateway to this tunnel traffic.

**CONFIGURATION > Network > Interface > Tunnel > Add**

**General Settings**

Enable

---

**Interface Properties**

Interface Name:

Zone: TUNNEL ▼ ⓘ

Tunnel Mode: GRE ▼

---

**IP Address Assignment**

IP Address:

Subnet Mask:

Metric:  (0-15)

---

**Gateway Settings**

My Address

Interface ge1 ▼ Static -- 111.250.184.80/255.255.255.255

IP Address 0.0.0.0

Remote Gateway Address:

## Test the GRE over IPSec VPN Tunnel

Go to ZyWALL/USG **CONFIGURATION > VPN > IPSec VPN > VPN Connection**, click **Connect** on the upper bar. The **Status** connect icon is lit when the interface is connected.

**CONFIGURATION > VPN > IPSec VPN > VPN Connection**

IPv4 Configuration						
#	Status	Name	VPN Gateway	Gateway IP Version	Policy	
1		WIZ_VPN_HQ	WIZ_VPN_HQ	IPv4	<a href="#">WIZ_VPN_HQ_LOCAL/A...</a>	

Page 1 of 1 | Show 50 items | Displaying 1 - 1 of 1

Go to ZyWALL/USG **MONITOR > VPN Monitor > IPSec** and verify the tunnel **Up Time** and **Inbound (Bytes)/Outbound (Bytes)** Traffic.

## MONITOR > VPN Monitor > IPSec

#	Name	Policy	My Address	Secure Gateway	Timeout	Inbound(Byte)	Outbound(Byte)
1	WIZ_VPN_HQ	192.168.1.0/24<>192.168.2.0/24	61.225.245.247	P: 111.250.184.80	86360	0(0 bytes)	0(0 bytes)

Page 1 of 1 | Show 50 items | Displaying 1 - 1 of 1

## What Could Go Wrong?

If you see below [info] or [error] log message, please check ZyWALL/USG Phase 1 Settings. Make sure your ZyWALL/USG Phase 1 Settings are supported in the Amazon VPC IKE Phase 1 setup list.

### MONITOR > Log

Priority	Category	Message	Note
info	IKE	Recv:[NOTIFY:INVALID_COOKIE]	IKE_LOG
info	IKE	Send:[ID][HASH][NOTIFY:INITIAL_CONTACT]	IKE_LOG
Priority	Category	Message	Note
error	IPSec	SPI: 0x0 (0) SEQ: 0x0 (0) No rule found, Dropping TCP packet	IPSec
error	IPSec	SPI: 0x0 (0) SEQ: 0x0 (0) No rule found, Dropping TCP packet	IPSec
info	IKE	[COOKIE] Invalid cookie, no sa found	IKE_LOG
Priority	Category	Message	Note
info	IKE	Recv:[HASH][NOTIFY:NO_PROPOSAL_CHOSEN]	IKE_LOG

If you see that Phase 1 IKE SA process done but still get below [info] log message, please check ZyWALL/USG Phase 2 Settings. Make sure your ZyWALL/USG Phase 2 Settings are supported in the Amazon VPC IKE Phase 2 setup list.

### MONITOR > Log

19	2017-09-11 ...	info	IKE	[SA] : No proposal chosen	IKE_LOG
20	2017-09-11 ...	info	IKE	[ID] : Tunnel [Server] Phase 2 Local policy mismatch	IKE_LOG
31	2017-09-11 ...	info	IKE	Send:[HASH][SA][NONCE][ID][ID]	IKE_LOG
32	2017-09-11 ...	info	IKE	Phase 1 IKE SA process done	IKE_LOG

**ZYXEL**

[www.zyxel.com](http://www.zyxel.com)

## How to Configure Site-to-site IPSec VPN Where the Peer has a Static IP Address

This example shows how to use the VPN Setup Wizard to create a site-to-site VPN with the Peer has a Static IP Address. The example instructs how to configure the VPN tunnel between each site. When the VPN tunnel is configured, each site can be accessed securely.

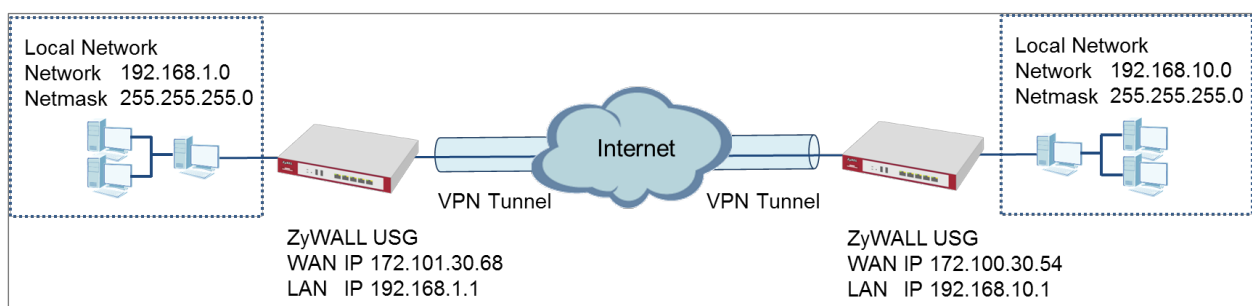

ZyWALL Site-to-site IPSec VPN with a Static IP Address Peer

 Note: All network IP addresses and subnet masks are used as examples in this article. Please replace them with your actual network IP addresses and subnet masks. This example was tested using USG310 (Firmware Version: ZLD 4.25).

Set Up the ZyWALL/USG IPSec VPN Tunnel of Corporate Network (HQ) In the ZyWALL/USG, go to **Quick Setup > VPN Setup Wizard**, use the **VPN Settings** wizard to create a VPN rule that can be used with the remote ZyWALL/USG. Click **Next**.

## Quick Setup > VPN Setup Wizard > Welcome

### VPN Setup Wizard

Wizard Type > VPN Settings > Wizard Completed  
1 2 3

#### Welcome

- VPN Settings
  - Wizard Type
  - VPN Settings
  - Wizard Completed
- VPN Settings for Configuration Provisioning
  - Wizard Type
  - VPN Settings
  - Wizard Completed
- VPN Settings for L2TP VPN Settings
  - VPN Settings
  - General Settings
  - Wizard Completed

Choose **Express** to create a VPN rule with the default phase 1 and phase 2 settings and use a pre-shared key to be the authentication method. Click **Next**.

## Quick Setup > VPN Setup Wizard > Wizard Type

### VPN Setup Wizard

Wizard Type > VPN Settings > Wizard Completed  
1 2 3

Please select the type of VPN policy you wish to setup.

Type of VPN policy

- Express
- Advanced

Type the **Rule Name** used to identify this VPN connection (and VPN gateway).  
You may use 1-31 alphanumeric characters. This value is case-sensitive. Select the rule to be **Site-to-site**. Click **Next**.

## Quick Setup > VPN Setup Wizard > Wizard Type > VPN Settings (Scenario)

### VPN Setup Wizard

Wizard Type > **VPN Settings** > Wizard Completed

1      2      3

#### Express Settings

**IKE Version**

IKEv1  
 IKEv2

**Scenario**

Rule Name:

Site-to-site  
 Site-to-site with Dynamic Peer  
 Remote Access (Server Role)  
 Remote Access (Client Role)

Configure **Secure Gateway** IP as the peer ZyWALL/USG's WAN IP address (in the example, 172.100.30.54). Type a secure **Pre-Shared Key** (8-32 characters).

Set **Local Policy** to be the IP address range of the network connected to the ZyWALL/USG and **Remote Policy** to be the IP address range of the network connected to the peer ZyWALL/USG.

### Quick Setup > VPN Setup Wizard > Wizard Type > VPN Settings (Configuration)

**VPN Setup Wizard**

Wizard Type > **VPN Settings** > Wizard Completed

1      2      3

**Express Settings**

**Configuration**

Secure Gateway:	172.100.30.54	(IP or FQDN)
Pre-Shared Key:	12345678	
Local Policy (IP/Mask):	192.168.1.0	/255.255.255.0
Remote Policy (IP/Mask):	192.168.10.0	/255.255.255.0

This screen provides a read-only summary of the VPN tunnel. Click **Save**.

### Quick Setup > VPN Setup Wizard > Welcome > Wizard Type > VPN Settings (Summary)

**VPN Setup Wizard**

Wizard Type > **VPN Settings** > Wizard Completed

1      2      3

**Express Settings**

**Summary**

Rule Name:	WIZ_VPN_HQ
Secure Gateway:	172.100.30.54
Pre-Shared Key:	12345678
Local Policy (IP/Mask):	192.168.1.0 / 255.255.255.0
Remote Policy (IP/Mask):	192.168.10.0 / 255.255.255.0



Now the rule is configured on the ZyWALL/USG. The Phase 1 rule settings appear in the **VPN > IPSec VPN > VPN Gateway** screen and the Phase 2 rule settings appear in the **VPN > IPSec VPN > VPN Connection** screen. Click **Close** to exit the wizard.

**Quick Setup > VPN Setup Wizard > Welcome > Wizard Type > VPN Settings > Wizard Completed**

**VPN Setup Wizard**

Wizard Type > VPN Settings > Wizard Completed

**Express Settings**

Congratulations. The VPN Access wizard is completed

Summary

Rule Name:	WIZ_VPN_HQ
Secure Gateway:	172.100.30.54
Pre-Shared Key:	12345678
Local Policy (IP/Mask):	192.168.1.0 / 255.255.255.0
Remote Policy (IP/Mask):	192.168.10.0 / 255.255.255.0

Go to **CONFIGURATION > VPN > IPSec VPN > VPN Gateway** and click **Show Advanced Settings**. Configure **Authentication > Peer ID Type** as **Any** to let the ZyWALL/USG does not require to check the identity content of the remote IPSec router.

**CONFIGURATION > VPN > IPSec VPN > VPN Gateway > Show Advanced Settings > Authentication > Peer ID Type**

**Authentication**

Pre-Shared Key   unmasked

Certificate  (See [My Certificates](#))

User Based PSK  ⓘ

**Advance**

Local ID Type:

Content:

Peer ID Type:

Content:

## Set Up the ZyWALL/USG IPSec VPN Tunnel of Corporate Network

### (Branch)

In the ZyWALL/USG, go to **Quick Setup > VPN Setup Wizard**, use the **VPN Settings** wizard to create a VPN rule that can be used with the remote ZyWALL/USG. Click **Next**.

#### Quick Setup > VPN Setup Wizard > Welcome

**VPN Setup Wizard**

Wizard Type > VPN Settings > Wizard Completed  
1 2 3

**Welcome**

- VPN Settings
  - Wizard Type
  - VPN Settings
  - Wizard Completed
- VPN Settings for Configuration Provisioning
  - Wizard Type
  - VPN Settings
  - Wizard Completed
- VPN Settings for L2TP VPN Settings
  - VPN Settings
  - General Settings
  - Wizard Completed

Choose **Express** to create a VPN rule with the default phase 1 and phase 2 settings and to use a pre-shared key. Click **Next**.

## Quick Setup > VPN Setup Wizard > Wizard Type

VPN Setup Wizard

Wizard Type > VPN Settings > Wizard Completed

1 2 3

Please select the type of VPN policy you wish to setup.

Type of VPN policy

Express

Advanced

Type the **Rule Name** used to identify this VPN connection (and VPN gateway). You may use 1-31 alphanumeric characters. This value is case-sensitive. Click **Next**.

## Quick Setup > VPN Setup Wizard > Wizard Type > VPN Settings (Scenario)

VPN Setup Wizard

Wizard Type > VPN Settings > Wizard Completed

1 2 3

Express Settings

IKE Version

IKEv1

IKEv2

Scenario

Rule Name:

Site-to-site

Site-to-site with Dynamic Peer

Remote Access (Server Role)

Remote Access (Client Role)

Configure **Secure Gateway** IP as the peer ZyWALL/USG's WAN IP address (in the example, 172.101.30.68). Type a secure **Pre-Shared Key** (8-32 characters).

Set **Local Policy** to be the IP address range of the network connected to the ZyWALL/USG and **Remote Policy** to be the IP address range of the network connected to the peer ZYWALL/USG.

**Quick Setup > VPN Setup Wizard > Wizard Type > VPN Settings (Configuration)**

**VPN Setup Wizard**

Wizard Type > **VPN Settings** > Wizard Completed  
1 2 3

**Express Settings**

**Configuration**

Secure Gateway:	172.101.30.68	(IP or FQDN)
Pre-Shared Key:	12345678	
Local Policy (IP/Mask):	192.168.1.0	/ 255.255.255.0
Remote Policy (IP/Mask):	192.168.10.0	/ 255.255.255.0

This screen provides a read-only summary of the VPN tunnel. Click **Save**.

**Quick Setup > VPN Setup Wizard > Welcome > Wizard Type > VPN Settings (Summary)**

**VPN Setup Wizard**

Wizard Type > **VPN Settings** > Wizard Completed  
1 2 3

**Express Settings**

**Summary**

Rule Name:	WIZ_VPN_Branch
Secure Gateway:	172.101.30.68
Pre-Shared Key:	12345678
Local Policy (IP/Mask):	192.168.1.0 / 255.255.255.0
Remote Policy (IP/Mask):	192.168.10.0 / 255.255.255.0

Now the rule is configured on the ZyWALL/USG. The Phase 1 rule settings appear in the **VPN > IPSec VPN > VPN Gateway** screen and the Phase 2 rule settings appear in the **VPN > IPSec VPN > VPN Connection** screen. Click **Close** to exit the wizard.

**Quick Setup > VPN Setup Wizard > Welcome > Wizard Type > VPN Settings > Wizard Completed**

**VPN Setup Wizard**

Wizard Type > VPN Settings > Wizard Completed

1 2 3

**Express Settings**

Congratulations. The VPN Access wizard is completed

Summary

Rule Name:	WIZ_VPN_Branch
Secure Gateway:	172.101.30.68
Pre-Shared Key:	12345678
Local Policy (IP/Mask):	192.168.1.0 / 255.255.255.0
Remote Policy (IP/Mask):	192.168.10.0 / 255.255.255.0

Go to **CONFIGURATION > VPN > IPSec VPN > VPN Gateway** and click **Show Advanced Settings**. **Configure Authentication > Peer ID Type** as **Any** to let the ZyWALL/USG does not require to check the identity content of the remote IPSec router.

**CONFIGURATION > VPN > IPSec VPN > VPN Gateway > Show Advanced Settings > Authentication > Peer ID Type**

**Authentication**

Pre-Shared Key   unmasked

Certificate  (See [My Certificates](#))

User Based PSK  ⓘ

⊟ Advance

Local ID Type:

Content:

Peer ID Type:

Content:

## Test the IPsec VPN Tunnel

Go to ZYWALL/USG **CONFIGURATION > VPN > IPsec VPN > VPN Connection**, click **Connect** on the upper bar. The **Status** connect icon is lit when the interface is connected.

### CONFIGURATION > VPN > IPsec VPN > VPN Connection

#	Status	Name	VPN Gateway	Gateway IP Version	Policy
1		VPN_to_Azure	VPN_to_Azure	IPv4	WIZ_VPN_HQ_LOCAL/WIZ_VPN_HQ_REMOTE

Go to ZyWALL/USG **MONITOR > VPN Monitor > IPsec** and verify the tunnel **Up Time** and **Inbound(Bytes)/Outbound(Bytes)** Traffic.

### MONITOR > VPN Monitor > IPsec

#	Name	Policy	My Address	Secure Gateway	Up Time	Timeout	Inbound...	Outbound...
1	Hub_HQ-to-Branch_A	192.168.1.0/24<>192.168.10.0/24	172.101.30.68	P: 172.100.30.54	101	86319	0(0 bytes)	0(0 bytes)

To test whether or not a tunnel is working, ping from a computer at one site to a computer at the other. Ensure that both computers have Internet access (via the IPsec devices).

### PC at HQ Office > Window 7 > cmd > ping 192.168.10.33

```
C:\Documents and Settings\ZYXEL>ping 192.168.10.33

Pinging 192.168.10.33 with 32 bytes of data:

Reply from 192.168.10.33: bytes=32 time=18ms TTL=54
Reply from 192.168.10.33: bytes=32 time=17ms TTL=54
Reply from 192.168.10.33: bytes=32 time=17ms TTL=54
Reply from 192.168.10.33: bytes=32 time=16ms TTL=54

Ping statistics for 192.168.10.33:
    Packets: Sent = 4, Received = 4, Lost = 0 (0% loss),
    Approximate round trip times in milli-seconds:
        Minimum = 16ms, Maximum = 18ms, Average = 17ms
```

PC at Branch Office > Window 7 > cmd > ping 192.168.1.33

```
C:\Documents and Settings\ZyXEL>ping 192.168.1.33

Pinging 192.168.1.33 with 32 bytes of data:

Reply from 192.168.1.33: bytes=32 time=27ms TTL=43
Reply from 192.168.1.33: bytes=32 time=32ms TTL=43
Reply from 192.168.1.33: bytes=32 time=26ms TTL=43
Reply from 192.168.1.33: bytes=32 time=27ms TTL=43

Ping statistics for 192.168.1.33:
    Packets: Sent = 4, Received = 4, Lost = 0 (0% loss),
    Approximate round trip times in milli-seconds:
        Minimum = 26ms, Maximum = 32ms, Average = 28ms
```

## What Could Go Wrong?

If you see below [info] or [error] log message, please check ZyWALL/USG Phase 1 Settings. Both ZyWALL/USG at the HQ and Branch sites must use the same Pre-Shared Key, Encryption, Authentication method, DH key group and ID Type to establish the IKE SA.

### MONITOR > Log

Priority	Category	Message	Note
info	IKE	Recv:[NOTIFY:INVALID_COOKIE]	IKE_LOG
info	IKE	Send:[ID][HASH][NOTIFY:INITIAL_CONTACT]	IKE_LOG
Priority	Category	Message	Note
error	IPSec	SPI: 0x0 (0) SEQ: 0x0 (0) No rule found, Dropping TCP packet	IPSec
error	IPSec	SPI: 0x0 (0) SEQ: 0x0 (0) No rule found, Dropping TCP packet	IPSec
info	IKE	[COOKIE] Invalid cookie, no sa found	IKE_LOG
Priority	Category	Message	Note
info	IKE	Recv:[HASH][NOTIFY:NO_PROPOSAL_CHOSEN]	IKE_LOG

If you see that Phase 1 IKE SA process done but still get below [info] log message, please check ZyWALL/USG Phase 2 Settings. Both ZyWALL/USG at the HQ and Branch sites must use the same Protocol, Encapsulation, Encryption, Authentication method and PFS to establish the IKE SA.

## MONITOR > Log

19	2017-09-11 ...	info	IKE	[SA] : No proposal chosen	IKE_LOG
20	2017-09-11 ...	info	IKE	[ID] : Tunnel [Server] Phase 2 Local policy mismatch	IKE_LOG
31	2017-09-11 ...	info	IKE	Send:[HASH][SA][NONCE][ID][ID]	IKE_LOG
32	2017-09-11 ...	info	IKE	Phase 1 IKE SA process done	IKE_LOG

Make sure the both ZyWALL/USG at the HQ and Branch sites security policies allow IPSec VPN traffic. IKE uses UDP port 500, AH uses IP protocol 51, and ESP uses IP protocol 50.

Default NAT traversal is enable on ZyWALL/USG, please make sure the remote IPSec device must also have NAT traversal enabled.



## How to Configure Site-to-site IPsec VPN Where the Peer has a Dynamic IP Address

This example shows how to use the VPN Setup Wizard to create a site-to-site VPN with the Peer has a Dynamic IP Address. The example instructs how to configure the VPN tunnel between each site. When the VPN tunnel is configured, each site can be accessed securely.

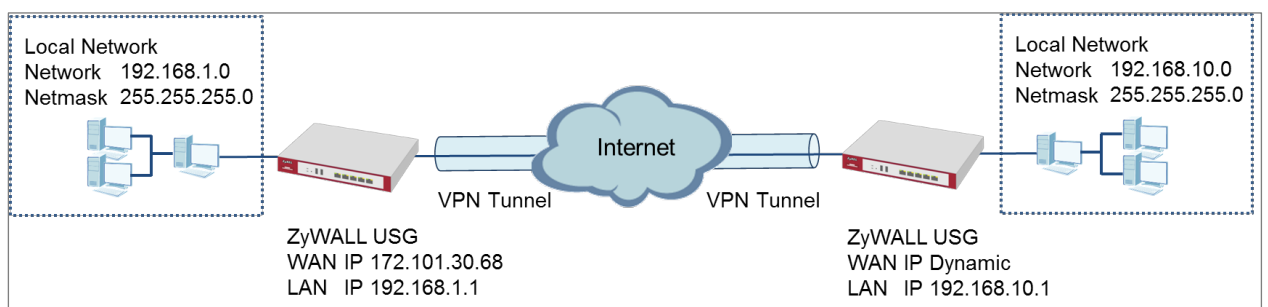

ZyWALL Site-to-site IPsec VPN with a Dynamic IP Address Peer

 Note: All network IP addresses and subnet masks are used as examples in this article. Please replace them with your actual network IP addresses and subnet masks. This example was tested using USG310 (Firmware Version: ZLD 4.25).

## Set Up the ZyWALL/USG IPsec VPN Tunnel of Corporate Network

## (HQ)

In the ZyWALL/USG, go to **Quick Setup > VPN Setup Wizard**, use the **VPN Settings** wizard to create a VPN rule that can be used with the remote ZyWALL/USG. Click **Next**.

### Quick Setup > VPN Setup Wizard > Welcome

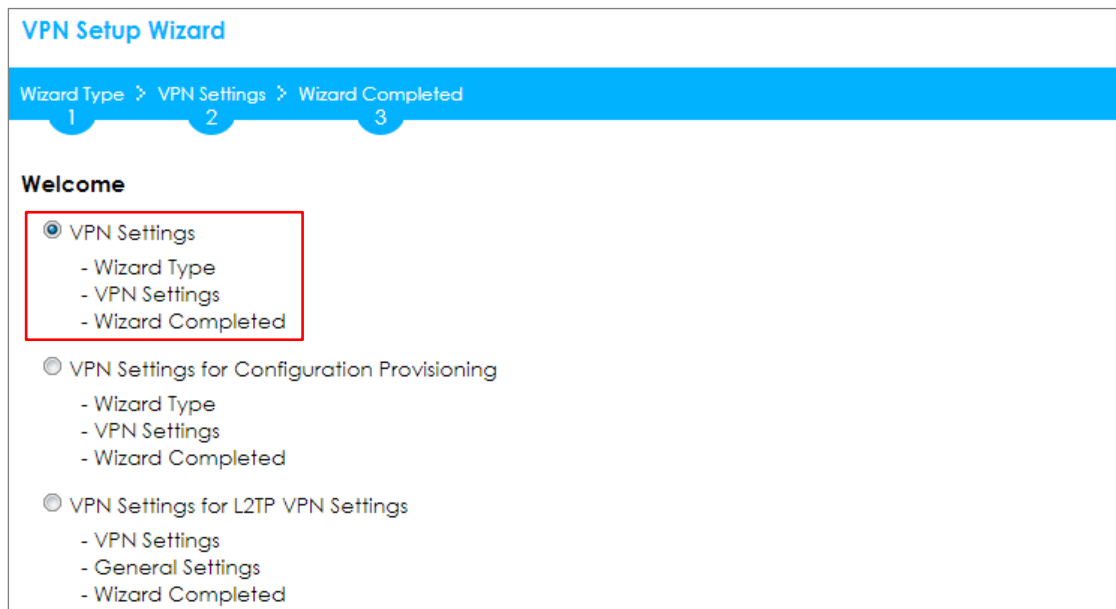

Choose **Express** to create a VPN rule with the default phase 1 and phase 2 settings and use a pre-shared key to be the authentication method. Click **Next**.

### Quick Setup > VPN Setup Wizard > Wizard Type

**VPN Setup Wizard**

Wizard Type > VPN Settings > Wizard Completed

1 2 3

Please select the type of VPN policy you wish to setup.

Type of VPN policy

Express

Advanced

Type the **Rule Name** used to identify this VPN connection (and VPN gateway). You may use 1-31 alphanumeric characters. This value is case-sensitive. Select the rule to be **Site-to-site with Dynamic Peer**. Click **Next**.

**Quick Setup > VPN Setup Wizard > Wizard Type > VPN Settings (Scenario)**

**VPN Setup Wizard**

Wizard Type > **VPN Settings** > Wizard Completed

1 2 3

**Express Settings**

**IKE Version**

IKEv1

IKEv2

**Scenario**

Rule Name:

Site-to-site

Site-to-site with Dynamic Peer

Remote Access (Server Role)

Remote Access (Client Role)

Type a secure **Pre-Shared Key** (8-32 characters). Then, set **Local Policy** to be the IP address range of the network connected to the ZyWALL/USG and **Remote Policy** to be the IP address range of the network connected to the peer ZYWALL/USG.

**Quick Setup > VPN Setup Wizard > Wizard Type > VPN Settings (Configuration)**

**VPN Setup Wizard**

Wizard Type > 1
VPN Settings > 2
Wizard Completed > 3

**Express Settings**

**Configuration**

Secure Gateway: Any

Pre-Shared Key:

Local Policy (IP/Mask):  /

Remote Policy (IP/Mask):  /

This screen provides a read-only summary of the VPN tunnel. Click **Save**.

**Quick Setup > VPN Setup Wizard > Wizard Type > VPN Settings (Summary)**

**VPN Setup Wizard**

Wizard Type > 1
VPN Settings > 2
Wizard Completed > 3

**Express Settings**

**Summary**

Rule Name: WIZ\_VPN\_HQ

Secure Gateway: Any

Pre-Shared Key: 12345678

Local Policy (IP/Mask): 192.168.1.0 / 255.255.255.0

Remote Policy (IP/Mask): 192.168.10.0 / 255.255.255.0

Now the rule is configured on the ZyWALL/USG. The Phase 1 rule settings appear in the **VPN > IPSec VPN > VPN Gateway** screen and the Phase 2 rule settings appear in the **VPN > IPSec VPN > VPN Connection** screen. Click **Close** to exit the wizard.

**Quick Setup > VPN Setup Wizard > Wizard Type > VPN Settings > Wizard completed**

**VPN Setup Wizard**

[Wizard Type](#) > [VPN Settings](#) > **Wizard Completed**

1
2
3

**Express Settings**

Congratulations. The VPN Access wizard is completed

Summary

Rule Name:	WIZ_VPN_HQ
Secure Gateway:	Any
Pre-Shared Key:	12345678
Local Policy (IP/Mask):	192.168.1.0 / 255.255.255.0
Remote Policy (IP/Mask):	192.168.10.0 / 255.255.255.0

Go to **CONFIGURATION > VPN > IPSec VPN > VPN Gateway** and click **Show Advanced Settings**. Configure **Authentication > Peer ID Type** as **Any** to let the ZyWALL/USG does not require to check the identity content of the remote IPSec router.

**CONFIGURATION > VPN > IPSec VPN > VPN Gateway > Show Advanced Settings > Authentication > Peer ID Type**

**Authentication**

Pre-Shared Key .....

unmasked

Certificate default (See [My Certificates](#))

User Based PSK admin i

**Advance**

Local ID Type: IPv4

Content: 0.0.0.0

Peer ID Type: Any

Content:

## Set Up the ZyWALL/USG IPSec VPN Tunnel of Corporate Network

## (Branch has a Dynamic IP Address)

In the ZyWALL/USG, go to **Quick Setup > VPN Setup Wizard**, use the **VPN Settings** to create a **Site-to-site VPN** Rule Name.

**Quick Setup > VPN Setup Wizard > Welcome**  
**Quick Setup > VPN Setup Wizard > Welcome**

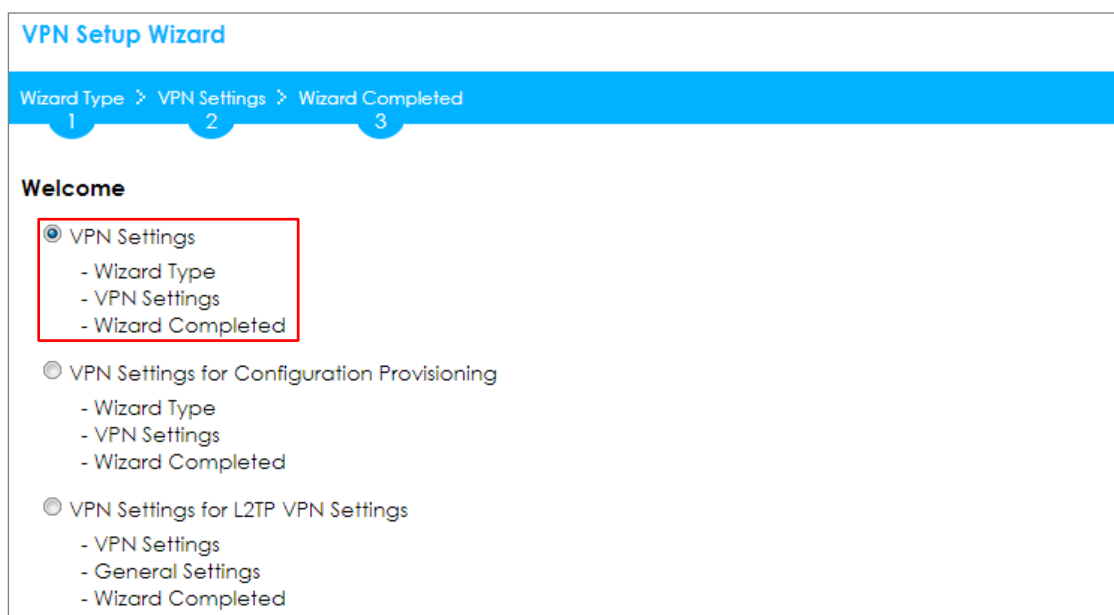

Choose **Express** to create a VPN rule with the default phase 1 and phase 2 settings and to use a pre-shared key. Click **Next**.

**Quick Setup > VPN Setup Wizard > Wizard Type**

**VPN Setup Wizard**

Wizard Type > 1
VPN Settings > 2
Wizard Completed > 3

**Please select the type of VPN policy you wish to setup.**

**Type of VPN policy**

Express

Advanced

Type the **Rule Name** used to identify this VPN connection (and VPN gateway). You may use 1-31 alphanumeric characters. This value is case-sensitive. Click **Next**.

**Quick Setup > VPN Setup Wizard > Wizard Type > VPN Settings (Scenario)**

**VPN Setup Wizard**

Wizard Type > 1
VPN Settings > 2
Wizard Completed > 3

**Express Settings**

**IKE Version**

IKEv1

IKEv2

**Scenario**

Rule Name:

Site-to-site

Site-to-site with Dynamic Peer

Remote Access (Server Role)

Remote Access (Client Role)

Configure **Secure Gateway** IP as the peer ZyWALL/USG's WAN IP address (in the example, 172.101.30.68). Type a secure **Pre-Shared Key** (8-32 characters).

Set **Local Policy** to be the ZyWALL/USG local IP address that can use the VPN tunnel and set **Remote Policy** to the peer ZyWALL/USG local IP address that can use the VPN tunnel. Click **OK**.

**Quick Setup > VPN Setup Wizard > Wizard Type > VPN Settings (Configuration)**

**VPN Setup Wizard**

Wizard Type > **VPN Settings** > Wizard Completed

1 2 3

**Express Settings**

**Configuration**

Secure Gateway:  (IP or FQDN)

Pre-Shared Key:

Local Policy (IP/Mask):  /

Remote Policy (IP/Mask):  /

This screen provides a read-only summary of the VPN tunnel. Click **Save**.

**Quick Setup > VPN Setup Wizard > Welcome > Wizard Type > VPN Settings (Summary)**

**VPN Setup Wizard**

Wizard Type > **VPN Settings** > Wizard Completed

1 2 3

**Express Settings**

**Summary**

Rule Name: WIZ\_VPN\_Branch\_Dynamic

Secure Gateway: 172.101.30.68

Pre-Shared Key: 12345678

Local Policy (IP/Mask): 192.168.10.0 / 255.255.255.0

Remote Policy (IP/Mask): 192.168.1.0 / 255.255.255.0

Now the rule is configured on the ZyWALL/USG. The Phase 1 rule settings appear in the **VPN > IPSec VPN > VPN Gateway** screen and the Phase 2 rule settings appear in the **VPN > IPSec VPN > VPN Connection** screen. Click **Close** to exit the wizard.

**Quick Setup > VPN Setup Wizard > Welcome > Wizard Type > VPN Settings > Wizard Completed**



**VPN Setup Wizard**

[Wizard Type](#) > [VPN Settings](#) > **Wizard Completed**

1
2
3

**Express Settings**

Congratulations. The VPN Access wizard is completed

Summary

Rule Name:	WIZ_VPN_Branch_Dynamic
Secure Gateway:	172.101.30.68
Pre-Shared Key:	12345678
Local Policy (IP/Mask):	0.0.0.0 / 255.255.255.0
Remote Policy (IP/Mask):	Any

Go to **CONFIGURATION > VPN > IPSec VPN > VPN Gateway** and click **Show Advanced Settings**. Configure **Authentication > Peer ID Type** as **Any** to let the ZyWALL/USG does not require to check the identity content of the remote IPSec router.

**CONFIGURATION > VPN > IPSec VPN > VPN Gateway > Show Advanced Settings > Authentication > Peer ID Type**

**Authentication**

Pre-Shared Key .....

unmasked

Certificate default (See [My Certificates](#))

User Based PSK admin i

Advance

Local ID Type: IPv4

Content: 0.0.0.0

Peer ID Type: Any

Content:

## Test the IPSec VPN Tunnel

The Site-to-site VPN with Dynamic Peer can only initiate the VPN tunnel from the peer has a dynamic IP Address. Go to **CONFIGURATION > VPN > IPSec VPN > VPN**

**Connection**, click **Connect** on the upper bar. The **Status** connect icon is lit when the interface is connected.

## CONFIGURATION > VPN > IPsec VPN > VPN Connection

#	Status	Name	VPN Gateway	Gateway IP	Version	Policy
1		WIZ_VPN_Bra...	WIZ_VPN_Branc...	IPV4		WIZ_VPN_Branch_Dynamic_LOCAL/WIZ_VPN_Branch_Dyna...

Page 1 of 1 | Show 50 items | Displaying 1 - 1 of 1

Go to **MONITOR > VPN Monitor > IPsec** and verify the tunnel **Up Time** and **Inbound(Bytes)/Outbound(Bytes)** Traffic.

## MONITOR > VPN Monitor > IPsec

#	Name	Policy	My Address	Secure Gateway	Up Time	Timeout	Inbound(By...	Outbound(...
1	WIZ_VPN_Branch_Dynamic	192.168.1.0/24<>...	172.101.30.68	D: 172.100.30.54	18	86402	0(0 bytes)	0(0 bytes)

Page 1 of 1 | Show 50 items | Displaying 1 - 1 of 1

To test whether or not a tunnel is working, ping from a computer at one site to a computer at the other. Ensure that both computers have Internet access (via the IPsec devices).

### PC at HQ Office > Window 7 > cmd > ping 192.168.10.33

```
C:\Documents and Settings\ZyXEL>ping 192.168.1.33

Pinging 192.168.1.33 with 32 bytes of data:

Reply from 192.168.1.33: bytes=32 time=27ms TTL=43
Reply from 192.168.1.33: bytes=32 time=32ms TTL=43
Reply from 192.168.1.33: bytes=32 time=26ms TTL=43
Reply from 192.168.1.33: bytes=32 time=27ms TTL=43

Ping statistics for 192.168.1.33:
    Packets: Sent = 4, Received = 4, Lost = 0 (0% loss),
    Approximate round trip times in milli-seconds:
        Minimum = 26ms, Maximum = 32ms, Average = 28ms
```

### PC at Branch Office > Window 7 > cmd > ping 192.168.1.33

```
C:\Documents and Settings\ZyXEL>ping 192.168.10.33

Pinging 192.168.10.33 with 32 bytes of data:

Reply from 192.168.10.33: bytes=32 time=18ms TTL=54
Reply from 192.168.10.33: bytes=32 time=17ms TTL=54
Reply from 192.168.10.33: bytes=32 time=17ms TTL=54
Reply from 192.168.10.33: bytes=32 time=16ms TTL=54

Ping statistics for 192.168.10.33:
    Packets: Sent = 4, Received = 4, Lost = 0 (0% loss),
    Approximate round trip times in milli-seconds:
        Minimum = 16ms, Maximum = 18ms, Average = 17ms
```

## What Could Go Wrong?

If you see below [info] or [error] log message, please check ZyWALL/USG Phase 1 Settings. Both ZyWALL/USG at the HQ and Branch sites must use the same Pre-Shared Key, Encryption, Authentication method, DH key group and ID Type to establish the IKE SA.

### MONITOR > Log

Priority	Category	Message	Note
info	IKE	Recv:[NOTIFY:INVALID_COOKIE]	IKE_LOG
info	IKE	Send:[ID][HASH][NOTIFY:INITIAL_CONTACT]	IKE_LOG
Priority	Category	Message	Note
error	IPSec	SPI: 0x0 (0) SEQ: 0x0 (0) No rule found, Dropping TCP packet	IPSec
error	IPSec	SPI: 0x0 (0) SEQ: 0x0 (0) No rule found, Dropping TCP packet	IPSec
info	IKE	[COOKIE] Invalid cookie, no sa found	IKE_LOG
Priority	Category	Message	Note
info	IKE	Recv:[HASH][NOTIFY:NO_PROPOSAL_CHOSEN]	IKE_LOG

If you see that Phase 1 IKE SA process done but still get below [info] log message, please check ZyWALL/USG Phase 2 Settings. Both ZyWALL/USG at the HQ and Branch sites must use the same Protocol, Encapsulation, Encryption, Authentication method and PFS to establish the IKE SA.

## MONITOR > Log

19	2017-09-11 ...	info	IKE	[SA] : No proposal chosen	IKE_LOG
20	2017-09-11 ...	info	IKE	[ID] : Tunnel [Server] Phase 2 Local policy mismatch	IKE_LOG
31	2017-09-11 ...	info	IKE	Send:[HASH][SA][NONCE][ID][ID]	IKE_LOG
32	2017-09-11 ...	info	IKE	Phase 1 IKE SA process done	IKE_LOG

Make sure the both ZyWALL/USG at the HQ and Branch sites security policies allow IPSec VPN traffic. IKE uses UDP port 500, AH uses IP protocol 51, and ESP uses IP protocol 50.

Default NAT traversal is enable on ZyWALL/USG, please make sure the remote IPSec device must also have NAT traversal enabled.

## How to Configure IPSec Site to Site VPN while one Site is behind a NAT router

This example shows how to use the VPN Setup Wizard to create a IPSec Site to Site VPN tunnel between ZyWALL/USG devices. The example instructs how to configure the VPN tunnel between each site while one Site is behind a NAT router. When the IPSec Site to Site VPN tunnel is configured, each site can be accessed securely.

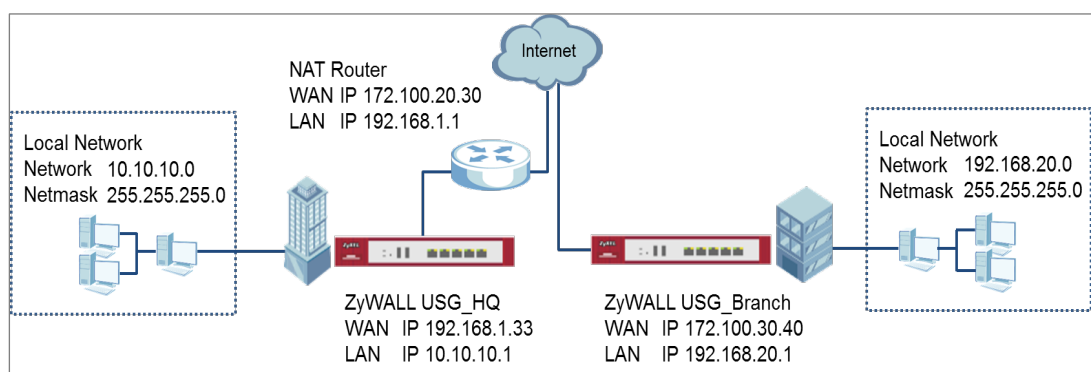

ZyWALL/USG Site to Site VPN while one Site is behind a NAT router

 **Note:**

All network IP addresses and subnet masks are used as examples in this article. Please replace them with your actual network IP addresses and subnet masks. This example was tested using USG110 (Firmware Version: ZLD 4.25) and ZyWALL 310 (Firmware Version: ZLD 4.25).

## Set Up the ZyWALL/USG IPSec VPN Tunnel of Corporate

## Network (HQ)

In the ZyWALL/USG, go to **Quick Setup > VPN Setup Wizard**, use the **VPN Settings** wizard to create a VPN rule that can be used with the FortiGate. Click **Next**.

### Quick Setup > VPN Setup Wizard > Welcome

**VPN Setup Wizard**

Wizard Type > VPN Settings > Wizard Completed  
1 2 3

**Welcome**

- VPN Settings
  - Wizard Type
  - VPN Settings
  - Wizard Completed
- VPN Settings for Configuration Provisioning
  - Wizard Type
  - VPN Settings
  - Wizard Completed
- VPN Settings for L2TP VPN Settings
  - VPN Settings
  - General Settings
  - Wizard Completed

Choose **Express** to create a VPN rule with the default phase 1 and phase 2 settings and use a pre-shared key to be the authentication method. Click **Next**.

### Quick Setup > VPN Setup Wizard > Wizard Type

**VPN Setup Wizard**

Wizard Type > VPN Settings > Wizard Completed  
1 2 3

**Please select the type of VPN policy you wish to setup.**

**Type of VPN policy**

- Express
- Advanced

Type the **Rule Name** used to identify this VPN connection (and VPN gateway). You may use 1-31 alphanumeric characters. This value is case-sensitive. Select the rule to be **Site-to-site**. Click **Next**.

**Quick Setup > VPN Setup Wizard > Wizard Type > VPN Settings (Scenario)**

VPN Setup Wizard

---

Wizard Type > **VPN Settings** > Wizard Completed

1
2
3

**Express Settings**

**IKE Version**

IKEv1

IKEv2

**Scenario**

Rule Name:

Site-to-site

Site-to-site with Dynamic Peer

Remote Access (Server Role)

Remote Access (Client Role)

Configure **Secure Gateway** IP as the Branch's WAN IP address (in the example, 172.100.30.40). Then, type a secure **Pre-Shared Key** (8-32 characters).

Set **Local Policy** to be the IP address range of the network connected to the ZyWALL/USG (HQ) and **Remote Policy** to be the IP address range of the network connected to the ZyWALL/USG (Branch).

**Quick Setup > VPN Setup Wizard > Wizard Type > VPN Settings (Configuration)**

VPN Setup Wizard

---

Wizard Type > **VPN Settings** > Wizard Completed

1
2
3

**Express Settings**

**Configuration**

Secure Gateway:  (IP or FQDN)

Pre-Shared Key:

Local Policy (IP/Mask):

Remote Policy (IP/Mask):

This screen provides a read-only summary of the VPN tunnel. Click **Save**.

**Quick Setup > VPN Setup Wizard > Welcome > Wizard Type > VPN Settings (Summary)**

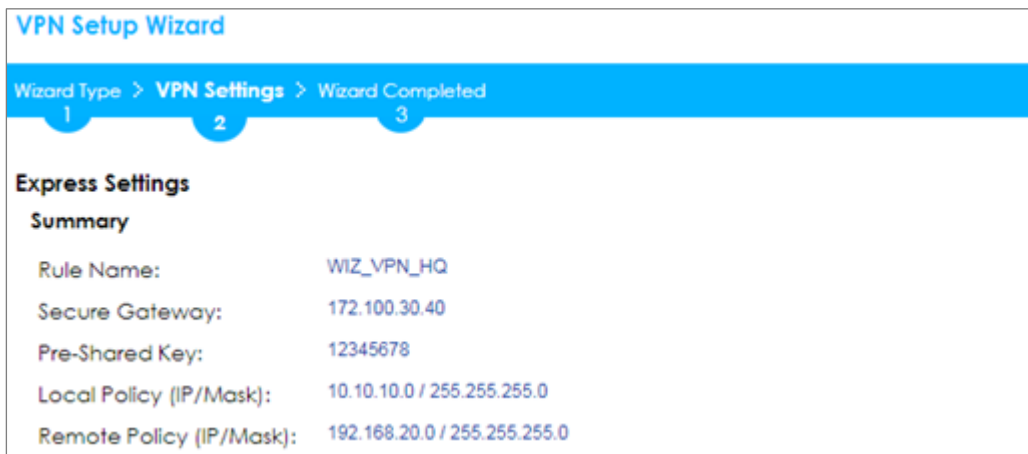

Now the rule is configured on the ZyWALL/USG. The Phase 1 rule settings appear in the **VPN > IPSec VPN > VPN Gateway** screen and the Phase 2 rule settings appear in the **VPN > IPSec VPN > VPN Connection** screen. Click **Close** to exit the wizard.

**Quick Setup > VPN Setup Wizard > Welcome > Wizard Type > VPN Settings > Wizard Completed**

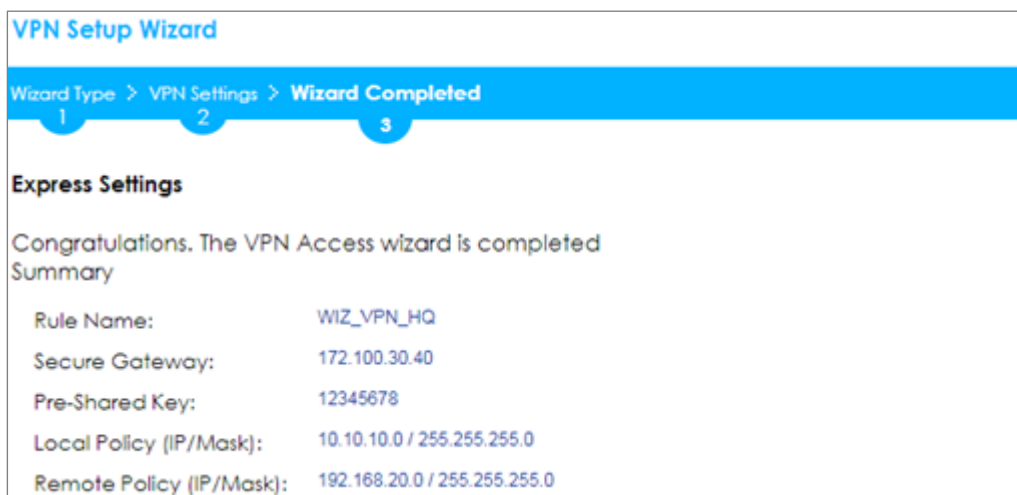

Go to **CONFIGURATION > VPN > IPSec VPN > VPN Gateway > Show Advanced Settings**. Configure **Authentication > Peer ID Type** as **Any** to let the ZyWALL/USG does not require to check the identity content of the remote IPSec router.



**CONFIGURATION > VPN > IPSec VPN > VPN Gateway > Show Advanced  
Settings > Authentication > Peer ID Type**

**Authentication**

Pre-Shared Key   
 unmasked

Certificate  (See [My Certificates](#))

User Based PSK  ⓘ

⊕ **Advance**

Local ID Type:

Content:

Peer ID Type:

Content:

## Set Up the ZyWALL/USG IPSec VPN Tunnel of Corporate Network (Branch)

In the ZyWALL/USG, go to **Quick Setup > VPN Setup Wizard**, use the **VPN Settings** wizard to create a VPN rule that can be used with the FortiGate. Click **Next**.

**Quick Setup > VPN Setup Wizard > Welcome**

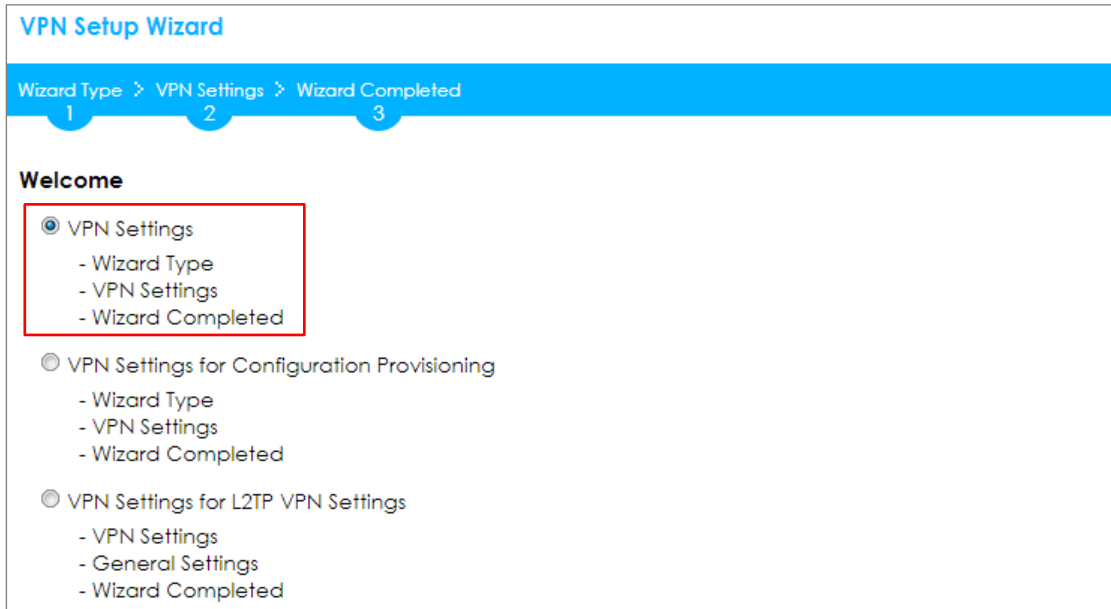

Choose **Express** to create a VPN rule with the default phase 1 and phase 2 settings and use a pre-shared key to be the authentication method. Click **Next**.

**Quick Setup > VPN Setup Wizard > Wizard Type**

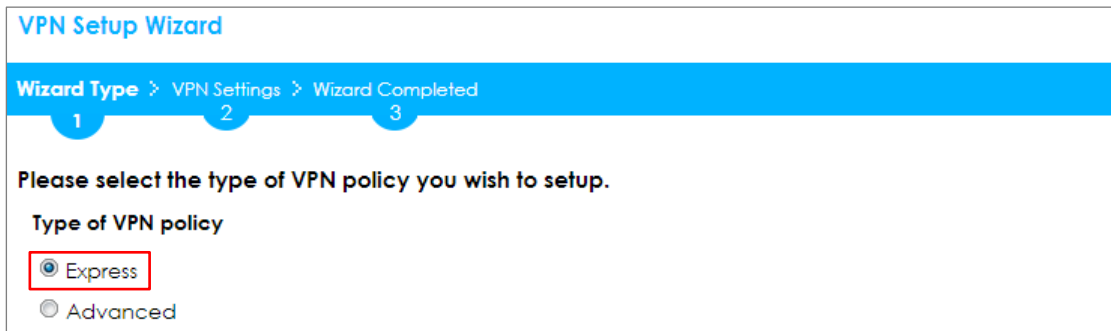

Type the **Rule Name** used to identify this VPN connection (and VPN gateway). You may use 1-31 alphanumeric characters. This value is case-sensitive. Select the rule to be **Site-to-site**. Click **Next**.

**Quick Setup > VPN Setup Wizard > Wizard Type > VPN Settings (Scenario)**

**VPN Setup Wizard**

Wizard Type > **VPN Settings** > Wizard Completed

1 2 3

**Express Settings**

**IKE Version**

IKEv1

IKEv2

**Scenario**

Rule Name:

Site-to-site

Site-to-site with Dynamic Peer

Remote Access (Server Role)

Remote Access (Client Role)

Configure **Secure Gateway** IP as the Branch's WAN IP address (in the example, 172.100.20.30). Then, type a secure **Pre-Shared Key** (8-32 characters).

Set **Local Policy** to be the IP address range of the network connected to the ZyWALL/USG (HQ) and **Remote Policy** to be the IP address range of the network connected to the ZyWALL/USG (Branch).

**Quick Setup > VPN Setup Wizard > Wizard Type > VPN Settings (Configuration)**

**VPN Setup Wizard**

Wizard Type > **VPN Settings** > Wizard Completed

1 2 3

**Express Settings**

**Configuration**

Secure Gateway:  (IP or FQDN)

Pre-Shared Key:

Local Policy (IP/Mask):

Remote Policy (IP/Mask):

This screen provides a read-only summary of the VPN tunnel. Click **Save**.

**Quick Setup > VPN Setup Wizard > Welcome > Wizard Type > VPN Settings (Summary)**

**VPN Setup Wizard**

Wizard Type > **VPN Settings** > Wizard Completed

1 2 3

**Express Settings**

**Summary**

Rule Name:	WIZ_VPN_Branch
Secure Gateway:	172.100.20.30
Pre-Shared Key:	12345678
Local Policy (IP/Mask):	192.168.20.0 / 255.255.255.0
Remote Policy (IP/Mask):	10.10.10.0 / 255.255.255.0

Now the rule is configured on the ZyWALL/USG. The Phase 1 rule settings appear in the **VPN > IPSec VPN > VPN Gateway** screen and the Phase 2 rule settings appear in the **VPN > IPSec VPN > VPN Connection** screen. Click **Close** to exit the wizard.

**Quick Setup > VPN Setup Wizard > Welcome > Wizard Type > VPN Settings > Wizard Completed**

**VPN Setup Wizard**

Wizard Type > VPN Settings > **Wizard Completed**

1 2 3

**Express Settings**

Congratulations. The VPN Access wizard is completed

**Summary**

Rule Name:	WIZ_VPN_Branch
Secure Gateway:	172.100.20.30
Pre-Shared Key:	12345678
Local Policy (IP/Mask):	192.168.20.0 / 255.255.255.0
Remote Policy (IP/Mask):	10.10.10.0 / 255.255.255.0

Go to **CONFIGURATION > VPN > IPSec VPN > VPN Gateway > Show Advanced Settings**. Configure **Authentication > Peer ID Type** as **Any** to let the ZyWALL/USG does not require to check the identity content of the remote IPSec router.

**CONFIGURATION > VPN > IPSec VPN > VPN Gateway > Show Advanced  
Settings > Authentication > Peer ID Type**

**Authentication**

Pre-Shared Key   
 unmasked

Certificate  (See [My Certificates](#))

User Based PSK  ⓘ

Advance

Local ID Type:

Content:

Peer ID Type:

Content:

## Set Up the NAT Router (Using ZyWALL USG device in this example)

Go to **CONFIGURATION > Network > NAT > Add**. Select the **Incoming Interface** on which packets for the NAT rule must be received. Specified the **User-**

Defined **Original IP** field and Type the translated destination IP address that this NAT rule supports.

## CONFIGURATION > Network > NAT > Add

General Settings	
<input checked="" type="checkbox"/> Enable Rule	
Rule Name:	VPN_NAT
Port Mapping Type	
Classification:	<input type="radio"/> Virtual Server <input checked="" type="radio"/> 1:1 NAT <input type="radio"/> Many 1:1 NAT
Mapping Rule	
Incoming Interface:	ge1
Original IP:	User Defined
User-Defined Original IP:	172.100.20.30 (IP Address)
Mapped IP:	User Defined
User-Defined Mapped IP:	192.168.1.33 (IP Address)
Port Mapping Type:	any

Go to **CONFIGURATION > Security Policy > Policy Control**. IP forwarding must be enabled at the firewall for the following IP protocols and UDP ports:

IP protocol = 50 → Used by data path (ESP)

IP protocol = 51 → Used by data path (AH)

UDP Port Number = 500 → Used by IKE (IPSec control path)

UDP Port Number = 4500 → Used by NAT-T (IPsec NAT traversal)

## CONFIGURATION > Security Policy > Policy Control

**General Settings**

Enable Policy Control

**IPv4 Configuration**

Allow Asymmetrical Route

Pri...	St...	Name	From	To	IPv4 Sou...	IPv4 Des...	Service	User	Schedule
1		LAN_Outgoing	<a href="#">LAN</a>	any (Exc...	any	any	any	any	none
2		DMZ_to_WAN	<a href="#">DMZ</a>	<a href="#">WAN</a>	any	any	any	any	none
3		IPSec_VPN_Ou...	<a href="#">IPSec_...</a>	any (Exc...	any	any	any	any	none
4		SSL_VPN_Outg...	<a href="#">SSL_VPN</a>	any (Exc...	any	any	any	any	none
5		TUNNEL_Outg...	<a href="#">TUNNEL</a>	any (Exc...	any	any	any	any	none
6		LAN_to_Device	<a href="#">LAN</a>	ZyWALL	any	any	any	any	none
7		DMZ_to_Device	<a href="#">DMZ</a>	ZyWALL	any	any	<a href="#">Default_Allow_DMZ_To_ZyWALL</a>	any	none
8		WAN_to_Device	<a href="#">WAN</a>	ZyWALL	any	any	<a href="#">Default_Allow_WAN_To_ZyWALL</a>	any	none
9		IPSec_VPN_to_...	<a href="#">IPSec_...</a>	ZyWALL	any	any	any	any	none
10		SSL_VPN_to_D...	<a href="#">SSL_VPN</a>	ZyWALL	any	any	any	any	none
11		TUNNEL_to_De...	<a href="#">TUNNEL</a>	ZyWALL	any	any	any	any	none
D...			any	any	any	any			

**Default\_Allow\_WAN\_To\_ZyWALL**

**Description:**  
System Default Allow From WAN To ZyWALL

**Members:**

- AH
- ESP
- IKE
- NATT
- GRE
- RRRP

## Test the IPSec VPN Tunnel

Go to ZyWALL/USG **CONFIGURATION > VPN > IPSec VPN > VPN Connection**, click **Connect** on the upper bar. The **Status** connect icon is lit when the interface is connected.

## CONFIGURATION > VPN > IPSec VPN > VPN Connection

#	Status	Name	VPN Gateway	Gateway IP	Version	Policy
1		WIZ_VPN_HQ	WIZ_VPN_HQ	IPv4		<a href="#">WIZ_VPN_HQ_LOCAL/WIZ_VPN_HQ_REMOTE</a>

Page 1 of 1 | Show 50 items | Displaying 1 - 1 of 1

Go to ZyWALL/USG **MONITOR > VPN Monitor > IPSec** and verify the tunnel **Up Time** and **Inbound (Bytes)/Outbound (Bytes)** Traffic.

## MONITOR > VPN Monitor > IPSec

#	Name	Policy	My Address	Secure Gateway	Up Time	Timeout	Inbound(By...	Outbound(...
1	WIZ_VPN_HQ	10.10.10.0/24<>192.168.20.0/24	192.168.1.33	P: 172.100.30.40:4500	14	86406	0(0 bytes)	0(0 bytes)

Page 1 of 1 | Show 50 items | Displaying 1 - 1 of 1

To test whether or not a tunnel is working, ping from a computer at one site to a computer at the other. Ensure that both computers have Internet access (via the IPsec devices).

### PC behind ZyWALL/USG (HQ) > Window 7 > cmd > ping 192.168.20.33

```
C:\Documents and Settings\ZYXEL>ping 192.168.20.33

Pinging 192.168.20.33 with 32 bytes of data:

Reply from 192.168.20.33: bytes=32 time=27ms TTL=43
Reply from 192.168.20.33: bytes=32 time=32ms TTL=43
Reply from 192.168.20.33: bytes=32 time=26ms TTL=43
Reply from 192.168.20.33: bytes=32 time=27ms TTL=43

Ping statistics for 192.168.20.33:
    Packets: Sent = 4, Received = 4, Lost = 0 (0% loss),
    Approximate round trip times in milli-seconds:
        Minimum = 26ms, Maximum = 32ms, Average = 28ms
```

### PC behind ZyWALL/USG (Branch) > Window 7 > cmd > ping 10.10.10.33

```
C:\Documents and Settings\ZYXEL>ping 10.10.10.33

Pinging 10.10.10.33 with 32 bytes of data:

Reply from 10.10.10.33: bytes=32 time=18ms TTL=54
Reply from 10.10.10.33: bytes=32 time=17ms TTL=54
Reply from 10.10.10.33: bytes=32 time=17ms TTL=54
Reply from 10.10.10.33: bytes=32 time=16ms TTL=54

Ping statistics for 10.10.10.33:
    Packets: Sent = 4, Received = 4, Lost = 0 (0% loss),
    Approximate round trip times in milli-seconds:
        Minimum = 16ms, Maximum = 18ms, Average = 17ms
```

## What Could Go Wrong?

If you see below [info] or [error] log message, please check ZyWALL/USG Phase 1 Settings. Both ZyWALL/USG at the HQ and Branch sites must use the same Pre-Shared Key, Encryption, Authentication method, DH key group and ID Type to establish the IKE SA.

### MONITOR > Log



Priority	Category	Message	Note
info	IKE	Recv:[NOTIFY:INVALID_COOKIE]	IKE_LOG
info	IKE	Send:[ID][HASH][NOTIFY:INITIAL_CONTACT]	IKE_LOG
Priority	Category	Message	Note
error	IPSec	SPI: 0x0 (0) SEQ: 0x0 (0) No rule found, Dropping TCP packet	IPSec
error	IPSec	SPI: 0x0 (0) SEQ: 0x0 (0) No rule found, Dropping TCP packet	IPSec
info	IKE	[COOKIE] Invalid cookie, no sa found	IKE_LOG
Priority	Category	Message	Note
info	IKE	Recv:[HASH][NOTIFY:NO_PROPOSAL_CHOSEN]	IKE_LOG

If you see that Phase 1 IKE SA process done but still get below [info] log message, please check ZyWALL/USG Phase 2 Settings. Both ZyWALL/USG at the HQ and Branch sites must use the same Protocol, Encapsulation, Encryption, Authentication method and PFS to establish the IKE SA.

### MONITOR > Log

19	2017-09-11 ...	info	IKE	[SA] : No proposal chosen	IKE_LOG
20	2017-09-11 ...	info	IKE	[ID] : Tunnel [Server] Phase 2 Local policy mismatch	IKE_LOG
31	2017-09-11 ...	info	IKE	Send:[HASH][SA][NONCE][ID][ID]	IKE_LOG
32	2017-09-11 ...	info	IKE	Phase 1 IKE SA process done	IKE_LOG

Make sure the both ZyWALL/USG at the HQ and Branch sites security policies allow IPSec VPN traffic. IKE uses UDP port 500, AH uses IP protocol 51, and ESP uses IP protocol 50.

Default NAT traversal is enable on ZyWALL/USG, please make sure the remote IPSec device must also have NAT traversal enabled.

## How to Configure Hub-and-Spoke IPSec VPN

This is an example of a hub-and-spoke VPN with the HQ ZyWALL/USG as the hub and spoke VPNs to Branches A and B. When the VPN tunnel is configured, traffic passes between branches via the hub (HQ). Traffic can also pass between spoke-and-spoke through the hub. Here are two methods to set up hub-and-spoke VPN connections: 1. With VPN Concentrator 2. Without VPN Concentrator.

With just two branch offices, you could just manually set up VPN tunnels between HQ and the branches. With many branches it's best to use the VPN Concentrator to set up branch-HQ tunnels automatically.

## ZyWALL/USG Hub-and-Spoke VPN Example

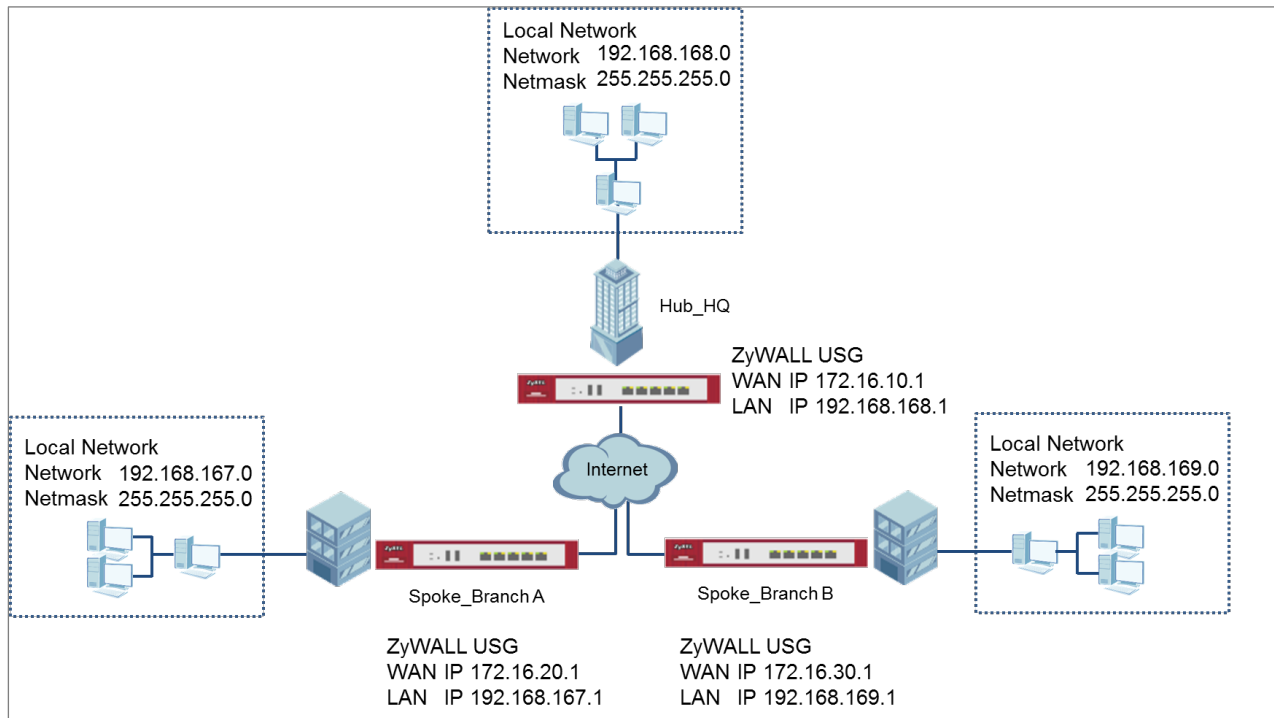

 Note: All network IP addresses and subnet masks are used as examples in this article. Please replace them with your actual network IP addresses and subnet masks. This example was tested using USG310 (Firmware Version: ZLD 4.25).

## Set Up the IPSec VPN Tunnel on the ZyWALL/USG by Using VPN Concentrator Hub\_HQ-to-Branch\_A

In the ZyWALL/USG, go to **Quick Setup > VPN Setup Wizard**, use the **VPN Settings** wizard to create a VPN rule that can be used with the remote ZyWALL/USG. Click **Next**.

## Quick Setup > VPN Setup Wizard > Welcome

VPN Setup Wizard

Wizard Type > VPN Settings > Wizard Completed

1 2 3

**Welcome**

- VPN Settings
  - Wizard Type
  - VPN Settings
  - Wizard Completed
- VPN Settings for Configuration Provisioning
  - Wizard Type
  - VPN Settings
  - Wizard Completed
- VPN Settings for L2TP VPN Settings
  - VPN Settings
  - General Settings
  - Wizard Completed

Choose **Express** to create a VPN rule with the default phase 1 and phase 2 settings and use a pre-shared key to be the authentication method. Click **Next**.

## Quick Setup > VPN Setup Wizard > Welcome > Wizard Type

VPN Setup Wizard

Wizard Type > VPN Settings > Wizard Completed

1 2 3

**Please select the type of VPN policy you wish to setup.**

**Type of VPN policy**

- Express
- Advanced

Type the **Rule Name** used to identify this VPN connection (and VPN gateway). You may use 1-31 alphanumeric characters. This value is case-sensitive. Select the rule to be **Site-to-site**. Click **Next**.

## Quick Setup > VPN Setup Wizard > Wizard Type > VPN Settings (Scenario)

**VPN Setup Wizard**

Wizard Type > **VPN Settings** > Wizard Completed

1
2
3

**Express Settings**

**IKE Version**

IKEv1  
 IKEv2

**Scenario**

Rule Name:

Site-to-site  
 Site-to-site with Dynamic Peer  
 Remote Access (Server Role)  
 Remote Access (Client Role)

Then, configure the **Secure Gateway** IP as the **Branch A**'s Gateway IP address (in the example, 172.16.20.1). Type a secure **Pre-Shared Key** (8-32 characters) which must match your **Branch A**'s Pre-Shared Key.

Set **Local Policy** to be the IP address range of the network connected to the **Hub\_HQ** and **Remote Policy** to be the IP address range of the network connected to the **Branch A**. Click **OK**.

**Quick Setup > VPN Setup Wizard > Wizard Type > VPN Settings (Configuration)**

**VPN Setup Wizard**

Wizard Type > **VPN Settings** > Wizard Completed  
1 2 3

**Express Settings**

**Configuration**

Secure Gateway:	172.16.20.1	(IP or FQDN)
Pre-Shared Key:	12345678	
Local Policy (IP/Mask):	192.168.168.0	/ 255.255.255.0
Remote Policy (IP/Mask):	192.168.167.0	/ 255.255.255.0

This screen provides a read-only summary of the VPN tunnel. Click **Save**.

**Quick Setup > VPN Setup Wizard > Wizard Type > VPN Settings (Summary)**

**VPN Setup Wizard**

Wizard Type > **VPN Settings** > Wizard Completed  
1 2 3

**Express Settings**

**Summary**

Rule Name:	Hub_HQ-to-Branch_A
Secure Gateway:	172.16.20.1
Pre-Shared Key:	12345678
Local Policy (IP/Mask):	192.168.168.0 / 255.255.255.0
Remote Policy (IP/Mask):	192.168.167.0 / 255.255.255.0

Now the rule is configured on the ZyWALL/USG. The Phase 1 rule settings appear in the **VPN > IPSec VPN > VPN Gateway** screen and the Phase 2 rule settings appear in the **VPN > IPSec VPN > VPN Connection** screen. Click **Close** to exit the wizard.

**Quick Setup > VPN Setup Wizard > Wizard Type > VPN Settings > Wizard Completed**

### VPN Setup Wizard

Wizard Type > VPN Settings > Wizard Completed

1 2 3

#### Express Settings

Congratulations. The VPN Access wizard is completed

Summary

Rule Name:	Hub_HQ-to-Branch_A
Secure Gateway:	172.16.20.1
Pre-Shared Key:	12345678
Local Policy (IP/Mask):	192.168.168.0 / 255.255.255.0
Remote Policy (IP/Mask):	192.168.167.0 / 255.255.255.0

## Hub\_HQ-to-Branch\_B

In the ZyWALL/USG, go to **Quick Setup > VPN Setup Wizard**, use the **VPN Settings** wizard to create a VPN rule that can be used with the remote ZyWALL/USG. Click **Next**.

**Quick Setup > VPN Setup Wizard > Welcome**

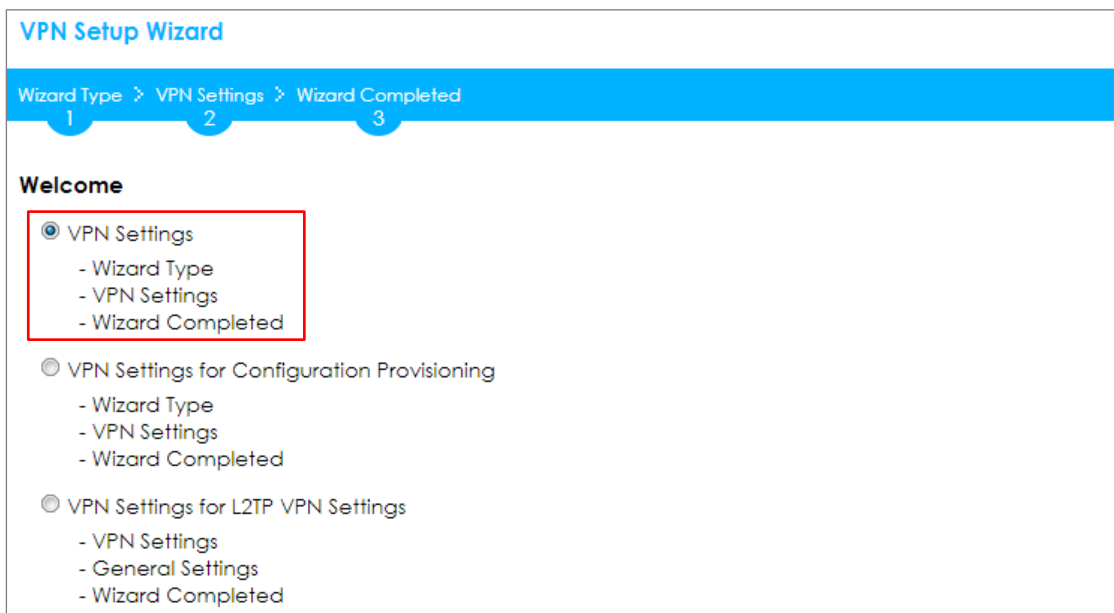

Choose **Express** to create a VPN rule with the default phase 1 and phase 2 settings and use a pre-shared key to be the authentication method. Click **Next**.

**Quick Setup > VPN Setup Wizard > Welcome > Wizard Type**

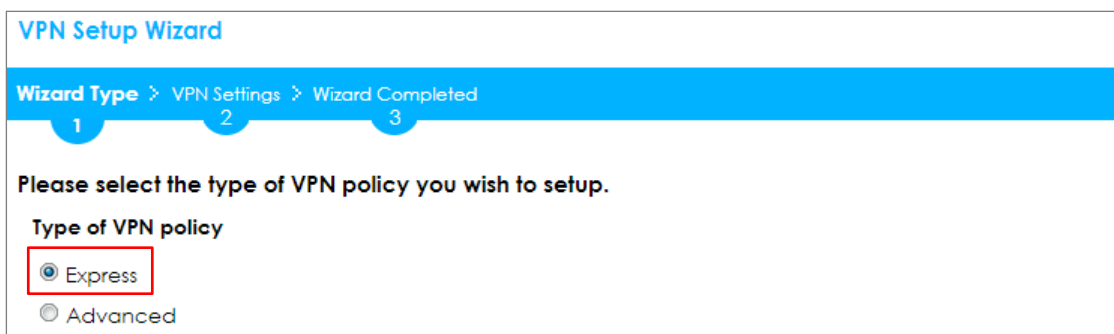

Type the **Rule Name** used to identify this VPN connection (and VPN gateway). You may use 1-31 alphanumeric characters. This value is case-sensitive. Select the rule to be **Site-to-site**. Click **Next**.

**Quick Setup > VPN Setup Wizard > Wizard Type > VPN Settings (Scenario)**

### VPN Setup Wizard

Wizard Type >
VPN Settings >
Wizard Completed

1
2
3

#### Express Settings

**IKE Version**

IKEv1

IKEv2

**Scenario**

Rule Name:

Site-to-site

Site-to-site with Dynamic Peer

Remote Access (Server Role)

Remote Access (Client Role)

Then, configure the **Secure Gateway** IP as the **Branch B**'s Gateway IP address (in the example, 172.16.30.1). Type a secure **Pre-Shared Key** (8-32 characters) which must match your **Branch B**'s Pre-Shared Key.

Set **Local Policy** to be the IP address range of the network connected to the **Hub\_HQ** and **Remote Policy** to be the IP address range of the network connected to the **Branch B**. Click **OK**.



## Quick Setup > VPN Setup Wizard > Wizard Type > VPN Settings (Configuration)

**VPN Setup Wizard**

Wizard Type > **VPN Settings** > Wizard Completed

1      2      3

**Express Settings**

**Configuration**

Secure Gateway:	172.16.30.1	(IP or FQDN)
Pre-Shared Key:	12345678	
Local Policy (IP/Mask):	192.168.168.0	255.255.255.0
Remote Policy (IP/Mask):	192.168.169.0	255.255.255.0

This screen provides a read-only summary of the VPN tunnel. Click **Save**.

## Quick Setup > VPN Setup Wizard > Wizard Type > VPN Settings (Summary)

**VPN Setup Wizard**

Wizard Type > **VPN Settings** > Wizard Completed

1      2      3

**Express Settings**

**Summary**

Rule Name:	Hub_HQ-to-Branch_B
Secure Gateway:	172.16.30.1
Pre-Shared Key:	12345678
Local Policy (IP/Mask):	192.168.168.0 / 255.255.255.0
Remote Policy (IP/Mask):	192.168.169.0 / 255.255.255.0

Now the rule is configured on the ZyWALL/USG. The Phase 1 rule settings appear in the **VPN > IPSec VPN > VPN Gateway** screen and the Phase 2 rule settings appear in the **VPN > IPSec VPN > VPN Connection** screen. Click **Close** to exit the wizard.

## Quick Setup > VPN Setup Wizard > Wizard Type > VPN Settings > Wizard Completed

### VPN Setup Wizard

Wizard Type > VPN Settings > Wizard Completed

1 2 3

#### Express Settings

Congratulations. The VPN Access wizard is completed

Summary

Rule Name:	Hub_HQ-to-Branch_B
Secure Gateway:	172.16.30.1
Pre-Shared Key:	12345678
Local Policy (IP/Mask):	192.168.168.0 / 255.255.255.0
Remote Policy (IP/Mask):	192.168.169.0 / 255.255.255.0

## Hub\_HQ Concentrator

In the ZyWALL/USG, go to **CONFIGURATION > VPN > IPSec VPN > Concentrator**, add a VPN Concentrator rule. Select VPN tunnels to be in the same member group and click **Save**.

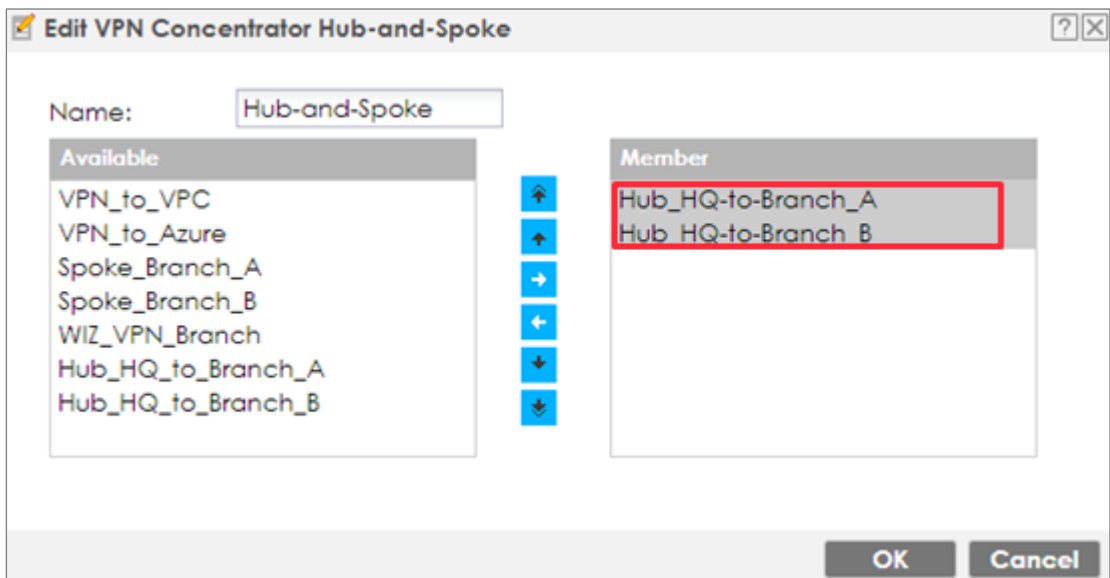
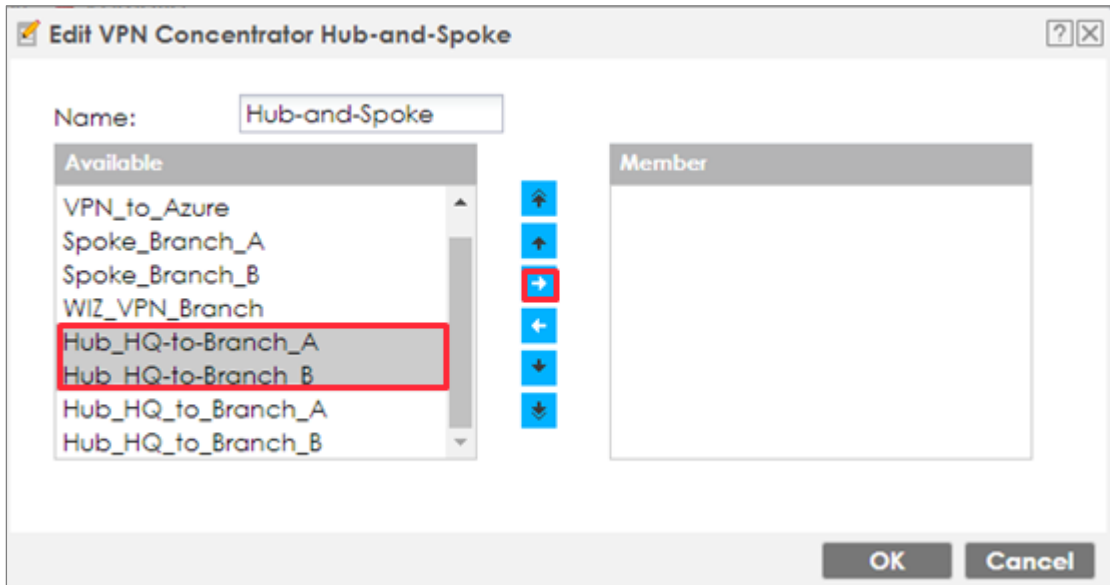

## Spoke\_Branch\_A

In the ZyWALL/USG, go to **Quick Setup > VPN Setup Wizard**, use the **VPN Settings** wizard to create a VPN rule that can be used with the remote ZyWALL/USG. Click **Next**.

**Quick Setup > VPN Setup Wizard > Welcome**

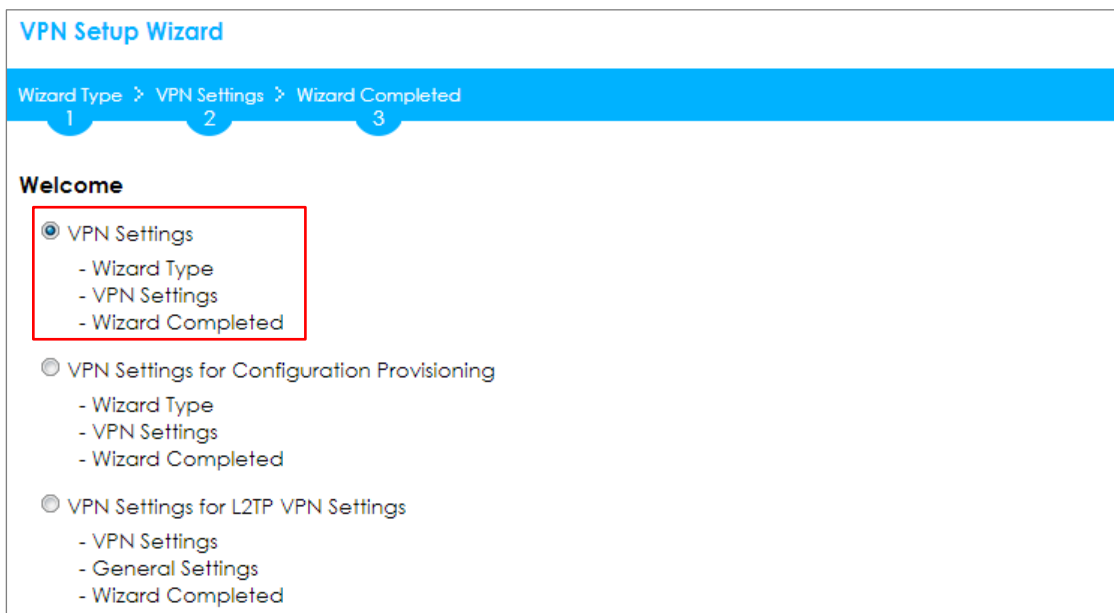

Choose **Express** to create a VPN rule with the default phase 1 and phase 2 settings and use a pre-shared key to be the authentication method. Click **Next**.

**Quick Setup > VPN Setup Wizard > Welcome > Wizard Type**

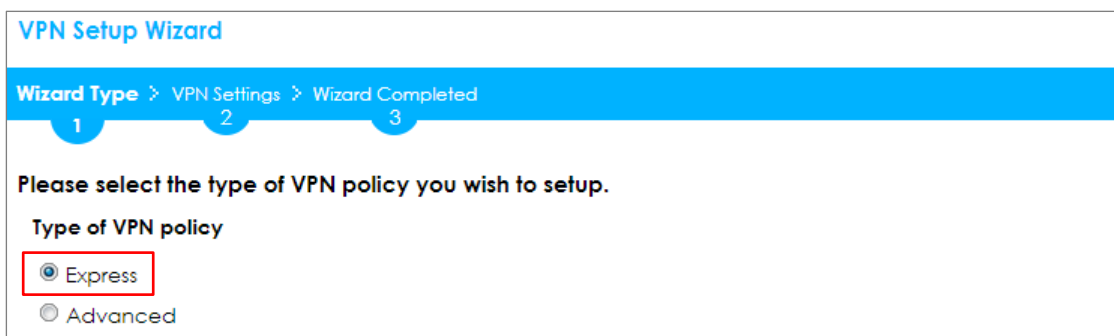

Type the **Rule Name** used to identify this VPN connection (and VPN gateway). You may use 1-31 alphanumeric characters. This value is case-sensitive. Select the rule to be **Site-to-site**. Click **Next**.

**Quick Setup > VPN Setup Wizard > Wizard Type > VPN Settings (Scenario)**

**VPN Setup Wizard**

Wizard Type > **VPN Settings** > Wizard Completed

1      2      3

**Express Settings**

**IKE Version**

IKEv1

IKEv2

**Scenario**

Rule Name:

Site-to-site

Site-to-site with Dynamic Peer

Remote Access (Server Role)

Remote Access (Client Role)

Then, configure the **Secure Gateway** IP as the **Hub\_HQ**'s Gateway IP address (in the example, 172.16.10.1). Type a secure **Pre-Shared Key** (8-32 characters) which must match your **Hub\_HQ**'s Pre-Shared Key.

Set **Local Policy** to be the IP address range of the network connected to the **Spoke\_Branch\_A** and **Remote Policy** to be the IP address range of the network connected to the **Hub\_HQ**. Click **OK**.

**Quick Setup > VPN Setup Wizard > Wizard Type > VPN Settings (Configuration)**

**VPN Setup Wizard**

Wizard Type > **VPN Settings** > Wizard Completed

1      2      3

**Express Settings**

**Configuration**

Secure Gateway:	172.16.10.1	(IP or FQDN)
Pre-Shared Key:	12345678	
Local Policy (IP/Mask):	192.168.167.0	/255.255.255.0
Remote Policy (IP/Mask):	192.168.168.0	/255.255.255.0

This screen provides a read-only summary of the VPN tunnel. Click **Save**.

**Quick Setup > VPN Setup Wizard > Wizard Type > VPN Settings (Summary)**

**VPN Setup Wizard**

Wizard Type > **VPN Settings** > Wizard Completed

1      2      3

**Express Settings**

**Summary**

Rule Name:	Spoke_Branch_A
Secure Gateway:	172.16.10.1
Pre-Shared Key:	12345678
Local Policy (IP/Mask):	192.168.167.0 / 255.255.255.0
Remote Policy (IP/Mask):	192.168.168.0 / 255.255.255.0

Now the rule is configured on the ZyWALL/USG. The Phase 1 rule settings appear in the **VPN > IPSec VPN > VPN Gateway** screen and the Phase 2 rule settings appear in the **VPN > IPSec VPN > VPN Connection** screen. Click **Close** to exit the wizard.

**Quick Setup > VPN Setup Wizard > Wizard Type > VPN Settings > Wizard Completed**

### VPN Setup Wizard

Wizard Type > VPN Settings > Wizard Completed

1 2 3

#### Express Settings

Congratulations. The VPN Access wizard is completed  
Summary

Rule Name:	Spoke_Branch_A
Secure Gateway:	172.16.10.1
Pre-Shared Key:	12345678
Local Policy (IP/Mask):	192.168.167.0 / 255.255.255.0
Remote Policy (IP/Mask):	192.168.168.0 / 255.255.255.0

Go to **Network > Routing > Policy Route** to add a **Policy Route** to allow traffic from **Spoke\_Branch\_A** to **Spoke\_Branch\_B**.

Click **Create new Object** and set **Address** to be the local network behind the **Spoke\_Branch\_B**. Select **Source Address** to be the local network behind the

**Spoke\_Branch\_A**. Then, scroll down the **Destination Address** list to choose the newly created **Spoke\_Branch\_B\_LOCAL** address. Click **OK**.

**Network > Routing > Policy Route**

+ **Add Policy Route**

Show Advanced Settings Create new Object ▼

**Criteria**

User:	any ▼
Incoming:	any (Excluding ZyV ▼
Source Address:	Spock_Branch_A_L ▼
Destination Address:	Spock_Branch_B_L ▼
DSCP Code:	any ▼
Schedule:	none ▼
Service:	any ▼

**Next-Hop**

Type:	VPN Tunnel ▼
VPN Tunnel:	Spoke_Branch_A ▼

## Spoke\_Branch\_B

In the ZyWALL/USG, go to **Quick Setup > VPN Setup Wizard**, use the **VPN Settings** wizard to create a VPN rule that can be used with the remote ZyWALL/USG. Click **Next**.



## Quick Setup > VPN Setup Wizard > Welcome

VPN Setup Wizard

Wizard Type > VPN Settings > Wizard Completed

1 2 3

**Welcome**

- VPN Settings
  - Wizard Type
  - VPN Settings
  - Wizard Completed
- VPN Settings for Configuration Provisioning
  - Wizard Type
  - VPN Settings
  - Wizard Completed
- VPN Settings for L2TP VPN Settings
  - VPN Settings
  - General Settings
  - Wizard Completed

Choose **Express** to create a VPN rule with the default phase 1 and phase 2 settings and use a pre-shared key to be the authentication method. Click **Next**.

## Quick Setup > VPN Setup Wizard > Welcome > Wizard Type

VPN Setup Wizard

Wizard Type > VPN Settings > Wizard Completed

1 2 3

**Please select the type of VPN policy you wish to setup.**

Type of VPN policy

- Express
- Advanced

Type the **Rule Name** used to identify this VPN connection (and VPN gateway). You may use 1-31 alphanumeric characters. This value is case-sensitive. Select the rule to be **Site-to-site**. Click **Next**.

## Quick Setup > VPN Setup Wizard > Wizard Type > VPN Settings (Scenario)

VPN Setup Wizard

Wizard Type > VPN Settings > Wizard Completed

1 2 3

**Express Settings**

**IKE Version**

IKEv1

IKEv2

**Scenario**

Rule Name:

Site-to-site

Site-to-site with Dynamic Peer

Remote Access (Server Role)

Remote Access (Client Role)

Then, configure the **Secure Gateway** IP as the **Hub\_HQ**'s Gateway IP address (in the example, 172.16.10.1). Type a secure **Pre-Shared Key** (8-32 characters) which must match your **Hub\_HQ**'s Pre-Shared Key.

Set **Local Policy** to be the IP address range of the network connected to the **Spoke\_Branch\_B** and **Remote Policy** to be the IP address range of the network connected to the **Hub\_HQ**. Click **OK**.

**Quick Setup > VPN Setup Wizard > Wizard Type > VPN Settings (Configuration)**

**VPN Setup Wizard**

Wizard Type > **VPN Settings** > Wizard Completed  
1
2
3

**Express Settings**

**Configuration**

Secure Gateway:	172.168.10.1	(IP or FQDN)
Pre-Shared Key:	12345678	
Local Policy (IP/Mask):	192.168.169.0	/ 255.255.255.0
Remote Policy (IP/Mask):	192.168.168.0	/ 255.255.255.0

This screen provides a read-only summary of the VPN tunnel. Click **Save**.

**Quick Setup > VPN Setup Wizard > Wizard Type > VPN Settings (Summary)**

**VPN Setup Wizard**

Wizard Type > **VPN Settings** > Wizard Completed  
1
2
3

**Express Settings**

**Summary**

Rule Name:	Spoke_Branch_B
Secure Gateway:	172.16.10.1
Pre-Shared Key:	12345678
Local Policy (IP/Mask):	192.168.169.0 / 255.255.255.0
Remote Policy (IP/Mask):	192.168.168.0 / 255.255.255.0

Now the rule is configured on the ZyWALL/USG. The Phase 1 rule settings appear in the **VPN > IPSec VPN > VPN Gateway** screen and the Phase 2 rule settings appear in the **VPN > IPSec VPN > VPN Connection** screen. Click **Close** to exit the wizard.

**Quick Setup > VPN Setup Wizard > Wizard Type > VPN Settings > Wizard Completed**

**VPN Setup Wizard**

Wizard Type > VPN Settings > **Wizard Completed**

1      2      3

**Express Settings**

Congratulations. The VPN Access wizard is completed

Summary

Rule Name:	Spoke_Branch_B
Secure Gateway:	172.16.10.1
Pre-Shared Key:	12345678
Local Policy (IP/Mask):	192.168.169.0 / 255.255.255.0
Remote Policy (IP/Mask):	192.168.168.0 / 255.255.255.0

Go to **Network > Routing > Policy Route** to add a Policy Route to allow traffic from **Spoke\_Branch\_B** to **Spoke\_Branch\_A**.

Click **Create new Object** and set **Address** to be the local network behind the **Spoke\_Branch\_A**. Select **Source Address** to be the local network behind the

**Spoke\_Branch\_B**. Then, scroll down the **Destination Address** list to choose the newly created **Spoke\_Branch\_A\_LOCAL** address. Click **OK**.

**Network > Routing > Policy Route**

### + Add Policy Route

Show Advanced Settings Create new Object ▼

---

#### Criteria

User:	any ▼
Incoming:	any (Excluding ZyV ▼
Source Address:	Spock_Branch_B_L ▼
Destination Address:	Spock_Branch_A_L ▼
DSCP Code:	any ▼
Schedule:	none ▼
Service:	any ▼

---

#### Next-Hop

Type:	VPN Tunnel ▼
VPN Tunnel:	Spoke_Branch_B ▼

**Test the IPSec VPN Tunnel**

Go to ZyWALL/USG **CONFIGURATION > VPN > IPsec VPN > VPN Connection**, click **Connect** on the upper bar. The **Status** connect icon is lit when the interface is connected.

## Hub\_HQ > CONFIGURATION > VPN > IPsec VPN > VPN Connection

IPv4 Configuration				
#	Status	Name	VPN Gateway	Policy
1		Hub_HQ-to-Branch_A	Hub_HQ-to-Branch_A	<a href="#">Hub_HQ-to-Branch_A_LOCAL/Hub_HQ-to-Branch_A_REMOTE</a>
2		Hub_HQ-to-Branch_B	Hub_HQ-to-Branch_B	<a href="#">Hub_HQ-to-Branch_B_LOCAL/Hub_HQ-to-Branch_B_REMOTE</a>

Page 1 of 1 Show 50 items Displaying 1 - 2 of 2

## Spoke\_Branch\_A > CONFIGURATION > VPN > IPsec VPN > VPN Connection

IPv4 Configuration				
#	Status	Name	VPN Gateway	Policy
1		Spoke-Branch_A	Spoke-Branch_A	<a href="#">Spoke-Branch_A_LOCAL/Spoke-Branch_A_REMOTE</a>

Page 1 of 1 Show 50 items Displaying 1 - 1 of 1

## Spoke\_Branch\_B > CONFIGURATION > VPN > IPsec VPN > VPN Connection

IPv4 Configuration				
#	Status	Name	VPN Gateway	Policy
1		Spoke-Branch_B	Spoke-Branch_B	<a href="#">Spoke-Branch_B_LOCAL/Spoke-Branch_B_REMOTE</a>

Page 1 of 1 Show 50 items Displaying 1 - 1 of 1

Go to ZyWALL/USG **MONITOR > VPN Monitor > IPsec** and verify the tunnel **Up Time** and the **Inbound(Bytes)/Outbound(Bytes)** traffic. Click **Connectivity Check** to verify the result of ICMP Connectivity.

## Hub\_HQ > MONITOR > VPN Monitor > IPsec > Hub\_HQ-to-Branch\_A

#	Name	Policy	My Address	Secure Gatew...	Up Time	Timeout	Inbound(...	Outboun...
1	Hub_HQ-to-Branch_A	192.168.168.0/24<>192.168.167.0/24	172.16.10.1	P: 172.16.20.1	253	86167	0(0 bytes)	0(0 bytes)
2	Hub_HQ-to-Branch_B	192.168.168.0/24<>192.168.169.0/24	172.16.10.1	P: 172.16.30.1	68	86352	1(78 bytes)	0(0 bytes)

Page 1 of 1 Show 50 items Displaying 1 - 2 of 2

### Connectivity Check

**Connectivity Check**

IP Address:

**OK** **Cancel**

### Result

 ICMP Connectivity Check PASS on Hub\_HQ-to-Branch\_A

**OK**

Hub\_HQ > MONITOR > VPN Monitor > IPSec > Hub\_HQ-to-Branch\_B

#	Name	Policy	My Address	Secure Gatew...	Up Time	Timeout	Inbound(...	Outbound...
1	Hub_HQ-to-Branch_A	192.168.168.0/24<>192.168.167.0/24	172.16.10.1	P: 172.16.20.1	253	86167	0(0 bytes)	0(0 bytes)
2	Hub_HQ-to-Branch_B	192.168.168.0/24<>192.168.169.0/24	172.16.10.1	P: 172.16.30.1	68	86352	1(78 bytes)	0(0 bytes)

Page 1 of 1 Show 50 items Displaying 1 - 2 of 2

**Connectivity Check** [?] [X]

**Connectivity Check**

IP Address:

**OK** **Cancel**

**Result** [X]

 ICMP Connectivity Check PASS on Hub\_HQ-to-Branch\_B

**OK**

### Spoke\_Branch\_A > MONITOR > VPN Monitor > IPsec

#	Name	Policy	My Address	Secure Gat...	Up Time	Timeout	Inbound(B...	Outbound(...
1	Spoke_Branch_A	192.168.167.0/24<>192.168.168.0/24	172.16.20.1	P: 172.16.10.1	66	86354	0(0 bytes)	0(0 bytes)

Page 1 of 1 Show 50 items Displaying 1 - 1 of 1

**Connectivity Check** [?] [X]

**Connectivity Check**

IP Address:

**OK** **Cancel**



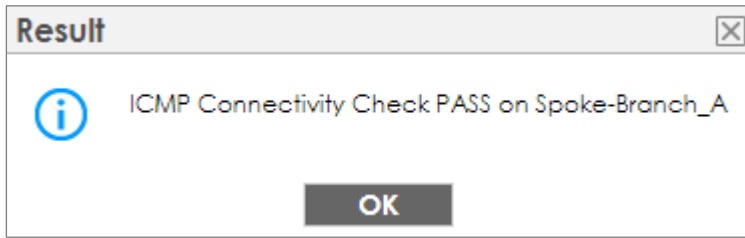

## Spoke\_Branch\_B > MONITOR > VPN Monitor > IPSec

#	Name	Policy	My Address	Secure Gat...	Up Time	Timeout	Inbound(By...	Outbound(...
1	Spoke_Branch_B	192.168.169.0/24<>192.168.168.0/24	172.16.30.1	P: 172.16.10.1	8	86412	0(0 bytes)	0(0 bytes)

Navigation: Page 1 of 1 | Show 50 items | Displaying 1 - 1 of 1

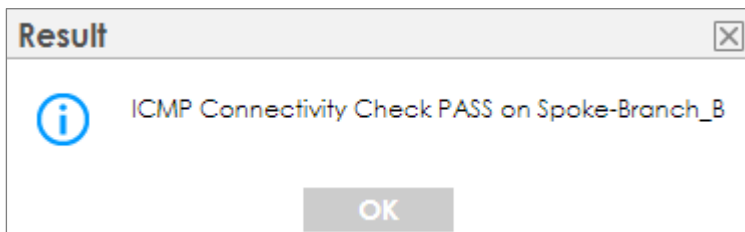
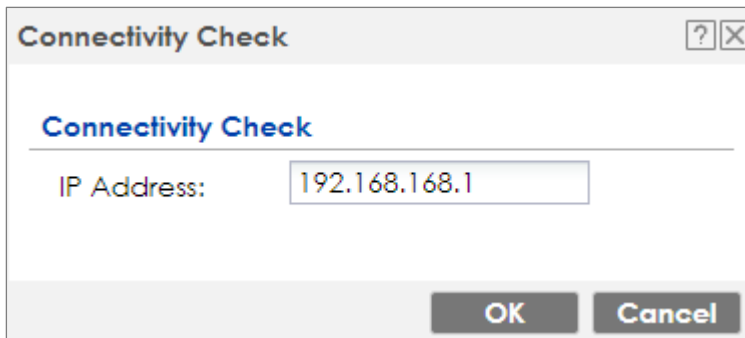

## What Could Go Wrong?

If you see [info] or [error] log message such as below, please check ZyWALL/USG Phase 1 Settings. All ZyWALL/USG units must use the same Pre-Shared Key, Encryption, Authentication method, DH key group and ID Type to establish the IKE SA.

Priority	Category	Message	Note
info	IKE	Recv:[NOTIFY:INVALID_COOKIE]	IKE_LOG
info	IKE	Send:[ID][HASH][NOTIFY:INITIAL_CONTACT]	IKE_LOG
Priority	Category	Message	Note
error	IPSec	SPI: 0x0 (0) SEQ: 0x0 (0) No rule found, Dropping TCP packet	IPSec
error	IPSec	SPI: 0x0 (0) SEQ: 0x0 (0) No rule found, Dropping TCP packet	IPSec
info	IKE	[COOKIE] Invalid cookie, no sa found	IKE_LOG
Priority	Category	Message	Note
info	IKE	Recv:[HASH][NOTIFY:NO_PROPOSAL_CHOSEN]	IKE_LOG

If you see that Phase 1 IKE SA process done but still get [info] log message as below, please check ZyWALL/USG and SonicWALL Phase 2 Settings. All ZyWALL/USG units must use the same Protocol, Encapsulation, Encryption, Authentication method and PFS to establish the IKE SA.

19	2017-09-11 ...	info	IKE	[SA] : No proposal chosen	IKE_LOG
20	2017-09-11 ...	info	IKE	[ID] : Tunnel [Server] Phase 2 Local policy mismatch	IKE_LOG
31	2017-09-11 ...	info	IKE	Send:[HASH][SA][NONCE][ID][ID]	IKE_LOG
32	2017-09-11 ...	info	IKE	Phase 1 IKE SA process done	IKE_LOG

Make sure the all ZyWALL/USG units' security policies allow IPSec VPN traffic. IKE uses UDP port 500, AH uses IP protocol 51, and ESP uses IP protocol 50.

By default, NAT traversal is enabled on ZyWALL/USG, so please make sure the remote IPSec device also has NAT traversal enabled.

## Set Up the IPSec VPN Tunnel of ZyWALL/USG without Using VPN Concentrator Hub\_HQ-to-Branch\_A

Go to **CONFIGURATION > VPN > IPSec VPN > VPN Gateway** and select **Enable**. Type the **VPN Gateway Name** used to identify this VPN gateway.

Then, configure the **Secure Gateway** IP as the **Branch A's** Gateway IP address (in the example, 172.16.20.1). Type a secure **Pre-Shared Key** (8-32 characters) which must match your **Branch A's** Pre-Shared Key and click **OK**.

### CONFIGURATION > VPN > IPSec VPN > VPN Gateway

**General Settings**

Enable

VPN Gateway Name:

**IKE Version**

IKEv1

IKEv2

---

**Gateway Settings**

**My Address**

Interface  DHCP client -- 172.16.10.1/255.255.255.

Domain Name / IPv4

**Peer Gateway Address**

Static Address

Primary

Secondary

Fall back to Primary Peer Gateway when possible

Fall Back Check Interval:  (60-86400 seconds)

Dynamic Address

### Authentication

Pre-Shared Key   unmasked

Certificate  (See [My Certificates](#))

User Based PSK  ⓘ

Advance

---

### Phase 1 Settings

SA Life Time:  (180 - 3000000 Seconds)

Negotiation Mode:

Advance

Go to **CONFIGURATION > VPN > IPSec VPN > VPN Connection** and select **Enable**. Type the **Connection Name** used to identify this VPN connection. Select scenario as **Site-to-site** and VPN Gateway which is configured in Step 1.

### CONFIGURATION > VPN > IPSec VPN > VPN Connection > General Settings and VPN Gateway

### General Settings

Enable

Advance

---

### VPN Gateway

Application Scenario

Site-to-site

Site-to-site with Dynamic Peer

Remote Access (Server Role)

Remote Access (Client Role)

Vpn Tunnel Interface

VPN Gateway:  ge2 172.16.20.1, 0.0.0.0

Click **Create new Object** on the upper bar to add the address range of the local network behind **Hub\_HQ** to **Branch\_B** and an address of local network behind **Branch A**.

**CONFIGURATION > VPN > IPSec VPN > VPN Connection > Create new Object**

### Local Policy

**Add Address Rule**

Name:

Address Type:

Starting IP Address:

End IP Address:

### Remote Policy

**Add Address Rule**

Name:

Address Type:

Network:

Netmask:

Set **Local Policy** to be **HQ-to-Branch\_B** and **Remote Policy** to **Branch\_A** which are newly created. Click **OK**.

**CONFIGURATION > VPN > IPSec VPN > VPN Connection > Policy**

**Policy**

Local policy:  RANGE, 192.168.168.0-192.168.169.0

Remote policy:  SUBNET, 192.168.167.0/24

Advance

**Phase 2 Setting**

SA Life Time:  (180 - 3000000 Seconds)

Advance

**Related Settings**

Zone:  ⓘ

## Hub\_HQ-to-Branch\_B

Go to **CONFIGURATION > VPN > IPsec VPN > VPN Gateway**, select **Enable**. Type the **VPN Gateway Name** used to identify this VPN gateway.

Then, configure the **Secure Gateway** IP as the **Branch B**'s Gateway IP address (in the example, 172.16.30.1). Type a secure **Pre-Shared Key** (8-32 characters) which must match your **Branch B**'s Pre-Shared Key and click **OK**.

### CONFIGURATION > VPN > IPsec VPN > VPN Gateway

#### General Settings

Enable

VPN Gateway Name:

**IKE Version**

IKEv1

IKEv2

---

#### Gateway Settings

**My Address**

Interface  DHCP client -- 172.16.10.1/255.255.255.  
 Domain Name / IPv4

**Peer Gateway Address**

Static **Address** i

Primary

Secondary

Fall back to Primary Peer Gateway when possible

Fall Back Check Interval:  (60-86400 seconds)

Dynamic Address i

---

#### Authentication

Pre-Shared Key   unmasked

Certificate  (See [My Certificates](#))

User Based PSK  i

Advance

Go to **CONFIGURATION > VPN > IPsec VPN > VPN Connection** and select **Enable**. Type the **Connection Name** used to identify this VPN connection. Select scenario as **Site-to-site** and VPN Gateway which is configured in Step 1.

## CONFIGURATION > VPN > IPsec VPN > VPN Connection > General Settings and VPN Gateway

**General Settings**

Enable

Connection Name:

Advance

**VPN Gateway**

Application Scenario

- Site-to-site
- Site-to-site with Dynamic Peer
- Remote Access (Server Role)
- Remote Access (Client Role)
- Vpn Tunnel Interface

VPN Gateway:  ge2 172.16.30.1, 0.0.0.0

Click **Create new Object** on the upper bar to add the address range of the local network behind **Hub\_HQ** to **Branch\_A** and an address of local network behind **Branch B**.

**CONFIGURATION > VPN > IPSec VPN > VPN Connection > Create new Object**

**Local Policy**

**Add Address Rule**

Name:

Address Type:

Starting IP Address:

End IP Address:

**Remote Policy**

**Add Address Rule**

Name:

Address Type:

Network:

Netmask:

Set **Local Policy** to be **HQ-to-Branch\_B** and **Remote Policy** to **Branch\_B** which are newly created. Click **OK**.

**CONFIGURATION > VPN > IPSec VPN > VPN Connection > Policy**

**Policy**

Local policy:  RANGE, 192.168.167.0-192.168.168.0

Remote policy:  SUBNET, 192.168.169.0/24

Advance

**Phase 2 Setting**

SA Life Time:  (180 - 3000000 Seconds)

Advance

**Related Settings**

Zone:  ⓘ



## Spoke\_Branch\_A

Go to **CONFIGURATION > VPN > IPsec VPN > VPN Gateway**, select **Enable**. Type the **VPN Gateway Name** used to identify this VPN gateway.

Then, configure the **Secure Gateway** IP as the **Hub\_HQ**'s Gateway IP address (in the example, 172.16.10.1). Type a secure **Pre-Shared Key** (8-32 characters) which must match your **Hub\_HQ**'s Pre-Shared Key and click **OK**.

### CONFIGURATION > VPN > IPsec VPN > VPN Gateway

**General Settings**

Enable

VPN Gateway Name:

**IKE Version**

IKEv1

IKEv2

**Gateway Settings**

**My Address**

Interface  DHCP client -- 172.16.20.1/255.255.255.

Domain Name / IPv4

**Peer Gateway Address**

Static Address **i**

Primary

Secondary

Fall back to Primary Peer Gateway when possible

Fall Back Check Interval:  (60-86400 seconds)

Dynamic Address **i**

### Authentication

Pre-Shared Key   unmasked

Certificate  (See [My Certificates](#))

User Based PSK  ⓘ

Advance

---

### Phase 1 Settings

SA Life Time:  (180 - 3000000 Seconds)

Negotiation Mode:

Advance

Go to **CONFIGURATION > VPN > IPSec VPN > VPN Connection** and select **Enable**. Type the **Connection Name** used to identify this VPN connection. Select scenario as **Site-to-site** and VPN Gateway which is configured in Step 1.

### CONFIGURATION > VPN > IPSec VPN > VPN Connection > General Settings and VPN Gateway

### General Settings

Enable

Connection Name:

Advance

---

### VPN Gateway

Application Scenario

Site-to-site

Site-to-site with Dynamic Peer

Remote Access (Server Role)

Remote Access (Client Role)

Vpn Tunnel Interface

VPN Gateway:  ge2 172.16.10.1, 0.0.0.0

Click **Create new Object** on the upper bar to add the address of the local network behind **Branch A** and **the** address range of the local network behind **Hub\_HQ** to **Branch\_B**.

**CONFIGURATION > VPN > IPSec VPN > VPN Connection > Create new Object**

### Local Policy

**Add Address Rule**

Name: Branch\_A

Address Type: SUBNET

Network: 192.168.167.0

Netmask: 255.255.255.0

OK Cancel

### Remote Policy

**Add Address Rule**

Name: HQ-to-Branch\_B

Address Type: RANGE

Starting IP Address: 192.168.168.0

End IP Address: 192.168.169.0

OK Cancel

Set **Local Policy** to be **Branch\_A** and **Remote Policy** to **HQ-to-Branch\_B** which are newly created. Click **OK**.

**CONFIGURATION > VPN > IPSec VPN > VPN Connection > Policy**

**Policy**

Local policy: Branch\_A SUBNET, 192.168.167.0/24

Remote policy: HQ-to-Branch\_B RANGE, 192.168.168.0-192.168.169.0

Phase 2 Setting

SA Life Time: 86400 (180 - 3000000 Seconds)

Related Settings

Zone: IPSec\_VPN

## Spoke\_Branch\_B

Go to **CONFIGURATION > VPN > IPsec VPN > VPN Gateway**, select **Enable**. Type the **VPN Gateway Name** used to identify this VPN gateway.

Then, configure the **Secure Gateway** IP as the **Hub\_HQ**'s Gateway IP address (in the example, 172.16.10.1). Type a secure **Pre-Shared Key** (8-32 characters) which must match your **Hub\_HQ**'s Pre-Shared Key and click **OK**.

### CONFIGURATION > VPN > IPsec VPN > VPN Gateway

#### General Settings

Enable

VPN Gateway Name:

**IKE Version**

IKEv1

IKEv2

---

#### Gateway Settings

**My Address**

Interface  DHCP client -- 172.16.30.1/255.255.255.

Domain Name / IPv4

**Peer Gateway Address**

Static Address i

Primary

Secondary

Fall back to Primary Peer Gateway when possible

Fall Back Check Interval:  (60-86400 seconds)

Dynamic Address i

### Authentication

Pre-Shared Key   unmasked

Certificate  (See [My Certificates](#))

User Based PSK  ⓘ

▼ Advance

### Phase 1 Settings

SA Life Time:  (180 - 3000000 Seconds)

Negotiation Mode:

▼ Advance

Go to **CONFIGURATION > VPN > IPSec VPN > VPN Connection** and select **Enable**. Type the **Connection Name** used to identify this VPN connection. Select scenario as **Site-to-site** and VPN Gateway which is configured in Step 1.

### CONFIGURATION > VPN > IPSec VPN > VPN Connection > General Settings and VPN Gateway

### General Settings

Enable

Connection Name:

▼ Advance

### VPN Gateway

Application Scenario

Site-to-site

Site-to-site with Dynamic Peer

Remote Access (Server Role)

Remote Access (Client Role)

Vpn Tunnel Interface

VPN Gateway:  ge2 172.16.10.1, 0.0.0.0

Click **Create new Object** on the upper bar to add the address of local network behind **Branch B** and address range of local network behind **Hub\_HQ** to **Branch\_A**.

**CONFIGURATION > VPN > IPSec VPN > VPN Connection > Create new Object**

### Local Policy

**Add Address Rule**

Name:

Address Type:

Network:

Netmask:

### Remote Policy

**Add Address Rule**

Name:

Address Type:

Starting IP Address:

End IP Address:

Set **Local Policy** to be **Branch\_B** and **Remote Policy** to **HQ-to-Branch\_A** which are newly created. Click **OK**.

**CONFIGURATION > VPN > IPSec VPN > VPN Connection > Policy**

**Policy**

Local policy:  SUBNET, 192.168.169.0/24

Remote policy:  RANGE, 192.168.167.0-192.168.168.0

Advance

**Phase 2 Setting**

SA Life Time:  (180 - 3000000 Seconds)

Advance

**Related Settings**

Zone:  ⓘ

## Test the IPsec VPN Tunnel

Go to ZyWALL/USG **CONFIGURATION > VPN > IPsec VPN > VPN Connection**, click **Connect** on the upper bar. The **Status** connect icon is lit when the interface is connected.

### Hub\_HQ > CONFIGURATION > VPN > IPsec VPN > VPN Connection

IPv4 Configuration				
#	Status	Name	VPN Gateway	Policy
1		Hub_HQ-to-Branch_A	Hub_HQ-to-Branch_A	<a href="#">HQ-to-Branch_B/Branch_A</a>
2		Hub_HQ-to-Branch_B	Hub_HQ-to-Branch_B	<a href="#">HQ-to-Branch_A/Branch_B</a>

Page 1 of 1 Show 50 items Displaying 1 - 2 of 2

### Spoke\_Branch\_A > CONFIGURATION > VPN > IPsec VPN > VPN Connection

IPv4 Configuration				
#	Status	Name	VPN Gateway	Policy
1		Spoke_Branch_A	Spoke_Branch_A	<a href="#">Branch_A/HQ-to-Branch_B</a>

Page 1 of 1 Show 50 items Displaying 1 - 1 of 1

### Spoke\_Branch\_B > CONFIGURATION > VPN > IPsec VPN > VPN Connection

IPv4 Configuration				
#	Status	Name	VPN Gateway	Policy
1		Spoke_Branch_B	Spoke_Branch_B	<a href="#">Branch_B/HQ-to-Branch_A</a>

Page 1 of 1 Show 50 items Displaying 1 - 1 of 1

Go to ZyWALL/USG **MONITOR > VPN Monitor > IPSec** and verify the tunnel **Up Time** and the **Inbound(Bytes)/Outbound(Bytes)** traffic. Click **Connectivity Check** to verify the result of ICMP Connectivity.

### Hub\_HQ > MONITOR > VPN Monitor > IPSec > Hub\_HQ-to-Branch\_A

#	Name	Policy	My Address	Secure Gat...	Up Time	Timeout	Inbou...	Outb...
1	Hub_HQ-to-Branch_A	192.168.168.0-192.168.169.0<>192.168.167.0/24	172.16.10.1	P: 172.16.20.1	584	85836	0(0 by...	0(0 by...
2	Hub_HQ-to-Branch_B	192.168.167.0-192.168.168.0<>192.168.169.0/24	172.16.10.1	P: 172.16.30.1	23	86397	0(0 by...	0(0 by...

Page 1 of 1 Show 50 items Displaying 1 - 2 of 2

**Connectivity Check**

Connectivity Check

IP Address:

OK Cancel

**Result**

 ICMP Connectivity Check PASS on Hub\_HQ-to-Branch\_A

OK

### Hub\_HQ > MONITOR > VPN Monitor > IPSec > Hub\_HQ-to-Branch\_B

#	Name	Policy	My Address	Secure Gat...	Up Time	Timeout	Inbou...	Outb...
1	Hub_HQ-to-Branch_A	192.168.168.0-192.168.169.0<>192.168.167.0/24	172.16.10.1	P: 172.16.20.1	584	85836	0(0 by...	0(0 by...
2	Hub_HQ-to-Branch_B	192.168.167.0-192.168.168.0<>192.168.169.0/24	172.16.10.1	P: 172.16.30.1	23	86397	0(0 by...	0(0 by...

Page 1 of 1 Show 50 items Displaying 1 - 2 of 2

**Connectivity Check**

Connectivity Check

IP Address:

OK Cancel



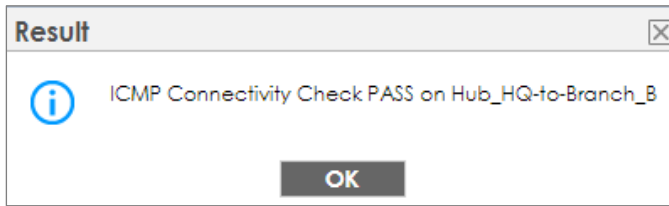

## Spoke\_Branch\_A > MONITOR > VPN Monitor > IPSec

#	Name	Policy	My Address	Secure Gateway	Up Time	Timeout	Inbou...	Outb...
1	Spoke_Branch_A	192.168.167.0/24<>192.168.168.0-192.168.169.0	172.16.20.1	P: 172.16.10.1	30	73410	0(0 by...	0(0 by...

Page 1 of 1 | Show 50 items | Displaying 1 - 1 of 1

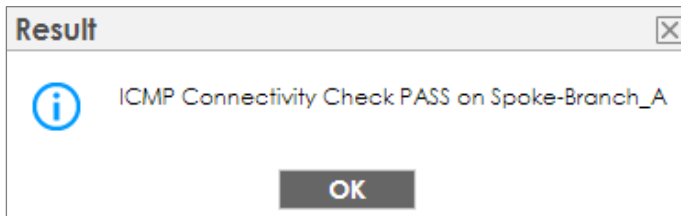
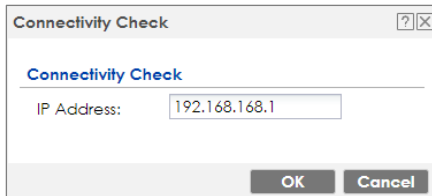

## Spoke\_Branch\_B > MONITOR > VPN Monitor > IPSec

#	Name	Policy	My Address	Secure Gatew...	Up Ti...	Time...	Inbo...	Outb...
1	Spoke_Branch_B	192.168.169.0/24<>192.168.167.0-192.168.168.0	172.16.30.1	P: 172.16.10.1	115	86305	0(0 b...	0(0 b...

Page 1 of 1 | Show 50 items | Displaying 1 - 1 of 1

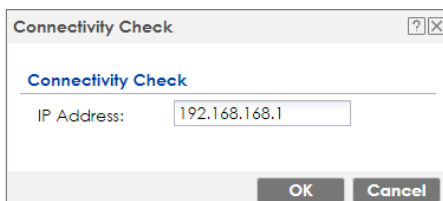

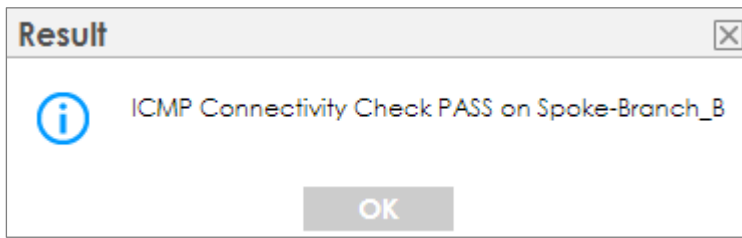

## What Could Go Wrong?

If you see [info] or [error] log message such as below, please check ZyWALL/USG Phase 1 Settings. All ZyWALL/USG units must use the same Pre-Shared Key, Encryption, Authentication method, DH key group and ID Type to establish the IKE SA.

Priority	Category	Message	Note
info	IKE	Recv:[NOTIFY:INVALID_COOKIE]	IKE_LOG
info	IKE	Send:[ID][HASH][NOTIFY:INITIAL_CONTACT]	IKE_LOG
Priority	Category	Message	Note
error	IPSec	SPI: 0x0 (0) SEQ: 0x0 (0) No rule found, Dropping TCP packet	IPSec
error	IPSec	SPI: 0x0 (0) SEQ: 0x0 (0) No rule found, Dropping TCP packet	IPSec
info	IKE	[COOKIE] Invalid cookie, no sa found	IKE_LOG
Priority	Category	Message	Note
info	IKE	Recv:[HASH][NOTIFY:NO_PROPOSAL_CHOSEN]	IKE_LOG

If you see that Phase 1 IKE SA process done but still get [info] log message as below, please check ZyWALL/USG and SonicWALL Phase 2 Settings. All ZyWALL/USG units must use the same Protocol, Encapsulation, Encryption, Authentication method and PFS to establish the IKE SA.

19	2017-09-11 ...	info	IKE	[SA] : No proposal chosen	IKE_LOG
20	2017-09-11 ...	info	IKE	[ID] : Tunnel [Server] Phase 2 Local policy mismatch	IKE_LOG
31	2017-09-11 ...	info	IKE	Send:[HASH][SA][NONCE][ID][D]	IKE_LOG
32	2017-09-11 ...	info	IKE	Phase 1 IKE SA process done	IKE_LOG

Make sure the all ZyWALL/USG units' security policies allow IPSec VPN traffic. IKE uses UDP port 500, AH uses IP protocol 51, and ESP uses IP protocol 50.

By default, NAT traversal is enabled on ZyWALL/USG, so please make sure the remote IPSec device also has NAT traversal enabled.

## How to Use Dual-WAN to Perform Fail-Over on VPN Using the VPN Concentrator

This is an example of using Dual-WAN to perform fail-over on a hub-and-spoke VPN with the HQ ZyWALL/USG as the hub and spoke VPNs to Branches A and B. When the VPN tunnel is configured, traffic passes between branches via the hub (HQ). Traffic can also pass between spoke-and-spoke through the hub. If the primary WAN interface is unavailable, the backup WAN interface will be used. When the primary WAN interface is available again, traffic will use that interface again.

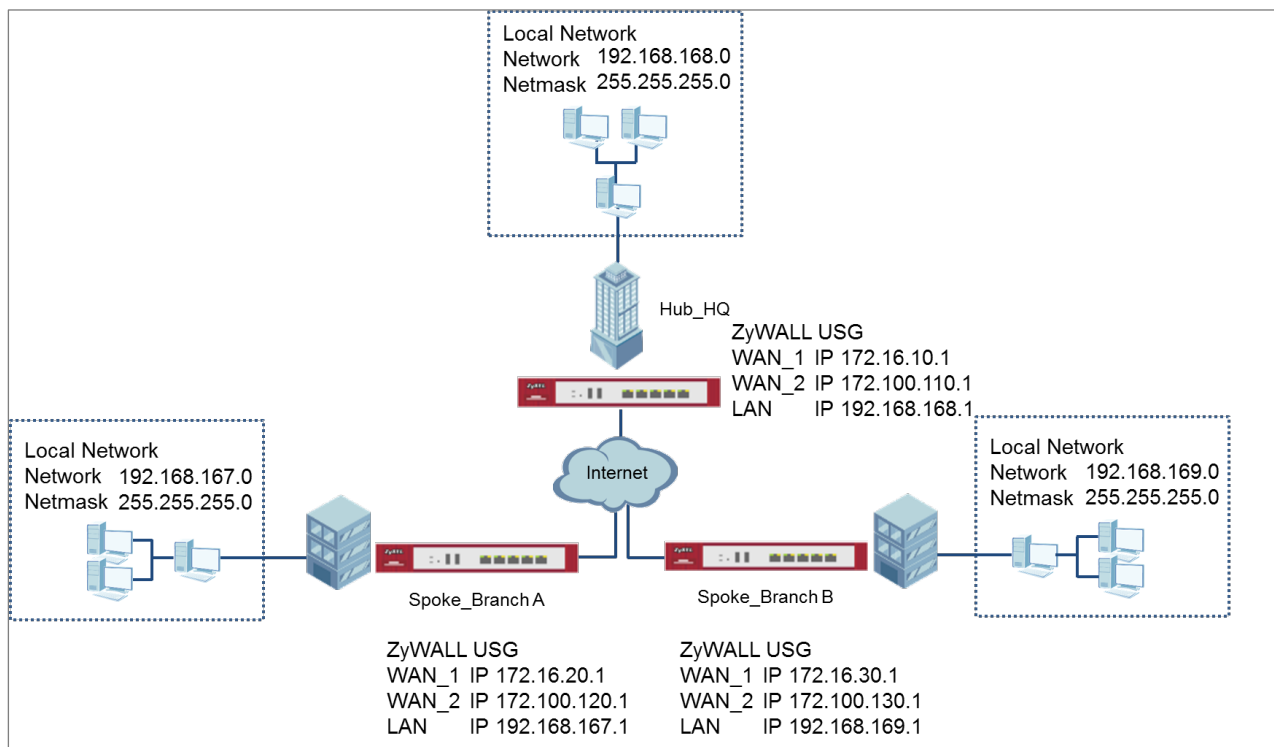

Hub & Spoken VPN Using the VPN Concentrator with Backup

**WAN**

 Note: All network IP addresses and subnet masks are used as examples in this article. Please replace them with your actual network IP addresses and subnet masks. This example was tested using USG310 (Firmware Version: ZLD 4.25).

## Set Up the IPsec VPN Tunnel on the ZyWALL/USG Hub\_HQ-to-Branch\_A

Go to **CONFIGURATION > VPN > IPsec VPN > VPN Gateway**, select **Enable**. Type the **VPN Gateway Name** used to identify this VPN gateway.

Then, configure the **Primary** Gateway IP as the **Branch A's wan1** IP address (in the example, 172.16.20.1) and **Secondary** Gateway IP as the **Branch A's wan2** IP address (in the example, 172.100.120.1). Select **Fall back to Primary Peer Gateway when possible** and set desired **Fall Back Check Interval** time.

Type a secure **Pre-Shared Key** (8-32 characters) which must match your **Branch A's** Pre-Shared Key and click **OK**.

### CONFIGURATION > VPN > IPsec VPN > VPN Gateway

**General Settings**

**Enable**

VPN Gateway Name:

**IKE Version**

IKEv1

IKEv2

---

**Gateway Settings**

**My Address**

Interface  DHCP client -- 172.16.10.1/255.255.255.

Domain Name / IPv4

**Peer Gateway Address**

Static Address i

Primary

Secondary

**Fall back to Primary Peer Gateway when possible**

Fall Back Check Interval:  (60-86400 seconds)

Dynamic Address i

**Authentication**

Pre-Shared Key .....  
 unmasked

Certificate default (See [My Certificates](#))

User Based PSK admin ⓘ

Advance

---

**Phase 1 Settings**

SA Life Time: 86400 (180 - 3000000 Seconds)

Negotiation Mode: Main

Advance

Go to **CONFIGURATION > VPN > IPSec VPN > VPN Connection** and select **Enable**. Type the **Connection Name** used to identify this VPN connection. Select scenario as **Site-to-site** and VPN Gateway which is configured in Step 1.

**CONFIGURATION > VPN > IPSec VPN > VPN Connection > General Settings and VPN Gateway**

**General Settings**

Enable

Connection Name: Hub\_HQ-to-Branch\_A

Advance

---

**VPN Gateway**

Application Scenario

Site-to-site  
 Site-to-site with Dynamic Peer  
 Remote Access (Server Role)  
 Remote Access (Client Role)  
 Vpn Tunnel Interface

VPN Gateway: Hub\_HQ-to-Branch\_A ge2 172.16.20.1, 172.100.120.1

Click **Create new Object** to add the address of local network behind **Hub\_HQ** and an address of local network behind **Branch A**.

**CONFIGURATION > VPN > IPSec VPN > VPN Connection > Create new Object**

### Local Policy

Name:   
 Address Type:   
 Network:   
 Netmask:

### Remote Policy

Name:   
 Address Type:   
 Network:   
 Netmask:

Set **Local Policy** to be **Hub\_HQ** and **Remote Policy** to **Branch\_A** which are newly created. Click **OK**.

**CONFIGURATION > VPN > IPSec VPN > VPN Connection > Policy**

Policy	
Local policy:	<input type="text" value="Hub_HQ"/> SUBNET, 192.168.168.0/24
Remote policy:	<input type="text" value="Spock_Branch_A_L"/> SUBNET, 192.168.167.0/24
<input type="checkbox"/> Advance	
Phase 2 Setting	
SA Life Time:	<input type="text" value="86400"/> (180 - 3000000 Seconds)
<input type="checkbox"/> Advance	
Related Settings	
Zone:	<input type="text" value="IPSec_VPN"/> <input type="button" value="Info"/>

## Hub\_HQ-to-Branch\_B

Go to **CONFIGURATION > VPN > IPSec VPN > VPN Gateway**, select **Enable**. Type the **VPN Gateway Name** used to identify this VPN gateway.

Then, configure the **Primary** Gateway IP as the **Branch B's wan1** IP address (in the example, 172.16.30.1) and **Secondary** Gateway IP as the **Branch B's wan2** IP address (in the example, 172.100.130.1). Select **Fall back to Primary Peer Gateway when possible** and set desired **Fall Back Check Interval** time.

Type a secure **Pre-Shared Key** (8-32 characters) which must match your **Branch A's** Pre-Shared Key and click **OK**.

### CONFIGURATION > VPN > IPSec VPN > VPN Gateway

**General Settings**

Enable

VPN Gateway Name:

**IKE Version**

IKEv1

IKEv2

---

**Gateway Settings**

**My Address**

Interface  DHCP client -- 172.16.10.1/255.255.255.

Domain Name / IPv4

**Peer Gateway Address**

Static Address i

Primary

Secondary

Fall back to Primary Peer Gateway when possible

Fall Back Check Interval:  (60-86400 seconds)



### Authentication

Pre-Shared Key   
 unmasked

Certificate  (See [My Certificates](#))

User Based PSK

Advance

### Phase 1 Settings

SA Life Time:  (180 - 3000000 Seconds)

Negotiation Mode:

Advance

Go to **CONFIGURATION > VPN > IPSec VPN > VPN Connection** to enable VPN Connection. Select scenario as **Site-to-site** and VPN Gateway which is configured in Step 1.

### CONFIGURATION > VPN > IPSec VPN > VPN Connection > General Settings and VPN Gateway

### General Settings

Enable

Connection Name:

Advance

### VPN Gateway

Application Scenario

Site-to-site

Site-to-site with Dynamic Peer

Remote Access (Server Role)

Remote Access (Client Role)

Vpn Tunnel Interface

VPN Gateway:  ge2 172.16.30.1, 172.100.130.1

Click **Create new Object** to add an address of local network behind **Hub\_HQ** and an address of local network behind **Branch B**.

**CONFIGURATION > VPN > IPSec VPN > VPN Connection > Create new Object**

### Local Policy

**Add Address Rule**

Name: Hub\_HQ

Address Type: SUBNET

Network: 192.168.168.0

Netmask: 255.255.255.0

OK Cancel

### Remote Policy

**Add Address Rule**

Name: Spoke\_Branch\_B\_LO...

Address Type: SUBNET

Network: 192.168.169.0

Netmask: 255.255.255.0

OK Cancel

Set **Local Policy** to be **Hub\_HQ** and **Remote Policy** to **Branch\_B** which are newly created. Click **OK**.

**CONFIGURATION > VPN > IPSec VPN > VPN Connection > Policy**

**Policy**

Local policy: Hub\_HQ SUBNET, 192.168.168.0/24

Remote policy: Spoke\_Branch\_B\_L... SUBNET, 192.168.169.0/24

Advance

**Phase 2 Setting**

SA Life Time: 86400 (180 - 3000000 Seconds)

Advance

**Related Settings**

Zone: IPSec\_VPN

## Hub\_HQ Concentrator

In the ZyWALL/USG, go to **CONFIGURATION > VPN > IPSec VPN > Concentrator**, add a VPN Concentrator rule. Select VPN tunnels to the same member group and click **Save**.

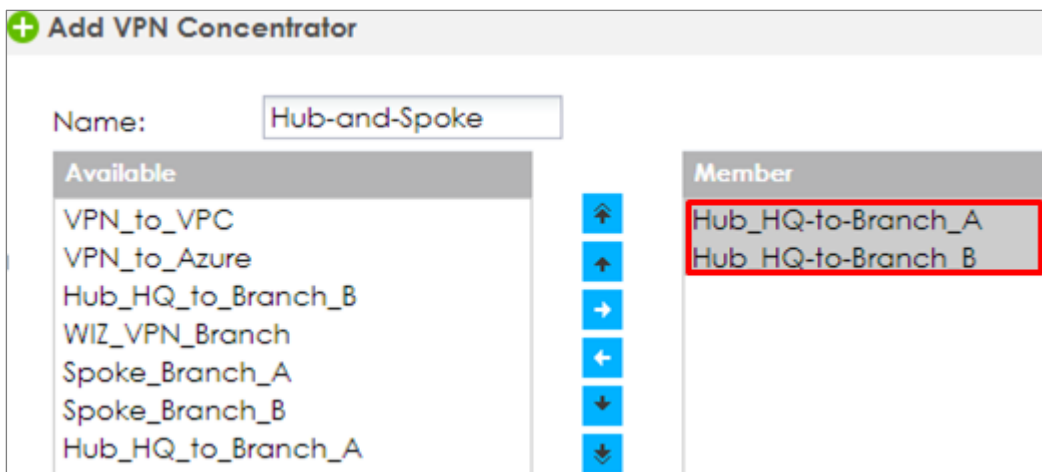
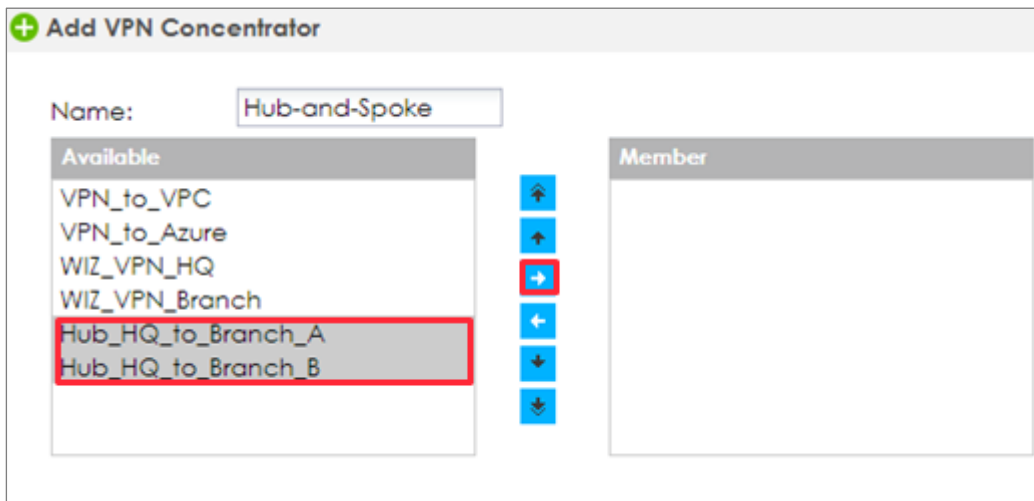

## Spoke\_Branch\_A

Go to **CONFIGURATION > VPN > IPsec VPN > VPN Gateway**, select **Enable**. Type the **VPN Gateway Name** used to identify this VPN gateway.

Then, configure the **Primary** Gateway IP as the **Hub\_HQ's wan1** IP address (in the example, 172.16.10.1) and **Secondary** Gateway IP as the **Hub\_HQ's wan2** IP address (in the example, 172.100.110.1). Select **Fall back to Primary Peer Gateway when possible** and set desired **Fall Back Check Interval** time.

Type a secure **Pre-Shared Key** (8-32 characters) which must match your **Hub\_HQ's** Pre-Shared Key and click **OK**.

### CONFIGURATION > VPN > IPsec VPN > VPN Gateway

#### General Settings

Enable

VPN Gateway Name:

#### IKE Version

IKEv1  
 IKEv2

#### Gateway Settings

##### My Address

Interface  DHCP client -- 172.16.20.1/255.255.255.  
 Domain Name / IPv4

##### Peer Gateway Address

Static Address i

Primary   
Secondary

Fall back to Primary Peer Gateway when possible

Fall Back Check Interval:  (60-86400 seconds)

Dynamic Address i

**Authentication**

Pre-Shared Key   unmasked

Certificate  (See [My Certificates](#))

User Based PSK  ⓘ

Advance

---

**Phase 1 Settings**

SA Life Time:  (180 - 3000000 Seconds)

Negotiation Mode:

Advance

Go to **CONFIGURATION > VPN > IPSec VPN > VPN Connection** and select **Enable**. Type the **Connection Name** used to identify this VPN connection. Select scenario as **Site-to-site** and VPN Gateway which is configured in Step 1.

### CONFIGURATION > VPN > IPSec VPN > VPN Connection > General Settings and VPN Gateway

**General Settings**

Enable

Connection Name:

Advance

---

**VPN Gateway**

Application Scenario

Site-to-site

Site-to-site with Dynamic Peer

Remote Access (Server Role)

Remote Access (Client Role)

Vpn Tunnel Interface

VPN Gateway:  ge2 172.16.10.1, 172.100.110.1

Click **Create new Object** to add the address of local network behind **Branch A** and an address of local network behind **Hub\_HQ**

**CONFIGURATION > VPN > IPSec VPN > VPN Connection > Create new Object**

### Local Policy

The screenshot shows a dialog box titled "Add Address Rule" with the following fields: Name: Spoke\_Branch\_A\_LOCAL, Address Type: SUBNET, Network: 192.168.167.0, and Netmask: 255.255.255.0. There are OK and Cancel buttons at the bottom.

### Remote Policy

The screenshot shows a dialog box titled "Add Address Rule" with the following fields: Name: Hub\_HQ, Address Type: SUBNET, Network: 192.168.168.0, and Netmask: 255.255.255.0. There are OK and Cancel buttons at the bottom.

Set **Local Policy** to be **Spoke\_Branch\_A\_LOCAL** and **Remote Policy** to **Hub\_HQ** which are newly created. Click **OK**.

**CONFIGURATION > VPN > IPSec VPN > VPN Connection > Policy**

The screenshot shows the "Policy" configuration page. Under "Local policy:", the dropdown menu is set to "Spoke\_Branch\_A\_L" and the address is "SUBNET, 192.168.167.0/24". Under "Remote policy:", the dropdown menu is set to "Hub\_HQ" and the address is "SUBNET, 192.168.168.0/24". There are "Advance" checkboxes for both. Under "Phase 2 Setting", "SA Life Time" is set to "86400" with a note "(180 - 3000000 Seconds)". There is another "Advance" checkbox. Under "Related Settings", the "Zone" is set to "IPSec\_VPN".

Go to **Network > Routing > Policy Route** to add a **Policy Route** to allow traffic from **Spoke\_Branch\_A** to **Spoke\_Branch\_B**.

Click **Create new Object** and set the address to be the local network behind the **Spoke\_Branch\_B**. Select **Source Address** to be the local network behind the **Spoke\_Branch\_A**. Then, scroll down the **Destination Address** list to choose the newly created **Spoke\_Branch\_B\_LOCAL** address. Click **OK**.

## Network > Routing > Policy Route

Criteria	
User:	any
Incoming:	any (Excluding ZyV)
Source Address:	Spoke_Branch_A_L
Destination Address:	Spoke_Branch_B_L
DSCP Code:	any
Schedule:	none
Service:	any
Next-Hop	
Type:	VPN Tunnel
VPN Tunnel:	Spoke_Branch_A

## Spoke\_Branch\_B

Go to **CONFIGURATION > VPN > IPSec VPN > VPN Gateway**, select **Enable**. Type the **VPN Gateway Name** used to identify this VPN gateway.

Then, configure the **Primary** Gateway IP as the **Hub\_HQ**'s **wan1** IP address (in the example, 172.16.10.1) and **Secondary** Gateway IP as the **Hub\_HQ**'s **wan2** IP

address (in the example, 172.100.110.1). Select **Fall back to Primary Peer Gateway when possible** and set desired **Fall Back Check Interval** time.

Type a secure **Pre-Shared Key** (8-32 characters) which must match your **Hub\_HQ's** Pre-Shared Key and click **OK**.

## CONFIGURATION > VPN > IPSec VPN > VPN Gateway

### General Settings

Enable

VPN Gateway Name:

**IKE Version**

IKEv1

IKEv2

### Gateway Settings

**My Address**

Interface  DHCP client -- 172.16.30.1/255.255.255.

Domain Name / IPv4

**Peer Gateway Address**

Static Address **i**

Primary

Secondary

Fall back to Primary Peer Gateway when possible

Fall Back Check Interval:  (60-86400 seconds)

Dynamic Address **i**

### Authentication

Pre-Shared Key   unmasked

Certificate  (See [My Certificates](#))

User Based PSK  **i**

Advance

### Phase 1 Settings

SA Life Time:  (180 - 3000000 Seconds)

Negotiation Mode:

Advance



Go to **CONFIGURATION > VPN > IPsec VPN > VPN Connection** and select **Enable**. Type the **Connection Name** used to identify this VPN connection. Select scenario as **Site-to-site** and VPN Gateway which is configured in Step 1.

## CONFIGURATION > VPN > IPsec VPN > VPN Connection > General Settings and VPN Gateway

The screenshot shows the configuration page for a VPN connection. Under the **General Settings** section, the **Enable** checkbox is checked, and the **Connection Name** is set to **Spoke\_Branch\_B**. The **Advance** checkbox is also checked. Under the **VPN Gateway** section, the **Application Scenario** is set to **Site-to-site**. The **VPN Gateway** dropdown menu is set to **Spoke\_Branch\_B**, and the associated IP addresses are **ge2 172.16.10.1, 172.100.110.1**.

Click **Create new Object** to add the address of local network behind **Branch B** and an address of local network behind **Hub\_HQ**.

## CONFIGURATION > VPN > IPsec VPN > VPN Connection > Create new Object Local Policy

The screenshot shows the **Add Address Rule** dialog box. The **Name** is **Spoke\_Branch\_B\_LOC**, the **Address Type** is **SUBNET**, the **Network** is **192.168.169.0**, and the **Netmask** is **255.255.255.0**. There are **OK** and **Cancel** buttons at the bottom.

## Remote Policy

The screenshot shows the **Add Address Rule** dialog box. The **Name** is **Hub\_HQ**, the **Address Type** is **SUBNET**, the **Network** is **192.168.168.0**, and the **Netmask** is **255.255.255.0**. There are **OK** and **Cancel** buttons at the bottom.

Set **Local Policy** to be **Spoke\_Branch\_B\_LOCAL** and **Remote Policy** to **Hub\_HQ** which are newly created. Click **OK**.

**CONFIGURATION > VPN > IPSec VPN > VPN Connection > Policy**

<b>Policy</b>		
Local policy:	Spoke_Branch_B_L	SUBNET, 192.168.169.0/24
Remote policy:	Hub_HQ	SUBNET, 192.168.168.0/24
<input type="checkbox"/> Advance		
<b>Phase 2 Setting</b>		
SA Life Time:	86400	(180 - 3000000 Seconds)
<input type="checkbox"/> Advance		
<b>Related Settings</b>		
Zone:	IPSec_VPN	

Go to **Network > Routing > Policy Route** to add a Policy Route to allow traffic from **Spoke\_Branch\_B** to **Spoke\_Branch\_A**.

Click **Create new Object** and set the address to be the local network behind the **Spoke\_Branch\_A**. Select **Source Address** to be the local network behind the **Spoke\_Branch\_B**. Then, scroll down the **Destination Address** list to choose the newly created **Spoke\_Branch\_A\_LOCAL** address. Click **OK**.

**Network > Routing > Policy Route**

<b>Criteria</b>	
User:	any
Incoming:	any (Excluding ZyV)
Source Address:	Spoke_Branch_B_L
Destination Address:	Spoke_Branch_A_L
DSCP Code:	any
Schedule:	none
Service:	any
<b>Next-Hop</b>	
Type:	VPN Tunnel
VPN Tunnel:	Spoke_Branch_B

## Test the IPsec VPN Tunnel

Go to ZyWALL/USG **CONFIGURATION > VPN > IPsec VPN > VPN Connection**, click **Connect** on the upper bar. The **Status** connect icon is lit when the interface is connected.

### Hub\_HQ > CONFIGURATION > VPN > IPsec VPN > VPN Connection

The screenshot shows the IPv4 Configuration page for Hub\_HQ. At the top, there are action buttons: Add, Edit, Remove, Activate, Inactivate, Connect, Disconnect, and Object References. Below is a table with columns: #, Status, Name, VPN Gateway, and Policy.

#	Status	Name	VPN Gateway	Policy
1		Hub_HQ-to-Branch_A	Hub_HQ-to-Branch_A	<a href="#">Hub_HQ/Spoke_Branch_A_LOCAL</a>
2		Hub_HQ-to-Branch_B	Hub_HQ-to-Branch_B	<a href="#">Hub_HQ/Spoke_Branch_B_LOCAL</a>

At the bottom, there is a pagination bar: Page 1 of 1, Show 50 items, and Displaying 1 - 2 of 2.

### Spoke\_Branch\_A > CONFIGURATION > VPN > IPsec VPN > VPN Connection

The screenshot shows the IPv4 Configuration page for Spoke\_Branch\_A. At the top, there are action buttons: Add, Edit, Remove, Activate, Inactivate, Connect, Disconnect, and Object References. Below is a table with columns: #, Status, Name, VPN Gateway, and Policy.

#	Status	Name	VPN Gateway	Policy
1		Spoke-Branch_A	Spoke-Branch_A	<a href="#">Spoke-Branch_A_LOCAL/Hub_HQ</a>

At the bottom, there is a pagination bar: Page 1 of 1, Show 50 items, and Displaying 1 - 1 of 1.

### Spoke\_Branch\_B > CONFIGURATION > VPN > IPsec VPN > VPN Connection

The screenshot shows the IPv4 Configuration page for Spoke\_Branch\_B. At the top, there are action buttons: Add, Edit, Remove, Activate, Inactivate, Connect, Disconnect, and Object References. Below is a table with columns: #, Status, Name, VPN Gateway, and Policy.

#	Status	Name	VPN Gateway	Policy
1		Spoke-Branch_B	Spoke-Branch_B	<a href="#">Spoke-Branch_B_LOCAL/Hub_HQ</a>

At the bottom, there is a pagination bar: Page 1 of 1, Show 50 items, and Displaying 1 - 1 of 1.

Go to ZyWALL/USG **MONITOR > VPN Monitor > IPSec** and verify the tunnel **Up Time** and the **Inbound(Bytes)/Outbound(Bytes)** traffic. Click **Connectivity Check** to verify the result of ICMP Connectivity.

### Hub\_HQ > MONITOR > VPN Monitor > IPSec > Hub\_HQ-to-Branch\_A

#	Name	Policy	My Addr...	Secure Gatew...	Up Time	Timeout	Inbound{...	Outbound...
1	Hub_HQ-to-Branch_A	192.168.168.0/24<>192.168.167.0/24	172.16.10.1	P: 172.16.20.1	690	85730	1(46 bytes)	1(60 bytes)
2	Hub_HQ-to-Branch_B	192.168.168.0/24<>192.168.169.0/24	172.16.10.1	P: 172.16.30.1	505	85915	1(78 bytes)	0(0 bytes)

Page 1 of 1 Show 50 items Displaying 1 - 2 of 2

**Connectivity Check**

Connectivity Check

IP Address:

OK Cancel

**Result**

 ICMP Connectivity Check PASS on Hub\_HQ-to-Branch\_A

OK

### Hub\_HQ > MONITOR > VPN Monitor > IPSec > Hub\_HQ-to-Branch\_B

#	Name	Policy	My Addr...	Secure Gatew...	Up Time	Timeout	Inbound{...	Outbound...
1	Hub_HQ-to-Branch_A	192.168.168.0/24<>192.168.167.0/24	172.16.10.1	P: 172.16.20.1	690	85730	1(46 bytes)	1(60 bytes)
2	Hub_HQ-to-Branch_B	192.168.168.0/24<>192.168.169.0/24	172.16.10.1	P: 172.16.30.1	505	85915	1(78 bytes)	0(0 bytes)

Page 1 of 1 Show 50 items Displaying 1 - 2 of 2

**Connectivity Check**

Connectivity Check

IP Address:

OK Cancel

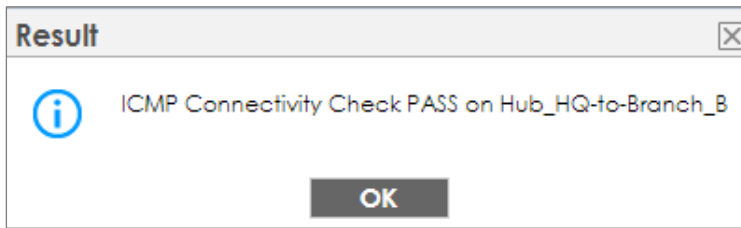

Spoke\_Branch\_A > MONITOR > VPN Monitor > IPsec

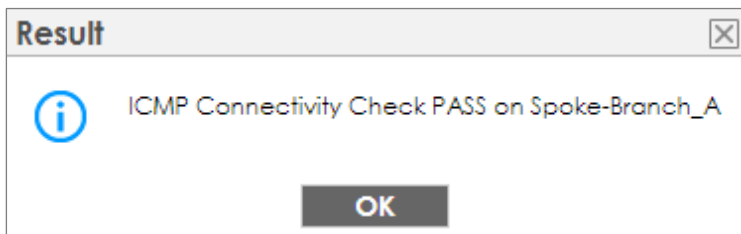

Spoke\_Branch\_B > MONITOR > VPN Monitor > IPsec

#	Name	Policy	My Address	Secure Ga...	Up Time	Timeout	Inbound(B...	Outbound(...
1	Spoke_Branch_B	192.168.169.0/24<->192.168.168.0/24	172.16.30.1	P: 172.16.10.1	4	73436	0(0 bytes)	0(0 bytes)

Page 1 of 1 | Show 50 items | Displaying 1 - 1 of 1

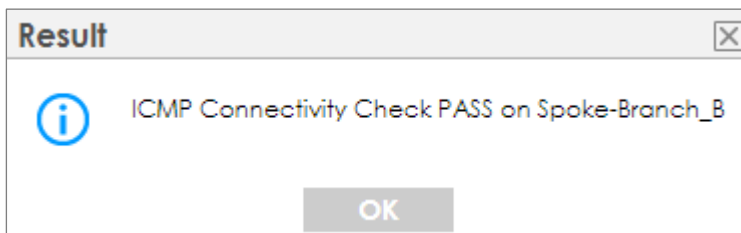
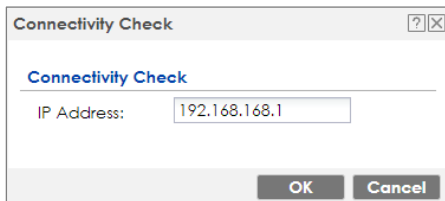

## What Could Go Wrong?

If you see [info] or [error] log message such as below, please check ZyWALL/USG Phase 1 Settings. All ZyWALL/USG units must use the same Pre-Shared Key, Encryption, Authentication method, DH key group and ID Type to establish the IKE SA.

Priority	Category	Message	Note
info	IKE	Recv:[NOTIFY:INVALID_COOKIE]	IKE_LOG
info	IKE	Send:[ID][HASH][NOTIFY:INITIAL_CONTACT]	IKE_LOG
Priority	Category	Message	Note
error	IPSec	SPI: 0x0 (0) SEQ: 0x0 (0) No rule found, Dropping TCP packet	IPSec
error	IPSec	SPI: 0x0 (0) SEQ: 0x0 (0) No rule found, Dropping TCP packet	IPSec
info	IKE	[COOKIE] Invalid cookie, no sa found	IKE_LOG
Priority	Category	Message	Note
info	IKE	Recv:[HASH][NOTIFY:NO_PROPOSAL_CHOSEN]	IKE_LOG

If you see that Phase 1 IKE SA process done but still get [info] log message as below, please check ZyWALL/USG Phase 2 Settings. All ZyWALL/USG units must use the same Protocol, Encapsulation, Encryption, Authentication method and PFS to establish the IKE SA.

19	2017-09-11 ...	info	IKE	[SA] : No proposal chosen	IKE_LOG
20	2017-09-11 ...	info	IKE	[ID] : Tunnel [Server] Phase 2 Local policy mismatch	IKE_LOG
31	2017-09-11 ...	info	IKE	Send:[HASH][SA][NONCE][ID][ID]	IKE_LOG
32	2017-09-11 ...	info	IKE	Phase 1 IKE SA process done	IKE_LOG

Make sure the all ZyWALL/USG units' security policies allow IPSec VPN traffic. IKE uses UDP port 500, AH uses IP protocol 51, and ESP uses IP protocol 50.

By default, NAT traversal is enabled on ZyWALL/USG, so please make sure the remote IPSec device also has NAT traversal enabled.

## How to Configure IPsec VPN with ZyWALL IPsec VPN Client

This example shows how to use the VPN Setup Wizard to create a site-to-site VPN between a ZyWALL/USG and a ZyWALL IPsec VPN Client. The example instructs how to configure the VPN tunnel between each site. When the VPN tunnel is configured, each site can be accessed securely.

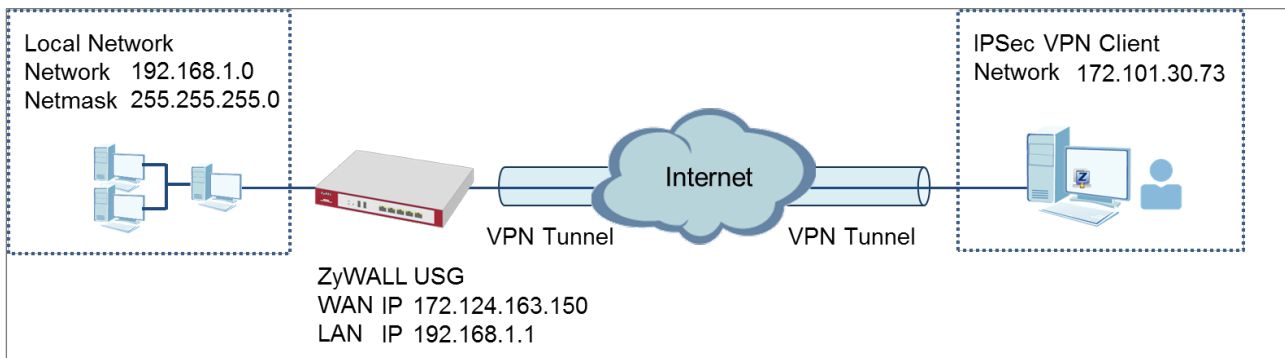

 Note: All network IP addresses and subnet masks are used as examples in this article. Please replace them with your actual network IP addresses and subnet masks. This example was tested using USG310 (Firmware Version: ZLD 4.25) and ZyWALL IPsec VPN

ZyWALL IPsec VPN Client with VPN Tunnel Connected

## Set Up the ZyWALL/USG IPSec VPN Tunnel

In the ZyWALL/USG, go to **Quick Setup > VPN Setup Wizard**, use the **VPN Settings for Configuration Provisioning** wizard to create a VPN rule that can be used with the ZyWALL IPSec VPN Client. Click **Next**.

### Quick Setup > VPN Setup Wizard > Welcome

**VPN Setup Wizard**

Wizard Type > VPN Settings > Wizard Completed  
1 2 3

**Welcome**

- VPN Settings
  - Wizard Type
  - VPN Settings
  - Wizard Completed
- VPN Settings for Configuration Provisioning**
  - Wizard Type
  - VPN Settings
  - Wizard Completed
- VPN Settings for L2TP VPN Settings
  - VPN Settings
  - General Settings
  - Wizard Completed

Choose **Express** to create a VPN rule with the default phase 1 and phase 2 settings and use a pre-shared key to be the authentication method. Click **Next**.

### Quick Setup > VPN Setup Wizard > Wizard Type

**VPN Setup Wizard**

Wizard Type > VPN Settings > Wizard Completed  
1 2 3

Please select the type of VPN policy you wish to setup.

**Type of VPN policy**

- Express**
- Advanced



Type the **Rule Name** used to identify this VPN connection (and VPN gateway). You may use 1-31 alphanumeric characters. This value is case-sensitive. Click **Next**.

### Quick Setup > VPN Setup Wizard > Welcome > Wizard Type > VPN Settings-1

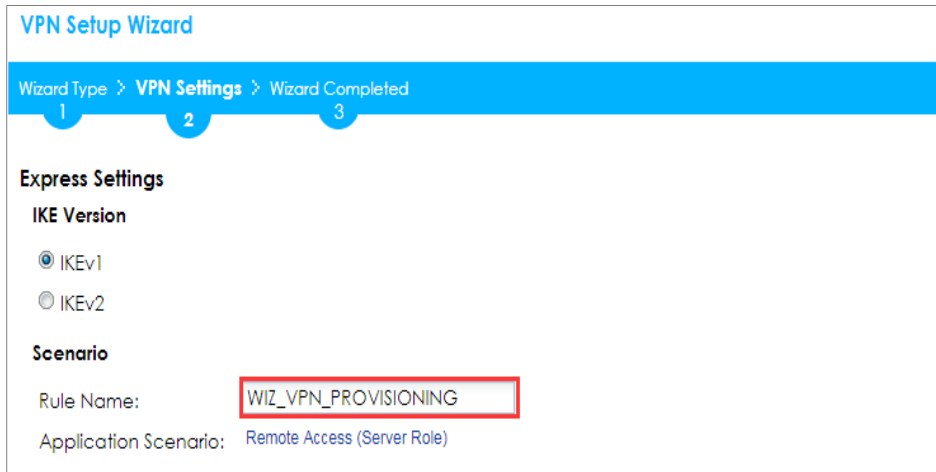

The screenshot shows the 'VPN Setup Wizard' interface. At the top, a blue breadcrumb trail reads 'Wizard Type > VPN Settings > Wizard Completed'. Below this, three numbered steps (1, 2, 3) are shown, with step 2 'VPN Settings' being the active step. The main content area is titled 'Express Settings' and contains two sections: 'IKE Version' with radio buttons for 'IKEv1' (selected) and 'IKEv2'; and 'Scenario' with a 'Rule Name' field containing 'WIZ\_VPN\_PROVISIONING' and an 'Application Scenario' dropdown set to 'Remote Access (Server Role)'. The 'Rule Name' field is highlighted with a red box.

Type a secure **Pre-Shared Key** (8-32 characters). Set **Local Policy** to be the IP address range of the network connected to the ZyWALL/USG.

### Quick Setup > VPN Setup Wizard > Welcome > Wizard Type > VPN Settings-2



The screenshot shows the 'VPN Setup Wizard' interface at step 2. The breadcrumb trail is 'Wizard Type > VPN Settings > Wizard Completed'. Step 2 'VPN Settings' is active. The main content area is titled 'Express Settings' and contains a 'Configuration' section with the following fields: 'Secure Gateway' set to 'Any'; 'Pre-Shared Key' set to 'zyx12345'; 'Local Policy (IP/Mask)' set to '192.168.1.33 / 255.255.255.0'; and 'Remote Policy (IP/Mask)' set to 'Any'. The 'Pre-Shared Key' and 'Local Policy' fields are highlighted with red boxes.

This screen provides a read-only summary of the VPN tunnel. Click **Save**.

**Quick Setup > VPN Setup Wizard > Welcome > Wizard Type > VPN Settings-3**

**VPN Setup Wizard**

Wizard Type > VPN Settings > Wizard Completed

1 2 3

**Express Settings**

**Summary**

Rule Name: WIZ\_VPN\_PROVISIONING

Secure Gateway: Any

Pre-Shared Key: zyx12345

Local Policy (IP/Mask): 192.168.1.0 / 255.255.255.0

Remote Policy (IP/Mask): Any

Now the rule is configured on the ZyWALL/USG. The Phase 1 rule settings appear in the **VPN > IPSec VPN > VPN Gateway** screen and the Phase 2 rule settings appear in the **VPN > IPSec VPN > VPN Connection** screen. Click **Close** to exit the wizard.

**Quick Setup > VPN Setup Wizard > Welcome > Wizard Type > VPN Settings > Wizard Completed**

**VPN Setup Wizard**

Wizard Type > VPN Settings > Wizard Completed

1 2 3

**Express Settings**

Congratulations. The VPN Access wizard is completed

**Summary**

Rule Name: WIZ\_VPN\_PROVISIONING

Secure Gateway: Any

Pre-Shared Key: zyx12345

Local Policy (IP/Mask): 192.168.1.0 / 255.255.255.0

Remote Policy (IP/Mask): Any

Go to **CONFIGURATION > Object > User/Group > Add A User** and create a user account for the ZyWALL IPSec VPN Client user.

**CONFIGURATION > Object > User/Group > Add A User**

**User Configuration**

User Name :

User Type:

Password:

Retype:

Description:

Authentication Timeout Settings  Use Default Settings  Use Manual Settings

Lease Time: 1440 minutes

Reauthentication Time: 1440 minutes

Go to **CONFIGURATION > VPN > IPSec VPN > Configuration Provisioning**. In the **General Settings** section, select the **Enable Configuration Provisioning**. Then, go to the **Configuration** section and click **Add** to bind a configured **VPN Connection** to **Allowed User**. Click **Activate** and **Apply** to save the configuration.

### CONFIGURATION > VPN > IPSec VPN > Configuration Provisioning

**General Settings**

Enable Configuration Provisioning

**Authentication**

Client Authentication Method:

**Configuration**

#	Status	Priority	Type	VPN Connection	Allowed User
1		1	4in4	WIZ_VPN_PROVISIONING	Remote_Client

Page 1 of 1 | Show 50 items | Displaying 1 - 1 of 1

## Set Up the ZyWALL IPSec VPN Client

Download **ZyWALL IPSec VPN Client** software from ZyXEL Download Library:

[http://www.zyxel.com/support/download\\_landing.shtml](http://www.zyxel.com/support/download_landing.shtml)

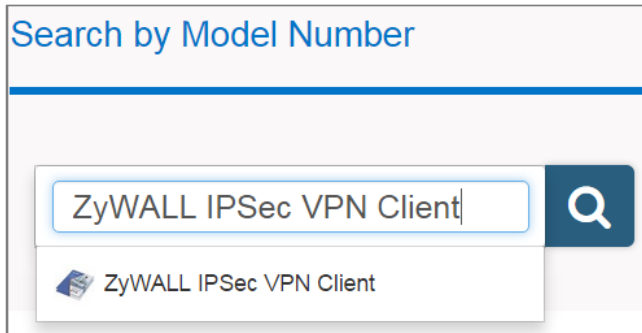

Open ZyWALL IPSec VPN Client, select **CONFIGURATION > Get from Server**.

### CONFIGURATION > Get from Server

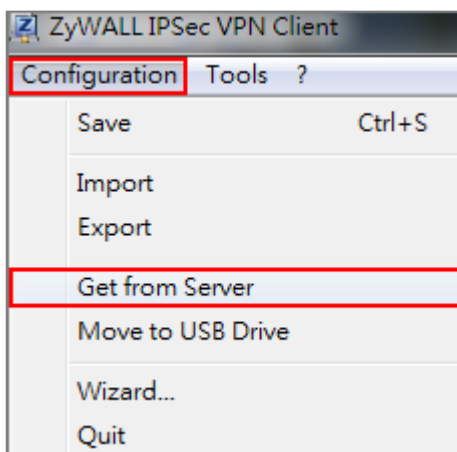

Enter the WAN IP address or URL for the ZyWALL/USG in the **Gateway Address**. If you changed the default HTTPS **Port** on the ZyWALL/USG, and then enter the new one here. Enter the **Login** user name and **Password** exactly as configured on the ZyWALL or external authentication server. Click **Next**, you will see it's processing VPN configuration from the server.

## CONFIGURATION > Get from Server > Step 1: Authentication

VPN Configuration Server Wizard

### Step 1: Authentication

What are the parameters of the VPN Server Connection?

You are going to download your VPN Configuration from the VPN Configuration Server.  
Enter below the authentication information required for the connection to the server.

Gateway Address: 172.124.163.150 Port: 443

Authentication: Login + Password

Login: Remote\_Client

Password: ●●●●●●

Next > Cancel

## CONFIGURATION > Get from Server > Step 2: Processing

VPN Configuration Server Wizard

### Step 2: Processing...

Requesting the VPN Configuration.

Downloading the VPN Configuration from the server:

Progress bar: [Green bar]

- ✓ Init Ok.
- ✓ Init crx server (172.124.163.150) Ok.
- Send https request...

Receive Config. from Server...  
Write Config. file...  
Apply Config. file...

< Previous Cancel

Then, you will see the **Configuration successful** page, click **OK** to exit the wizard.

**CONFIGURATION > Get from Server > Configuration successful**

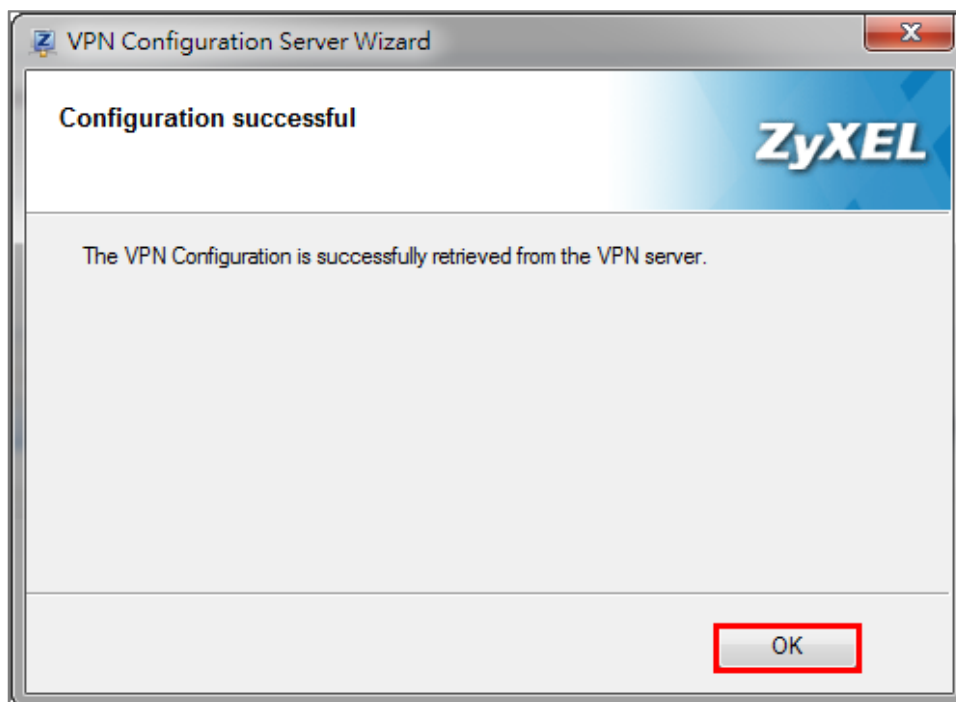

Go to **VPN Configuration > IKEv1**, right click the **WIZ\_VPN\_PROVISIONING** and select **Open tunnel**. You will see the **Tunnel opened** on the bottom right of the screen.

**VPN CONFIGURATION > IKE V1 > WIZ\_VPN\_PROVISIONING > Open tunnel**

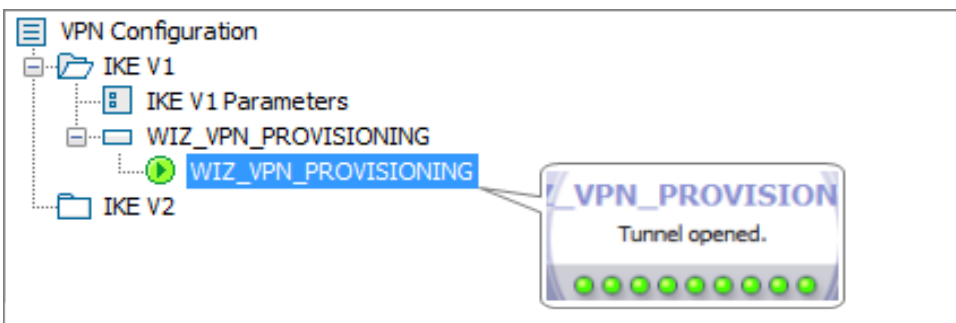
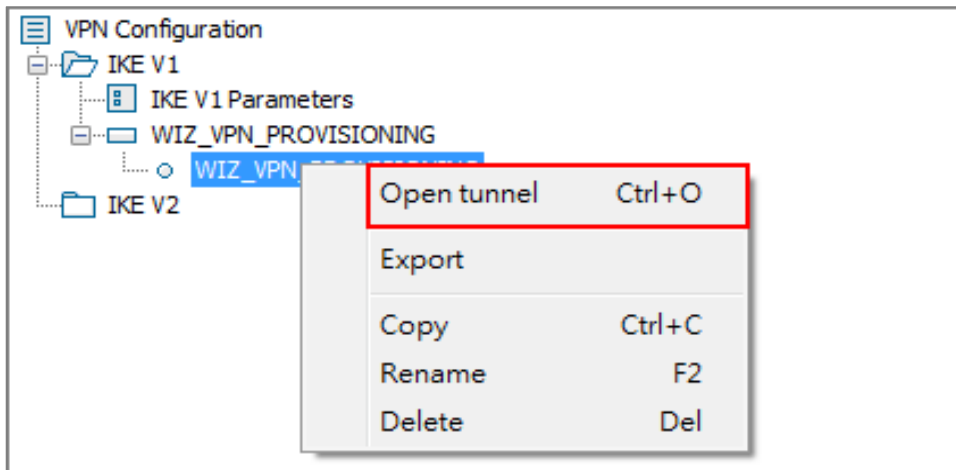

## Test the IPSec VPN Tunnel

Go to ZyWALL/USG **CONFIGURATION > VPN > IPSec VPN > VPN Connection**, the **Status** connect icon is lit when the interface is connected.

**CONFIGURATION > VPN > IPSec VPN > VPN Connection**



Go to ZyWALL/USG **MONITOR > VPN Monitor > IPSec** and verify the tunnel **Up Time** and **Inbound(Bytes)/Outbound(Bytes)** Traffic.

## MONITOR > VPN Monitor > IPSec

#	Sy.	Sy.	Name	Policy	My Address	Secure Gateway	Up Time	Timeout	Inbound(Bytes)	Outbound(Bytes)
1	N/A	N/A	WIZ_VPN_PROVISIONING	192.168.1.0/24<=>172.101.30.73	172.101.30.150	D:172.101.30.73	6	86414	21(1854 bytes)	0(0 bytes)

To test whether or not a tunnel is working, ping from a computer at one site to a computer at the other. Ensure that both computers have Internet access (via the IPSec devices).

**PC with ZyWALL IPSec VPN Client installed > Window 7 > cmd > ping 192.168.1.33**

```
C:\Documents and Settings\ZYXEL>ping 192.168.1.33

Pinging 192.168.1.33 with 32 bytes of data:

Reply from 192.168.1.33: bytes=32 time=27ms TTL=43
Reply from 192.168.1.33: bytes=32 time=32ms TTL=43
Reply from 192.168.1.33: bytes=32 time=26ms TTL=43
Reply from 192.168.1.33: bytes=32 time=27ms TTL=43

Ping statistics for 192.168.1.33:
    Packets: Sent = 4, Received = 4, Lost = 0 (0% loss),
    Approximate round trip times in milli-seconds:
        Minimum = 26ms, Maximum = 32ms, Average = 28ms
```

**PC behind ZyWALL/USG > Window 7 > cmd > ping 172.101.30.73**

```
C:\Documents and Settings\ZYXEL>ping 172.101.30.73

Pinging 172.101.30.73 with 32 bytes of data:

Reply from 172.101.30.73: bytes=32 time=18ms TTL=54
Reply from 172.101.30.73: bytes=32 time=17ms TTL=54
Reply from 172.101.30.73: bytes=32 time=17ms TTL=54
Reply from 172.101.30.73: bytes=32 time=16ms TTL=54

Ping statistics for 172.101.30.73:
    Packets: Sent = 4, Received = 4, Lost = 0 (0% loss),
    Approximate round trip times in milli-seconds:
        Minimum = 16ms, Maximum = 18ms, Average = 17ms
```



## What Can Go Wrong?

If you see [info] log message such as below, please make sure both ZyWALL/USG and ZyWALL IPSec VPN Client use the same **Pre-Shared Key** to establish the IKE SA.

### MONITOR > Log

Priority	Category	Message	Note
info	IKE	Send:[NOTIFY:INVALID_PAYLOAD_TYPE]	IKE_LOG
info	IKE	Invalid payload type in encrypted payload chain, possibly because of different pre-shared keys	IKE_LOG

If you see [info] or [error] log message such as below, please check ZyWALL/USG Phase 1 Settings. ZyWALL/USG and ZyWALL IPSec VPN Client must use the same Encryption, Authentication method, DH key group and ID Type/Content to establish the IKE SA.

### MONITOR > Log

info	IKE	[SA] : No proposal chosen	IKE_LOG
info	IKE	[SA] : Tunnel [WIZ_VPN_PROVISIONING] Phase 1 proposal mismatch	IKE_LOG

If you see that Phase 1 IKE SA process done but still get [alert] or [info] log message as below, please check ZyWALL/USG Phase 2 Settings. ZyWALL/USG and ZyWALL IPSec VPN Client must use the same Active Protocol, Encapsulation, Proposal, PFS and set correct Local Policy to establish the IKE SA.

### MONITOR > Log

info	IKE	[SA] : No proposal chosen	IKE_LOG
info	IKE	[SA] : Tunnel [WIZ_VPN_PROVISIONING] Phase 2 proposal mismatch	IKE_LOG

info	IKE	[SA] : No proposal chosen	IKE_LOG
info	IKE	[ID] : Tunnel [WIZ_VPN_PROVISIONING] Phase 2 Local policy mismatch	IKE_LOG

If you see [alert] log message as below, please make sure you create a user account for the ZyWALL IPSec VPN Client user on ZyWALL/USG or the external authentication server. Or please check your password matches the settings in the user account.

### MONITOR > Log

Priority	Cate...	Message	Note
alert	User	Failed login attempt to Device from http/https (incorrect password or inexistent username)	Account: Remote_Client

Make sure the service HTTPS **Port** on IPsec VPN Client application is available.

Make sure the To-ZyWALL security policies allow IPsec VPN traffic to the ZyWALL/USG. IKE uses UDP port 500, AH uses IP protocol 51, and ESP uses IP protocol 50.

The ZyWALL/USG supports UDP port 500 and UDP port 4500 for NAT traversal. If you enable this, make sure the To-ZyWALL security policies allow UDP port 4500 too.

## How to Configure Site-to-site IPSec VPN with FortiGate

This example shows how to use the VPN Setup Wizard to create a site-to-site VPN between a ZYWALL/USG and a FortiGate router. The example instructs how to configure the VPN tunnel between each site. The example instructs how to configure the VPN tunnel between each site. When the VPN tunnel is configured, each site can be accessed securely.

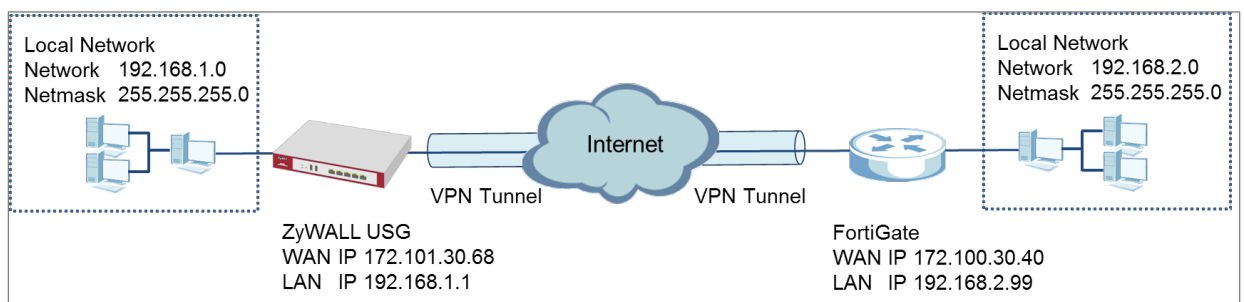

ZyWALL Site-to-site IPSec VPN with FortiGate Connected

 Note: All network IP addresses and subnet masks are used as examples in this article. Please replace them with your actual network IP addresses and subnet masks. This example was tested using USG310 (Firmware Version: ZLD 4.25) and FortiGate 100D (Firmware Version:

## Set Up the IPSec VPN Tunnel on the ZyWALL/USG

In the ZyWALL/USG, go to **Quick Setup > VPN Setup Wizard**, use the **VPN Settings** wizard to create a VPN rule that can be used with the FortiGate. Click **Next**.

### Quick Setup > VPN Setup Wizard > Welcome

VPN Setup Wizard

Wizard Type > VPN Settings > Wizard Completed

1 2 3

**Welcome**

- VPN Settings
  - Wizard Type
  - VPN Settings
  - Wizard Completed
- VPN Settings for Configuration Provisioning
  - Wizard Type
  - VPN Settings
  - Wizard Completed
- VPN Settings for L2TP VPN Settings
  - VPN Settings
  - General Settings
  - Wizard Completed

Choose **Express** to create a VPN rule with the default phase 1 and phase 2 settings and use a pre-shared key to be the authentication method. Click **Next**.

### Quick Setup > VPN Setup Wizard > Wizard Type

VPN Setup Wizard

Wizard Type > VPN Settings > Wizard Completed

1 2 3

Please select the type of VPN policy you wish to setup.

**Type of VPN policy**

- Express
- Advanced

Type the **Rule Name** used to identify this VPN connection (and VPN gateway). You may use 1-31 alphanumeric characters. This value is case-sensitive. Select the rule to be **Site-to-site**. Click **Next**.

**Quick Setup > VPN Setup Wizard > Wizard Type > VPN Settings (Scenario)**

**VPN Setup Wizard**

Wizard Type > **VPN Settings** > Wizard Completed

1 2 3

**Express Settings**

**IKE Version**

- IKEv1
- IKEv2

**Scenario**

Rule Name:

- Site-to-site
- Site-to-site with Dynamic Peer
- Remote Access (Server Role)
- Remote Access (Client Role)

Configure **Secure Gateway** IP as the FortiGate's WAN IP address (in the example, 172.100.30.40). Then, type a secure **Pre-Shared Key** (8-32 characters).

Set **Local Policy** to be the IP address range of the network connected to the ZyWALL/USG and **Remote Policy** to be the IP address range of the network connected to the FortiGate.

**Quick Setup > VPN Setup Wizard > Wizard Type > VPN Settings (Configuration)**

**VPN Setup Wizard**

Wizard Type > **VPN Settings** > Wizard Completed

1 2 3

**Express Settings**

**Configuration**

Secure Gateway:  (IP or FQDN)

Pre-Shared Key:

Local Policy (IP/Mask):  /

Remote Policy (IP/Mask):  /

This screen provides a read-only summary of the VPN tunnel. Click **Save**.

**Quick Setup > VPN Setup Wizard > Welcome > Wizard Type > VPN Settings  
(Summary)**

**VPN Setup Wizard**

Wizard Type > 1
VPN Settings > 2
Wizard Completed > 3

**Express Settings**

**Summary**

Rule Name:	WIZ_VPN_Fortigate
Secure Gateway:	172.100.30.40
Pre-Shared Key:	ZyXEL123
Local Policy (IP/Mask):	192.168.1.0 / 255.255.255.0
Remote Policy (IP/Mask):	192.168.2.0 / 255.255.255.0

Now the rule is configured on the ZyWALL/USG. The Phase 1 rule settings appear in the **VPN > IPSec VPN > VPN Gateway** screen and the Phase 2 rule settings appear in the **VPN > IPSec VPN > VPN Connection** screen. Click **Close** to exit the wizard.

**Quick Setup > VPN Setup Wizard > Welcome > Wizard Type > VPN Settings > Wizard Completed**

Go to **CONFIGURATION > VPN > IPsec VPN > VPN Gateway** and click **Show Advanced Settings**. Configure **Authentication > Peer ID Type** as **Any** to let the ZyWALL/USG does not require to check the identity content of the remote IPsec router.

**CONFIGURATION > VPN > IPsec VPN > VPN Gateway > Show Advanced Settings > Authentication > Peer ID Type**

The screenshot shows the 'Authentication' configuration page. Under the 'Advance' section, the 'Peer ID Type' dropdown menu is highlighted with a red box and is set to 'Any'. Other settings include 'Local ID Type' set to 'IPv4', 'Content' set to '0.0.0.0', and 'Peer ID Content' set to '172.100.30.40'. The 'Pre-Shared Key' is masked with dots, and 'Certificate' is set to 'default'.

## Set Up the IPsec VPN Tunnel on the FortiGate

In the FortiGate **VPN > IPsec > Wizard > Custom VPN Tunnel (No Template)**, use the **VPN Setup** to create a **Site-to-site VPN** rule **Name**.

**VPN > IPsec > Wizard > Custom VPN Tunnel (No Template)**

The screenshot shows the 'VPN Setup' wizard. The 'Name' field contains 'WIZ\_VPN\_ZyWALL' and the 'Template' dropdown is set to 'Custom VPN Tunnel (No Template)'. Both the name field and the selected template are highlighted with red boxes. The list of templates includes 'Dialup - FortiClient (Windows, Mac OS, Android)', 'Site to Site - FortiGate', 'Dialup - iOS (Native)', 'Dialup - Android (Native L2TP/IPsec)', 'Dialup - Cisco Firewall', 'Site to Site - Cisco', and 'Custom VPN Tunnel (No Template)'. Navigation buttons for '< Back', 'Next >', and 'Cancel' are visible at the bottom.

Type the **Name** used to identify this VPN connection, configure **Remote Gateway** IP as the peer ZyWALL/USG's WAN IP address. Select the **Interface** which is connected to the Internet.

### VPN > IPsec > Wizard > Custom VPN Tunnel (No Template) > Network

Name: **WIZ\_VPN\_ZyWALL**

Comments: Comments

**Network**

IP Version:  IPv4  IPv6

Remote Gateway: **Static IP Address**

IP Address: **172.101.30.68**

Interface: **wan1**

Mode Config:

NAT Traversal:

Keypalive Frequency: **10**

Dead Peer Detection:

Static IP Address  
Dialup User  
Dynamic DNS

dmz  
ha1  
ha2  
lan  
**wan1**  
wan2

Go to **Authentication** section, enter **Pre-shared Key** and choose negotiation **Mode** the same as the peer ZyWALL/USG's.

### VPN > IPsec > Wizard > Custom VPN Tunnel (No Template) > Authentication

**Authentication**

Method: **Pre-shared Key**

Pre-shared Key: **ZYXEL123**  Show Key

**IKE**

Version:  1  2

Mode:  Aggressive  **Main (ID protection)**



Configure Phase 1 Proposal and Diffie-Hellman Group as the peer ZyWALL/USG Advanced Settings' **Phase 1 Settings > Proposal** and **Key Group**.

**VPN > IPsec > Wizard > Custom VPN Tunnel (No Template) > Phase 1 Proposal**

**Phase 1 Proposal**

Encryption **DES** Authentication **MD5** ➕ Add

Encryption AES256 ⌵ Authentication SHA256 ⌵ 🗑️ Remove

Encryption 3DES ⌵ Authentication SHA256 ⌵ 🗑️ Remove

Encryption AES128 ⌵ Authentication SHA1 ⌵ 🗑️ Remove

Encryption AES256 ⌵ Authentication SHA1 ⌵ 🗑️ Remove

Encryption 3DES ⌵ Authentication SHA1 ⌵ 🗑️ Remove

---

Diffie-Hellman Group  21  20  19  18  17  16

15  14  5  2  1

Key Lifetime (seconds)  ⌵

Local ID

Go to **Phase 2 Selectors > Advanced** and configure **Phase 2 Proposal** as the peer ZyWALL/USG Advanced Settings' **Phase 2 Settings > Proposal**.

Set **Local Address** to be the IP address range of the network connected to the FortiGate and **Remote Address** to be the IP address range of the network connected to the ZyWALL/USG.

Make sure you uncheck **Enable Perfect Forward Secrecy (PFS)** if this function is disabled in the peer ZyWALL/USG.

**VPN > IPsec > Wizard > Custom VPN Tunnel (No Template) > Phase 2 Selectors**

**Phase 2 Selectors**

Name	Local Address	Remote Address
WIZ_VPN_ZyWALL	192.168.2.0/255.255.255.0	192.168.1.0/255.255.255.0

**Edit Phase 2** ✓ ✕

Name: WIZ\_VPN\_ZyWALL

Comments:

Local Address: Subnet | 192.168.2.0/255.255.255.0

Remote Address: Subnet | 192.168.1.0/255.255.255.0

▼ **Advanced...**

**Phase 2 Proposal**

Encryption	Authentication	Action
DES	SHA1	Remove
AES256	SHA1	Remove
3DES	SHA1	Remove
AES128	SHA256	Remove
AES256	SHA256	Remove
3DES	SHA256	Remove

Enable Replay Detection

Enable Perfect Forward Secrecy (PFS)

This screen provides a summary of the VPN tunnel. Click **OK** to exit the configuration page.

## VPN > IPsec > Wizard > Custom VPN Tunnel (No Template)

Name

Comments

---

**Network**

IP Version  IPv4  IPv6

Remote Gateway

IP Address

Interface

Mode Config

NAT Traversal

Kealive Frequency

Dead Peer Detection

---

**Authentication** [Edit](#)

Authentication Method : Pre-shared Key (Your\_Pre-Shared\_Key)

IKE Version : 1 , Mode : Main (ID protection)

---

**Phase 1 Proposal** [Edit](#)

Algorithms : DES-MD5 AES256-SHA256, 3DES-SHA256, AES128-SHA1, AES256-SHA1, 3DES-SHA1

Diffie-Hellman Group 1

---

**XAUTH** [Edit](#)

Type : Disabled

---

**Phase 2 Selectors**

Name	Local Address	Remote Address	<a href="#">Add</a>
WIZ_VPN_ZyWALL	192.168.2.99/255.255.255.0	192.168.1.1/255.255.255.0	<a href="#">Edit</a>

**OK** **Cancel**

## Test the IPsec VPN Tunnel

Go to ZyWALL/USG **CONFIGURATION > VPN > IPsec VPN > VPN Connection**, click **Connect** on the upper bar. The **Status** connect icon is lit when the interface is connected.

### CONFIGURATION > VPN > IPsec VPN > VPN Connection

#	Status	Name	VPN Gateway	Policy
1		WIZ_VPN_FortiGate	WIZ_VPN_FortiGate	WIZ_VPN_Fortigate_Local/WIZ_VPN_Fortigate_REMOTE

Go to ZyWALL/USG **MONITOR > VPN Monitor > IPsec** and verify the tunnel **Up Time** and **Inbound(Bytes)/Outbound(Bytes)** traffic.

### MONITOR > VPN Monitor > IPsec

#	Serial Number	System Name	Name	Policy	My Address	Secure Gatew...	Up Time	Timeout	Inbound...	Outbound...
1	N/A	N/A	WIZ_VPN_FortiGate	192.168.1.0/...	172.101.30.68	P: 172.100.30.40	68	79132	0(0 bytes)	0(0 bytes)

Go to FortiGate **VPN > Monitor > IPsec Monitor** and check the tunnel **Status** is up and **Incoming Data/Outgoing Data** traffic.

### VPN > Monitor > IPsec Monitor

Name	Type	Remote Gateway	Status	Incoming Data	Outgoing Data
WIZ_VPN_ZyWALL	Static IP or Dynamic DNS	172.101.30.68		8.09 KB	13.78 KB

To test whether or not a tunnel is working, ping from a computer at one site to a computer at the other. Ensure that both computers have Internet access (via the IPsec devices).

**PC behind ZyWALL/USG > Window 7 > cmd > ping 192.168.2.33**

```
C:\Documents and Settings\ZyXEL>ping 192.168.2.33

Pinging 192.168.2.33 with 32 bytes of data:

Reply from 192.168.2.33: bytes=32 time=27ms TTL=43
Reply from 192.168.2.33: bytes=32 time=32ms TTL=43
Reply from 192.168.2.33: bytes=32 time=26ms TTL=43
Reply from 192.168.2.33: bytes=32 time=27ms TTL=43

Ping statistics for 192.168.2.33:
    Packets: Sent = 4, Received = 4, Lost = 0 (0% loss),
    Approximate round trip times in milli-seconds:
        Minimum = 26ms, Maximum = 32ms, Average = 28ms
```

PC behind FortiGate> Window 7 > cmd > ping 192.168.1.33

```
C:\Documents and Settings\ZyXEL>ping 192.168.1.33

Pinging 192.168.1.33 with 32 bytes of data:

Reply from 192.168.1.33: bytes=32 time=27ms TTL=43
Reply from 192.168.1.33: bytes=32 time=32ms TTL=43
Reply from 192.168.1.33: bytes=32 time=26ms TTL=43
Reply from 192.168.1.33: bytes=32 time=27ms TTL=43

Ping statistics for 192.168.1.33:
    Packets: Sent = 4, Received = 4, Lost = 0 (0% loss),
    Approximate round trip times in milli-seconds:
        Minimum = 26ms, Maximum = 32ms, Average = 28ms
```

## What Could Go Wrong?

If you see below [info] or [error] log message, please check ZyWALL/USG Phase 1 Settings. Both ZyWALL/USG and FortiGate must use the same Pre-Shared Key, Encryption, Authentication method, DH key group and ID Type to establish the IKE SA.

### MONITOR > Log

Priority	Category	Message	Note
info	IKE	Send:[NOTIFY:NO_PROPOSAL_CHOSEN]	IKE_LOG
info	IKE	[SA] : No proposal chosen	IKE_LOG
info	IKE	[SA] : Tunnel [WIZ_VPN_FortiGate] Phase 1 proposal mismatch	IKE_LOG
info	IKE	The cookie pair is : 0x70fb3b31ed922dc4 / 0x07f7812272f2e1a2 [count=3]	IKE_LOG
info	IKE	Recv IKE sa: SA([0] protocol = IKE (1), AES CBC key len = 192, HMAC-SHA256 PRF, HMAC-SHA256-1...	IKE_LOG

If you see that Phase 1 IKE SA process done but still get below [info] log message,

please check ZyWALL/USG and FortiGate Phase 2 Settings. Both ZyWALL/USG and FortiGate must use the same Protocol, Encapsulation, Encryption, Authentication method and PFS to establish the IKE SA.

## MONITOR > Log

info	IKE	[SA] : No proposal chosen	IKE_LOG
info	IKE	[SA] : Tunnel [WIZ_VPN_FortiGate] Phase 2 proposal mismatch	IKE_LOG
info	IKE	Recv:[HASH][SA][NONCE][ID][ID]	IKE_LOG
info	IKE	Phase 1 IKE SA process done	IKE_LOG

Make sure the both ZyWALL/USG and FortiGate security policies allow IPSec VPN traffic. IKE uses UDP port 500, AH uses IP protocol 51, and ESP uses IP protocol 50.

Default NAT traversal is enable on ZyWALL/USG, please make sure the remote IPSec device must also have NAT traversal enabled.

## How to Configure Site-to-site IPSec VPN with WatchGuard

This example shows how to use the VPN Setup Wizard to create a site-to-site VPN between a ZYWALL/USG and a WatchGuard router. The example instructs how to configure the VPN tunnel between each site. When the VPN tunnel is configured, each site can be accessed securely.

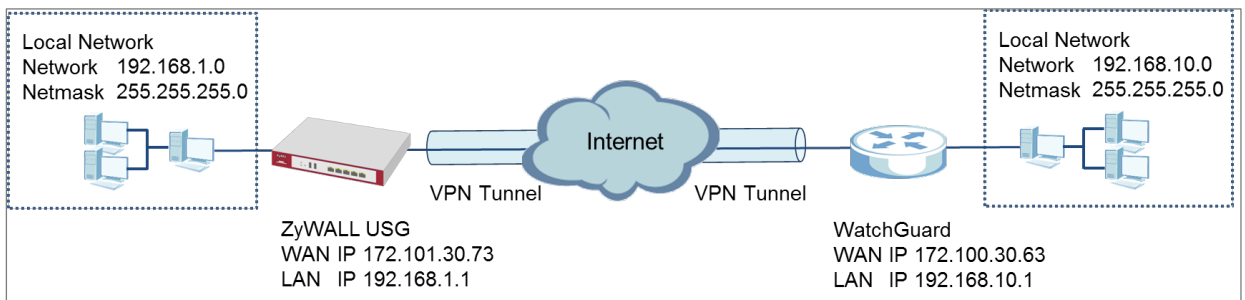

ZyWALL Site-to-site IPSec VPN with WatchGuard Connected

 Note: All network IP addresses and subnet masks are used as examples in this article. Please replace them with your actual network IP addresses and subnet masks. This example was tested using USG310 (Firmware Version: ZLD 4.25) and WatchGuard XTM 515 (Firmware Version: 11.10.4).

## Set Up the IPSec VPN Tunnel on the ZyWALL/USG

In the ZyWALL/USG, go to **Quick Setup > VPN Setup Wizard**, use the **VPN Settings** wizard to create a VPN rule that can be used with the WatchGuard. Click **Next**.

### Quick Setup > VPN Setup Wizard > Welcome

VPN Setup Wizard

Wizard Type > VPN Settings > Wizard Completed

1 2 3

**Welcome**

- VPN Settings
  - Wizard Type
  - VPN Settings
  - Wizard Completed
- VPN Settings for Configuration Provisioning
  - Wizard Type
  - VPN Settings
  - Wizard Completed
- VPN Settings for L2TP VPN Settings
  - VPN Settings
  - General Settings
  - Wizard Completed

Choose **Express** to create a VPN rule with the default phase 1 and phase 2 settings and use a pre-shared key to be the authentication method. Click **Next**.

### Quick Setup > VPN Setup Wizard > Wizard Type

VPN Setup Wizard

Wizard Type > VPN Settings > Wizard Completed

1 2 3

Please select the type of VPN policy you wish to setup.

**Type of VPN policy**

- Express
- Advanced



Type the **Rule Name** used to identify this VPN connection (and VPN gateway). You may use 1-31 alphanumeric characters. This value is case-sensitive. Select the rule to be **Site-to-site**. Click **Next**.

**Quick Setup > VPN Setup Wizard > Wizard Type > VPN Settings (Scenario)**

**VPN Setup Wizard**

Wizard Type > VPN Settings > Wizard Completed

1 2 3

**Express Settings**

**IKE Version**

IKEv1

IKEv2

**Scenario**

Rule Name:

Site-to-site

Site-to-site with Dynamic Peer

Remote Access (Server Role)

Remote Access (Client Role)

Configure **Secure Gateway** IP as the WatchGuard's WAN IP address (in the example, 172.100.30.63). Then, type a secure **Pre-Shared Key** (8-32 characters).

Set **Local Policy** to be the IP address range of the network connected to the ZyWALL/USG and **Remote Policy** to be the IP address range of the network connected to the WatchGuard. Click **OK**.

**Quick Setup > VPN Setup Wizard > Wizard Type > VPN Settings (Configuration)**

**VPN Setup Wizard**

Wizard Type > VPN Settings > Wizard Completed

1 2 3

**Express Settings**

**Configuration**

Secure Gateway:  (IP or FQDN)

Pre-Shared Key:

Local Policy (IP/Mask):  /

Remote Policy (IP/Mask):  /

This screen provides a read-only summary of the VPN tunnel. Click **Save**.

**Quick Setup > VPN Setup Wizard > Welcome > Wizard Type > VPN Settings (Summary)**

**VPN Setup Wizard**

[Wizard Type](#) > [VPN Settings](#) > [Wizard Completed](#)

**Express Settings**

**Summary**

Rule Name:	VPN_to_WatchGuard
Secure Gateway:	172.100.30.63
Pre-Shared Key:	ZyXEL123
Local Policy (IP/Mask):	192.168.1.0 / 255.255.255.0
Remote Policy (IP/Mask):	192.168.10.0 / 255.255.255.0

Now the rule is configured on the ZyWALL/USG. The Phase 1 rule settings appear in the **VPN > IPSec VPN > VPN Gateway** screen and the Phase 2 rule settings appear in the **VPN > IPSec VPN > VPN Connection** screen. Click **Close** to exit the wizard.

**Quick Setup > VPN Setup Wizard > Wizard Type > VPN Settings > Wizard completed**

**VPN Setup Wizard**

[Wizard Type](#) > [VPN Settings](#) > [Wizard Completed](#)

**Express Settings**

Congratulations. The VPN Access wizard is completed

**Summary**

Rule Name:	VPN_to_WatchGuard
Secure Gateway:	172.100.30.63
Pre-Shared Key:	ZyXEL123
Local Policy (IP/Mask):	192.168.1.0 / 255.255.255.0
Remote Policy (IP/Mask):	192.168.10.0 / 255.255.255.0

Go to **CONFIGURATION > VPN > IPSec VPN > VPN Gateway**, click **Show Advanced Settings**. Configure **Authentication > Local ID Type** as **IPv4** and set the **Content** as

your ZyWALL/USG's **WAN IP Address** (in the example, 172.101.30.73). Then, configure **Authentication > Remote ID Type** as **IPv4** and set the **Content** as your WatchGuard's **External IP Address** (in the example, 172.100.30.63). Click **OK**.

**CONFIGURATION > VPN > IPSec VPN > VPN Gateway > Show Advanced Settings > Authentication > Peer ID Type**

**Authentication**

Pre-Shared Key   
 unmasked

Certificate  (See [My Certificates](#))

User Based PSK  ⓘ

**Advance**

Local ID Type:   
 Content:   
 Peer ID Type:   
 Content:

## Set Up the IPSec VPN Tunnel on the WatchGuard

Go to **Dashboard > Network Interfaces** to check your **External IP Address** (the Internet-facing interface) and **Trusted IP Address** (the Local IP address).

**Dashboard > Network Interfaces**

Link Status	Alias	IPv4 Address	Gateway
Up	External	172.100.30.63/24	172.100.30.1
Up	Trusted	192.168.10.1/24	0.0.0.0
Down	Optional-1	0.0.0.0/0	0.0.0.0
Down	Optional-2	0.0.0.0/0	0.0.0.0
Down	Optional-3	0.0.0.0/0	0.0.0.0
Down	Optional-4	0.0.0.0/0	0.0.0.0
Down	Optional-5	0.0.0.0/0	0.0.0.0

In the WatchGuard **VPN > Branch Office VPN > Gateway > General Settings** create a Site-to-site VPN **Gateway Name** and set a secure **Pre-Shared Key**.

**VPN > Branch Office VPN > Gateway > General Settings > Credential Method**

Gateway Name: **VPN\_to\_ZyWALL**

General Settings | Phase 1 Settings

**Credential Method**

Use Pre-Shared Key: **\*\*\*\*\***

Use IPSec Firebox Certificate

ID	Certificate Name	Algorithm

To add a **Gateway Endpoint**, click **Add**.

**VPN > Branch Office VPN > Gateway > General Settings > Gateway Endpoints**

**Gateway Endpoints**

Local Type	Local ID	Local Interface	Remote IP	Remote Type	Remote ID

**Add** | Edit | Remove

The new **Gateway Endpoint** dialog box appears. Configure your **Local Gateway** identity as WatchGuard's **External IP Address** (in the example, 172.100.30.63) and **Remote Gateway** identity as your ZyWALL/USG's **WAN IP Address** (in the example, 172.101.30.73). Click **OK**.

**VPN > Branch Office VPN > Gateway > General Settings > Gateway Endpoints**

**Gateway Endpoint Settings** ✕

A tunnel needs authentication on each side of the tunnel. Provide the configuration details for the gateway endpoints below.

**Local Gateway**

Specify the gateway ID for tunnel authentication.

By IP Address

By Domain Name

By User ID on Domain

By x500 Name

External Interface  ▾

**Remote Gateway**

Specify the remote gateway IP address for a tunnel.

Static IP Address

Dynamic IP Address

Specify the gateway ID for tunnel authentication.

By IP Address

By Domain Name

By User ID on Domain

By x500 Name

Attempt to resolve domain

Then, go to **VPN > Branch Office VPN > Gateway > Phase 1 Settings** to select negotiation **Mode** the same as your ZyWALL/USG's Phase 1 Settings. Make sure you enable both **NAT Traversal** and **Dead Peer Detection** options if both options are enabled in the ZyWALL/USG.

### VPN > Branch Office VPN > Gateway > Phase 1 Settings

**Gateway**

Gateway Name: VPN\_to\_ZyWALL

**Phase 1 Settings**

Mode: **Main**

NAT Traversal  
Keep-alive Interval: 20 Seconds

IKE Keep-alive  
Message Interval: 30 Seconds  
Max failure: 5

Dead Peer Detection (RFC370)  
Traffic idle timeout: 20 Seconds  
Max retry: 5

Use **Transform Settings** to create the same security settings as in the ZyWALL/USG Phase 1 settings. Click **OK** and **Save** to exit the **Transform Settings** page.

### VPN > Branch Office VPN > Gateway > Phase 1 Settings > Transform Settings

**Transform Settings**

Authentication: **MD5**

Encryption: **DES**

SA Life: 24 hour

Key Group: **Diffie-Hellman Group 1**

Buttons: Add, Edit, Remove, Up, Down, OK, Cancel, Save, Cancel

Then, go to **VPN > Branch Office VPN > Tunnel** to add a Tunnel Route Settings. In the **Local IP** section, set **the Network IP** to be the IP address range of the network connected to the WatchGuard. In the **Remote IP** section, set **the Network IP** to be the IP address range of the network connected to the ZyWALL/USG. Click **OK**.

### VPN > Branch Office VPN > Tunnel > Address

**Tunnel Route Settings**

Addresses NAT

**Local IP**

Choose Type: Network IP

Network IP: 192.168.10.0 / 24

**Remote IP**

Choose Type: Network IP

Network IP: 192.168.1.0 / 24

Direction: bi-directional

Enable broadcast routing over the tunnel

OK Cancel

Go to **VPN > Branch Office VPN > Tunnel > Phase 2 Settings** to create a **Tunnel Name**. Then, select the **Gateway**. Make sure you enable **Perfect Forward Secrecy** and select **Diffie-Hellman Group 2**. Then, scroll down **Phase 2 Proposals** and add the encryption types to match your ZyWALL/USG's **VPN Connection > Phase 2 Settings**. Click **Save**.

## VPN > Branch Office VPN > Tunnel > Phase 2 Settings

The screenshot shows the 'Tunnel' configuration window with the following details:

- Tunnel Name:** VPN\_to\_ZyWALL
- Gateway:** VPN to ZyWALL (highlighted with a red box)
- Perfect Forward Secrecy:**  Enable Perfect Forward Secrecy. Diffie-Hellman Group 2 (selected from a dropdown menu).
- IPSec Proposals:** A table with the header 'Phase 2 Proposals' and three empty rows. To the right of the table are buttons for 'Remove', 'Up', and 'Down'.
- Encryption Type Selection:** A dropdown menu is open, showing options: ESP-3DES-MD5, ESP-AES-SHA1, ESP-AES-MD5, ESP-3DES-SHA1, and ESP-DES-SHA1. The 'ESP-DES-SHA1' option is highlighted with a red box. An 'Add' button (also highlighted with a red box) is located to the right of the dropdown.
- Buttons:** 'Save' and 'Cancel' buttons are at the bottom right, with 'Save' highlighted by a red box.



## Test the IPsec VPN Tunnel

Go to ZyWALL/USG **CONFIGURATION > VPN > IPsec VPN > VPN Connection**, click **Connect** on the upper bar. The **Status** connect icon is lit when the interface is connected.

### CONFIGURATION > VPN > IPsec VPN > VPN Connection

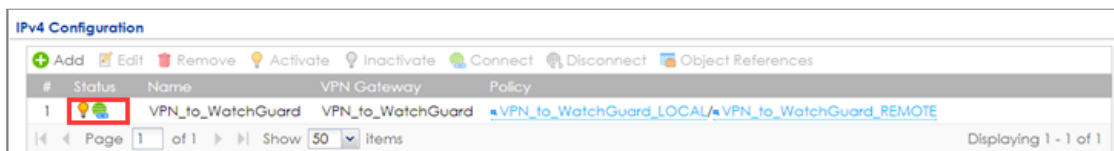

Go to ZyWALL/USG **MONITOR > VPN Monitor > IPsec** and verify the tunnel **Up Time** and **Inbound(Bytes)/Outbound(Bytes)** traffic.

### MONITOR > VPN Monitor > IPsec

The screenshot shows the 'VPN Monitor' page. At the top, there are buttons for 'Disconnect' and 'Connection Check'. Below is a table with columns: #, Serial Num..., System Na..., Name, Policy, My Address, Secure Gateway, Up Time, Timeout, Inbound[B..., and Outbound[...]. The first row shows: 1, N/A, N/A, VPN\_to\_WatchGuard, 192.168.1.0/24..., 172.101.30.73, P:172.100.30.63, 97, 76223, 0[0 bytes], 0[0 bytes]. At the bottom, there is a pagination control showing 'Page 1 of 1' and 'Show 50 items'.

Go to WatchGuard **System Status > VPN Statistics > Branch Office VPN** and check the tunnel **Status** is up and **Bytes In** (Incoming Data) and **Bytes Out** (Outgoing Data).

### System Status > VPN Statistics > Branch Office

The screenshot shows the 'VPN Statistics' page. At the top, there is a 'Refresh Interval (30s):' slider set to 5, with a 'Pause' button. Below is a table with columns: Name, Local, Remote, Gateway, Packets In, Bytes In, Packets Out, Bytes Out, and Rekeys. The first row shows: VPN\_to\_ZyWALL, 192.168.10.0/24, 192.168.1.0/24, 172.100.30.63 -172.101.30.73, 265, 15900, 384, 23635, 0. At the bottom right, there is a 'Copy' button.

To test whether or not a tunnel is working, ping from a computer at one site to a computer at the other. Ensure that both computers have Internet access (via the IPsec devices).

## PC behind ZyWALL/USG > Window 7 > cmd > ping 192.168.10.33

```
C:\Documents and Settings\ZyXEL>ping 192.168.10.33

Pinging 192.168.10.33 with 32 bytes of data:

Reply from 192.168.10.33: bytes=32 time=18ms TTL=54
Reply from 192.168.10.33: bytes=32 time=17ms TTL=54
Reply from 192.168.10.33: bytes=32 time=17ms TTL=54
Reply from 192.168.10.33: bytes=32 time=16ms TTL=54

Ping statistics for 192.168.10.33:
    Packets: Sent = 4, Received = 4, Lost = 0 (0% loss),
    Approximate round trip times in milli-seconds:
        Minimum = 16ms, Maximum = 18ms, Average = 17ms
```

## PC behind WatchGuard > Window 7 > cmd > ping 192.168.1.33

```
C:\Documents and Settings\ZyXEL>ping 192.168.1.33

Pinging 192.168.1.33 with 32 bytes of data:

Reply from 192.168.1.33: bytes=32 time=27ms TTL=43
Reply from 192.168.1.33: bytes=32 time=32ms TTL=43
Reply from 192.168.1.33: bytes=32 time=26ms TTL=43
Reply from 192.168.1.33: bytes=32 time=27ms TTL=43

Ping statistics for 192.168.1.33:
    Packets: Sent = 4, Received = 4, Lost = 0 (0% loss),
    Approximate round trip times in milli-seconds:
        Minimum = 26ms, Maximum = 32ms, Average = 28ms
```

## What Could Go Wrong?

If you see below [info] or [error] log message, please check ZyWALL/USG Phase 1 Settings. Both ZyWALL/USG and WatchGuard must use the same Pre-Shared Key, Encryption, Authentication method, DH key group and ID Type to establish the IKE SA.

### MONITOR > Log

Priority	Category	Message	Source	Destination	Note
Info	IKE	Send:[NOTIFY:NO_PROPOSAL_CHOSEN]	172.101.30.73:500	172.100.30.63:500	IKE_LOG
Info	IKE	[SA] : No proposal chosen	172.101.30.73:500	172.100.30.63:500	IKE_LOG
Info	IKE	[SA] : Tunnel [VPN_to_WatchGuard] Phase 1 proposal mismatch	172.101.30.73:500	172.100.30.63:500	IKE_LOG

If you see that Phase 1 IKE SA process done but still get below [info] log message,

please check ZyWALL/USG and WatchGuard Phase 2 Settings. Both ZyWALL/USG and WatchGuard must use the same Protocol, Encapsulation, Encryption, Authentication method and PFS to establish the IKE SA.

## MONITOR > Log

info	IKE	[SA] : No proposal chosen	172.101.30.73:500	172.100.30.63:500	IKE_LOG
info	IKE	[SA] : Tunnel [VPN_to_WatchGuard] Phase 2 proposal mismatch	172.101.30.73:500	172.100.30.63:500	IKE_LOG
info	IKE	Recv:[HASH][SA][NONCE][ID][ID]	172.100.30.63:500	172.101.30.73:500	IKE_LOG
info	IKE	Phase 1 IKE SA process done	172.101.30.73:500	172.100.30.63:500	IKE_LOG

Make sure the both ZyWALL/USG and WatchGuard security policies allow IPSec VPN traffic. IKE uses UDP port 500, AH uses IP protocol 51, and ESP uses IP protocol 50.

Default NAT traversal is enable on ZyWALL/USG, please make sure the remote IPSec device must also have NAT traversal enabled.

## How to Configure Site-to-site IPSec VPN with Cisco

This example shows how to use the VPN Setup Wizard to create a site-to-site VPN between a ZYWALL/USG and a Cisco router. The example instructs how to configure the VPN tunnel between each site. When the VPN tunnel is configured, each site can be accessed securely.

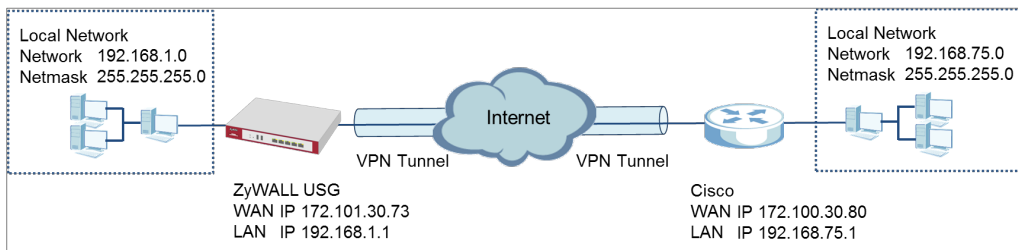

ZyWALL Site-to-site IPSec VPN with Cisco Connected

 Note: All network IP addresses and subnet masks are used as examples in this article. Please replace them with your actual network IP addresses and subnet masks. This example was tested using USG310 (Firmware Version: ZLD 4.25) and ISA500 (Firmware Version: 1.0.3).

## Set Up the IPSec VPN Tunnel on the ZyWALL/USG

In the ZyWALL/USG, go to **Quick Setup > VPN Setup Wizard**, use the **VPN Settings** wizard to create a VPN rule that can be used with the Cisco. Click **Next**.

### Quick Setup > VPN Setup Wizard > Welcome

VPN Setup Wizard

Wizard Type > VPN Settings > Wizard Completed

1 2 3

**Welcome**

- VPN Settings
  - Wizard Type
  - VPN Settings
  - Wizard Completed
- VPN Settings for Configuration Provisioning
  - Wizard Type
  - VPN Settings
  - Wizard Completed
- VPN Settings for L2TP VPN Settings
  - VPN Settings
  - General Settings
  - Wizard Completed

Choose **Advanced** to create a VPN rule with the customize phase 1, phase 2 settings and authentication method. Click **Next**.

### Quick Setup > VPN Setup Wizard > Wizard Type

VPN Setup Wizard

Wizard Type > VPN Settings > Wizard Completed

1 2 3

Please select the type of VPN policy you wish to setup.

Type of VPN policy

- Express
- Advanced

Type the **Rule Name** used to identify this VPN connection (and VPN gateway). You may use 1-31 alphanumeric characters. This value is case-sensitive. Select the rule to be **Site-to-site**. Click **Next**.

**Quick Setup > VPN Setup Wizard > Wizard Type > VPN Settings (Scenario)**

The screenshot shows the 'VPN Setup Wizard' interface. At the top, there is a breadcrumb trail: 'Wizard Type > VPN Settings > Wizard Completed'. Below this, there are three numbered steps: 1, 2, and 3. The current step is 'VPN Settings (Scenario)'. Under the heading 'Advanced Settings', there are two sections: 'IKE Version' and 'Scenario'. In the 'IKE Version' section, 'IKEv1' is selected with a radio button. In the 'Scenario' section, the 'Rule Name' field contains 'VPN\_to\_Cisco'. Below this, 'Site-to-site' is selected with a radio button. Other options in the 'Scenario' section include 'Site-to-site with Dynamic Peer', 'Remote Access (Server Role)', and 'Remote Access (Client Role)'.

Then, configure the **Secure Gateway** IP as the Cisco's Gateway IP address (in the example, 172.100.30.80); select **My Address** to be the interface connected to the Internet.

Set the desired **Negotiation, Encryption, Authentication, Key Group** and **SA Life Time** settings. Type a secure **Pre-Shared Key** (8-32 characters) which must match your Cisco **Pre-Shared Key**. Click **OK**.

**Quick Setup > VPN Setup Wizard > Wizard Type > VPN Settings (Phase 1 Setting)**

### VPN Setup Wizard

Wizard Type >
VPN Settings >
Wizard Completed

1
2
3

#### Advanced Settings

##### Phase 1 Setting

Secure Gateway:  (IP or FQDN)

My Address (interface):

Negotiation Mode:

Encryption Algorithm:

Authentication Algorithm:

Key Group:

SA Life Time:  (180 - 3000000 seconds)

NAT Traversal

Dead Peer Detection (DPD)

##### Authentication Method

Pre-Shared Key

Certificate

Continue to **Phase 2 Settings** to select the desired **Encapsulation**, **Encryption**, **Authentication**, and **Perfect Forward Secrecy (PFS)** settings.

Set **Local Policy** to be the IP address range of the network connected to the ZyWALL/USG and **Remote Policy** to be the IP address range of the network connected to the Cisco. Click **OK**.

**Quick Setup > VPN Setup Wizard > Wizard Type > VPN Settings (Phase 2 Setting)**

### VPN Setup Wizard

Wizard Type > VPN Settings > Wizard Completed

1
2
3

#### Advanced Settings

##### Phase 2 Setting

Active Protocol:

Encapsulation:

Encryption Algorithm:

Authentication Algorithm:

SA Life Time:  (180 - 3000000 seconds)

Perfect Forward Secrecy (PFS):

##### Policy Setting

Local Policy (IP/Mask):  /

Remote Policy (IP/Mask):  /

##### Property

Nailed-Up

This screen provides a read-only summary of the VPN tunnel. Click **Save**.

### Quick Setup > VPN Setup Wizard > Welcome > Wizard Type > VPN Settings (Summary)

### VPN Setup Wizard

Wizard Type > VPN Settings > Wizard Completed

1
2
3

#### Advanced Settings

##### Summary

Rule Name: VPN\_to\_Cisco

Secure Gateway: 172.100.30.80

Pre-Shared Key: ZyXEL123

Local Policy (IP/Mask): 192.168.1.0 / 255.255.255.0

Remote Policy (IP/Mask): 192.168.75.0 / 255.255.255.0

##### Phase 1

Negotiation Mode: main

Encryption Algorithm: des

Authentication Algorithm: md5

Key Group: DH2

##### Phase 2

Active Protocol: esp

Encapsulation: tunnel

Encryption Algorithm: 3des

Authentication Algorithm: md5



Now the rule is configured on the ZyWALL/USG. The Phase 1 rule settings appear in the **VPN > IPSec VPN > VPN Gateway** screen and the Phase 2 rule settings appear in the **VPN > IPSec VPN > VPN Connection** screen. Click **Close** to exit the wizard.

**Quick Setup > VPN Setup Wizard > Welcome > Wizard Type > VPN Settings > Wizard Completed**

**VPN Setup Wizard**

Wizard Type > VPN Settings > Wizard Completed

1
2
3

**Advanced Settings**

Congratulations. The VPN Access wizard is completed

Summary

Rule Name:	VPN_to_Cisco
Secure Gateway:	172.100.30.80
My Address (interface):	ge1
Pre-shared Key:	ZyXEL123

**Phase 1**

Negotiation Mode:	main
Encryption Algorithm:	des
Authentication Algorithm:	md5
Key Group:	DH2
SA Life Time:	86400
NAT Traversal:	true
Dead Peer Detection (DPD):	true

**Phase 2**

Active Protocol:	esp
Encapsulation:	tunnel
Encryption Algorithm:	3des
Authentication Algorithm:	md5
SA Life Time:	86400
Perfect Forward Secrecy (PFS):	DH2

**Policy**

Local Policy (IP/Mask):	192.168.1.0 / 255.255.255.0
Remote Policy (IP/Mask):	192.168.75.0 / 255.255.255.0
Nailed-Up:	true

Go to **CONFIGURATION > VPN > IPsec VPN > VPN Gateway** and click **Show Advanced Settings**. Configure **Authentication > Peer ID Type** as **Any** to let the ZyWALL/USG does not require to check the identity content of the remote IPsec router.

The screenshot shows the 'Authentication' configuration page. Under 'Pre-Shared Key', there is a masked key field and an 'unmasked' checkbox. Below are 'Certificate' (set to 'default') and 'User Based PSK' (set to 'Remote\_Client'). The 'Advance' section is expanded, showing 'Local ID Type' as 'IPv4', 'Content' as '0.0.0.0', and 'Peer ID Type' as 'Any' (highlighted with a red box). There is also an information icon next to the 'User Based PSK' dropdown.

**CONFIGURATION > VPN > IPsec VPN > VPN Gateway > Show Advanced Settings > Authentication > Peer ID Type**

## Set Up the IPsec VPN Tunnel on the Cisco

To create an **Address Object Name** of your peer ZyWALL/USG Local IP address, go to **Networking > Address Management > Address Objects** and click **Add Address**. Select **Network** as the **Type**. Configure **IP Address** and **Netmask** to be the IP address range of the network connected to the ZyWALL/USG. Click **OK**.

**Networking > Address Management > Address Objects**

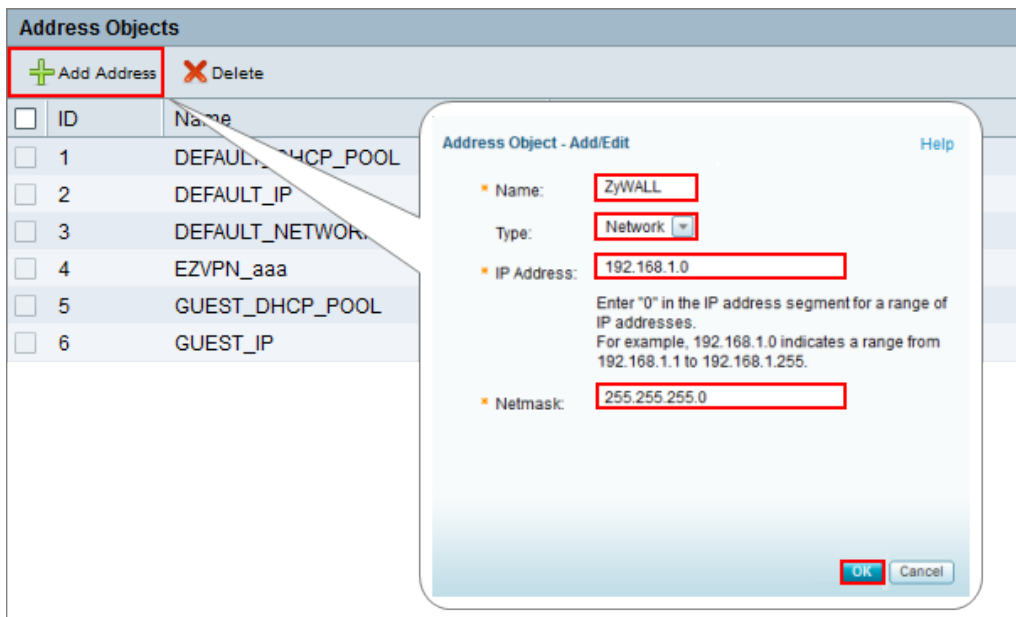

Go to **VPN > Site-to-site > IKE Policies**, click **Add** to create a new IKE Policy **Name**. Then, select **Encryption, Hash, Pre-shared Key** and **D-H Group** to match your ZyWALL/USG's **VPN Gateway > Phase 1 Settings**. Set **Lifetime** to **24** hours and click **OK** then click **Save** to exit the **IKE Policies** page.

## VPN > Site-to-site > IKE Policies

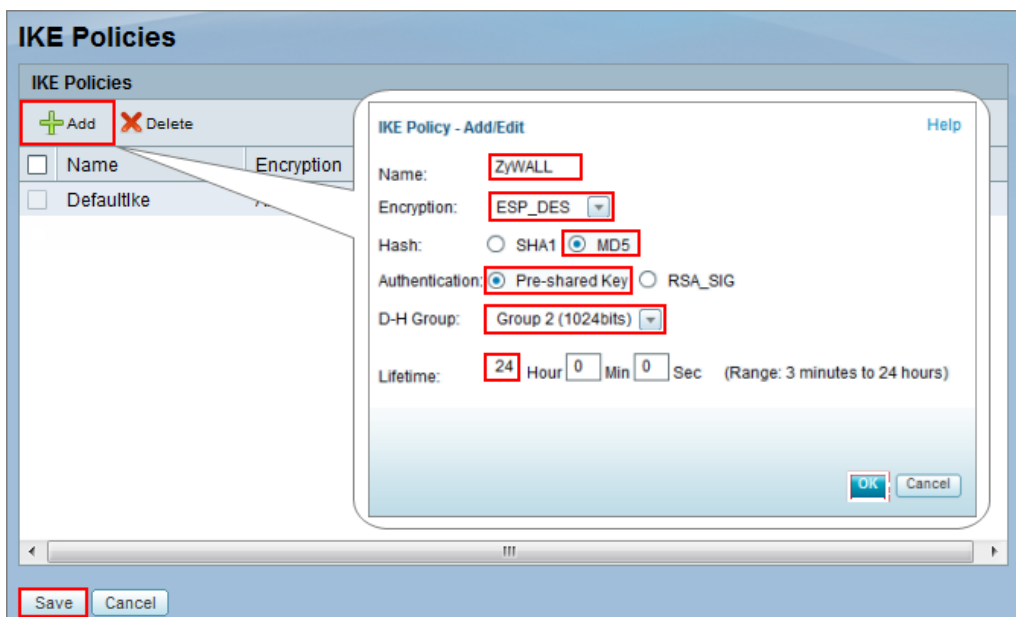

Go to **VPN > Site-to-site > Transform Sets**, click **Add** to create a new **Transform Set** name. Then, select **Integrity** and **Encryption** to match your ZyWALL/USG's **VPN Connection > Phase 2 Settings**. Click **OK** and click **Save** to exit the **Transform Sets** page.

## VPN > Site-to-site > Transform Sets

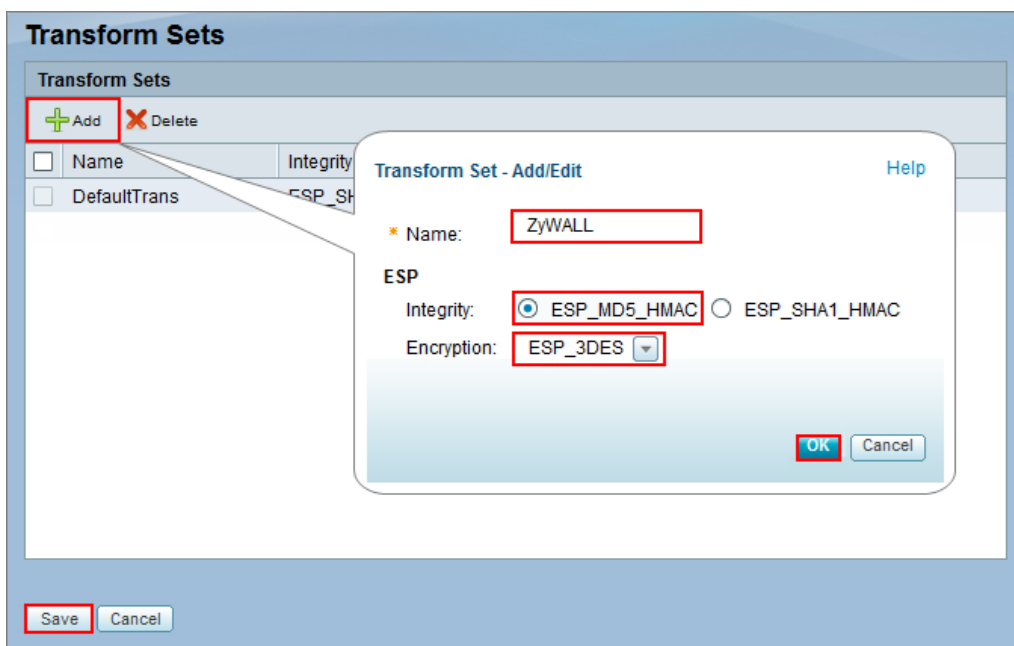

Go to **VPN > Site-to-site > IPsec Policies** and click **Add**. The new **IPsec Policies** dialog box appears. Go to **Basic Settings**, create IPsec policy **Description** name and click **On** the **IPsec Policy Enable** option.

Select **Static IP** as the **Remote Type**. Set **Remote Address** to be your ZyWALL/USG's WAN IP Address (in the example, 172.101.30.73). Enter the same **Pre-Shared Key** as you created in ZyWALL/USG. Then, set **WAN Interface** to the Internet-facing interface (found under **Status > WAN Interface**).

Select **Local network** to be the IP address range of the network connected to the Cisco (found under **Status > LAN Interface**) and **Remote network** to be the IP

address range of the network connected to the ZyWALL/USG (**Address Object** created in Step 1)

**VPN > Site-to-site > IPsec Policies > Basic Settings**

The screenshot shows the 'IPsec Policies - Add/Edit' dialog box with the 'Basic Settings' tab selected. The following fields are visible and highlighted with red boxes:

- Description:** VPN\_to\_ZYWALL
- IPsec Policy Enable:** On (radio button selected)
- Remote Type:** Static IP (dropdown menu)
- Remote Address:** 172.101.30.73
- Authentication Method:** Pre-Shared Key (radio button selected)
- Key:** ZyWALL123
- Local Certificate:** default (dropdown menu)
- Remote Certificate:** default (dropdown menu)
- WAN Interface:** WAN1 (dropdown menu)
- Local network:** DEFAULT\_NETWORK (dropdown menu)
- Remote network:** ZyWALL (dropdown menu)

At the bottom right of the dialog box, there are 'OK' and 'Cancel' buttons.

Then, go to **Advanced Settings** enable **PFS** and **DPD** if you enable both options in the ZyWALL/USG. Set **IKE Policy** to be the **IKE Policy** created in Step 2 (found under **IKE Policy Link**); set **Transform** to be the **Transform Set** created in Step 3 (found under **Transform Link**) and **SA-Lifetime** to be **24** hours.

Click **OK**. The connection active dialog box appears. Click **Activate Connection**.

**VPN > Site-to-site > IPsec Policies > Advanced Settings**

**IPsec Policies - Add/Edit** Help

Basic Settings **Advanced Settings** VPN Failover

PFS Enable:  On  Off

DPD Enable:  On  Off

Delay Time:  (Range: 10-300 s)

Detection Timeout:  (Range: 30-1800 s)

DPD Action:

Apply NAT Policies:  On  Off

Translates Local Network:

Translates Remote Network:

IKE Policy:  [IKE Policy Link](#)

Transform:  [Transform Link](#)

SA-Lifetime:  Hour  Min  Sec (Range: 3 minutes to 24 hours)

 **Do you want to make this connection active when the settings are saved?**

## Test the IPsec VPN Tunnel

Go to ZyWALL/USG **CONFIGURATION > VPN > IPsec VPN > VPN Connection**, click **Connect** on the upper bar. The **Status** connect icon is lit when the interface is connected.

### CONFIGURATION > VPN > IPsec VPN > VPN Connection

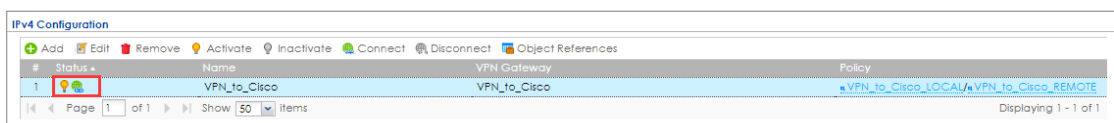

Go to ZyWALL/USG **MONITOR > VPN Monitor > IPsec** and verify the tunnel **Up Time** and **Inbound(Bytes)/Outbound(Bytes)** traffic.

### MONITOR > VPN Monitor > IPsec

#	Serial Number	System Name	Name	Policy	My Address	Secure Gate...	Up Time	Timeout	Inbound(Bytes)	Outbound(Byte...
1	N/A	N/A	VPN_to_Cisco	192.168.1.0/24<->192.168.2.0/24	172.101.30.73	P: 172.100.30.80	53	79147	0(0 bytes)	0(0 bytes)

Go to Cisco **VPN > VPN Status > IPsec VPN Status > Active Sessions** and check the tunnel **Status** is up.

### VPN > VPN Status > IPsec VPN Status > Active Sessions

<input type="checkbox"/>	Name	Status	VPN Type	WAN Interface	Remote Gateway	Local Network	Remote Network	Connect
<input type="checkbox"/>	VPN_to_ZyWALL	Up	Site to Site	WAN1	172.101.30.73	192.168.75.0/24	192.168.1.0/24	

Go to Cisco **VPN > VPN Status > IPsec VPN Status > Statistics** and check the **Tx Packets** (Transmit data) and **Rx Packets** (Receive data).

### VPN > VPN Status > IPsec VPN Status > Statistics

Active Sessions <b>Statistics</b> Teleworker VPN Client							
IPsec VPN Statistic							
Name	VPN Type	WAN Interface	Remote Gateway	Tx Bytes	Rx Bytes	Tx Packets	Rx Packets
VPN_to_ZyWALL	Site to Site	WAN1	172.101.30.73	60665	45180	758	753

To test whether a tunnel is working, ping from a computer at one site to a computer at the other. Ensure that both computers have Internet access (via the IPsec devices).

**PC behind ZyWALL/USG > Window 7 > cmd > ping 192.168.75.33**

```
C:\Documents and Settings\ZyXEL>ping 192.168.75.33

Pinging 192.168.75.33 with 32 bytes of data:

Reply from 192.168.75.33: bytes=32 time=18ms TTL=54
Reply from 192.168.75.33: bytes=32 time=17ms TTL=54
Reply from 192.168.75.33: bytes=32 time=17ms TTL=54
Reply from 192.168.75.33: bytes=32 time=16ms TTL=54

Ping statistics for 192.168.75.33:
    Packets: Sent = 4, Received = 4, Lost = 0 (0% loss),
Approximate round trip times in milli-seconds:
    Minimum = 16ms, Maximum = 18ms, Average = 17ms
```

**PC behind Cisco > Window 7 > cmd > ping 192.168.1.33**

```
C:\Documents and Settings\ZyXEL>ping 192.168.1.33

Pinging 192.168.1.33 with 32 bytes of data:

Reply from 192.168.1.33: bytes=32 time=27ms TTL=43
Reply from 192.168.1.33: bytes=32 time=32ms TTL=43
Reply from 192.168.1.33: bytes=32 time=26ms TTL=43
Reply from 192.168.1.33: bytes=32 time=27ms TTL=43

Ping statistics for 192.168.1.33:
    Packets: Sent = 4, Received = 4, Lost = 0 (0% loss),
Approximate round trip times in milli-seconds:
    Minimum = 26ms, Maximum = 32ms, Average = 28ms
```



## What Could Go Wrong?

If you see below [info] or [error] log message, please check ZyWALL/USG Phase 1 Settings. Both ZyWALL/USG and Cisco must use the same Pre-Shared Key, Encryption, Authentication method, DH key group and ID Type to establish the IKE SA.

### MONITOR > Log

Priority	Category	Message	Source	Destination	Note
info	IKE	Send:[HASH][NOTIFY:NO_PROPOSAL_CHOSEN]	172.101.30.73:500	172.100.30.80:500	IKE_LOG
info	IKE	[SA] : No proposal chosen	172.101.30.73:500	172.100.30.80:500	IKE_LOG
info	IKE	[SA] : Tunnel [VPN_to_Cisco] Phase 1 proposal mismatch	172.101.30.73:500	172.100.30.80:500	IKE_LOG

If you see that Phase 1 IKE SA process done but still get below [info] log message, please check ZyWALL/USG and Cisco Phase 2 Settings. Both ZyWALL/USG and Cisco must use the same Protocol, Encapsulation, Encryption, Authentication method and PFS to establish the IKE SA.

### MONITOR > Log

info	IKE	Send:[HASH][NOTIFY:NO_PROPOSAL_CHOSEN]	172.101.30.73:500	172.100.30.80:500	IKE_LOG
info	IKE	[SA] : No proposal chosen	172.101.30.73:500	172.100.30.80:500	IKE_LOG
info	IKE	[SA] : Tunnel [VPN_to_Cisco] Phase 2 proposal mismatch	172.101.30.73:500	172.100.30.80:500	IKE_LOG
info	IKE	Recv:[HASH][SA][NONCE][ID][ID]	172.100.30.80:500	172.101.30.73:500	IKE_LOG
info	IKE	Phase 1 IKE SA process done	172.101.30.73:500	172.100.30.80:500	IKE_LOG

Make sure the both ZyWALL/USG and Cisco security policies allow IPSec VPN traffic. IKE uses UDP port 500, AH uses IP protocol 51, and ESP uses IP protocol 50.

Default NAT traversal is enable on ZyWALL/USG, please make sure the remote IPSec device must also have NAT traversal enabled.

## How to Configure Site-to-site IPsec VPN with a SonicWALL router

This example shows how to use the VPN Setup Wizard to create a site-to-site VPN between a ZYWALL/USG and a SonicWALL router. The example instructs how to configure the VPN tunnel between each site. When the VPN tunnel is configured, each site can be accessed securely.

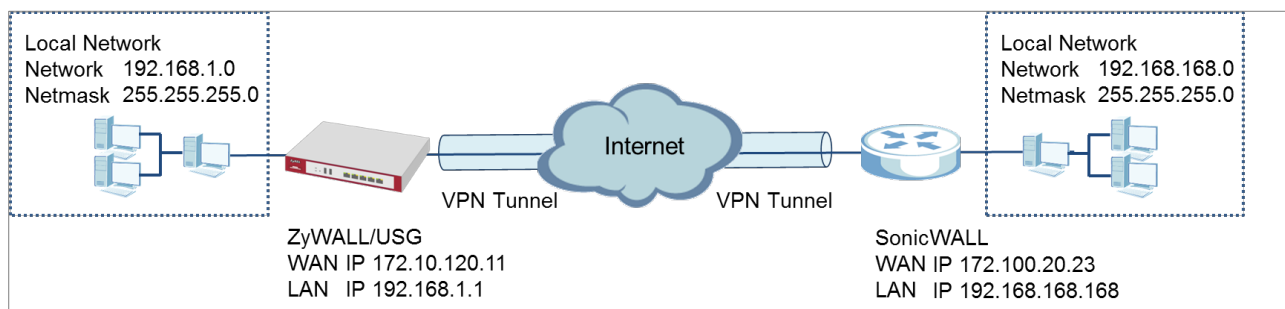

ZyWALL/USG Site-to-site IPsec VPN with SonicWALL

 Note: All network IP addresses and subnet masks are used as examples in this article. Please replace them with your actual network IP addresses and subnet masks. This example was tested using USG310 (Firmware Version: ZLD 4.25) and NSA240 (Firmware Version: SonicOS Enhanced 5.8.0.1-31o)

## Set Up the IPSec VPN Tunnel on the ZyWALL/USG

In the ZyWALL/USG, go to **Quick Setup > VPN Setup Wizard**, use the **VPN Settings** wizard to create a VPN rule that can be used with the SonicWALL. Click **Next**.

### Quick Setup > VPN Setup Wizard > Welcome

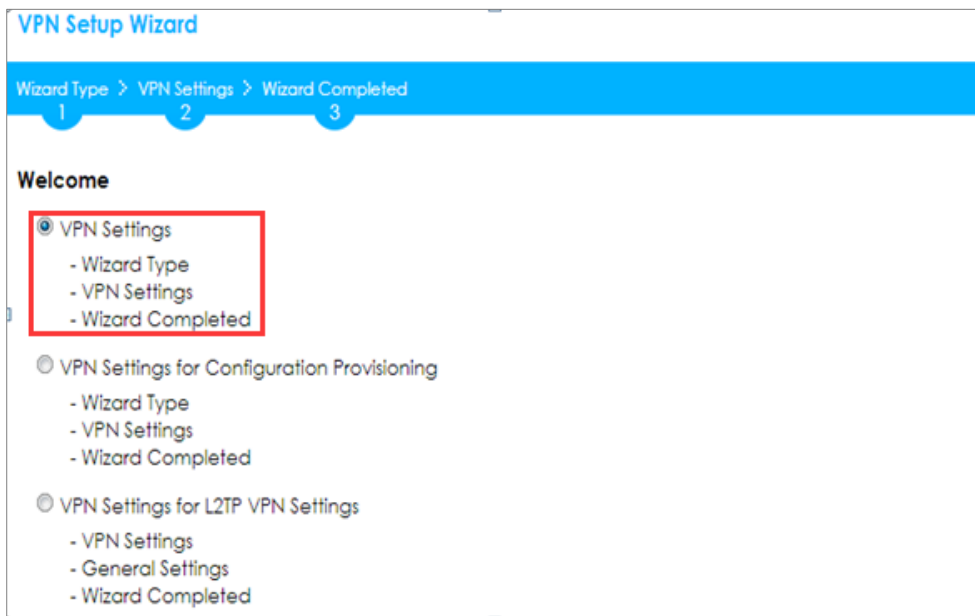

Choose **Advanced** to create a VPN rule with the customize phase 1, phase 2 settings and authentication method. Click **Next**.

### Quick Setup > VPN Setup Wizard > Welcome > Wizard Type

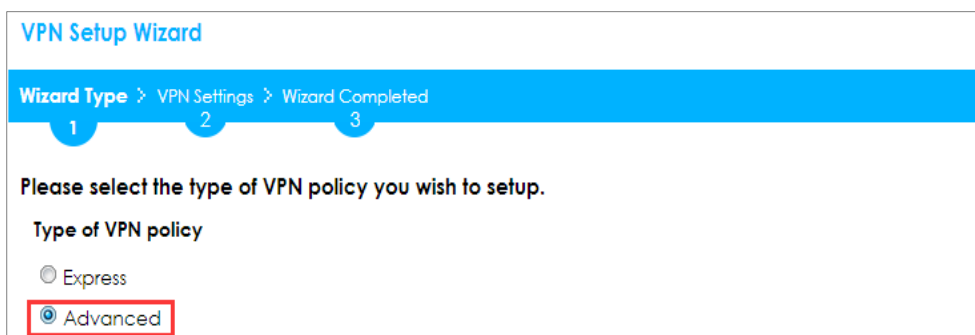

Type the **Rule Name** used to identify this VPN connection (and VPN gateway). You may use 1-31 alphanumeric characters. This value is case-sensitive. Select the rule to be **Site-to-site**. Click **Next**.

**Quick Setup > VPN Setup Wizard > Wizard Type > VPN Settings (Scenario)**

The screenshot shows the 'VPN Setup Wizard' interface. At the top, there is a breadcrumb trail: 'Wizard Type > VPN Settings > Wizard Completed'. Below this, there are three numbered steps: 1, 2, and 3. The main content area is titled 'Express Settings'. Under 'IKE Version', 'IKEv1' is selected. Under 'Scenario', the 'Rule Name' is 'VPN\_to\_SonicWALL' and 'Site-to-site' is selected. Other options include 'Site-to-site with Dynamic Peer', 'Remote Access (Server Role)', and 'Remote Access (Client Role)'.

Then, configure the **Secure Gateway** IP as the SonicWALL's Gateway IP address (in the example, 172.100.20.23); select **My Address** to be the interface connected to the Internet.

Set the desired **Negotiation**, **Encryption**, **Authentication**, **Key Group** and **SA Life Time** settings. Type a secure **Pre-Shared Key** (8-32 characters) which must match your SonicWALL **Shared Secret**.

**Quick Setup > VPN Setup Wizard > Welcome > Wizard Type > VPN Settings (Phase 1 Setting)**

**VPN Setup Wizard**

Wizard Type > **VPN Settings** > Wizard Completed

1      2      3

**Advanced Settings**

**Phase 1 Setting**

Secure Gateway:  (IP or FQDN)

My Address (interface):

Negotiation Mode:

Encryption Algorithm:

Authentication Algorithm:

Key Group:

SA Life Time:  (180 - 3000000 seconds)

NAT Traversal

Dead Peer Detection (DPD)

**Authentication Method**

Pre-Shared Key

Certificate

Continue to **Phase 2 Settings** to select the desired **Encapsulation**, **Encryption**, **Authentication**, and **SA Life Time** settings.

Set **Local Policy** to be the IP address range of the network connected to the ZyWALL/USG and **Remote Policy** to be the IP address range of the network connected to the SonicWALL. Click **OK**.

**Quick Setup > VPN Setup Wizard > Welcome > Wizard Type > VPN Settings (Phase 2 Setting)**

### VPN Setup Wizard

Wizard Type > **VPN Settings** > Wizard Completed

1 2 3

#### Advanced Settings

##### Phase 2 Setting

Active Protocol:

Encapsulation:

Encryption Algorithm:

Authentication Algorithm:

SA Life Time:  (180 - 3000000 seconds)

Perfect Forward Secrecy (PFS):

##### Policy Setting

Local Policy (IP/Mask):  /

Remote Policy (IP/Mask):  /

##### Property

Nailed-Up

This screen provides a read-only summary of the VPN tunnel. Click **Save**.

**Quick Setup > VPN Setup Wizard > Welcome > Wizard Type > VPN Settings (Summary)**

**VPN Setup Wizard**

Wizard Type > **VPN Settings** > Wizard Completed

1 2 3

**Advanced Settings**

**Summary**

Rule Name:	VPN_to_SonicWall
Secure Gateway:	172.100.20.23
Pre-Shared Key:	5k4u;4e.40fm06xk7187!
Local Policy (IP/Mask):	192.168.1.0 / 255.255.255.0
Remote Policy (IP/Mask):	192.168.168.0 / 255.255.255.0

**Phase 1**

Negotiation Mode:	main
Encryption Algorithm:	aes256
Authentication Algorithm:	sha
Key Group:	DH2

**Phase 2**

Active Protocol:	esp
Encapsulation:	tunnel
Encryption Algorithm:	aes128
Authentication Algorithm:	sha

 Note: The Phase 1 and Phase 2 settings established here must match the Phase 1 and Phase 2 settings configured later in the SonicWALL.

Now the rule is configured on the ZyWALL/USG. The Phase 1 rule settings appear in the **VPN > IPSec VPN > VPN Gateway** screen and the Phase 2 rule settings appear in the **VPN > IPSec VPN > VPN Connection** screen. Click **Close** to exit the wizard.

**Quick Setup > VPN Setup Wizard > Welcome > Wizard Type > VPN Settings > Wizard Completed**



**VPN Setup Wizard**

[Wizard Type](#) > [VPN Settings](#) > **Wizard Completed**

1
2
3

**Advanced Settings**

Congratulations. The VPN Access wizard is completed

Summary

Rule Name:	VPN_to_SonicWall
Secure Gateway:	172.100.20.23
My Address (interface):	ge1
Pre-Shared Key:	5k4u;4e.40fm06xk7187!

**Phase 1**

Negotiation Mode:	main
Encryption Algorithm:	aes256
Authentication Algorithm:	sha
Key Group:	DH2
SA Life Time:	86400
NAT Traversal:	true
Dead Peer Detection (DPD):	true

**Phase 2**

Active Protocol:	esp
Encapsulation:	tunnel
Encryption Algorithm:	aes128
Authentication Algorithm:	sha
SA Life Time:	86400
Perfect Forward Secrecy (PFS):	None

**Policy**

Local Policy (IP/Mask):	192.168.1.0 / 255.255.255.0
Remote Policy (IP/Mask):	192.168.168.0 / 255.255.255.0
Nailed-Up:	true

Go to **VPN Gateway > Show Advanced Settings > Authentication** to configure **your Local ID Type** and **Peer ID Type** to match your SonicWALL's **VPN > Settings > VPN Policies > General > IKE Authentication > Local IKE ID** and **Peer IKE ID**.

**VPN Gateway > Show Advanced Settings > Authentication**

**Authentication**

Pre-Shared Key

unmasked

Certificate  (See [My Certificates](#))

User Based PSK  ⓘ

▲ Advance

Local ID Type:

Content:

Peer ID Type:

Content:

## Set Up the IPSec VPN Tunnel on the SonicWALL

In the SonicWALL **VPN > Settings > VPN Policies**, click **Add** to create a new VPN policy. Select **Policy Type** to be the **Site to Site**, select **Authentication Method** to

be the **IKE using Preshared Secret**. Type the ZyWALL/USG's WAN IP Address to be the **IPsec Primary Gateway Name or Address** (in the example, 172.10.120.11).

In the **IKE Authentication** section, set the **Shared Secret** to be the same as your ZyWALL/USG's **Pre-Shared Key**. Then, set the **Local IKE ID** and the **Peer IKE ID** to match your ZyWALL/USG's **VPN Gateway > Show Advanced Settings > Authentication > Local ID Type** and **Peer ID Type**.

**VPN > Settings > VPN Policies > General**

**SONICWALL** | Network Security Appliance

General | Network | Proposals | Advanced

**Security Policy**

Policy Type: Site to Site

Authentication Method: IKE using Preshared Secret

Name: VPN\_to\_ZyWALL

IPsec Primary Gateway Name or Address: 172.10.120.11

IPsec Secondary Gateway Name or Address: 0.0.0.0

**IKE Authentication**

Shared Secret: 5k4u;4e.40fm06xk7187!

Confirm Shared Secret: 5k4u;4e.40fm06xk7187!  Mask Shared Secret

Local IKE ID: IP Address 192.168.168.0

Peer IKE ID: IP Address 192.168.1.0

In the SonicWALL **VPN > Settings > VPN Policies > Network**, choose **Local Network** to be the IP address range of the network connected to the **SonicWALL** (found under **SonicWALL > Network > Interfaces > LAN**).

Go to **Remote Network** and create a new address IP address range of the network connected to the ZyWALL/USG. Then, scroll down the list to choose the newly created **Address Object** to be the **Remote Network**.

## VPN > Settings > VPN Policies > Network

The screenshot shows the SonicWall Network Security Appliance interface. The top navigation bar includes 'General', 'Network', 'Proposals', and 'Advanced'. The 'Network' tab is selected. Under 'Local Networks', there are three radio button options: 'Choose local network from list' (selected), 'Local network obtains IP addresses using DHCP through', and 'Any address'. A dropdown menu is open for 'Choose local network from list', showing options: '--Select Local Network--', '==== Address Objects ====', 'X0 IP', 'X0 Subnet' (highlighted in red), 'X1 Default Gateway', 'X1 IP', and '==== Address Objects ===='. Below this is the 'Remote Networks' section with three radio button options: 'Use this VPN Tunnel as default route for all Internet traffic', 'Destination network obtains IP addresses using DHCP through this VPN Tunnel', and 'Choose destination network from list' (selected). A callout box points to a 'Create new address object...' option in the 'Choose destination network from list' dropdown. The callout box contains a form for creating a new address object with fields for Name (ZyWALL), Zone Assignment (LAN), Type (Network), Network (192.168.1.0), and Netmask (255.255.255.0). The dropdown menu in the callout shows options: '--Select Remote Network--', '--Select Remote Network--', 'Create new address object...' (highlighted in red), 'Create new address group...', '==== Address Groups ====', 'allIP', 'relayagent', '==== Address Objects ====', and 'ZyWALL' (highlighted in red).

This is a close-up of the 'Remote Networks' section. It shows the three radio button options: 'Use this VPN Tunnel as default route for all Internet traffic', 'Destination network obtains IP addresses using DHCP through this VPN Tunnel', and 'Choose destination network from list' (selected). A dropdown menu is open for 'Choose destination network from list', showing options: 'ZyWALL' (highlighted in red), '--Select Remote Network--', 'Create new address object...', 'Create new address group...', '==== Address Groups ====', 'allIP', 'relayagent', '==== Address Objects ====', and 'ZyWALL' (highlighted in red).

In the SonicWALL **VPN > Settings > VPN Policies > Proposals > IKE (Phase 1) Proposal** and set **Exchange, DH Group, Encryption** and **Authentication** to match your ZyWALL/USG's **VPN Gateway > Show Advanced Settings > Phase 1 Settings**.

Go to **IKE (Phase 2) Proposal** and set the **Protocol, Encryption** and **Authentication** to match your ZyWALL/USG's **VPN Connection > Show Advanced Settings > Phase 2 Settings**.

**VPN > Settings > VPN Policies > Proposals**

The screenshot displays the SonicWALL Network Security Appliance web interface. At the top, the 'SONICWALL Network Security Appliance' logo is visible. Below the logo, there are four tabs: 'General', 'Network', 'Proposals', and 'Advanced'. The 'Proposals' tab is selected and highlighted with a red border. Underneath, the 'IKE (Phase 1) Proposal' section is expanded, showing the following settings:

- Exchange: Main Mode (dropdown menu)
- DH Group: Group 2 (dropdown menu)
- Encryption: AES-256 (dropdown menu)
- Authentication: SHA1 (dropdown menu)
- Life Time (seconds): 28800 (text input field)

Below the IKE section, the 'Ipssec (Phase 2) Proposal' section is also visible, showing the following settings:

- Protocol: ESP (dropdown menu)
- Encryption: AES-128 (dropdown menu)
- Authentication: SHA1 (dropdown menu)
- Enable Perfect Forward Security (checkbox)
- Life Time (seconds): 28800 (text input field)

Select **Enable VPN** and click **Refresh Active**.

**VPN > Settings > VPN Global Settings**

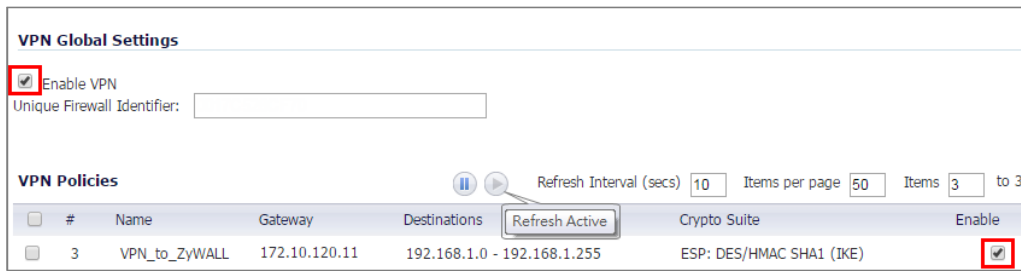

## Test the IPSec VPN Tunnel

Go to ZyWALL/USG **CONFIGURATION > VPN > IPSec VPN > VPN Connection**, click **Connect** on the upper bar. The **Status** connect icon is lit when the interface is connected.

### CONFIGURATION > VPN > IPSec VPN > VPN Connection

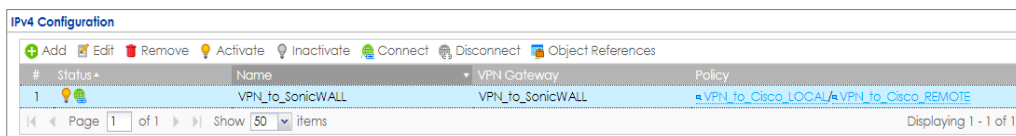

Go to ZyWALL/USG **MONITOR > VPN Monitor > IPSec** and verify the tunnel **Up Time** and the **Inbound(Bytes)/Outbound(Bytes)** traffic.

### MONITOR > VPN Monitor > IPSec

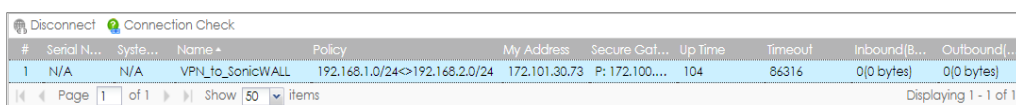

Go to SonicWALL **VPN > VPN Settings > VPN Policies**, the status green light is on.

### VPN > VPN Settings > VPN Policies

#	Name	Gateway	Destinations	Crypto Suite	Enable
1	VPN_to_ZyWALL	172.10.120.11	192.168.1.0 - 192.168.1.255	ESP: AES-128/HMAC SHA1 (IKE)	<input checked="" type="checkbox"/>

Go to SonicWALL **VPN > VPN Settings > Currently Active VPN Tunnels > VPN Tunnel Statics** to check **Tunnel valid time**, **Bytes In** (Incoming Data) and **Bytes Out** (Outgoing Data).

### VPN > VPN Settings > Currently Active VPN Tunnels

#	Created	Name	Local	Remote	Gateway	Actions
1	10/04/2015 15:07:06	VPN_to_ZyWALL	192.168.168.0 - 192.168.168.255	192.168.1.0 - 192.168.1.255	172.10.120.11	Renegotiate

**VPN Tunnel Statistics**

Create Time: 10/04/2015 15:07:06

Tunnel valid until: 10/04/2015 23:07:06

Packets In: 378

Packets Out: 370

Bytes In: 20080

Bytes Out: 16640

Fragments In: 0

Fragments Out: 0

To test whether a tunnel is working, ping from a computer at one site to a computer at the other. Ensure that both computers have Internet access (via the IPSec devices).

**PC behind ZyWALL/USG > Window 7 > cmd > ping 192.168.168.33**

```
C:\Documents and Settings\ZyXEL>ping 192.168.168.33

Pinging 192.168.168.33 with 32 bytes of data:

Reply from 192.168.168.33: bytes=32 time=18ms TTL=54
Reply from 192.168.168.33: bytes=32 time=17ms TTL=54
Reply from 192.168.168.33: bytes=32 time=17ms TTL=54
Reply from 192.168.168.33: bytes=32 time=16ms TTL=54

Ping statistics for 192.168.168.33:
    Packets: Sent = 4, Received = 4, Lost = 0 (0% loss),
Approximate round trip times in milli-seconds:
    Minimum = 16ms, Maximum = 18ms, Average = 17ms
```

PC behind SonicWALL> Window 7 > cmd > ping 192.168.1.33

```
C:\Documents and Settings\ZyXEL>ping 192.168.1.33

Pinging 192.168.1.33 with 32 bytes of data:

Reply from 192.168.1.33: bytes=32 time=27ms TTL=43
Reply from 192.168.1.33: bytes=32 time=32ms TTL=43
Reply from 192.168.1.33: bytes=32 time=26ms TTL=43
Reply from 192.168.1.33: bytes=32 time=27ms TTL=43

Ping statistics for 192.168.1.33:
    Packets: Sent = 4, Received = 4, Lost = 0 (0% loss),
Approximate round trip times in milli-seconds:
    Minimum = 26ms, Maximum = 32ms, Average = 28ms
```

## What Could Go Wrong?

If you see below [info] or [error] log message, please check ZyWALL/USG Phase 1 Settings. Both ZyWALL/USG and SonicWALL must use the same Pre-Shared Key, Encryption, Authentication method, DH key group and ID Type to establish the IKE SA.

**MONITOR > Log**



Priority	Category	Message	Source	Destination	Note
info	IKE	Send:[HASH][NOTIFY:NO_PROPOSAL_CHOSEN]	172.101.30.73:...	172.100.30.80:...	IKE_LOG
info	IKE	[SA] : No proposal chosen	172.101.30.73:...	172.100.30.80:...	IKE_LOG
info	IKE	[SA] : Tunnel [VPN_to_SonicWALL] Phase 1 proposal mismatch	172.101.30.73:...	172.100.30.80:...	IKE_LOG

If you see that Phase 1 IKE SA process done but still get below [info] log message, please check ZyWALL/USG and SonicWALL Phase 2 Settings. Both ZyWALL/USG and SonicWALL must use the same Protocol, Encapsulation, Encryption, Authentication method and PFS to establish the IKE SA.

### MONITOR > Log

Priority	Category	Message	Source	Destination	Note
info	IKE	Send:[HASH][NOTIFY:NO_PROPOSAL_CHOSEN]	172.101.30.73:...	172.100.30.80:...	IKE_LOG
info	IKE	[SA] : No proposal chosen	172.101.30.73:...	172.100.30.80:...	IKE_LOG
info	IKE	[SA] : Tunnel [VPN_to_SonicWALL] Phase 2 proposal mismatch	172.101.30.73:...	172.100.30.80:...	IKE_LOG
info	IKE	Recv:[HASH][SA][NONCE][ID][ID]	172.100.30.80:...	172.101.30.73:...	IKE_LOG
info	IKE	Phase 1 IKE SA process done	172.101.30.73:...	172.100.30.80:...	IKE_LOG

Make sure the both ZyWALL/USG and SonicWALL security policies allow IPSec VPN traffic. IKE uses UDP port 500, AH uses IP protocol 51, and ESP uses IP protocol 50.

Default NAT traversal is enable on ZyWALL/USG, please make sure the remote IPSec device must also have NAT traversal enabled.

**ZYXEL**

[www.zyxel.com](http://www.zyxel.com)

## How to Configure IPsec VPN Failover

This example shows how to use the VPN Setup Wizard to create a site-to-site VPN with failover. The example instructs how to configure the VPN tunnel between each site if one site has multi-WAN. When the multi-WAN VPN failover is configured, IPsec VPN tunnels automatically fail over to a backup WAN interface if the primary WAN interface becomes unavailable.

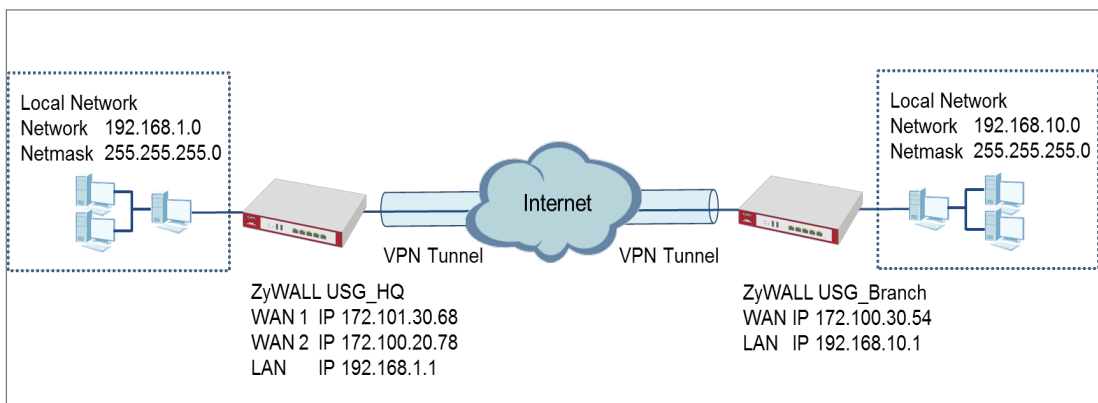

ZyWALL Site-to-site IPsec VPN with multiple WAN failover

 Note: All network IP addresses and subnet masks are used as examples in this article. Please replace them with your actual network IP addresses and subnet masks. This example was tested using USG110 (Firmware Version: ZLD 4.25).

## Set Up the ZyWALL/USG IPsec VPN Tunnel of Corporate Network (HQ)

In the ZyWALL/USG, go to **Quick Setup > VPN Setup Wizard**, use the **VPN Settings** wizard to create a VPN rule that can be used with the remote ZyWALL/USG. Click **Next**.

### Quick Setup > VPN Setup Wizard > Welcome

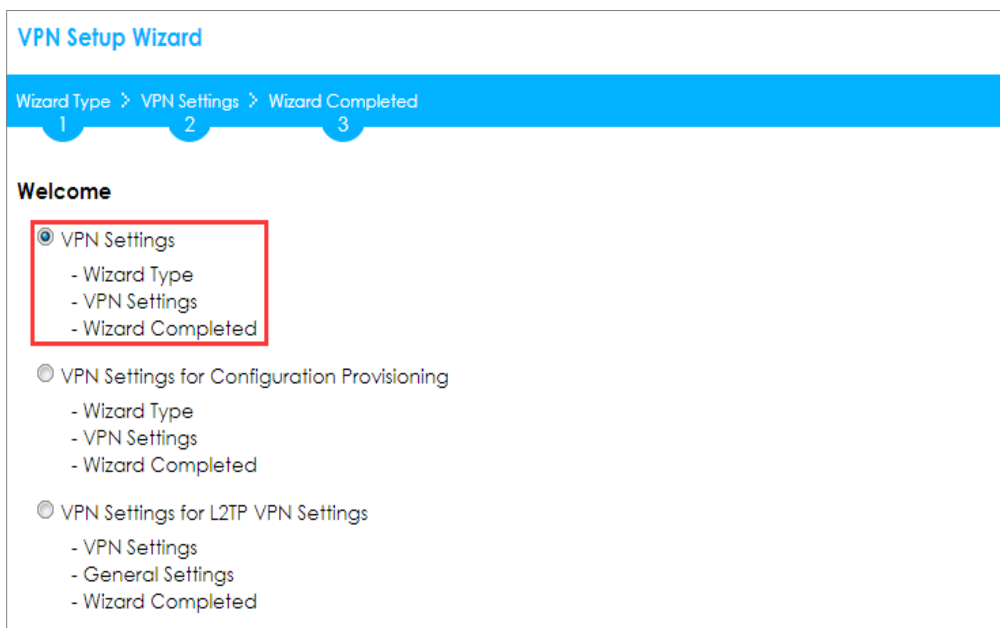

Choose **Express** to create a VPN rule with the default phase 1 and phase 2 settings and use a pre-shared key to be the authentication method. Click **Next**.

### Quick Setup > VPN Setup Wizard > Wizard Type

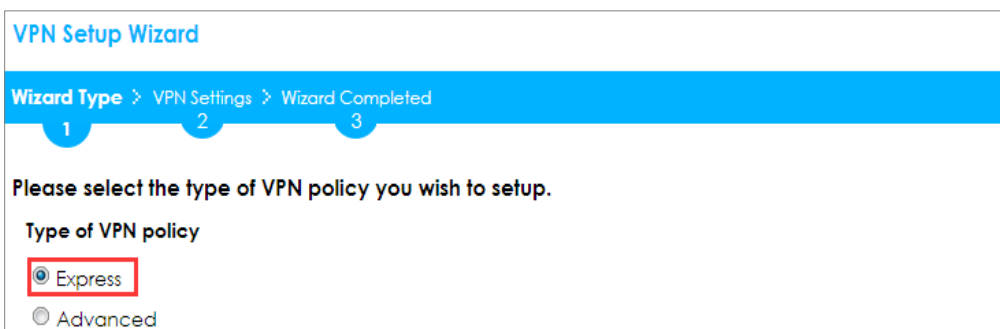

Type the **Rule Name** used to identify this VPN connection (and VPN gateway). You may use 1-31 alphanumeric characters. This value is case-sensitive. Select the rule to be **Site-to-site**. Click **Next**.

**Quick Setup > VPN Setup Wizard > Wizard Type > VPN Settings (Scenario)**

**VPN Setup Wizard**

Wizard Type > **VPN Settings** > Wizard Completed

1 2 3

**Express Settings**

**IKE Version**

IKEv1

IKEv2

**Scenario**

Rule Name:

Site-to-site

Site-to-site with Dynamic Peer

Remote Access (Server Role)

Remote Access (Client Role)

Configure **Secure Gateway** IP as the peer ZyWALL/USG's WAN IP address (in the example, 172.100.30.54). Type a secure **Pre-Shared Key** (8-32 characters).

Set **Local Policy** to be the IP address range of the network connected to the ZyWALL/USG and **Remote Policy** to be the IP address range of the network connected to the peer ZyWALL/USG.

**Quick Setup > VPN Setup Wizard > Wizard Type > VPN Settings (Configuration)**

### VPN Setup Wizard

Wizard Type > VPN Settings > Wizard Completed

1
2
3

#### Express Settings

**Configuration**

Secure Gateway:	172.100.30.54	(IP or FQDN)
Pre-Shared Key:	ZyXEL123	
Local Policy (IP/Mask):	192.168.1.0	/255.255.255.0
Remote Policy (IP/Mask):	192.168.10.0	/255.255.255.0

This screen provides a read-only summary of the VPN tunnel. Click **Save**.

**Quick Setup > VPN Setup Wizard > Welcome > Wizard Type > VPN Settings (Summary)**

### VPN Setup Wizard

Wizard Type > VPN Settings > Wizard Completed

1
2
3

#### Express Settings

**Summary**

Rule Name:	WIZ_VPN_HQ	
Secure Gateway:	172.100.30.54	
Pre-Shared Key:	ZyXEL123	
Local Policy (IP/Mask):	192.168.1.0 / 255.255.255.0	
Remote Policy (IP/Mask):	192.168.10.0 / 255.255.255.0	

Now the rule is configured on the ZyWALL/USG. The Phase 1 rule settings appear in the **VPN > IPSec VPN > VPN Gateway** screen and the Phase 2 rule settings appear in the **VPN > IPSec VPN > VPN Connection** screen. Click **Close** to exit the wizard.

**Quick Setup > VPN Setup Wizard > Welcome > Wizard Type > VPN Settings > Wizard Completed**

**VPN Setup Wizard**

[Wizard Type](#) > [VPN Settings](#) > **Wizard Completed**

1
2
3

**Express Settings**

Congratulations. The VPN Access wizard is completed

Summary

Rule Name:	WIZ_VPN_HQ
Secure Gateway:	172.100.30.54
Pre-Shared Key:	ZyXEL123
Local Policy (IP/Mask):	192.168.1.0 / 255.255.255.0
Remote Policy (IP/Mask):	192.168.10.0 / 255.255.255.0

Go to **CONFIGURATION > VPN > IPSec VPN > VPN Gateway** and click **Show Advanced Settings**. Configure **Authentication > Peer ID Type** as **Any** to let the ZyWALL/USG does not require to check the identity content of the remote IPSec router.

**CONFIGURATION > VPN > IPSec VPN > VPN Gateway > Show Advanced Settings > Authentication > Peer ID Type**

**Authentication**

Pre-Shared Key

unmasked

Certificate  (See [My Certificates](#))

User Based PSK  ⓘ

⊕ Advance

Local ID Type:

Content:

Peer ID Type: Any

Content:

## Set Up the ZyWALL/USG IPSec VPN Tunnel of Corporate Network (Branch)

In the ZyWALL/USG, go to **Quick Setup > VPN Setup Wizard**, use the **VPN Settings** wizard to create a VPN rule that can be used with the remote ZyWALL/USG. Click **Next**.

## Quick Setup > VPN Setup Wizard > Welcome

**VPN Setup Wizard**

Wizard Type > VPN Settings > Wizard Completed

1 2 3

**Welcome**

- VPN Settings
  - Wizard Type
  - VPN Settings
  - Wizard Completed
- VPN Settings for Configuration Provisioning
  - Wizard Type
  - VPN Settings
  - Wizard Completed
- VPN Settings for L2TP VPN Settings
  - VPN Settings
  - General Settings
  - Wizard Completed

Choose **Express** to create a VPN rule with the default phase 1 and phase 2 settings and to use a pre-shared key. Click **Next**.

## Quick Setup > VPN Setup Wizard > Wizard Type

**VPN Setup Wizard**

Wizard Type > VPN Settings > Wizard Completed

1 2 3

**Please select the type of VPN policy you wish to setup.**

**Type of VPN policy**

- Express
- Advanced

Type the **Rule Name** used to identify this VPN connection (and VPN gateway). You may use 1-31 alphanumeric characters. This value is case-sensitive. Click **Next**.



**Quick Setup > VPN Setup Wizard > Wizard Type > VPN Settings (Scenario)**

**VPN Setup Wizard**

Wizard Type > **VPN Settings** > Wizard Completed  
1 2 3

**Express Settings**

**IKE Version**

IKEv1  
 IKEv2

**Scenario**

Rule Name:

Site-to-site  
 Site-to-site with Dynamic Peer  
 Remote Access (Server Role)  
 Remote Access (Client Role)

Configure **Secure Gateway** IP as the peer ZyWALL/USG's WAN IP address (in the example, 172.101.30.68). Type a secure **Pre-Shared Key** (8-32 characters).

Set **Local Policy** to be the IP address range of the network connected to the ZyWALL/USG and **Remote Policy** to be the IP address range of the network connected to the peer ZYWALL/USG.

**Quick Setup > VPN Setup Wizard > Wizard Type > VPN Settings (Configuration)**

**VPN Setup Wizard**

Wizard Type > **VPN Settings** > Wizard Completed  
1 2 3

**Express Settings**

**Configuration**

Secure Gateway:  (IP or FQDN)

Pre-Shared Key:

Local Policy (IP/Mask):  /

Remote Policy (IP/Mask):  /

This screen provides a read-only summary of the VPN tunnel. Click **Save**.

**Quick Setup > VPN Setup Wizard > Welcome > Wizard Type > VPN Settings (Summary)**

**VPN Setup Wizard**

[Wizard Type](#) > [VPN Settings](#) > [Wizard Completed](#)

**Express Settings**

**Summary**

Rule Name:	WIZ_VPN_Branch
Secure Gateway:	172.101.30.68
Pre-Shared Key:	ZyXEL123
Local Policy (IP/Mask):	192.168.10.0 / 255.255.255.0
Remote Policy (IP/Mask):	192.168.1.0 / 255.255.255.0

Now the rule is configured on the ZyWALL/USG. The Phase 1 rule settings appear in the **VPN > IPSec VPN > VPN Gateway** screen and the Phase 2 rule settings appear in the **VPN > IPSec VPN > VPN Connection** screen. Click **Close** to exit the wizard.

**Quick Setup > VPN Setup Wizard > Welcome > Wizard Type > VPN Settings > Wizard Completed**

**VPN Setup Wizard**

[Wizard Type](#) > [VPN Settings](#) > [Wizard Completed](#)

**Express Settings**

Congratulations. The VPN Access wizard is completed

**Summary**

Rule Name:	WIZ_VPN_Branch
Secure Gateway:	172.101.30.68
Pre-Shared Key:	ZyXEL123
Local Policy (IP/Mask):	192.168.10.0 / 255.255.255.0
Remote Policy (IP/Mask):	192.168.1.0 / 255.255.255.0

Go to **CONFIGURATION > VPN > IPSec VPN > VPN Gateway** and click **Show Advanced Settings**. **Configure Authentication > Peer ID Type** as **Any** to let the ZyWALL/USG does not require to check the identity content of the remote IPSec router.

**CONFIGURATION > VPN > IPSec VPN > VPN Gateway > Show Advanced Settings > Authentication > Peer ID Type**

**Authentication**

Pre-Shared Key   
 unmasked

Certificate  (See [My Certificates](#))

User Based PSK  ⓘ

▲ **Advance**

Local ID Type:

Content:

Peer ID Type:

Content:

Go to **Configuration > VPN > IPSec VPN > VPN Gateway > Gateway Settings**. Set **My Address** to be **Domain Name/IP** "0.0.0.0" (ZyWALL/USG will dial-up with the active WAN interface first). Set **Peer Gateway Address > Static Address > Primary** to be ZyWALL/USG\_HQ WAN1 IP address and **Secondary** to be ZyWALL/USG\_HQ WAN2 IP address.

Configuration > VPN > IPSec VPN > VPN Gateway > Gateway Settings

**General Settings**

Enable

VPN Gateway Name:

**IKE Version**

IKEv1

IKEv2

**Gateway Settings**

**My Address**

Interface  Static -- 0.0.0.0/0.0.0.0

Domain Name / IPv4

**Peer Gateway Address**

Static Address ⓘ

Primary

Secondary

Fall back to Primary Peer Gateway when possible

Fall Back Check Interval:  (60-86400 seconds)

Dynamic Address ⓘ

## Set up the WAN Trunk (ZyWALL/USG\_HQ)

Go to **CONFIGURATION > Interface > Trunk > User Configuration > Add**. Select wan1 and wan2 into the trunk **Member** and set wan2 **Mode** to be **Passive**.

**CONFIGURATION > Interface > Trunk > User Configuration > Add**

**+ Add Trunk**

Name: Multi\_WAN\_Failover

Load Balancing Algorithm: Least Load First

Load Balancing Index(es): Outbound

#	Member	Mode	Egress Bandwidth
1	wan1	Active	1048576 kbps
2	wan2	Passive	1048576 kbps

Page 0 of 0 Show 50 items No data to display

OK Cancel

Go to **CONFIGURATION > Interface > Trunk > Configuration**. Select **Disconnect Connection before Falling Back**. In the **Default WAN Trunk**, select **User Configured Trunk** to be the customized WAN trunk added in the previous step (Multi\_WAN\_Failover in this example).

**CONFIGURATION > Interface > Trunk > User Configuration > Add**

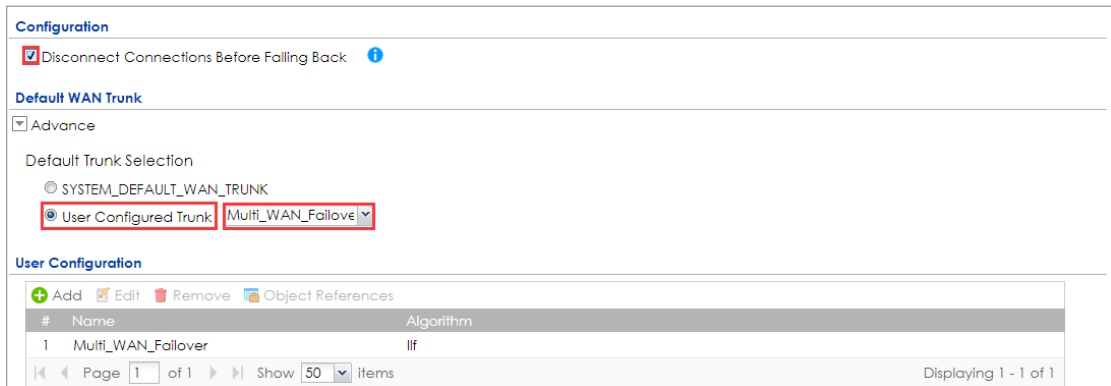

## Set up the Failover Command Line (ZyWALL/USG HQ)

Go to **CONFIGURATION > Security Policy > Policy Control** and add a **To ZyWALL** rule to allow **SSH** service.

**CONFIGURATION > Security Policy > Policy Control > Add corresponding**

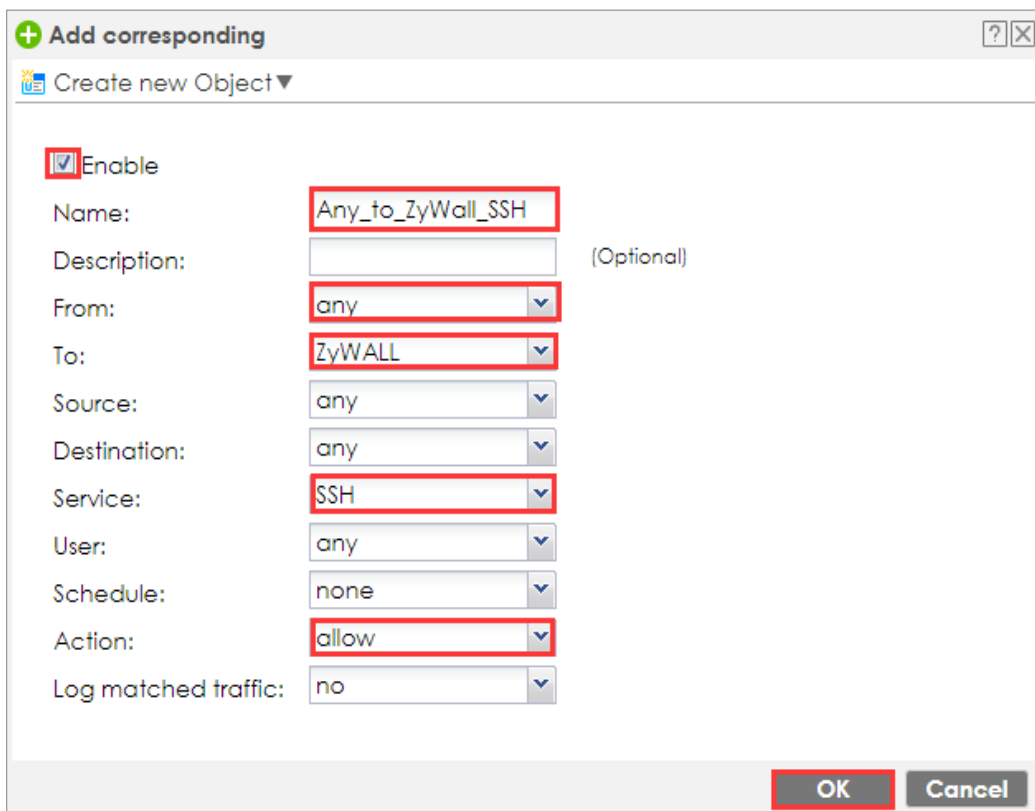

If the **Security Policy** is created but still cannot access to ZyWALL, please go to **CONFIGURAITON > System > SSH** to check do you **Enable** the **General Settings** and make sure the **Service Port** is correct and the same in your terminal program. Then, check the **Service Control Action** should be **Accept**.

## CONFIGURAITON > System > SSH

**General Settings**

Enable

Version 1

Server Port:

Server Certificate:

**Service Control**

#	Zone	Address	Action
-	ALL	ALL	Accept

Page 1 of 1 | Show 50 items | Displaying 1 - 1 of 1

Enter the command line in terminal mode (Using Tera Term in this example).

### Tera Term command

```

Welcome to USG110

Username: admin
Password:
Router> configure terminal
Router(config)# client-side-vpn-failover-fallback activate
    
```

## Test the IPSec VPN Tunnel

- Go to ZYWALL/USG **CONFIGURATION > VPN > IPSec VPN > VPN Connection**, click **Connect** on the upper bar. The **Status** connect icon is lit when the interface is connected.

### CONFIGURATION > VPN > IPSec VPN > VPN Connection

**IPv4 Configuration**

#	Status	Name	VPN Gateway	Policy
1		WIZ_VPN_HQ	WIZ_VPN_HQ	VPN_to_Cisco_LOCAL/VPN_to_Cisco_REMOTE

Page 1 of 1 | Show 50 items | Displaying 1 - 1 of 1



## What Could Go Wrong?

- 11** If you see below [info] or [error] log message, please check ZyWALL/USG Phase 1 Settings. Both ZyWALL/USG at the HQ and Branch sites must use the same Pre-Shared Key, Encryption, Authentication method, DH key group and ID Type to establish the IKE SA.

### MONITOR > Log

Priority	Category	Message	Note
info	IKE	Send:[NOTIFY:NO_PROPOSAL_CHOSEN]	IKE_LOG
info	IKE	[SA] : No proposal chosen	IKE_LOG
info	IKE	[SA] : Tunnel [WIZ_VPN_HQ] Phase 1 proposal mismatch	IKE_LOG

- 12** If you see that Phase 1 IKE SA process done but still get below [info] log message, please check ZyWALL/USG Phase 2 Settings. Both ZyWALL/USG at the HQ and Branch sites must use the same Protocol, Encapsulation, Encryption, Authentication method and PFS to establish the IKE SA.

### MONITOR > Log

Priority	Category	Message	Note
info	IKE	Send:[HASH][NOTIFY:NO_PROPOSAL_CHOSEN]	IKE_LOG
info	IKE	[SA] : No proposal chosen	IKE_LOG
info	IKE	[SA] : Tunnel [WIZ_VPN_HQ] Phase 2 proposal mismatch	IKE_LOG
info	IKE	Recv:[HASH][SA][NONCE][ID][ID]	IKE_LOG
info	IKE	Phase 1 IKE SA process done	IKE_LOG

- 13** Make sure the both ZyWALL/USG at the HQ and Branch sites security policies allow IPSec VPN traffic. IKE uses UDP port 500, AH uses IP protocol 51, and ESP uses IP protocol 50.
- 14** Default NAT traversal is enable on ZyWALL/USG, please make sure the remote IPSec device must also have NAT traversal enabled.



**ZYXEL**

[www.zyxel.com](http://www.zyxel.com)

## How to Configure L2TP over IPsec VPN while the ZyWALL/USG is behind a NAT router

This example shows how to use the VPN Setup Wizard to create a L2TP over IPsec VPN tunnel between ZyWALL/USG devices. The example instructs how to configure the VPN tunnel between each site while the ZyWALL/USG is behind a NAT router. When the L2TP over IPsec VPN tunnel is configured, each site can be accessed securely.

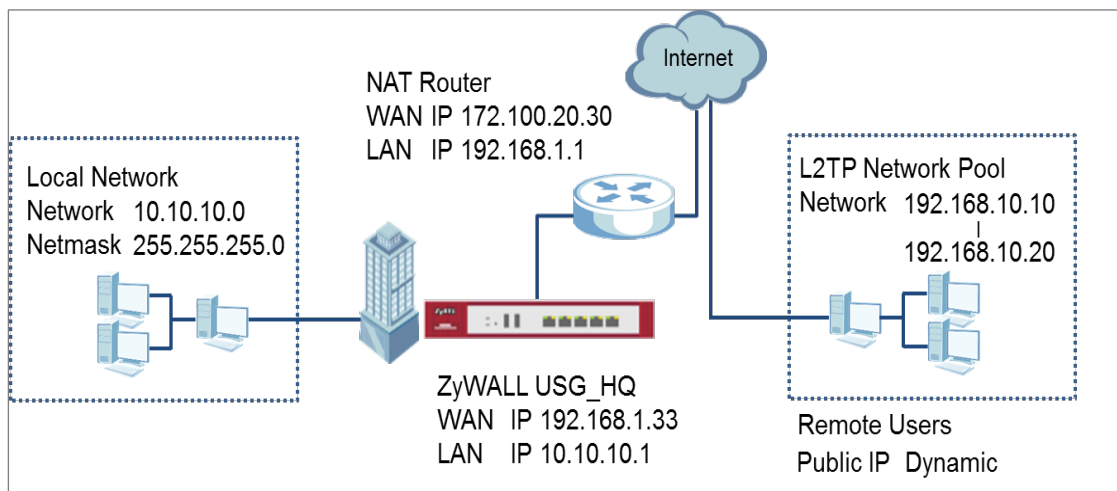

ZyWALL/USG L2TP over IPsec VPN while the ZyWALL/USG is behind a NAT router

### Note:

All network IP addresses and subnet masks are used as examples in this article. Please replace them with your actual network IP addresses and subnet masks. This example was tested using USG110 (Firmware Version: ZLD 4.25).

## Set Up the L2TP VPN Tunnel on the ZyWALL/USG\_HQ

In the ZyWALL/USG, go to **Quick Setup > VPN Setup Wizard**, use the **VPN Settings for L2TP VPN Settings** wizard to create a **L2TP VPN** rule that can be used with the remote Android Mobile Devices. Click **Next**.

### Quick Setup > VPN Setup Wizard > Welcome

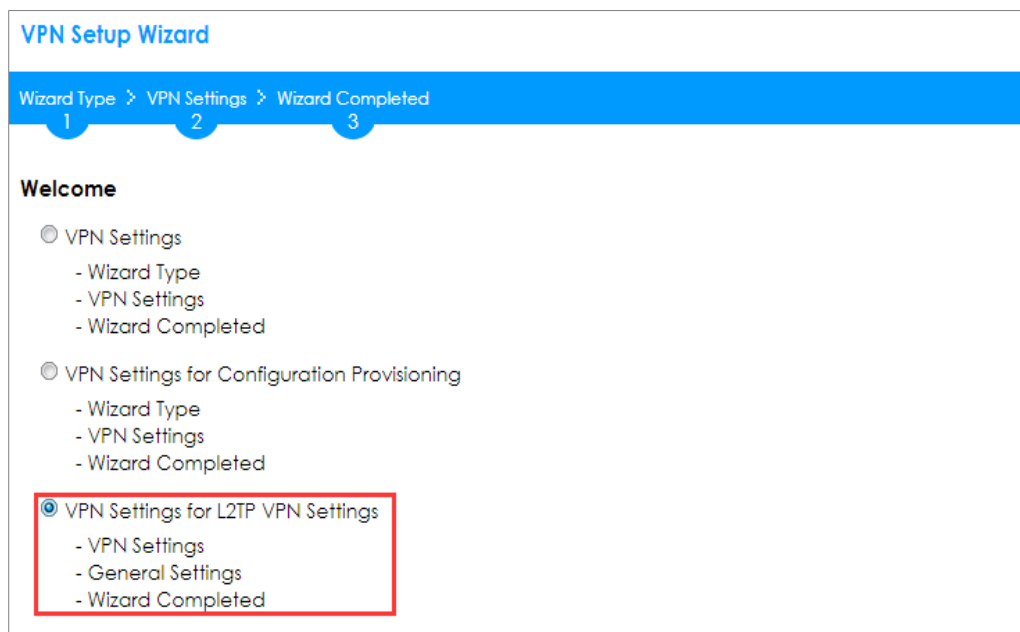

Then, configure the **Rule Name** and set **My Address** to be the **wan1** interface which is connected to the Internet. Type a secure **Pre-Shared Key** (8-32 characters).

### Quick Setup > VPN Setup Wizard > Welcome > VPN Settings

**VPN Setup Wizard**

VPN Settings > General Settings > Wizard Completed

1      2      3

**L2TP VPN Settings**

Rule Name:

**Phase 1 Setting**

My Address (interface):

**Authentication Method**

Pre-Shared Key:

Assign the remote users IP addresses range from 192.168.10.10 to 192.168.10.20 for use in the L2TP VPN tunnel and check **Allow L2TP traffic Through WAN** to allow traffic from L2TP clients to go to the Internet. Click **Next**.

**Quick Setup > VPN Setup Wizard > Welcome > VPN Settings (L2TP VPN Settings)**

**VPN Setup Wizard**

VPN Settings > General Settings > Wizard Completed

1      2      3

**L2TP VPN Settings**

IP Address Pool:  ⓘ

Starting IP Address:

End IP Address:

First DNS Server (Optional):

Second DNS Server (Optional):

Allow L2TP traffic Through WAN

**15** This screen provides a read-only summary of the VPN tunnel. Click **Save**.

**Quick Setup > VPN Setup Wizard > Welcome > VPN Settings (Summary)**

**VPN Setup Wizard**

[Wizard Type](#) > [VPN Settings](#) > [Wizard Completed](#)

1
2
3

**Express Settings**

**Summary**

Rule Name:	WIZ_L2TP_VPN
Secure Gateway:	Any
Pre-Shared Key:	xyz12345
My Address (interface):	wan1
IP Address Pool:	RANGE, 192.168.10.10 - 192.168.10.20

Now the rule is configured on the ZyWALL/USG. The rule settings appear in the **VPN > L2TP VPN** screen. Click **Close** to exit the wizard.

**Quick Setup > VPN Setup Wizard > Welcome > VPN Settings > Wizard Completed**

**VPN Setup Wizard**

[Wizard Type](#) > [VPN Settings](#) > [Wizard Completed](#)

1
2
3

**L2TP VPN Settings**

Congratulations. The VPN Access wizard is completed

**Summary**

Rule Name:	WIZ_L2TP_VPN
My Address (interface):	wan1
Pre-Shared Key:	xyz12345
IP Address Pool:	RANGE, 192.168.10.10 - 192.168.10.20

Go to **CONFIGURATION > VPN Connection > Create new Object > Create Address**, create an address object as the NAT router's WAN IP address (in the example, 172.100.20.30).

**CONFIGURATION > VPN Connection > Create new Object > Create Address**



The image shows a dialog box titled "Add Address Rule". It contains three input fields: "Name" with the value "NAT\_WAN\_IP", "Address Type" with a dropdown menu set to "HOST", and "IP Address" with the value "172.100.20.30". Each of these three fields is highlighted with a red rectangular border. At the bottom right of the dialog box, there are two buttons: "OK" and "Cancel".

Go to **CONFIGURATION > VPN Connection > Policy > Local Policy**, select it be to the NAT router's WAN IP address (in the example, 172.100.20.30).

## CONFIGURATION > VPN Connection > Policy > Local Policy

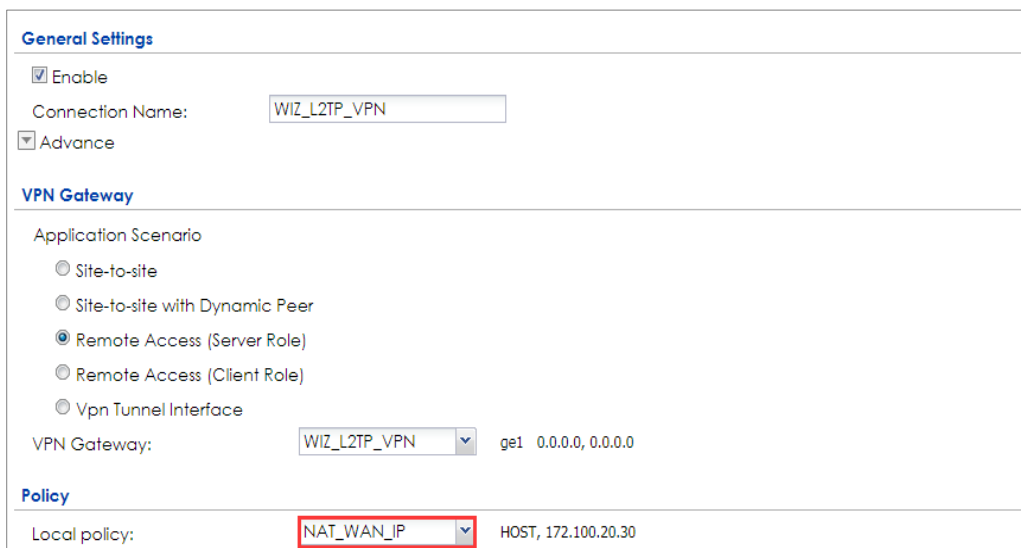

The image shows the configuration page for a VPN connection policy. It is divided into three sections: "General Settings", "VPN Gateway", and "Policy".

- General Settings:** Includes a checked "Enable" checkbox, a "Connection Name" field with the value "WIZ\_L2TP\_VPN", and a checked "Advance" checkbox.
- VPN Gateway:** Includes an "Application Scenario" section with radio buttons for "Site-to-site", "Site-to-site with Dynamic Peer", "Remote Access (Server Role)" (which is selected), "Remote Access (Client Role)", and "Vpn Tunnel Interface". Below this is a "VPN Gateway" field with a dropdown menu set to "WIZ\_L2TP\_VPN" and the IP address "ge1 0.0.0.0, 0.0.0.0".
- Policy:** Includes a "Local policy:" field with a dropdown menu set to "NAT\_WAN\_IP" (highlighted with a red border) and the IP address "HOST, 172.100.20.30".

Go to **CONFIGURATION > VPN > L2TP VPN > Create new Object > User** to add **User Name** and **Password** (4-24 characters). Then, set **Allowed User** to the newly created object (L2TP\_Remote\_Users/zyx168 in this example).

**CONFIGURATION > VPN > L2TP VPN > Create new Object > User**

The screenshot shows the 'L2TP VPN' configuration interface. At the top, there is a 'Create new Object' dropdown menu with 'User' selected. Below this, the 'General Settings' section is visible. It includes a checkbox for 'Enable L2TP Over IPSec' which is checked. Other settings include 'VPN Connection' set to 'WIZ\_L2TP\_VPN', 'IP Address Pool' set to 'WIZ\_L2TP\_VPN\_IP\_A', and 'Authentication Method' set to 'default'. The 'Allowed User' dropdown is currently set to 'any'.

The 'Add A User' dialog box is shown. It has a 'User Configuration' section with the following fields: 'User Name' (L2TP\_Remote\_Users), 'User Type' (User), 'Password' (masked with asterisks), and 'Retype' (masked with asterisks). There are also 'Authentication Timeout Settings' for Lease Time and Reauthentication Time, both set to 1440 minutes.

## Set Up the NAT Router (Using ZyWALL USG device in this example)

Go to **CONFIGURATION > Network > NAT > Add**. Select the **Incoming Interface** on which packets for the NAT rule must be received. Specified the **User-Defined Original IP** field and Type the translated destination IP address that this NAT rule supports.

**CONFIGURATION > Network > NAT > Add**

**General Settings**

Enable Rule

Rule Name:

---

**Port Mapping Type**

Classification:  Virtual Server  1:1 NAT  Many 1:1 NAT

---

**Mapping Rule**

Incoming Interface:

Original IP:

    User-Defined Original IP:  (IP Address)

Mapped IP:

    User-Defined Mapped IP:  (IP Address)

Port Mapping Type: any

Go to **CONFIGURATION > Object > Address > Add**, create an address object as the ZyWALL/USU\_HQ's WAN IP address (in the example, 192.168.1.33).

**CONFIGURATION > Object > Address**

**+ Add Address Rule** ? X

Name:

Address Type:

IP Address:

Go to **CONFIGURATION > Object > Service > Service Group**, create a service group for the following UDP ports:

UDP Port Number = 1701 → Used by L2TP

UDP Port Number = 500 → Used by IKE

UDP Port Number = 4500 → Used by NAT-T



## CONFIGURATION > Service > Service Group

**+ Add Service Group Rule**

**Configuration**

Name:

Description:

**Configuration**

**Available**

=== Object ===

- AH
- AIM
- AUTH
- Any\_TCP
- Any\_UDP
- BGP
- BONJOUR
- BOOTP\_CLIENT

**Member**

=== Object ===

- NATT
- IKE
- L2TP-UDP

**OK** **Cancel**

Go to **CONFIGURATION > Security Policy > Policy Control**, add corresponding rule to allow L2TP services.

## CONFIGURATION > Security Policy > Policy Control

**+ Add corresponding**

Create new Object ▼

Enable

Name:

Description:  (Optional)

From:

To:

Source:

Destination:

Service:

User:

Schedule:

Action:

Log matched traffic:

## Test the L2TP over IPSec VPN Tunnel

Use a smartphone or a PC to establish a L2TP VPN connection to the ZyWALL/USG. Configure the NAT's public IP address as the L2TP server address on the client. In this example using iOS device to test the result:

To configure L2TP VPN in an iOS 8.4 device, go to **Menu > Settings > VPN > Add VPN Configuration** and configure as follows.

**Description** is for you to identify the VPN configuration.

Set **Server** to the ZyWALL/USG's WAN IP address (172.100.20.30 in this example).

Enter **Account** and **Password** which the same as **Allowed User** created in ZyWALL/USG (L2TP\_Remote\_Users/zyx168 in this example).

Set **Secret** to the **Pre-Shared Key** of the IPSec VPN gateway the ZyWALL/USG uses for L2TP VPN over IPSec (xyz12345 in this example).

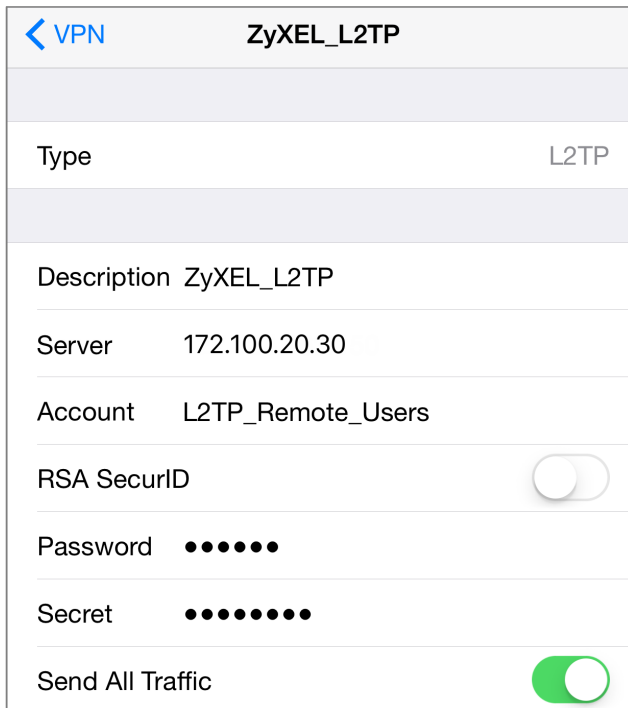

After you create a VPN configuration, slide the button right to the on position to initiate L2TP VPN session.

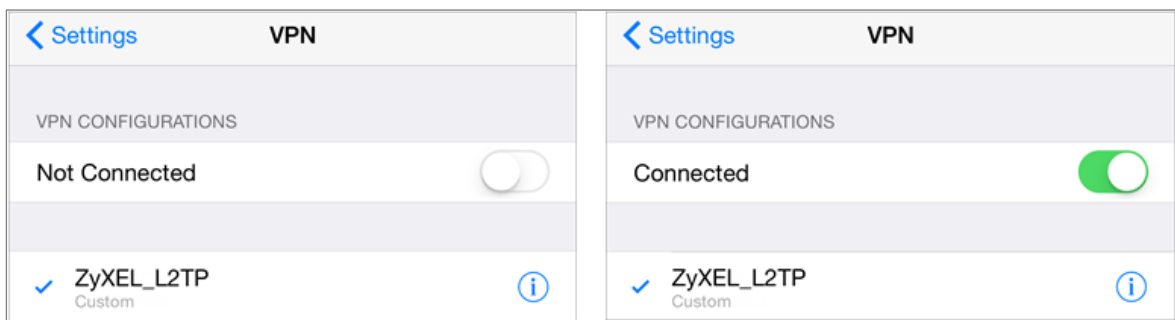

Go to ZyWALL/USG **CONFIGURATION > VPN > IPSec VPN > VPN Connection**, click **Connect** on the upper bar. The **Status** connect icon is lit when the interface is connected.

**CONFIGURATION > VPN > IPSec VPN > VPN Connection**

IPv4 Configuration				
#	Status	Name	VPN Gateway	Policy
1		WIZ_L2TP_VPN	WIZ_L2TP_VPN	<a href="#">WIZ_L2TP_VPN_LOCAL/</a>

Go to ZyWALL/USG **MONITOR > VPN Monitor > L2TP over IPSec** and verify the **Current L2TP Session**.

**MONITOR > VPN Monitor > L2TP over IPSec > L2TP\_Remote\_Users**

Current L2TP Session				
#	User Name	Hostname	Assigned IP	Public IP
1	L2TP_Remote_Users	Android	192.168.10.10	10.214.30.69

Page 1 of 1 | Show 50 items | Displaying 1 - 1 of 1

Go to iOS mobile device **Menu > Settings > VPN > ZyXEL\_L2TP** and verify the **Assigned IP Address** and **Connect Time**.

Menu > Settings > VPN > ZyXEL\_L2TP

VPN		ZyXEL_L2TP
Type	L2TP	
Server	172.100.20.30	
Assigned IP Address	192.168.10.10	
Connect Time	0:06	
Description ZyXEL_L2TP		
Server	172.100.20.30	
Account	L2TP_Remote_Users	
RSA SecurID	<input type="checkbox"/>	
Password	●●●●●●	
Secret	●●●●●●●●	
Send All Traffic	<input checked="" type="checkbox"/>	

## What Could Go Wrong?

If you see [alert] log message such as below, please check ZyWALL/USG L2TP

**Allowed User** or **User/Group Settings**. iOS Mobile users must use the same Username and Password as configured in ZyWALL/USG to establish the L2TP VPN.

Priority	Category	Message	Note
alert	L2TP Over IPSec	User L2TP_Remote_Users has been denied from L2TP service.(Incorrect Username or Password)	L2TP_LOG

If you see [info] or [error] log message such as below, please check ZyWALL/USG Phase 1 Settings. iOS Mobile users must use the same **Secret** as configured in ZyWALL/USG to establish the IKE SA.

Priority	Category	Message	Note
info	IKE	Send:[NOTIFY:INVALID_PAYLOAD_TYPE]	IKE_LOG
info	IKE	Invalid payload type in encrypted payload chain, possibly because of different pre-shared keys	IKE_LOG

If you see that Phase 1 IKE SA process has completed but still get [info] log message as below, please check ZyWALL/USG Phase 2 Settings. ZyWALL/USG unit must set correct **Local Policy** to establish the IKE SA.

Priority	Category	Message	Note
info	IKE	ISAKMP SA [WIZ_L2TP_VPN] is disconnected	IKE_LOG
info	IKE	Received delete notification	IKE_LOG
info	IKE	Recv:[HASH][DEL]	IKE_LOG
info	IKE	Send:[HASH][NOTIFY:NO_PROPOSAL_CHOSEN]	IKE_LOG
info	IKE	[SA] : No proposal chosen	IKE_LOG
info	IKE	[ID] : Tunnel [WIZ_L2TP_VPN] Phase 2 Local policy mismatch	IKE_LOG

Ensure that the L2TP Address Pool does not conflict with any existing LAN1, LAN2, DMZ, or WLAN zones, even if they are not in use.

If you cannot access devices in the local network, verify that the devices in the local network set the USG's IP as their default gateway to utilize the L2TP tunnel.

Make sure the ZyWALL/USG units' security policies allow IPSec VPN traffic. IKE uses UDP port 500, AH uses IP protocol 51, and ESP uses IP protocol 50.

Verify that the **Zone** is set correctly in the **Zone** object. This should be set to IPSec\_VPN Zone so that security policies are applied properly.

## How to Configure L2TP VPN with Android 5.0 Mobile Devices

This example shows how to use the VPN Setup Wizard to create a L2TP VPN between a ZyWALL/USG and an Android 5.0 Mobile Device. The example instructs how to configure the VPN tunnel between each site. When the VPN tunnel is configured, each site can be accessed securely and allow traffic from L2TP clients to go to the Internet.

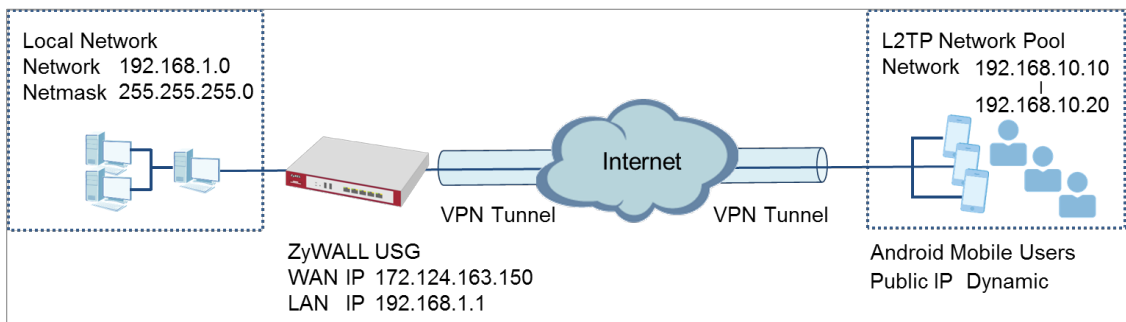

ZyWALL/USG L2TP VPN with Android Mobile Devices Example

 Note: All network IP addresses and subnet masks are used as examples in this article. Please replace them with your actual network IP addresses and subnet masks. This example was tested using USG310 (Firmware Version: 4.25) and Android version (Firmware Version: 5.0)

## Set Up the L2TP VPN Tunnel on the ZyWALL/USG

In the ZyWALL/USG, go to **Quick Setup > VPN Setup Wizard**, use the **VPN Settings for L2TP VPN Settings** wizard to create a **L2TP VPN** rule that can be used with the remote Android Mobile Devices. Click **Next**.

**Quick Setup > VPN Setup Wizard > Welcome**

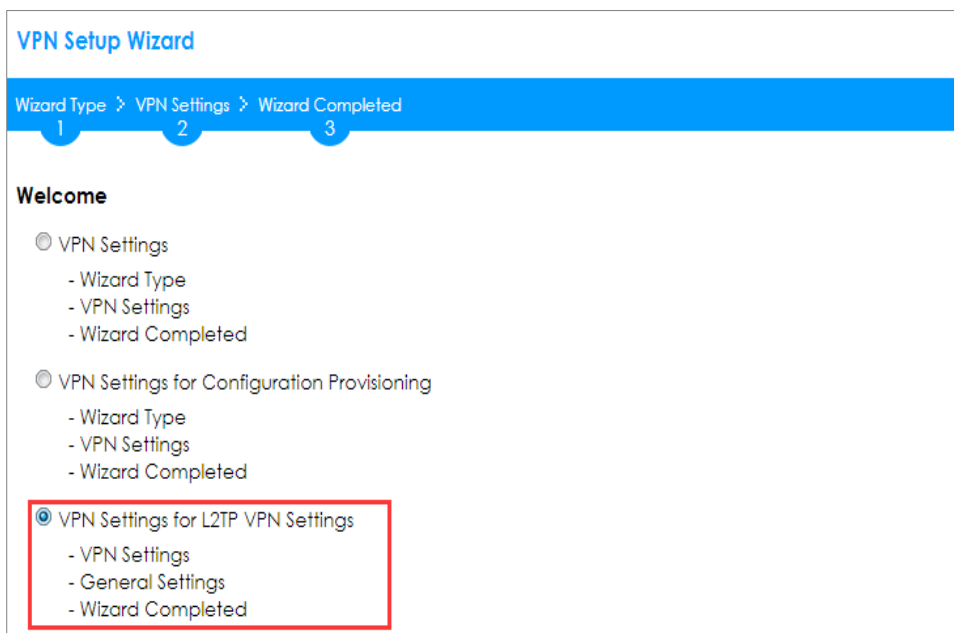

Then, configure the **Rule Name** and set **My Address** to be the **wan1** interface which is connected to the Internet. Type a secure **Pre-Shared Key** (8-32 characters).



Quick Setup > VPN Setup Wizard > Welcome > VPN Settings

VPN Setup Wizard

VPN Settings > General Settings > Wizard Completed

1 2 3

**L2TP VPN Settings**

Rule Name:

**Phase 1 Setting**

My Address (interface):

**Authentication Method**

Pre-Shared Key:

Assign the remote users IP addresses range from 192.168.10.10 to 192.168.10.20 for use in the L2TP VPN tunnel and check **Allow L2TP traffic Through WAN** to allow traffic from L2TP clients to go to the Internet. Click **Next**.

Quick Setup > VPN Setup Wizard > Welcome > VPN Settings (L2TP VPN Settings)

VPN Setup Wizard

VPN Settings > General Settings > Wizard Completed

1 2 3

**L2TP VPN Settings**

IP Address Pool:  ⓘ

Starting IP Address:

End IP Address:

First DNS Server (Optional):

Second DNS Server (Optional):

Allow L2TP traffic Through WAN

This screen provides a read-only summary of the VPN tunnel. Click **Save**.

**Quick Setup > VPN Setup Wizard > Welcome > VPN Settings (Summary)**

**VPN Setup Wizard**

Wizard Type > **VPN Settings** > Wizard Completed  
1
2
3

**Express Settings**

**Summary**

Rule Name:	WIZ_L2TP_VPN
Secure Gateway:	Any
Pre-Shared Key:	xyz12345
My Address (interface):	wan1
IP Address Pool:	RANGE, 192.168.10.10 - 192.168.10.20

Now the rule is configured on the ZyWALL/USG. The rule settings appear in the **VPN > L2TP VPN** screen. Click **Close** to exit the wizard.

**Quick Setup > VPN Setup Wizard > Welcome > VPN Settings > Wizard Completed**

**VPN Setup Wizard**

Wizard Type > VPN Settings > **Wizard Completed**  
1
2
3

**L2TP VPN Settings**

Congratulations. The VPN Access wizard is completed

**Summary**

Rule Name:	WIZ_L2TP_VPN
My Address (interface):	wan1
Pre-Shared Key:	xyz12345
IP Address Pool:	RANGE, 192.168.10.10 - 192.168.10.20

Go to **CONFIGURATION > VPN > L2TP VPN > Create new Object > User** to add **User Name** and **Password** (4-24 characters). Then, set **Allowed User** to the newly created object (L2TP\_Remote\_Users/zyx168 in this example).

**CONFIGURATION > VPN > L2TP VPN > Create new Object > User**

The screenshot shows the 'L2TP VPN' configuration page. At the top, there is a blue header with 'L2TP VPN' and a 'Create new Object' dropdown menu. Below this, there are tabs for 'General Settings', 'Config Walkthrough', 'Address', and 'Reshooting'. The 'General Settings' tab is active. It contains the following fields:

- Enable L2TP Over IPsec
- VPN Connection: WIZ\_L2TP\_VPN
- IP Address Pool: WIZ\_L2TP\_VPN\_IP\_1 RANGE, 192.168.100.10-192.168.100.20
- Authentication Method: default local
- Advance
- Allowed User: any
- Keep Alive Timer: 60 (1-180 seconds)
- First DNS Server (Optional): Custom Defined
- Second DNS Server (Optional): Custom Defined
- First WINS Server (Optional):
- Second WINS Server (Optional):

The 'User Configuration' dialog box is shown with the following fields:

- User Name: L2TP\_Remote\_Users
- User Type: user
- Password: \*\*\*\*\*
- Retype: \*\*\*\*\*
- Description: Local User
- Authentication Timeout Settings:
  - Use Default Settings
  - Use Manual Settings
- Lease Time: 1440 minutes
- Reauthentication Time: 1440 minutes

At the bottom right, there are 'OK' and 'Cancel' buttons.

If some of the traffic from the L2TP clients need to go to the Internet, create a policy route to send traffic from the L2TP tunnels out through a WAN trunk. Set **Incoming** to **Tunnel** and select your L2TP VPN connection. Set the **Source Address** to be the L2TP address pool. Set the **Next-Hop Type** to **Trunk** and select the appropriate WAN trunk.

**CONFIGURATION > Network > Routing > Policy Route**

**Edit Policy Route**

Show Advanced Settings Create new Object

**Configuration**

Enable

Description: L2TP\_VPN\_to\_Internet (Optional)

**Criteria**

User: L2TP\_Remote\_User

Incoming: Tunnel

Please select one member: WIZ\_L2TP\_VPN

Source Address: WIZ\_L2TP\_VPN\_IP\_

Destination Address: any

DSCP Code: any

Schedule: none

Service: any

**Next-Hop**

Type: Trunk

Trunk: SYSTEM\_DEFAULT\_V

OK Cancel

## Set Up the L2TP VPN Tunnel on the Android Device

To configure L2TP VPN on an Android device, go to **Menu > Settings > Wireless & Networks > VPN settings > Add VPN > Add L2TP/IPSec PSK VPN** and configure as follows.

**VPN name** is for the user to identify the VPN configuration.

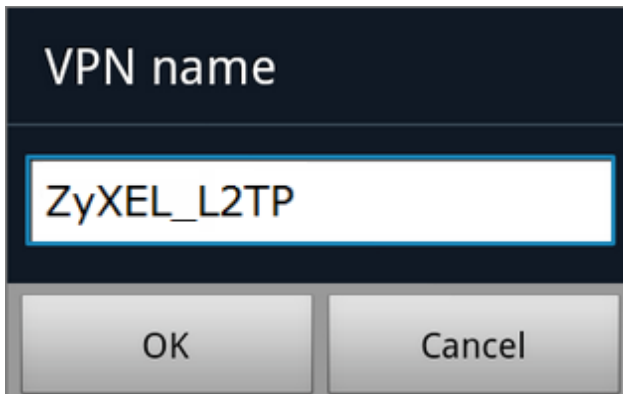

VPN name

OK Cancel

Set **VPN server** to the ZyWALL/USG's WAN IP address.

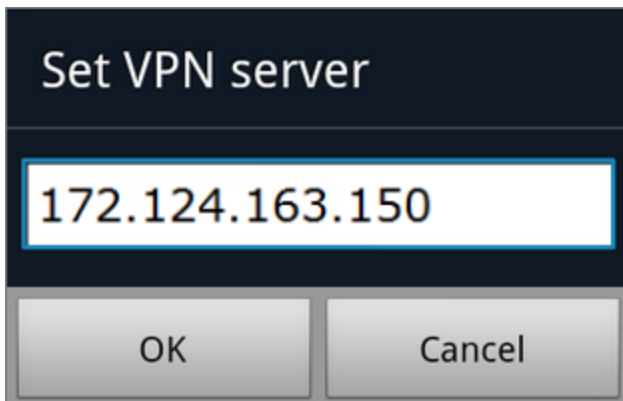

Set VPN server

OK Cancel

Set **IPSec pre-shared key** to the pre-shared key of the IPSec VPN gateway the ZyWALL/USG uses for L2TP VPN over IPSec (zyx12345 in this example).

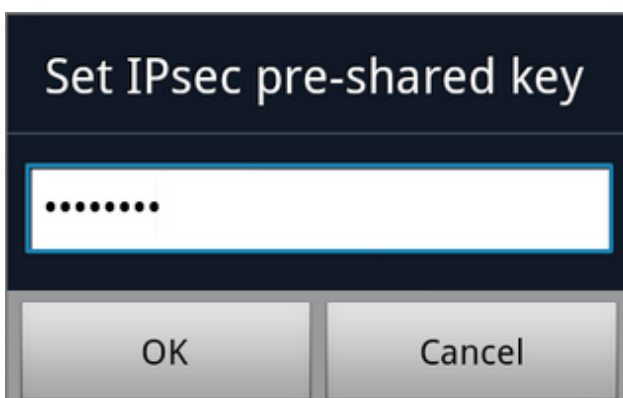

Set IPsec pre-shared key

OK Cancel

Leave **Enable L2TP secret disabled** as default and turn on **DNS search domains** if you need to use the internal DNS servers once your connection is made, enter the DNS server address here. Click **Save**.

**Add L2TP/IPSec PSK VPN**

VPN name  
ZyXEL\_L2TP

Set VPN server  
172.124.163.150

Set IPsec pre-shared key  
IPsec pre-shared key is set

**Enable L2TP secret**  
L2TP secret disabled

Set L2TP secret  
L2TP secret not set

**DNS search domains**  
DNS search domains not set

Save Cancel

Click the VPN rule **ZyXEL\_L2TP** to begin the VPN connection.

**VPN settings**

Add VPN

**VPNs**

**ZyXEL\_L2TP**  
Connect to network

When dialing the L2TP VPN, the user will have to enter Username/Password. They are the same as **Allowed User** created in ZyWALL/USG (L2TP\_Remote\_Users/zyx168 in this example).

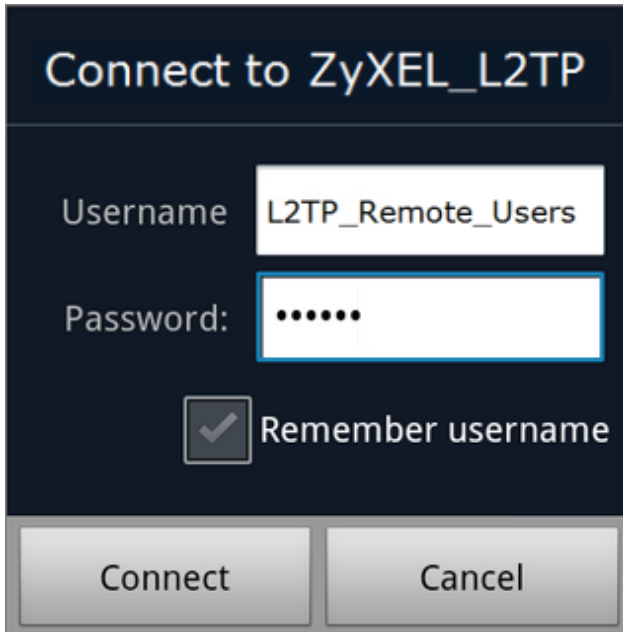

## Test the L2TP over IPSec VPN Tunnel

Go to ZyWALL/USG **CONFIGURATION > VPN > IPSec VPN > VPN Connection**, the **Status** connect icon is lit when the interface is connected.

### CONFIGURATION > VPN > IPSec VPN > VPN Connection

#	Status	Name	VPN Gateway	Policy
1		WIZ_L2TP_VPN	WIZ_L2TP_VPN	<a href="#">WIZ_L2TP_VPN_LOCAL/</a>

Go to ZyWALL/USG **MONITOR > VPN Monitor > IPSec** and verify the tunnel **Up Time** and the **Inbound(Bytes)/Outbound(Bytes)** traffic. Click **Connectivity Check** to verify the result of ICMP Connectivity.

**Hub\_HQ > MONITOR > VPN Monitor > WIZ\_L2TP\_VPN**

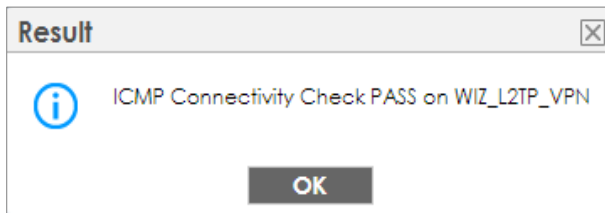
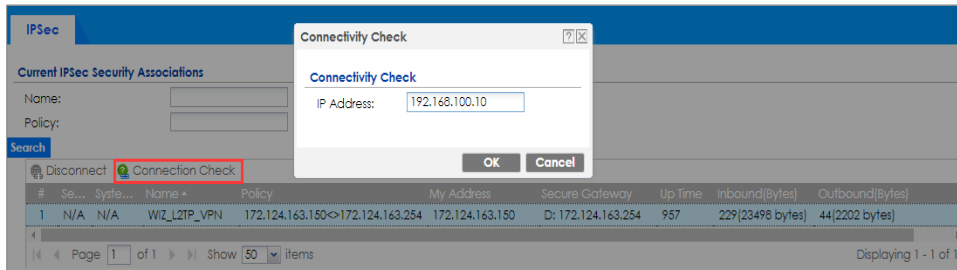

Go to ZyWALL/USG **MONITOR > VPN Monitor > L2TP over IPSec** and verify the **Current L2TP Session**.

**MONITOR > VPN Monitor > L2TP over IPSec > L2TP\_Remote\_Users**

Current L2TP Session				
#	User Name	Hostname	Assigned IP	Public IP
1	L2TP_Remote_Users	Android	192.168.10.10	172.124.163.254



Go to Android mobile device **Menu > Settings > Wireless & Networks > VPN** and verify the connection status.

**Menu > Settings > Wireless & Networks > VPN**

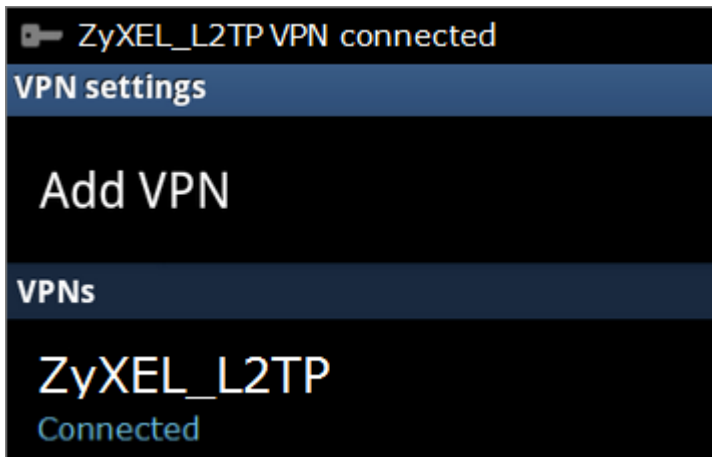

## What Could Go Wrong?

If you see [alert] log message such as below, please check ZyWALL/USG L2TP **Allowed User** or **User/Group Settings**. Android Mobile users must use the same Username and Password as configured in ZyWALL/USG to establish the L2TP VPN.

Priority	Category	Message	Note
alert	L2TP Over IPSec	User L2TP_Remote_Users has been denied from L2TP service.(Incorrect Username or Password)	L2TP_LOG

If you see [info] or [error] log message such as below, please check ZyWALL/USG Phase 1 Settings. Android Mobile users must use the same **Secret** as configured in ZyWALL/USG to establish the IKE SA.

Priority	Category	Message	Note
info	IKE	Send:[NOTIFY:INVALID_PAYLOAD_TYPE]	IKE_LOG
info	IKE	Invalid payload type in encrypted payload chain, possibly because of different pre-shared keys	IKE_LOG

If you see that Phase 1 IKE SA process has completed but still get [info] log message as below, please check ZyWALL/USG Phase 2 Settings. ZyWALL/USG unit must set correct **Local Policy** to establish the IKE SA.

Priority	Category	Message	Note
info	IKE	ISAKMP SA [WIZ_L2TP_VPN] is disconnected	IKE_LOG
info	IKE	Received delete notification	IKE_LOG
info	IKE	Recv:[HASH][DEL]	IKE_LOG
info	IKE	Send:[HASH][NOTIFY:NO_PROPOSAL_CHOSEN]	IKE_LOG
info	IKE	[SA] : No proposal chosen	IKE_LOG
info	IKE	[ID] : Tunnel [WIZ_L2TP_VPN] Phase 2 Local policy mismatch	IKE_LOG

Ensure that the L2TP Address Pool does not conflict with any existing LAN1, LAN2, DMZ, or WLAN zones, even if they are not in use.

If you cannot access devices in the local network, verify that the devices in the local network set the USG's IP as their default gateway to utilize the L2TP tunnel.

Make sure the ZyWALL/USG units' security policies allow IPSec VPN traffic. IKE uses UDP port 500, AH uses IP protocol 51, and ESP uses IP protocol 50.

Verify that the **Zone** is set correctly in the **Zone** object. This should be set to IPSec\_VPN Zone so that security policies are applied properly.

## How to Configure L2TP VPN with iOS 8.4 Mobile Devices

This example shows how to use the VPN Setup Wizard to create a L2TP VPN between a ZyWALL/USG and an iOS 8.4 Mobile Device. The example instructs how to configure the VPN tunnel between each site. When the VPN tunnel is configured, each site can be accessed securely and allow traffic from L2TP clients to go to the Internet.

### ZyWALL/USG L2TP VPN with iOS Mobile Devices Example

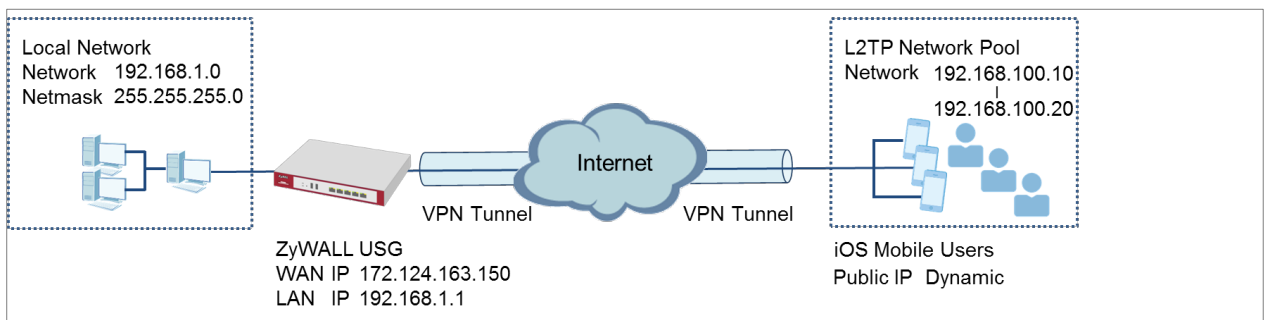

 Note: All network IP addresses and subnet masks are used as examples in this article. Please replace them with your actual network IP addresses and subnet masks. This example was tested using USG310 (Firmware Version: 4.25) and iOS (Firmware Version: 8.4).

## Set Up the L2TP VPN Tunnel on the ZyWALL/USG

In the ZyWALL/USG, go to **Quick Setup > VPN Setup Wizard**, use the **VPN Settings for L2TP VPN Settings** wizard to create a **L2TP VPN** rule that can be used with the remote iOS Mobile Devices. Click **Next**.

**Quick Setup > VPN Setup Wizard > Welcome**

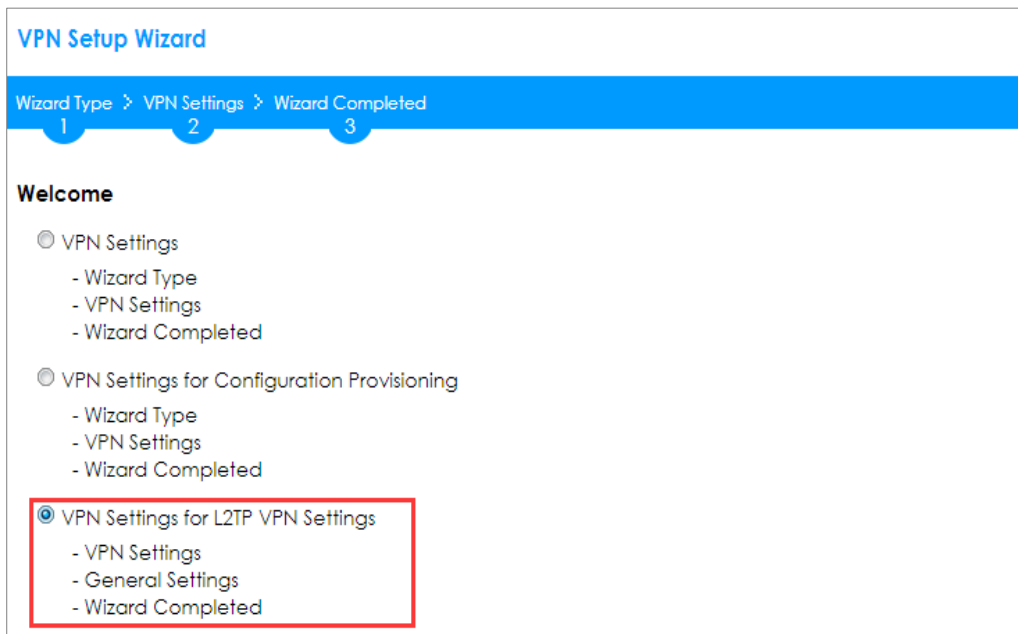

Then, configure the **Rule Name** and set **My Address** to be the **wan1** interface which is connected to the Internet. Type a secure **Pre-Shared Key** (8-32 characters).

**Quick Setup > VPN Setup Wizard > Welcome > VPN Settings**

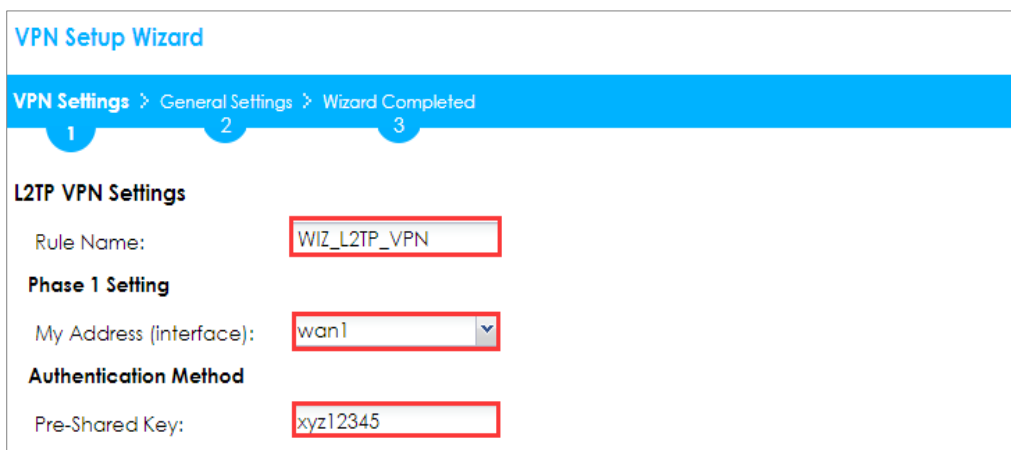

Assign the remote users IP addresses range from 192.168.100.10 to 192.168.100.20 for use in the L2TP VPN tunnel and check **Allow L2TP traffic Through WAN** to allow traffic from L2TP clients to go to the Internet. Click **Next**.

**Quick Setup > VPN Setup Wizard > Welcome > VPN Settings (L2TP VPN Settings)**

**VPN Setup Wizard**

VPN Settings > General Settings > Wizard Completed

1 2 3

**L2TP VPN Settings**

IP Address Pool: RANGE ⓘ

Starting IP Address: 192.168.100.10

End IP Address: 192.168.100.20

First DNS Server (Optional):

Second DNS Server (Optional):

Allow L2TP traffic Through WAN

This screen provides a read-only summary of the VPN tunnel. Click **Save**.

**Quick Setup > VPN Setup Wizard > Welcome > VPN Settings (Summary)**

**VPN Setup Wizard**

Wizard Type > VPN Settings > Wizard Completed

1 2 3

**Express Settings**

**Summary**

Rule Name: WIZ\_L2TP\_VPN

Secure Gateway: Any

Pre-Shared Key: xyz12345

My Address (interface): wan1

IP Address Pool: RANGE, 192.168.10.10 - 192.168.10.20

Now the rule is configured on the ZyWALL/USG. The rule settings appear in the **VPN > L2TP VPN** screen. Click **Close** to exit the wizard.

**Quick Setup > VPN Setup Wizard > Welcome > VPN Settings > Summary > Wizard Completed**

### VPN Setup Wizard

Wizard Type > VPN Settings > **Wizard Completed**

1 2 3

#### L2TP VPN Settings

Congratulations. The VPN Access wizard is completed

Summary

Rule Name:	WIZ_L2TP_VPN
My Address (interface):	wan1
Pre-Shared Key:	xyz12345
IP Address Pool:	RANGE, 192.168.100.10 - 192.168.100.20

Go to **CONFIGURATION > VPN > L2TP VPN > Create new Object > User** to add **User Name** and **Password** (4-24 characters). Then, set **Allowed User** to the newly created object (L2TP\_Remote\_Users/zyx168 in this example).

CONFIGURATION > VPN > L2TP VPN > Create new Object > User

**L2TP VPN**

Show Advanced Settings Create new Object

User

General Settings

Enable L2TP Over IPsec

VPN Connection: WIZ\_L2TP\_VPN

IP Address Pool: WIZ\_L2TP\_VPN\_IP\_1 RANGE, 192.168.100.10-192.168.100.20

Authentication Method: default local

Advance

Allowed User: any

Keep Alive Timer: 60 (1-180 seconds)

First DNS Server (Optional): Custom Defined

Second DNS Server (Optional): Custom Defined

First WINS Server (Optional):

Second WINS Server (Optional):

**User Configuration**

User Name : L2TP\_Remote\_Users

User Type : User

Password : \*\*\*\*\*

Retype : \*\*\*\*\*

Description : Local User

Authentication Timeout Settings

Use Default Settings  Use Manual Settings

Lease Time: 1440 minutes

Reauthentication Time: 1440 minutes

OK Cancel

If some of the traffic from the L2TP clients need to go to the Internet, create a policy route to send traffic from the L2TP tunnels out through a WAN trunk. Set **Incoming** to **Tunnel** and select your L2TP VPN connection. Set the **Source Address** to be the L2TP address pool. Set the **Next-Hop Type** to **Trunk** and select the appropriate WAN trunk.

## CONFIGURATION > Network > Routing > Policy Route

**Edit Policy Route** [?] [X]

Show Advanced Settings Create new Object ▾

---

**Configuration**

Enable

Description:  (Optional)

---

**Criteria**

User:  ▾

Incoming:  ▾

Please select one member:  ▾

Source Address:  ▾

Destination Address:  ▾

DSCP Code:  ▾

Schedule:  ▾

Service:  ▾

---

**Next-Hop**

Type:  ▾

Trunk:  ▾

OK Cancel



## Set Up the L2TP VPN Tunnel on the iOS Device

To configure L2TP VPN in an iOS 8.4 device, go to **Menu > Settings > VPN > Add VPN Configuration** and configure as follows.

**Description** is for you to identify the VPN configuration.

Set **Server** to the ZyWALL/USG's WAN IP address (172.124.163.150 in this example).

Enter **Account** and **Password** which the same as **Allowed User** created in ZyWALL/USG (L2TP\_Remote\_Users/zyx168 in this example).

Set **Secret** to the **Pre-Shared Key** of the IPSec VPN gateway the ZyWALL/USG uses for L2TP VPN over IPSec (zyx12345 in this example).

ZyXEL_L2TP	
Type	L2TP
Description	ZyXEL_L2TP
Server	172.124.163.150
Account	L2TP_Remote_Users
RSA SecurID	<input type="checkbox"/>
Password	●●●●●●
Secret	●●●●●●●●
Send All Traffic	<input checked="" type="checkbox"/>

After you create a VPN configuration, slide the button right to the on position to initiate L2TP VPN session.

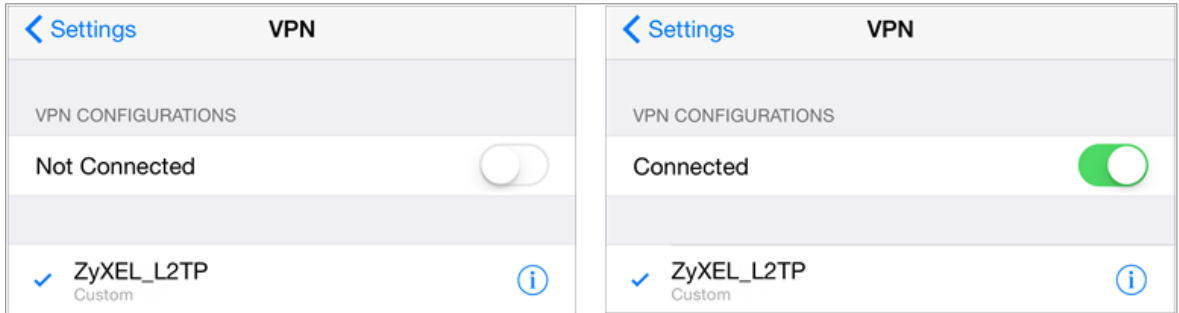

## Test the L2TP over IPSec VPN Tunnel

Go to ZyWALL/USG **CONFIGURATION > VPN > IPSec VPN > VPN Connection**, the **Status** connect icon is lit when the interface is connected.

### CONFIGURATION > VPN > IPSec VPN > VPN Connection

#	Status	Name	VPN Gateway	Policy
1		WIZ_L2TP_VPN	WIZ_L2TP_VPN	<a href="#">WIZ_L2TP_VPN_LOCAL/</a>

Go to ZyWALL/USG **MONITOR > VPN Monitor > IPSec** and verify the tunnel **Up Time** and the **Inbound(Bytes)/Outbound(Bytes)** traffic. Click **Connectivity Check** to verify the result of ICMP Connectivity.

**Hub\_HQ > MONITOR > VPN Monitor > IPSec > WIZ\_L2TP\_VPN**

The screenshot shows the 'Current IPSec Security Associations' table with the following data:

#	S...	S...	Name	Policy	My Address	Secure Gate...	Up Time	Timeout	Inbound(Byte)	Outbound(B...
1	N/A	N/A	WIZ_L2TP_VPN	10.214.30.64<>10.214.30.69	10.214.30.64	D: 10.214.30.69	56	3564	201(33810 byt...	23(1363 bytes)

The 'Result' dialog box displays the following message:

**Result**  
 ICMP Connectivity Check PASS on WIZ\_L2TP\_VPN

Go to ZyWALL/USG **MONITOR > VPN Monitor > L2TP over IPSec** and verify the **Current L2TP Session**.

**MONITOR > VPN Monitor > L2TP over IPSec > L2TP\_Remote\_Users**

The 'Current L2TP Session' table contains the following data:

#	User Name	Hostname	Assigned IP	Public IP
1	L2TP_Remote_Users	iPhone	192.168.100.10	10.214.30.69

Go to iOS mobile device **Menu > Settings > VPN > ZyXEL\_L2TP** and verify the **Assigned IP Address** and **Connect Time**.

**Menu > Settings > VPN > ZyXEL\_L2TP**

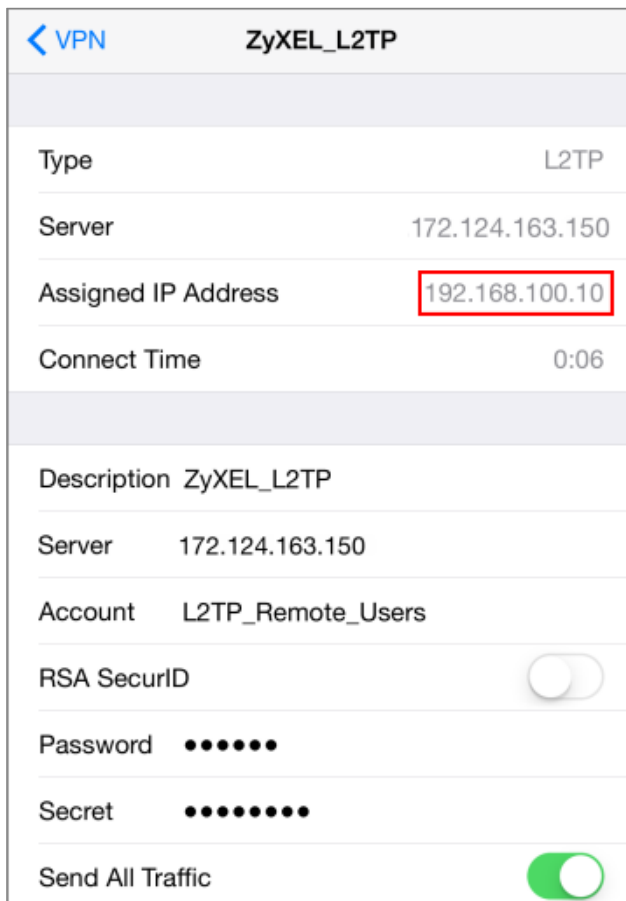

## What Could Go Wrong?

If you see [alert] log message such as below, please check ZyWALL/USG L2TP **Allowed User** or **User/Group Settings**. iOS Mobile users must use the same Username and Password as configured in ZyWALL/USG to establish the L2TP VPN.

Priority	Category	Message	Note
alert	L2TP Over IPSec	User L2TP_Remote_Users has been denied from L2TP service.(Incorrect Username or Password)	L2TP_LOG

If you see [info] or [error] log message such as below, please check ZyWALL/USG Phase 1 Settings. iOS Mobile users must use the same **Secret** as configured in ZyWALL/USG to establish the IKE SA.

Priority	Category	Message	Note
info	IKE	Send:[NOTIFY:INVALID_PAYLOAD_TYPE]	IKE_LOG
info	IKE	Invalid payload type in encrypted payload chain, possibly because of different pre-shared keys	IKE_LOG

If you see that Phase 1 IKE SA process has completed but still get [info] log message as below, please check ZyWALL/USG Phase 2 Settings. ZyWALL/USG unit must set correct **Local Policy** to establish the IKE SA.

Priority	Category	Message	Note
info	IKE	ISAKMP SA [WIZ_L2TP_VPN] is disconnected	IKE_LOG
info	IKE	Received delete notification	IKE_LOG
info	IKE	Recv:[HASH][DEL]	IKE_LOG
info	IKE	Send:[HASH][NOTIFY:NO_PROPOSAL_CHOSEN]	IKE_LOG
info	IKE	[SA] : No proposal chosen	IKE_LOG
info	IKE	[ID] : Tunnel [WIZ_L2TP_VPN] Phase 2 Local policy mismatch	IKE_LOG

Ensure that the L2TP Address Pool does not conflict with any existing LAN1, LAN2, DMZ, or WLAN zones, even if they are not in use.

If you cannot access devices in the local network, verify that the devices in the local network set the USG's IP as their default gateway to utilize the L2TP tunnel.

Make sure the ZyWALL/USG units' security policies allow IPSec VPN traffic. IKE uses UDP port 500, AH uses IP protocol 51, and ESP uses IP protocol 50.

Verify that the **Zone** is set correctly in the **Zone** object. This should be set to IPSec\_VPN Zone so that security policies are applied properly.

## How to Import ZyWALL/USG Certificate for L2TP over IPsec in Windows 10

This is an example of using the L2TP VPN and VPN client software included in Windows 10 operating systems. When the VPN tunnel is configured, users can securely access the network behind the ZyWALL/USG and allow traffic from L2TP clients to go to the Internet from a Windows 10 computer.

ZyWALL/USG L2TP VPN with Remote Windows 10 Client Example

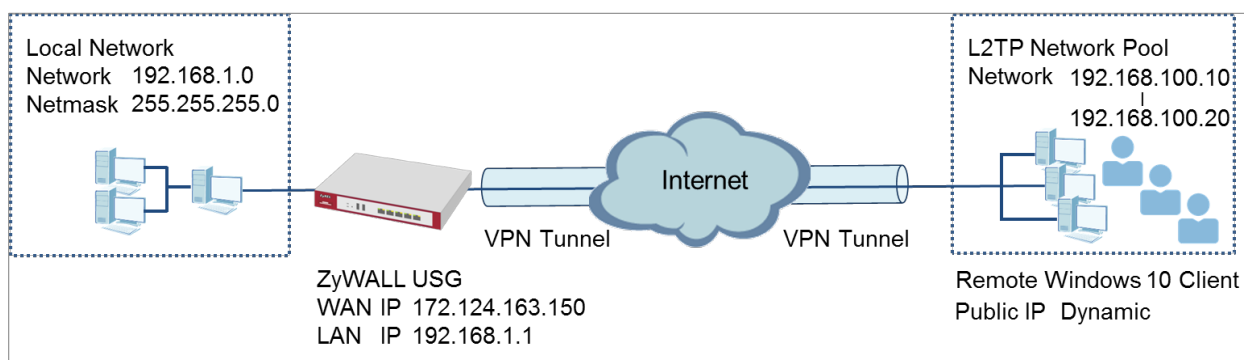

 Note: All network IP addresses and subnet masks are used as examples in this article. Please replace them with your actual network IP addresses and subnet masks. This example was tested using USG310 (Firmware Version: 4.25) and Windows 10 Pro (Version: 10.0.10240)

### Set Up the L2TP VPN Tunnel on the ZyWALL/USG

In the ZyWALL/USG, go to **Quick Setup > VPN Setup Wizard**, use the **VPN Settings for L2TP VPN Settings** wizard to create a **L2TP VPN** rule that can be used with the Window 10 clients. Click **Next**.

**Quick Setup > VPN Setup Wizard > Welcome**

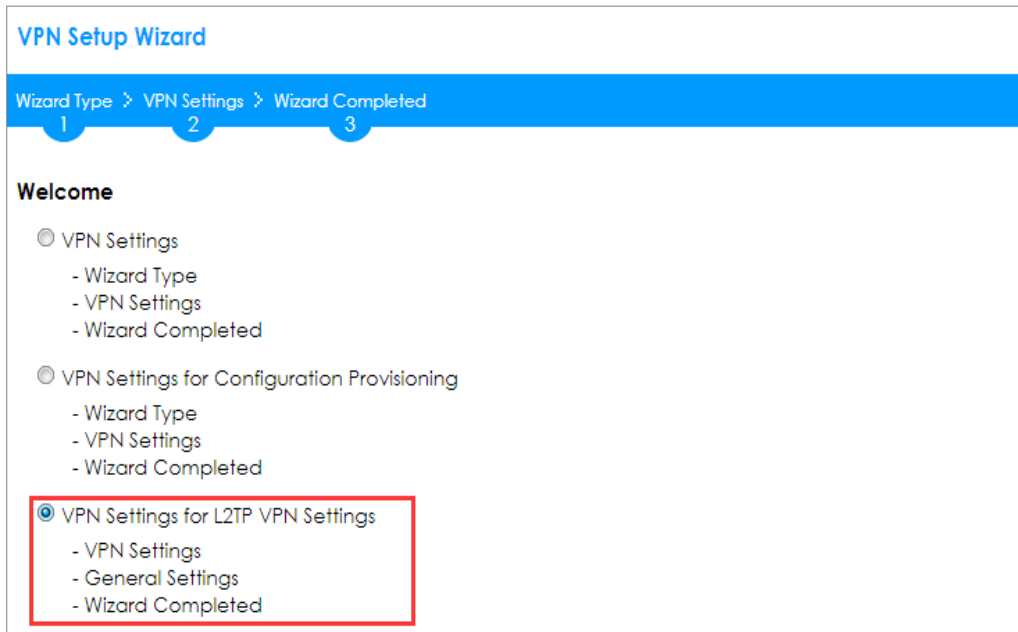

Then, configure the **Rule Name** and set **My Address** to be the **wan1** interface which is connected to the Internet. Type a secure **Pre-Shared Key** (8-32 characters).

**Quick Setup > VPN Setup Wizard > Welcome > VPN Settings**

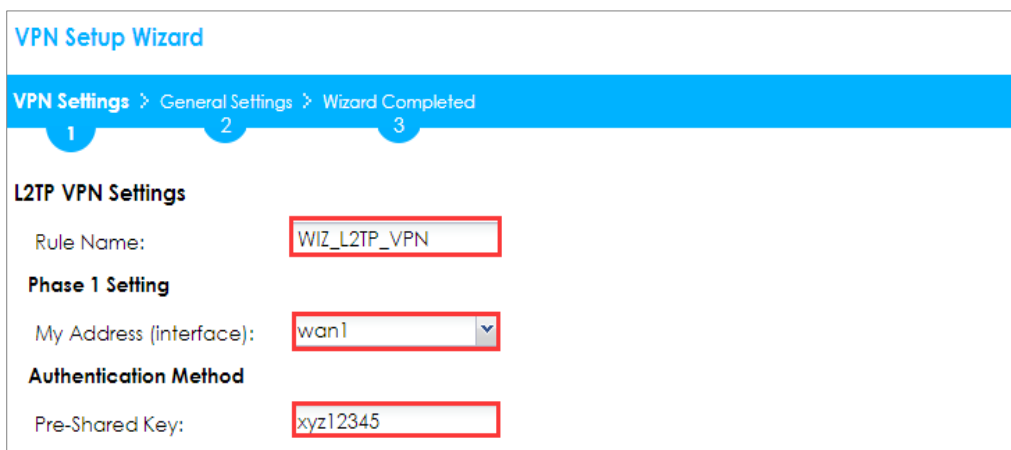

Assign the L2TP users' IP address range from 192.168.100.10 to 192.168.100.20 for use in the L2TP VPN tunnel and select **Allow L2TP traffic Through WAN** to allow traffic from L2TP clients to go to the Internet. Click **OK**.



## Quick Setup > VPN Setup Wizard > Welcome > VPN Settings (L2TP VPN Settings)

### VPN Setup Wizard

VPN Settings > General Settings > Wizard Completed

1 2 3

#### L2TP VPN Settings

IP Address Pool: RANGE ⓘ

Starting IP Address: 192.168.100.10

End IP Address: 192.168.100.20

First DNS Server (Optional):

Second DNS Server (Optional):

Allow L2TP traffic Through WAN

This screen provides a read-only summary of the VPN tunnel. Click **Save**.

## Quick Setup > VPN Setup Wizard > Welcome > VPN Settings (Summary)

### VPN Setup Wizard

Wizard Type > VPN Settings > Wizard Completed

1 2 3

#### Express Settings

##### Summary

Rule Name:	WIZ_L2TP_VPN
Secure Gateway:	Any
Pre-Shared Key:	xyz12345
My Address (interface):	wan1
IP Address Pool:	RANGE, 192.168.10.10 - 192.168.10.20

Now the rule is configured on the ZyWALL/USG. The rule settings appear in the **VPN > L2TP VPN** screen. Click **Close** to exit the wizard.

**Quick Setup > VPN Setup Wizard > Welcome > VPN Settings > Wizard Completed**

**VPN Setup Wizard**

Wizard Type > **VPN Settings** > Wizard Completed

1 2 3

**Express Settings**

**Summary**

Rule Name:	WIZ_L2TP_VPN
Secure Gateway:	Any
Pre-Shared Key:	xyz12345
My Address (interface):	wan1
IP Address Pool:	RANGE, 192.168.10.10 - 192.168.10.20

Go to **CONFIGURATION > VPN > VPN Gateway > WIZ\_L2TP\_VPN**, change **Authentication** method to be **Certificate** and select the certificate which ZyWALL/USG uses to identify itself to the Window 10 computer.

**CONFIGURATION > VPN > VPN Gateway > WIZ\_L2TP\_VPN > Authentication > Certificate**

**Authentication**

Pre-Shared Key

unmasked

Certificate default (See [My Certificates](#))

User Based PSK  ⓘ

Go to **CONFIGURATION > VPN > L2TP VPN > Create new Object > User** to add **User Name** and **Password** (4-24 characters). Then, set **Allowed User** to the newly created object (L2TP\_Remote\_Users/zyx168 in this example).

**CONFIGURATION > VPN > L2TP VPN > Create new Object > User**

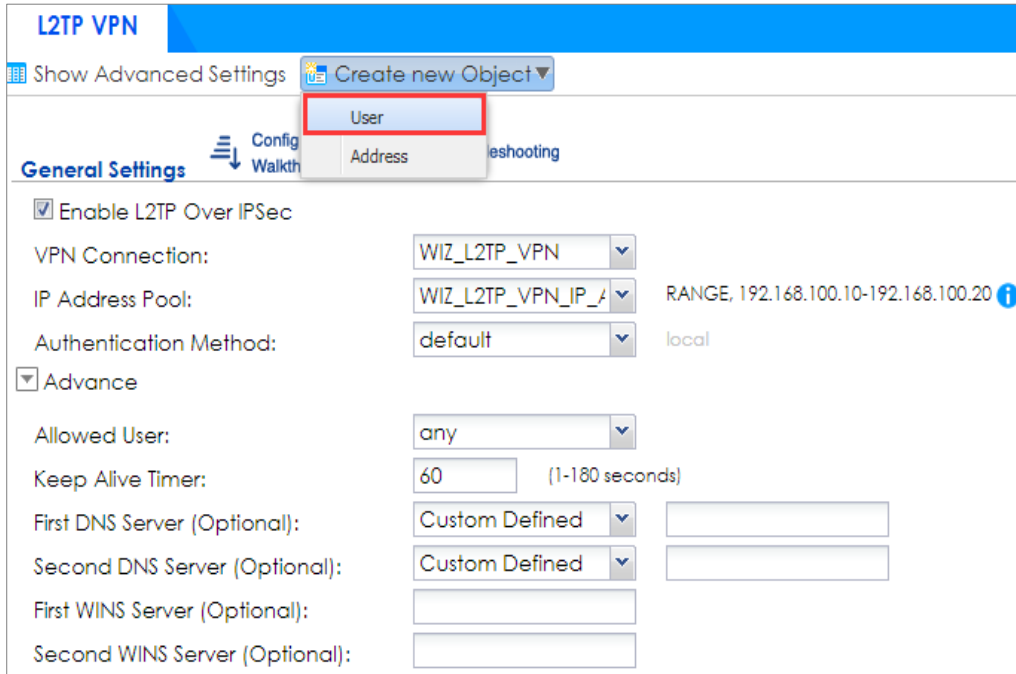

**L2TP VPN**

Show Advanced Settings Create new Object

User

**General Settings**

- Enable L2TP Over IPsec
- VPN Connection: WIZ\_L2TP\_VPN
- IP Address Pool: WIZ\_L2TP\_VPN\_IP\_1 RANGE, 192.168.100.10-192.168.100.20
- Authentication Method: default local
- Advance
  - Allowed User: any
  - Keep Alive Timer: 60 (1-180 seconds)
  - First DNS Server (Optional): Custom Defined
  - Second DNS Server (Optional): Custom Defined
  - First WINS Server (Optional):
  - Second WINS Server (Optional):

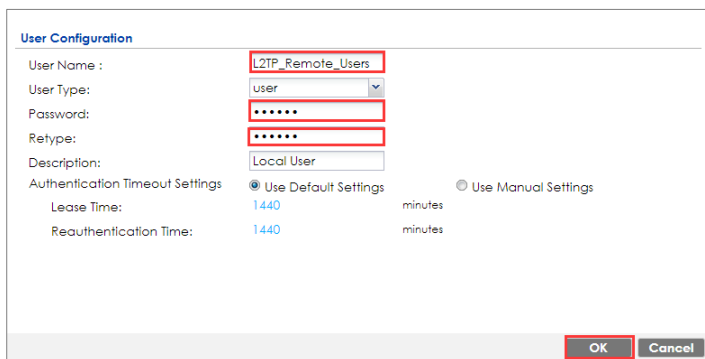

**User Configuration**

- User Name : L2TP\_Remote\_Users
- User Type: User
- Password: .....
- Retype: .....
- Description: Local User
- Authentication Timeout Settings:
  - Use Default Settings
  - Use Manual Settings
- Lease Time: 1440 minutes
- Reauthentication Time: 1440 minutes

OK Cancel

If some of the traffic from the L2TP clients need to go to the Internet, create a policy route to send traffic from the L2TP tunnels out through a WAN trunk. Set **Incoming** to **Tunnel** and select your L2TP VPN connection. Set the **Source Address** to be the L2TP address pool. Set the **Next-Hop Type** to **Trunk** and select the appropriate WAN trunk.

**CONFIGURATION > Network > Routing > Policy Route**

**Edit Policy Route**

Show Advanced Settings Create new Object ▼

**Configuration**

Enable

Description: L2TP\_VPN\_to\_Internet (Optional)

**Criteria**

User: L2TP\_Remote\_User ▼

Incoming: Tunnel ▼

Please select one member: WIZ\_L2TP\_VPN ▼

Source Address: WIZ\_L2TP\_VPN\_IP\_... ▼

Destination Address: any ▼

DSCP Code: any ▼

Schedule: none ▼

Service: any ▼

**Next-Hop**

Type: Trunk ▼

Trunk: SYSTEM\_DEFAULT\_V... ▼

OK Cancel

## Export a Certificate from ZyWALL/USG and Import it to Windows 10 Operating System

Go to ZyWALL/USG **CONFIGURATION > Object > Certificate**, select the certificate (**default** in this example) and click **Edit**.

**CONFIGURATION > Object > Certificate > default**

My Certificates Setting

+ Add Edit Remove Object References

#	Name ▲	Type	Subject	Issuer	Valid From	Valid To
1	default	SELF	CN=vpn50_88ECA31E2398	CN=vpn50_88ECA31E2398	2017-01-07 10:19:45 GMT	2027-01-05 10:19:45 GMT

Export default certificate from ZyWALL/USG with Private Key (zyx123 in this example)

## CONFIGURATION > Object > Certificate > default > Edit > Export Certificate with Private Key

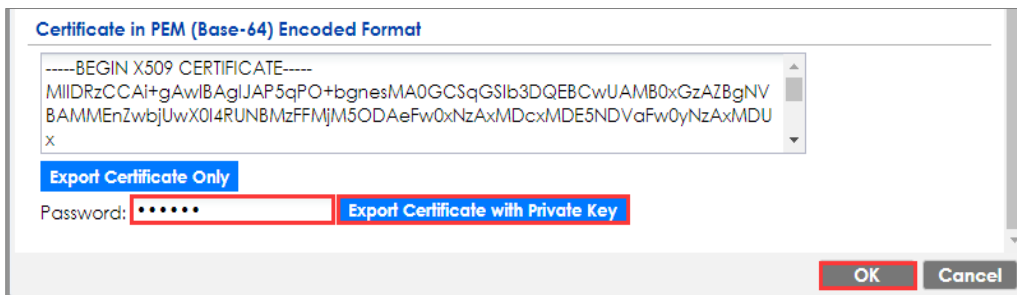

Save **default** certificate as **\*.p12** file to Windows 10 computer.



default.p12

In Windows 10 Operating System, go to **Start Menu > Search Box**. Type **mmc** and press **Enter**.

### Start Menu > Search Box > mmc

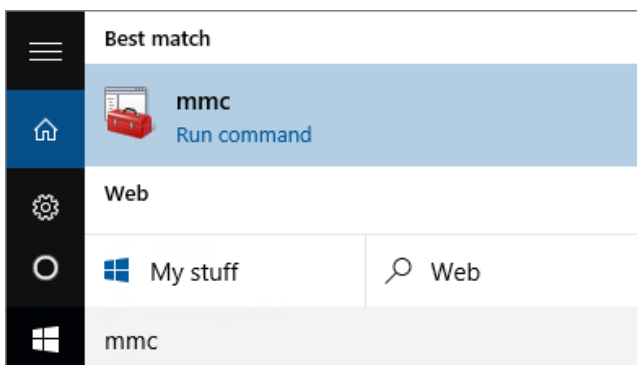

In the mmc console window, click **File > Add/Remove Snap-in...**

## File > Add/Remove Snap-in...

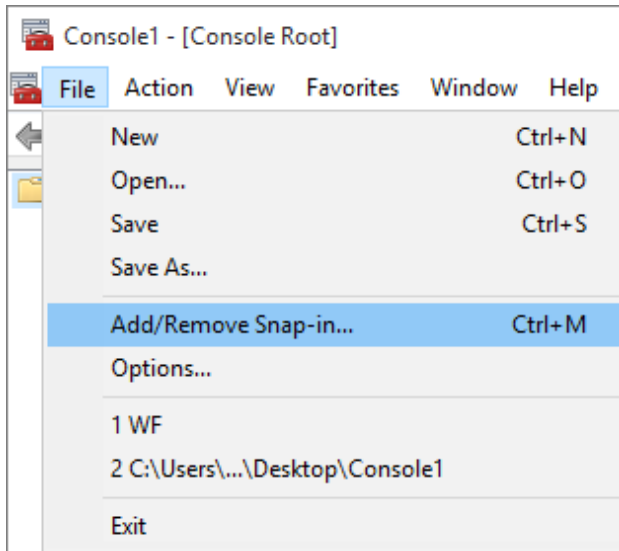

In the **Available snap-ins**, select **Certificates** click **Add**. Then, click **Finished**.

Press **OK** to close the Snap-ins window.

## Available snap-ins > Certificates > Add

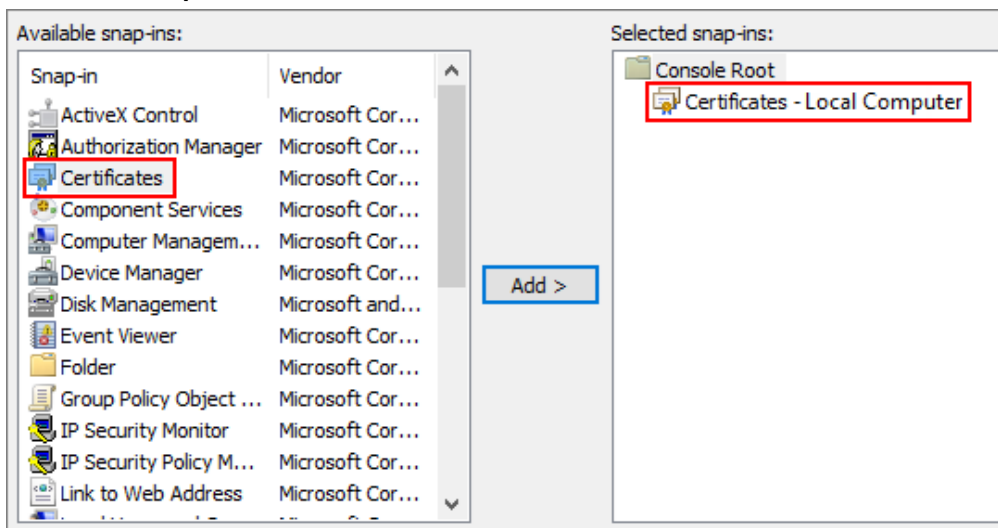

In the mmc console window, go to **Certificates (Local Computer) > Trusted Root Certification Authorities**, right click **Certificate > All Tasks > Import...**

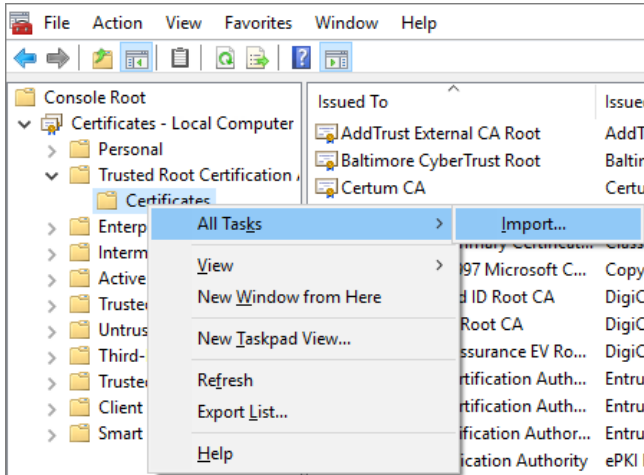

Click **Next**.

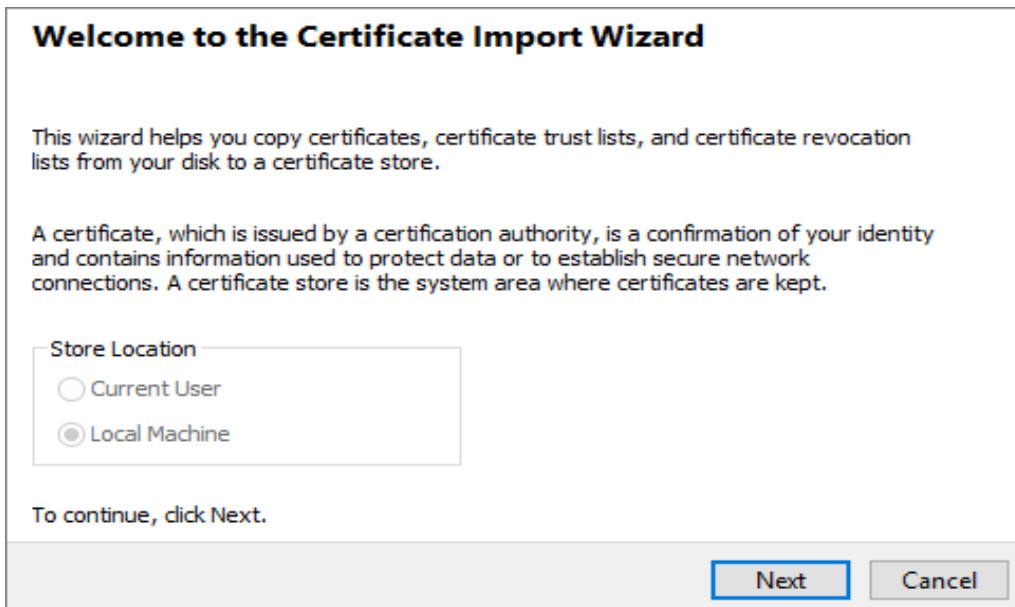

Click **Browse...**, and locate the .p12 file you downloaded earlier. Then, click **Next**.

**File to Import**  
Specify the file you want to import.

---

File name:  
C:\Users\ZyXEL\Desktop\default.p12 **Browse...**

Note: More than one certificate can be stored in a single file in the following formats:  
Personal Information Exchange- PKCS #12 (.PFX,.P12)  
Cryptographic Message Syntax Standard- PKCS #7 Certificates (.P7B)  
Microsoft Serialized Certificate Store (.SST)

**Next** **Cancel**

Type **zyx123** in the **Password** field and click **Next**.

**Private key protection**  
To maintain security, the private key was protected with a password.

---

Type the password for the private key.

Password:  
zyx123  
 Display Password

Import options:

Enable strong private key protection. You will be prompted every time the private key is used by an application if you enable this option.

Mark this key as exportable. This will allow you to back up or transport your keys at a later time.

Include all extended properties.

**Next** **Cancel**



Select **Place all certificates in the following store** and then click **Browse** and find **Trusted Root Certification Authorities**. Click **Next**, then click **Finish**.

**Certificate Store**  
Certificate stores are system areas where certificates are kept.

---

Windows can automatically select a certificate store, or you can specify a location for the certificate.

Automatically select the certificate store based on the type of certificate

Place all certificates in the following store

Certificate store:  
Trusted Root Certification Authorities

 Note: Each ZyWALL/USG device has its own self-signed certificate by factory default. When you reset to default configuration file, the original self-signed certificate is erased, and a new self-signed certificate will be created when the ZyWALL/USG boots the next time.

## Set Up the L2TP VPN Tunnel on the Windows 10

To configure L2TP VPN in Windows 10 operating system, go to **Start > Settings > Network & Internet > VPN > Add a VPN Connection** and configure as follows.

**VPN Provider** set to **Windows (built-in)**.

Configure **Connection name** for you to identify the VPN configuration.

Set **Server** name or address to be the ZyWALL/USG's WAN IP address (172.124.163.150 in this example).

Select **VPN type** to **Layer 2 Tunneling Protocol with IPsec (L2TP/IPsec)**.

Enter **User name** and **Password** which the same as **Allowed User** created in ZyWALL/USG (L2TP\_Remote\_Users/zyx168 in this example).

**Add a VPN connection**

VPN provider  
Windows (built-in) ▾

Connection name  
ZyXEL\_L2TP\_VPN

Server name or address  
172.124.163.150

VPN type  
Layer 2 Tunneling Protocol with IPsec (L2TP/I) ▾

Type of sign-in info  
User name and password ▾

User name (optional)  
L2TP\_Remote\_Users

Password (optional)  
••••••

Remember my sign-in info

Save Cancel

Go to **Control Panel > Network and Internet > Network Connections** and right click **Properties**. Continue to **Security > Advanced settings** and select **Use Certificate for authentication**.

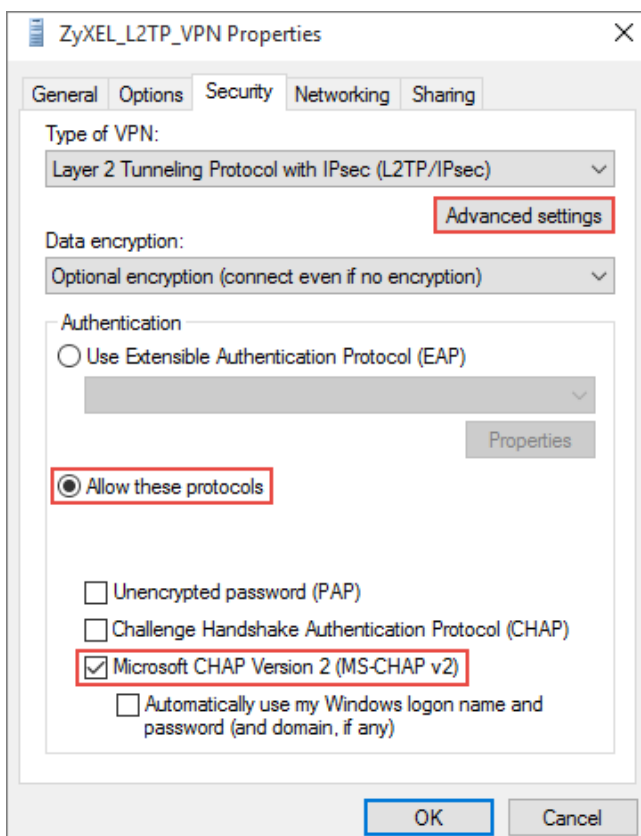
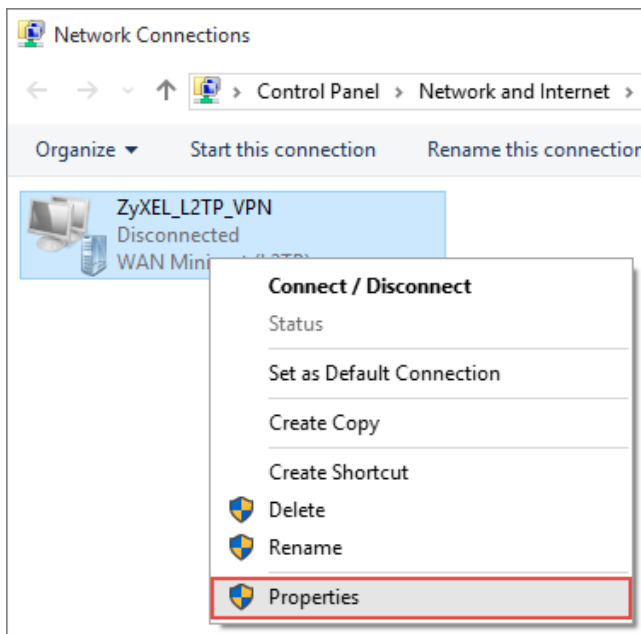

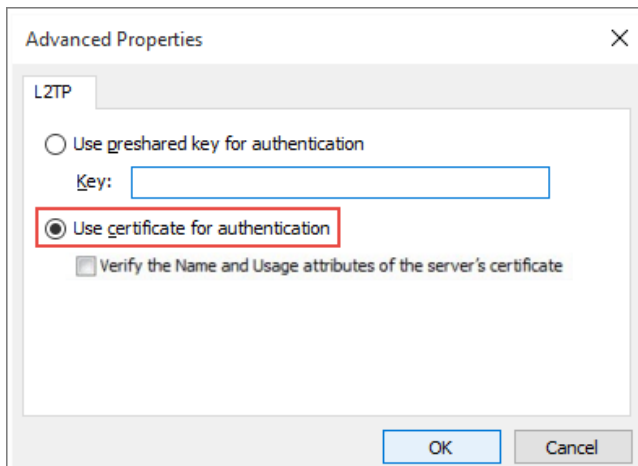

Go to **Network & Internet Settings** window, click **Connect**.

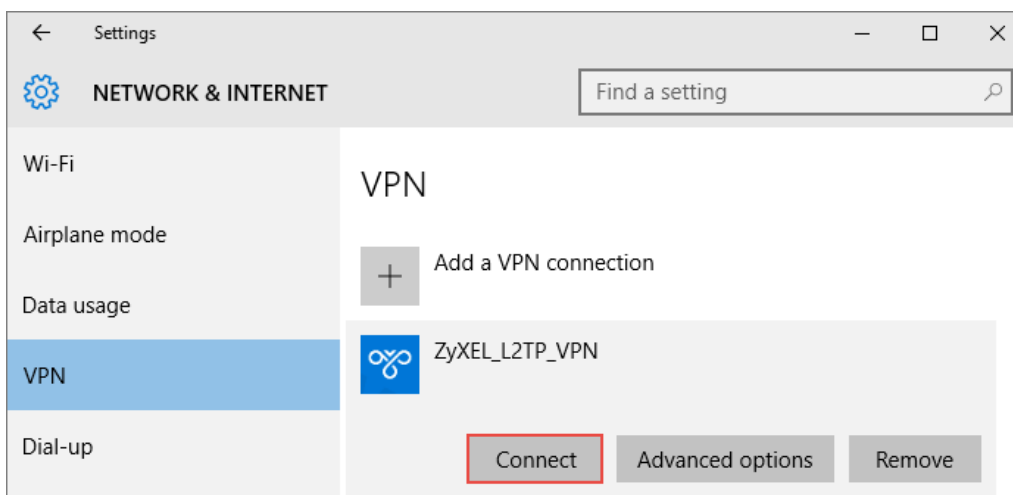

## Test the L2TP over IPsec VPN Tunnel

Go to ZyWALL/USG **CONFIGURATION > VPN > IPsec VPN > VPN Connection**, the **Status** connect icon is lit when the interface is connected.

### CONFIGURATION > VPN > IPsec VPN > VPN Connection



#	Status	Name	VPN Gateway	Policy
1		WIZ_L2TP_VPN	WIZ_L2TP_VPN	<a href="#">WIZ_L2TP_VPN_LOCAL/</a>

Go to ZyWALL/USG **MONITOR > VPN Monitor > IPsec** and verify the tunnel **Up Time** and the **Inbound(Bytes)/Outbound(Bytes)** traffic. Click **Connectivity Check** to verify the result of ICMP Connectivity.

### Hub\_HQ > MONITOR > VPN Monitor > IPsec > WIZ\_L2TP\_VPN

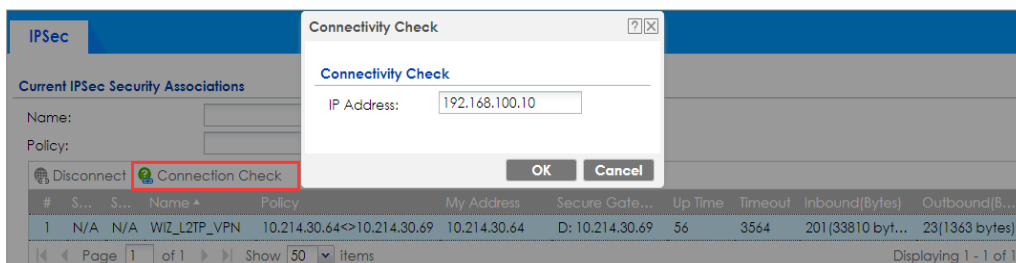

The screenshot shows the IPsec configuration page with a 'Connectivity Check' dialog box open. The dialog box has an 'IP Address' field containing '192.168.100.10' and 'OK' and 'Cancel' buttons. Below the dialog, a table lists VPN connections with columns for Name, Policy, My Address, Secure Gate..., Up Time, Timeout, Inbound(Bytes), and Outbound(B...).

#	S...	S...	Name	Policy	My Address	Secure Gate...	Up Time	Timeout	Inbound(Bytes)	Outbound(B...
1	N/A	N/A	WIZ_L2TP_VPN	10.214.30.64<->10.214.30.69	10.214.30.64	D: 10.214.30.69	56	3564	201(33810 byt...	23(1363 bytes)

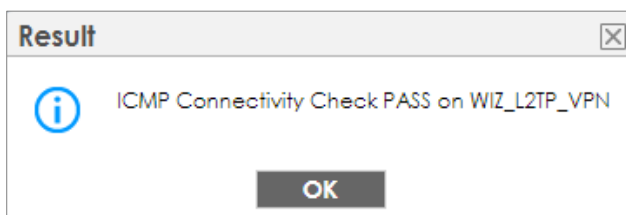

The screenshot shows a 'Result' dialog box with an information icon and the text 'ICMP Connectivity Check PASS on WIZ\_L2TP\_VPN'. There is an 'OK' button at the bottom.

Go to ZyWALL/USG **MONITOR > VPN Monitor > L2TP over IPsec** and verify the **Current L2TP Session**.

### MONITOR > VPN Monitor > L2TP over IPsec > L2TP\_Remote\_Users

Current L2TP Session

Disconnect Refresh

#	User Name	Hostname	Assigned IP	Public IP
1	L2TP_Remote_Users	ellen-PC	192.168.100.10	10.214.30.69

Page 1 of 1 Show 50 items Displaying 1 - 1 of 1

Go to Window 10 operating system **Start > Settings > Network & Internet > VPN** and show **Connected** status.

**Menu > Settings > VPN > ZyXEL\_L2TP**

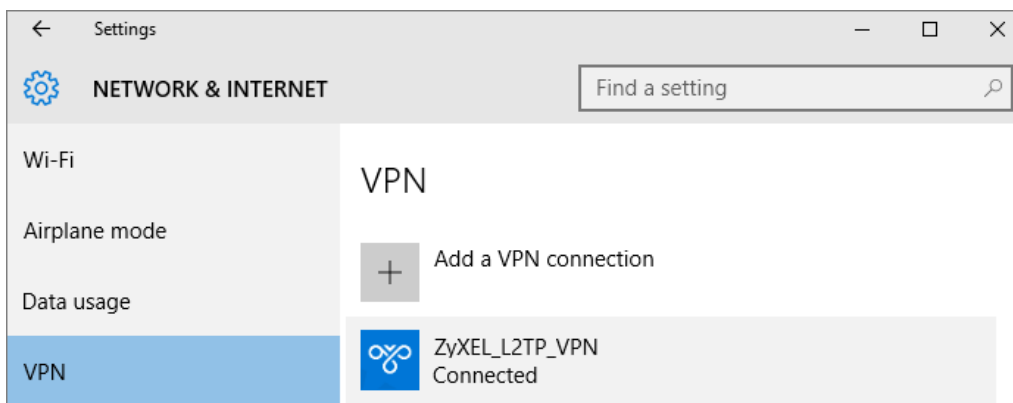

## What Could Go Wrong?

If you see [alert] log message such as below, please check ZyWALL/USG L2TP Allowed User or User/Group Settings. Windows 10 users must use the same Username and Password as configured in ZyWALL/USG to establish the L2TP VPN.

#	Priority	Category	Message	Note
13	alert	L2TP Over IPSec	User L2TP_Remote_Users has been denied from L2TP service.(Incorrect Username or Password)	L2TP_LOG

If you see [info] or [error] log message such as below, please check ZyWALL/USG Phase 1 Settings. Windows 10 operating system users must use the same Pre-Shared Key as configured in ZyWALL/USG to establish the IKE SA.

#	Priority	Category	Message	Note
2	info	IKE	ISAKMP SA [WIZ_L2TP_VPN] is disconnected	IKE_LOG
3	info	IKE	The cookie pair is : 0xd103273f03f379a0 / 0x05efd54196dc6cd6	IKE_LOG
10	info	IKE	Send:[NOTIFY:INVALID_PAYLOAD_TYPE]	IKE_LOG
11	info	IKE	Invalid payload type in encrypted payload chain, possibly because of different pre-shared keys	IKE_LOG

If you see that Phase 1 IKE SA process has completed but still get [info] log message as below, please check ZyWALL/USG Phase 2 Settings. ZyWALL/USG unit must set correct **Local Policy** to establish the IKE SA.

Priority	Category	Message	Note
info	IKE	Send:[HASH][NOTIFY:NO_PROPOSAL_CHOSEN]	IKE_LOG
info	IKE	[SA] : No proposal chosen	IKE_LOG
info	IKE	[ID] : Tunnel [WIZ_L2TP_VPN] Phase 2 Local policy mismatch	IKE_LOG

Ensure that the L2TP Address Pool does not conflict with any existing LAN1, LAN2, DMZ, or WLAN zones, even if they are not in use.

If you cannot access devices in the local network, verify that the devices in the local network set the USG's IP as their default gateway to utilize the L2TP tunnel.

Make sure the ZyWALL/USG units' security policies allow IPSec VPN traffic. IKE uses UDP port 500, AH uses IP protocol 51, and ESP uses IP protocol 50.





Verify that the Zone is set correctly in the VPN Connection rule. This should be set to IPSec\_VPN Zone so that security policies are applied properly.

## How to Import ZyWALL/USG Certificate for L2TP over IPsec in IOS mobile phone

This is an example of using the L2TP VPN and VPN client software included in Android mobile phone operating systems. When the VPN tunnel is configured, users can securely access the network behind the ZyWALL/USG and allow traffic from L2TP clients to go to the Internet from an iOS mobile phone.

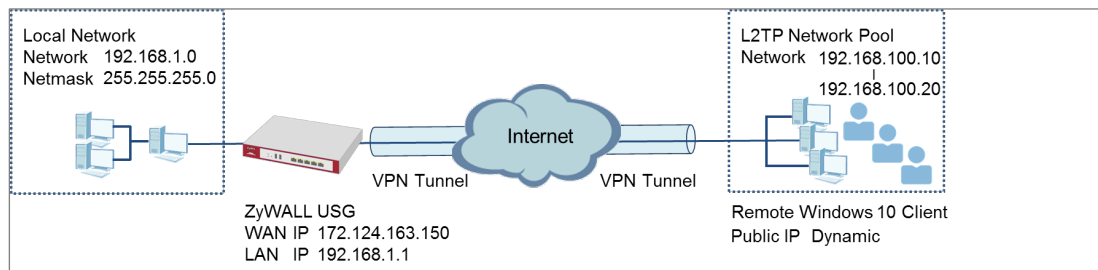
### ZyWALL/USG L2TP VPN with Remote iOS Mobile Phone Client Example



 Note: All network IP addresses and subnet masks are used as examples in this article. Please replace them with your actual network IP addresses and subnet masks. This example was tested using USG310 (Firmware Version: 4.25) and iOS (Version: 10.0.10240)

## Set Up the L2TP VPN Tunnel on the ZyWALL/USG

In the ZyWALL/USG, go to **Quick Setup > VPN Setup Wizard**, use the **VPN Settings for L2TP VPN Settings** wizard to create a **L2TP VPN** rule that can be used with the iOS mobile phone clients. Click **Next**.

**Quick Setup > VPN Setup Wizard > Welcome**

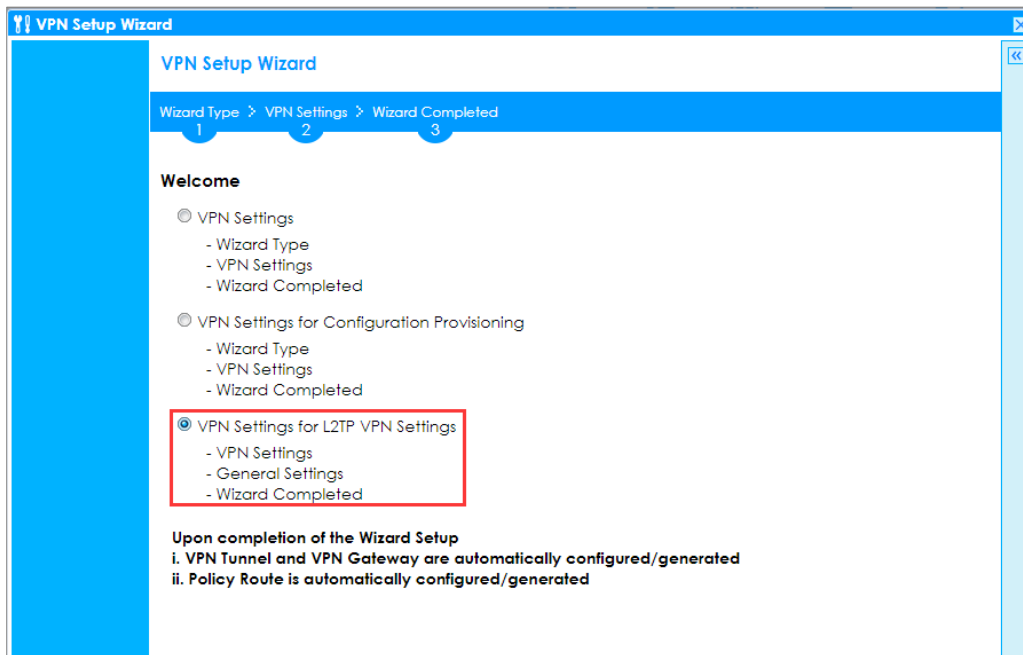

Then, configure the **Rule Name** and set **My Address** to be the **wan1** interface which is connected to the Internet. Type a secure **Pre-Shared Key** (8-32 characters).

**Quick Setup > VPN Setup Wizard > Welcome > VPN Settings**

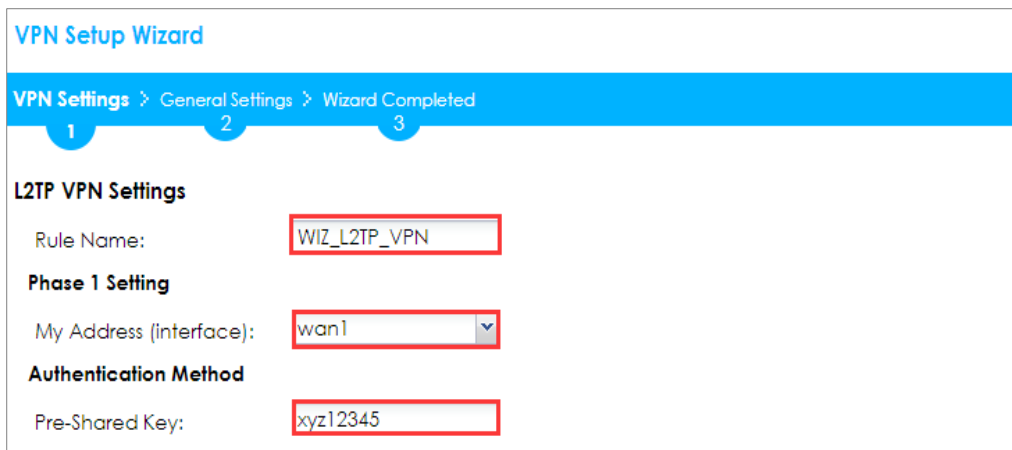

Assign the L2TP users' IP address range from 192.168.100.10 to 192.168.100.20 for use in the L2TP VPN tunnel and select **Allow L2TP traffic Through WAN** to allow traffic from L2TP clients to go to the Internet. Click **OK**.

**Quick Setup > VPN Setup Wizard > Welcome > VPN Settings (L2TP VPN Settings)**

**VPN Setup Wizard**

[VPN Settings](#) > [General Settings](#) > [Wizard Completed](#)

1
2
3

**L2TP VPN Settings**

IP Address Pool: RANGE i

Starting IP Address: 192.168.100.10

End IP Address: 192.168.100.20

First DNS Server (Optional):

Second DNS Server (Optional):

Allow L2TP traffic Through WAN

This screen provides a read-only summary of the VPN tunnel. Click **Save**.

**Quick Setup > VPN Setup Wizard > Welcome > VPN Settings (Summary)**

**VPN Setup Wizard**

[Wizard Type](#) > [VPN Settings](#) > [Wizard Completed](#)

1
2
3

**Express Settings**

**Summary**

Rule Name:	WIZ_L2TP_VPN
Secure Gateway:	Any
Pre-Shared Key:	xyz12345
My Address (interface):	wan1
IP Address Pool:	RANGE, 192.168.10.10 - 192.168.10.20

Now the rule is configured on the ZyWALL/USG. The rule settings appear in the **VPN > L2TP VPN** screen. Click **Close** to exit the wizard.

**Quick Setup > VPN Setup Wizard > Welcome > VPN Settings > Wizard Completed**

### VPN Setup Wizard

Wizard Type > VPN Settings > Wizard Completed

1
2
3

#### Express Settings

##### Summary

Rule Name:	WIZ_L2TP_VPN
Secure Gateway:	Any
Pre-Shared Key:	xyz12345
My Address (interface):	wan1
IP Address Pool:	RANGE, 192.168.10.10 - 192.168.10.20

Go to **CONFIGURATION > VPN > VPN Gateway > WIZ\_L2TP\_VPN**, change **Authentication** method to be **Certificate** and select the certificate which ZyWALL/USG uses to identify itself to the Android mobile phone.

**CONFIGURATION > VPN > VPN Gateway > WIZ\_L2TP\_VPN > Authentication > Certificate**

#### Authentication

Pre-Shared Key .....  
 unmasked

Certificate default ▼ (See [My Certificates](#))

User Based PSK admin ▼ ⓘ

Go to **CONFIGURATION > VPN > L2TP VPN > Create new Object > User** to add **User Name** and **Password** (4-24 characters). Then, set **Allowed User** to the newly created object (L2TP\_Remote\_Users/zyx168 in this example).

**CONFIGURATION > VPN > L2TP VPN > Create new Object > User**

**L2TP VPN**

Show Advanced Settings Create new Object

User

General Settings Configuration Walkthrough Address Troubleshooting

Enable L2TP Over IPsec

VPN Connection: WIZ\_L2TP\_VPN

IP Address Pool: WIZ\_L2TP\_VPN\_IP\_1 RANGE, 192.168.100.10-192.168.100.20

Authentication Method: default local

Advance

Allowed User: any

Keep Alive Timer: 60 (1-180 seconds)

First DNS Server (Optional): Custom Defined

Second DNS Server (Optional): Custom Defined

First WINS Server (Optional):

Second WINS Server (Optional):

Add A User

User Configuration

User Name: L2TP\_Remote\_Users

User Type: user

Password: \*\*\*\*\*

Retype: \*\*\*\*\*

Description: Local User

Authentication Timeout Settings  Use Default Settings  Use Manual Settings

Lease Time: 1440 minutes

Reauthentication Time: 1440 minutes

OK Cancel

**L2TP VPN**

Show Advanced Settings Create new Object

General Settings Configuration Walkthrough Troubleshooting

Enable L2TP Over IPsec

VPN Connection: WIZ\_L2TP\_VPN

IP Address Pool: WIZ\_L2TP\_VPN\_IP\_1 RANGE, 192.168.100.10-192.168.100.20

Authentication Method: default local

Advance

Allowed User: any

Keep Alive Timer: 60 (1-180 seconds)

First DNS Server (Optional): Custom Defined

Second DNS Server (Optional): Custom Defined

First WINS Server (Optional):

Second WINS Server (Optional):

any

any

=== Object ===

ad-users

admin

ldap-users

radius-users

ua-users

L2TP\_Remote\_Users

## Export a Certificate from ZyWALL/USG and Import it to iOS Mobile Phone

Go to ZyWALL/USG **CONFIGURATION > Object > Certificate**, select the certificate (**default** in this example) and click **Edit**.

### CONFIGURATION > Object > Certificate > default

#	Name	Type	Subject	Issuer	Valid From	Valid To
1	default	SELF	CN=vpn50_B8ECA31E2398	CN=vpn50_B8ECA31E2398	2017-01-07 10:19:45 GMT	2027-01-05 10:19:45 GMT

Export default certificate from ZyWALL/USG with Private Key (zyx123 in this example)

### CONFIGURATION > Object > Certificate > default > Edit > Export Certificate with Private Key

Save **default** certificate as **\*.p12** file to Android mobile phone computer.



default.p12

## Set Up the L2TP VPN Tunnel on the iOS Mobile Device

- 1 To configure L2TP VPN in iOS operating system, go to **Start > Settings > Network & Internet > VPN > Add a VPN Connection** and configure as follows.
- 2 VPN Provider set to Windows (built-in).
- 3 Configure **Connection name** for you to identify the VPN configuration.

- 4 Set **Server** name or address to be the ZyWALL/USG's WAN IP address (172.124.163.150 in this example).
- 5 Select VPN type to Layer 2 Tunneling Protocol with IPsec (L2TP/IPsec).
- 6 Enter **User name** and **Password** which the same as **Allowed User** created in ZyWALL/USG (L2TP\_Remote\_Users/zyx168 in this example).

**Add a VPN connection**

VPN provider  
Windows (built-in) ▾

Connection name  
ZyXEL\_L2TP\_VPN

Server name or address  
172.124.163.150

VPN type  
Layer 2 Tunneling Protocol with IPsec (L2TP/I ▾

Type of sign-in info  
User name and password ▾

User name (optional)  
L2TP\_Remote\_Users

Password (optional)  
•••••

Remember my sign-in info

Save Cancel

- 7 Go to Control Panel > Network and Internet > Network Connections and right click Properties. Continue to Security > Advanced settings and select Use Certificate for authentication.



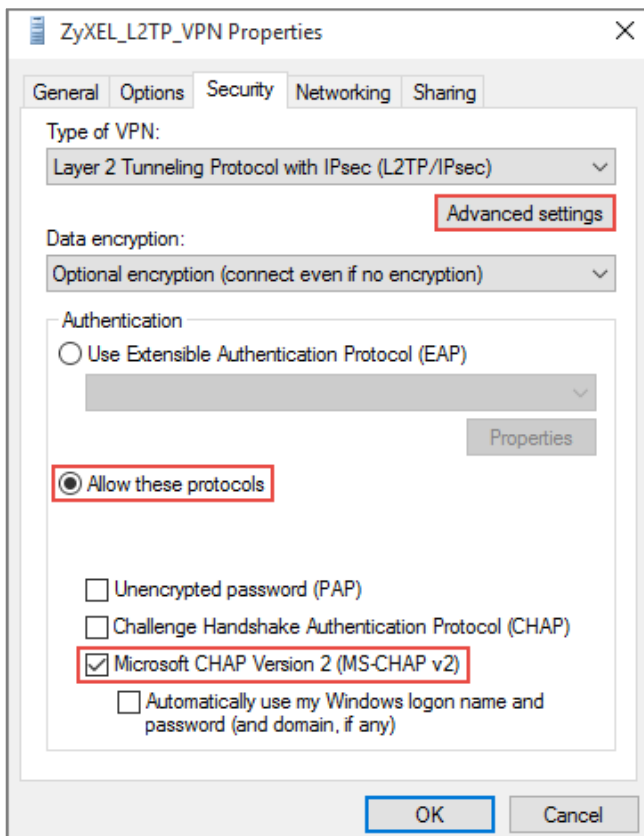
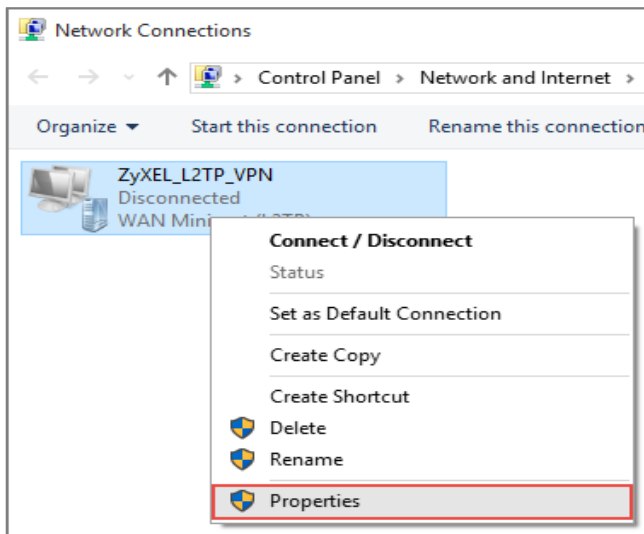

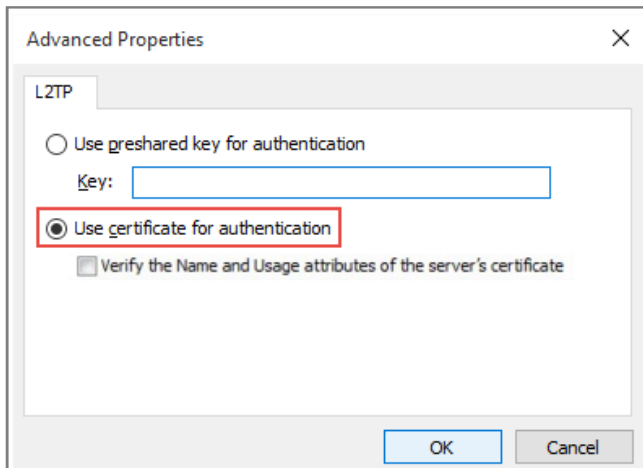

- 8 Go to Network & Internet Settings window, click Connect.

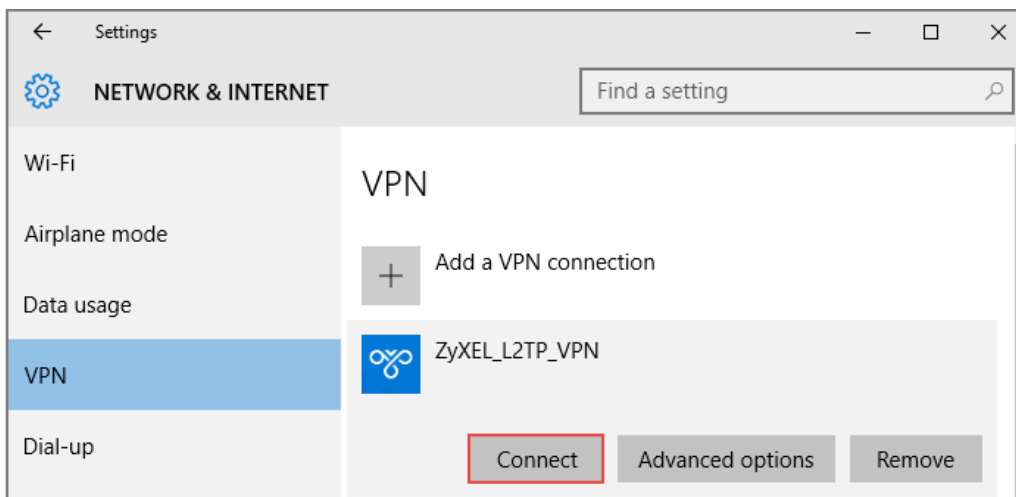

## Test the L2TP over IPSec VPN Tunnel

1. Go to ZyWALL/USG **CONFIGURATION > VPN > IPSec VPN > VPN Connection**, the **Status** connect icon is lit when the interface is connected.

### CONFIGURATION > VPN > IPSec VPN > VPN Connection



- Go to ZyWALL/USG **MONITOR > VPN Monitor > IPSec** and verify the tunnel **Up Time** and the **Inbound(Bytes)/Outbound(Bytes)** traffic. Click **Connectivity Check** to verify the result of ICMP Connectivity.

**Hub\_HQ > MONITOR > VPN Monitor > IPSec > WIZ\_L2TP\_VPN**

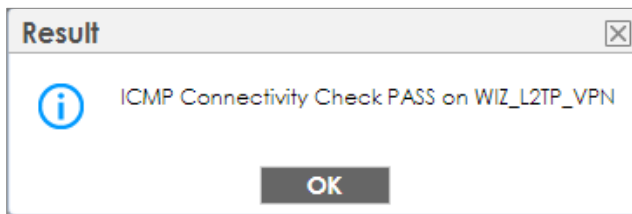
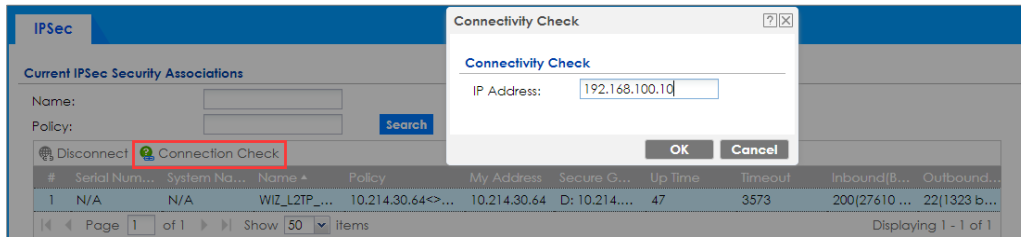

- Go to ZyWALL/USG **MONITOR > VPN Monitor > L2TP over IPSec** and verify the **Current L2TP Session**.

**MONITOR > VPN Monitor > L2TP over IPSec > L2TP\_Remote\_Users**

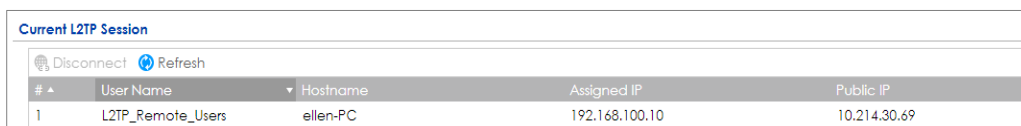

- Go to iOS operating system **Start > Settings > Network & Internet > VPN** and show **Connected** status.

**Menu > Settings > VPN > ZyXEL\_L2TP**

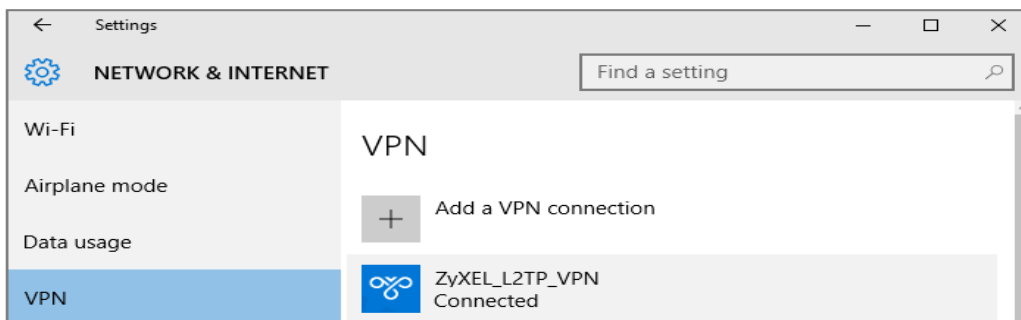

## What Could Go Wrong?

1. If you see [alert] log message such as below, please check ZyWALL/USG L2TP Allowed User or User/Group Settings. iOS users must use the same Username and Password as configured in ZyWALL/USG to establish the L2TP VPN.

#	Ti...	Priority	Category	Message	Note
1	2...	info	IKE	ISAKMP SA [WIZ_L2TP_VPN] is disconnected	IKE_LOG
2	2...	info	IKE	Send:[HASH][DEL] [count=6]	IKE_LOG
3	2...	info	IKE	Tunnel [WIZ_L2TP_VPN:WIZ_L2TP_VPN:0xa8aad2b4] is disconnected	IKE_LOG
4	2...	alert	L2TP Over IPSec	User L2TP_Remote_Users has been denied from L2TP service.(Incorrect Username or Password)	L2TP_LOG

2. If you see [info] or [error] log message such as below, please check ZyWALL/USG Phase 1 Settings. iOS users must use the same Pre-Shared Key as configured in ZyWALL/USG to establish the IKE SA.

Priority	Category	Message	Note
info	IKE	Send:[NOTIFY:INVALID_PAYLOAD_TYPE]	IKE_LOG
info	IKE	Invalid payload type in encrypted payload chain, possibly because of different pre-shared keys	IKE_LOG

3. If you see that Phase 1 IKE SA process has completed but still get [info] log message as below, please check ZyWALL/USG Phase 2 Settings. ZyWALL/USG unit must set correct **Local Policy** to establish the IKE SA.

Priority	Category	Message	Note
info	IKE	ISAKMP SA [WIZ_L2TP_VPN] is disconnected	IKE_LOG
info	IKE	Received delete notification	IKE_LOG
info	IKE	Recv:[HASH][DEL]	IKE_LOG
info	IKE	Send:[HASH][NOTIFY:NO_PROPOSAL_CHOSEN]	IKE_LOG
info	IKE	[SA] : No proposal chosen	IKE_LOG
info	IKE	[ID] : Tunnel [WIZ_L2TP_VPN] Phase 2 Local policy mismatch	IKE_LOG

4. Ensure that the L2TP Address Pool does not conflict with any existing LAN1, LAN2, DMZ, or WLAN zones, even if they are not in use.
5. If you cannot access devices in the local network, verify that the devices in the local network set the USG's IP as their default gateway to utilize the L2TP tunnel.

6. Make sure the ZyWALL/USG units' security policies allow IPSec VPN traffic. IKE uses UDP port 500, AH uses IP protocol 51, and ESP uses IP protocol 50.
7. Verify that the Zone is set correctly in the VPN Connection rule. This should be set to IPSec\_VPN Zone so that security policies are applied properly.

## How to Configure 2 factor for VPN connection?

This example shows how to use two-factor authentication to have double-layer security to access a secured network behind the Zyxel Device via a VPN tunnel between a ZyWALL/USG and a ZyWALL IPsec VPN Client. The first layer is the VPN client user name / password and the second layer is an authorized SMS (via mobile phone number) or email address.

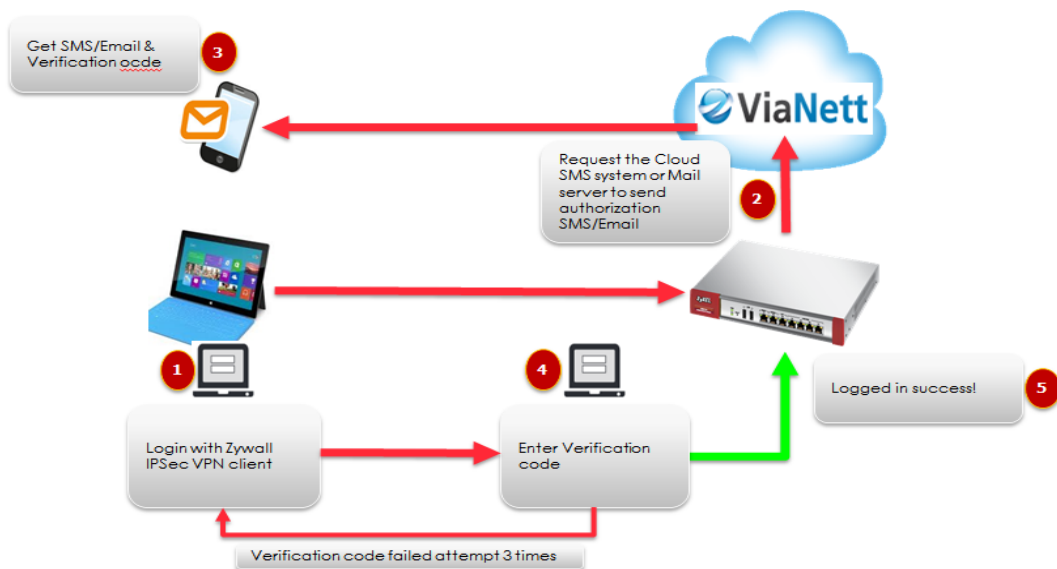

### Walkthrough

1. Set up the ZyWALL/USG IPsec VPN Tunnel on USG
2. Set up the ZyWALL IPsec VPN Client on windows client.
3. Set up notification for email and SMS message sending.
4. Enable 2 factor authentications for VPN service.

## Set up the ZyWALL/USG IPSec VPN Tunnel

In the ZyWALL/USG, go to **CONFIGURATION > Quick Setup > VPN Setup Wizard**, use the **VPN Settings for Configuration Provisioning** wizard to create a VPN rule that can be used with the ZyWALL IPSec VPN Client. Click **Next**.

### Quick Setup > VPN Setup Wizard > Welcome

**VPN Setup Wizard**

Wizard Type > VPN Settings > Wizard Completed  
1 2 3

**Welcome**

- VPN Settings
  - Wizard Type
  - VPN Settings
  - Wizard Completed
- VPN Settings for Configuration Provisioning**
  - Wizard Type
  - VPN Settings
  - Wizard Completed
- VPN Settings for L2TP VPN Settings
  - VPN Settings
  - General Settings
  - Wizard Completed

Choose **Express** to create a VPN rule with the default phase 1 and phase 2 settings and use a pre-shared key to be the authentication method. Click **Next**.

### Quick Setup > VPN Setup Wizard > Wizard Type

**VPN Setup Wizard**

Wizard Type > VPN Settings > Wizard Completed  
1 2 3

Please select the type of VPN policy you wish to setup.

**Type of VPN policy**

- Express**
- Advanced

Type the **Rule Name** used to identify this VPN connection (and VPN gateway). You may use 1-31 alphanumeric characters. This value is case-sensitive. Click **Next**.

## Quick Setup > VPN Setup Wizard > Welcome > Wizard Type > VPN Settings-1

**VPN Setup Wizard**

Wizard Type > **VPN Settings** > Wizard Completed

1 2 3

**Express Settings**

**Scenario**

Rule Name:

Application Scenario: Remote Access (Server Role)

Type a secure **Pre-Shared Key** (8-32 characters). Set **Local Policy** to be the IP address range of the network connected to the ZyWALL/USG.

## Quick Setup > VPN Setup Wizard > Welcome > Wizard Type > VPN Settings-2

**VPN Setup Wizard**

Wizard Type > **VPN Settings** > Wizard Completed

1 2 3

**Express Settings**

**Configuration**

Secure Gateway: Any

Pre-Shared Key:

Local Policy (IP/Mask):  /

Remote Policy (IP/Mask): Any

This screen provides a read-only summary of the VPN tunnel. Click **Save**.

## Quick Setup > VPN Setup Wizard > Welcome > Wizard Type > VPN Settings-3

**VPN Setup Wizard**

Wizard Type > **VPN Settings** > Wizard Completed

1      2      3

**Express Settings**

**Summary**

Rule Name:	WIZ_VPN_PROVISIONING
Secure Gateway:	Any
Pre-Shared Key:	zyx12345
Local Policy (IP/Mask):	192.168.1.0 / 255.255.255.0
Remote Policy (IP/Mask):	Any

Now the rule is configured on the ZyWALL/USG. The Phase 1 rule settings appear in the **VPN > IPSec VPN > VPN Gateway** screen and the Phase 2 rule settings appear in the **VPN > IPSec VPN > VPN Connection** screen. Click **Close** to exit the wizard.

**Quick Setup > VPN Setup Wizard > Welcome > Wizard Type > VPN Settings > Wizard Completed**

**VPN Setup Wizard**

Wizard Type > VPN Settings > **Wizard Completed**

1      2      3

**Express Settings**

Congratulations. The VPN Access wizard is completed

**Summary**

Rule Name:	WIZ_VPN_PROVISIONING
Secure Gateway:	Any
Pre-Shared Key:	zyx12345
Local Policy (IP/Mask):	192.168.1.0 / 255.255.255.0
Remote Policy (IP/Mask):	Any

Go to **CONFIGURATION > VPN > IPSec VPN > VPN connection**. Enable **Mode config** for IPSec VPN client connection, create address object



**Add Address Rule**

Name:

Address Type:

Starting IP Address:

End IP Address:

OK Cancel

Select the address object for mode config VPN IP address Pool.

**Edit VPN Connection WIZ\_VPN\_PROVISIONING**

Hide Advanced Settings Create new Object

Enable Mode Config

IP Address Pool:  RANGE, 192.168.99.10-192.168.99.100

First DNS Server (Optional):

Second DNS Server (Optional):

First WINS Server (Optional):

Second WINS Server (Optional):

Phase 2 Setting

OK Cancel

Go to **CONFIGURATION > Object > User/Group > Add A User** and create a user account for the ZyWALL IPSec VPN Client user. Type one or more valid email addresses and valid mobile telephone number for this user so that messages can be sent to this user for 2 factor authentication.

**CONFIGURATION > Object > User/Group > Add A User**

Go to **CONFIGURATION > VPN > IPsec VPN > Gateway**, enable X-Auth for VPN client authentication.

Go to **CONFIGURATION > VPN > IPsec VPN > Configuration Provisioning**. In the **General Settings** section, select the **Enable Configuration Provisioning**. Then, go to

the **Configuration** section and click **Add** to bind a configured **VPN Connection** to **Allowed User**. Click **Activate** and **Apply** to save the configuration.

## CONFIGURATION > VPN > IPSec VPN > Configuration Provisioning

**General Settings**

Enable Configuration Provisioning

**Authentication**

Client Authentication Method: default

**Configuration**

Buttons: Add, Edit, Remove, Activate, Inactivate, Move

#	Status	Priority	Type	VPN Connection	Allowed User
1	On	1	4in4	WIZ_VPN_PROVISIONING	Remote_Client

Page 1 of 1 | Show 50 items | Displaying 1 - 1 of 1

Buttons: Apply, Reset

## Set up the ZyWALL IPSec VPN Client

Download **ZyWALL IPSec VPN Client** software from ZyXEL Download Library:

[http://www.zyxel.com/support/download\\_landing.shtml](http://www.zyxel.com/support/download_landing.shtml)

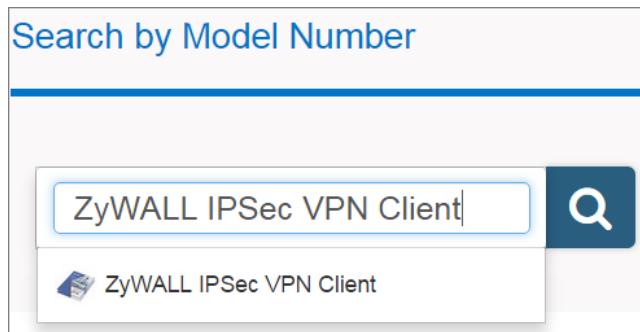

Open ZyWALL IPSec VPN Client, select **CONFIGURATION > Get from Server**.

**CONFIGURATION > Get from Server**

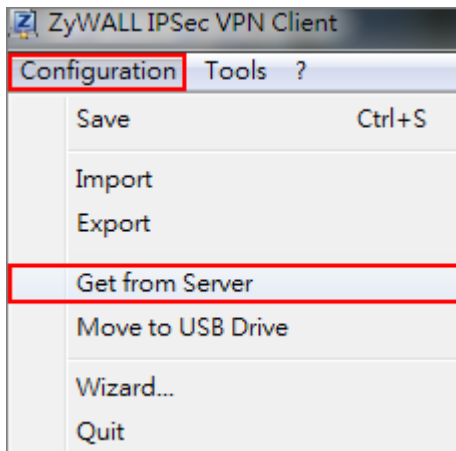

Enter the WAN IP address or URL for the ZyWALL/USG in the **Gateway Address**. If you changed the default HTTPS **Port** on the ZyWALL/USG, and then enter the new one here. Enter the **Login** user name and **Password** exactly as configured on the ZyWALL or external authentication server. Click **Next**, you will see it's processing VPN configuration from the server.

**CONFIGURATION > Get from Server > Step 1: Authentication**

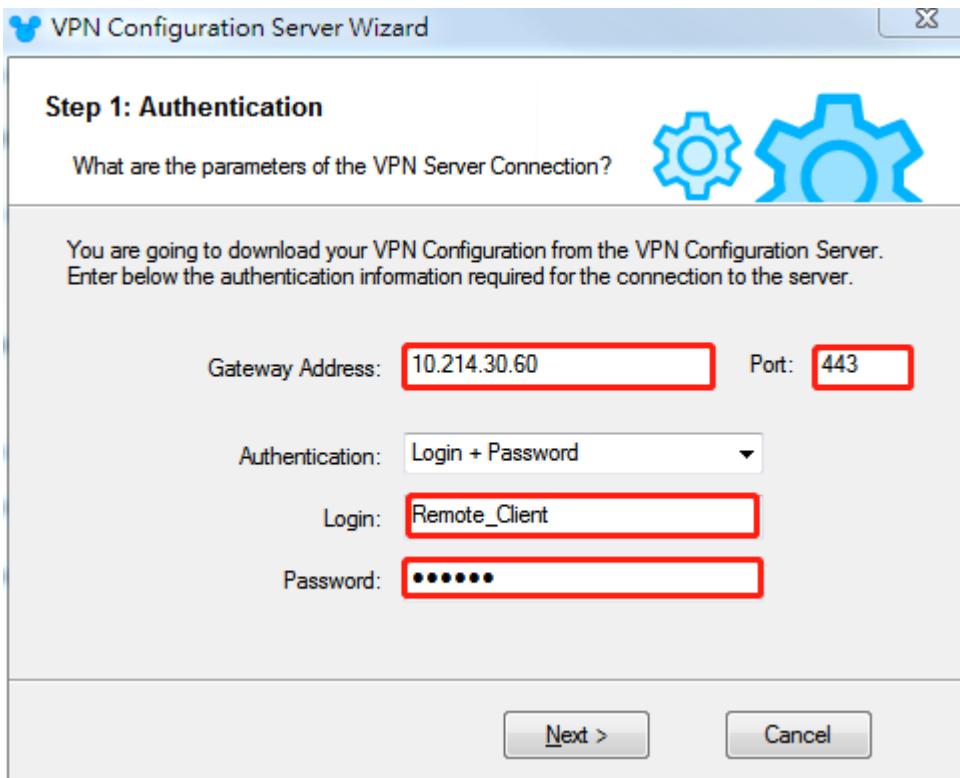

**VPN Configuration Server Wizard**

### Step 1: Authentication

What are the parameters of the VPN Server Connection?

You are going to download your VPN Configuration from the VPN Configuration Server. Enter below the authentication information required for the connection to the server.

Gateway Address:  Port:

Authentication:

Login:

Password:

## CONFIGURATION > Get from Server > Step 2: Processing

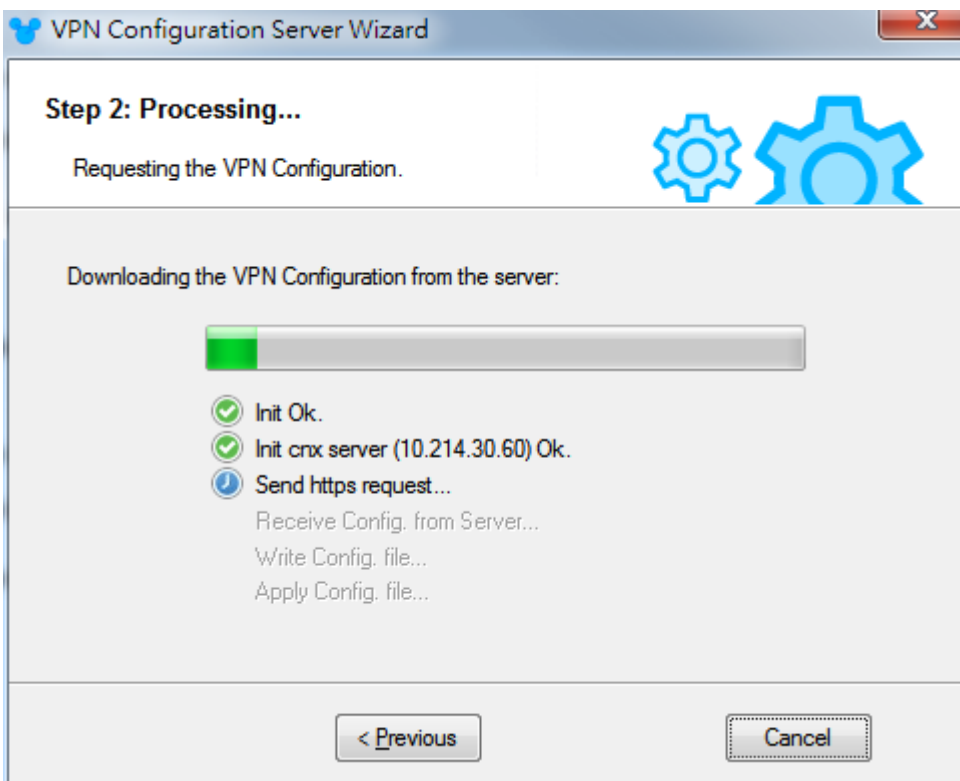

**VPN Configuration Server Wizard**

### Step 2: Processing...

Requesting the VPN Configuration.

Downloading the VPN Configuration from the server:

- Init Ok.
- Init cnx server (10.214.30.60) Ok.
- Send https request...
  - Receive Config. from Server...
  - Write Config. file...
  - Apply Config. file...

Then, you will see the **Configuration successful** page, click **OK** to exit the wizard.

## CONFIGURATION > Get from Server > Configuration successful

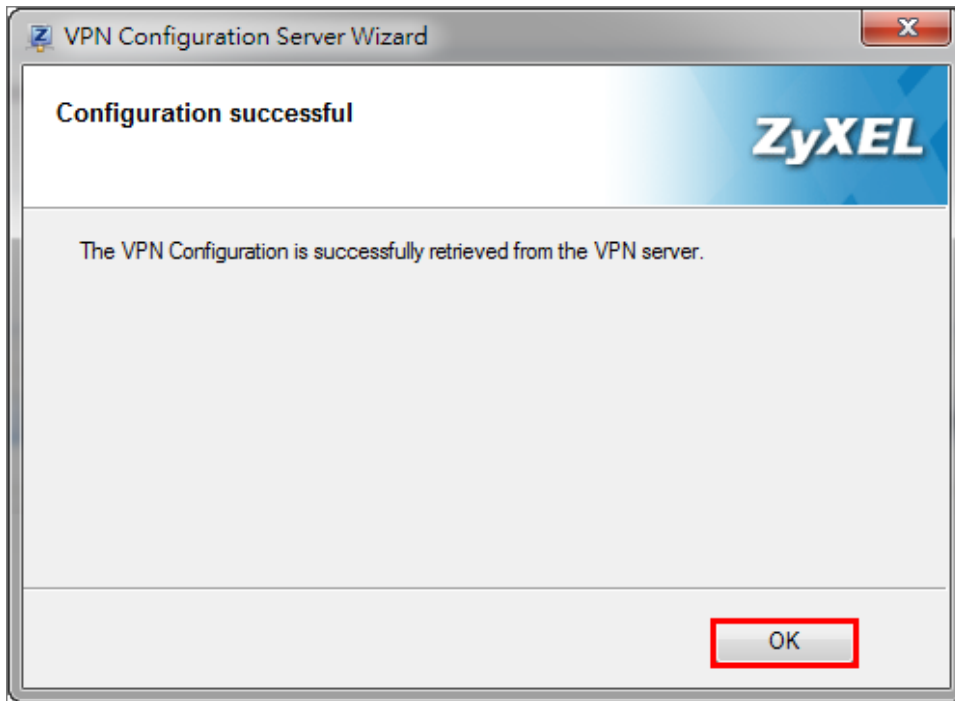

**VPN CONFIGURATION > IKE V1 > WIZ\_VPN\_PROVISIONING > Advanced**, type Login account and password for authentication.

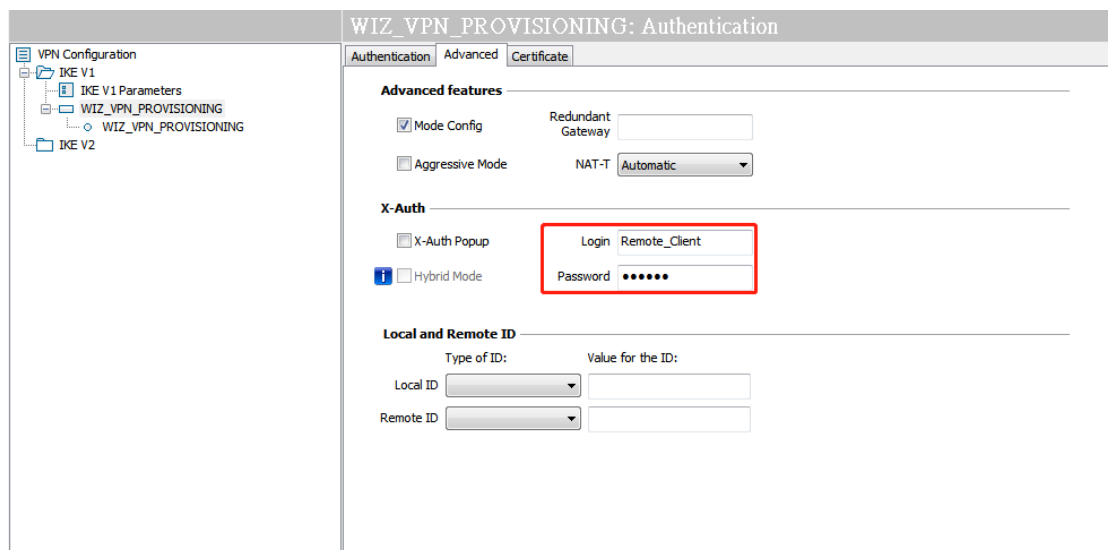

## Set up notification for 2 factor authentication

In the ZyWALL/USG, go to **CONFIGURATION > System > Notification > Mail Server**

1. Type the name or IP address of the SMTP server.
2. Enter the service port for SMTP.
3. Type the e-mail address from which the outgoing e-mail is delivered.
4. Select this check box if it is necessary to provide a user name and password to the SMTP server.
5. Click **“Apply”** button to save your changes to the Zyxel Device.

The screenshot shows the 'Mail Server' configuration page in the ZyXel web interface. The 'General Settings' section includes the following fields and options:

- Mail Server:** smtp.pchome.com.tw (Outgoing SMTP Server Name or IP Address)
- Mail Subject:**  Append system name  Append date time
- Mail Server Port:** 25  TLS Security  STARTTLS  Authenticate Server
- Mail From:** cooldia@pchome.com.tw (Email Address)
- SMTP Authentication**
- User Name:** cooldia
- Password:** [masked with dots]
- Retype to Confirm:** [masked with dots]

The **Schedule** section shows 'Time For Sending Report' set to 0 (hours) 0 (minutes).

Go to 2<sup>nd</sup> tab **CONFIGURATION > System > Notification > SMS**, in this scenario, we will use email and SMS for 2 factor authentication.

1. Select the check box “Enable SMS” to turn on the SMS service.
2. Enter the default country code for the mobile phone number to which you want to send SMS messages.
3. Enter the user name and password for your ViaNett account.
4. Click **“Apply”** button to save your changes to the Zyxel Device.

The screenshot shows the ZyXEL web interface for SMS configuration. It has two tabs: 'Mail Server' and 'SMS'. The 'SMS' tab is active. Under 'General Settings', there is a checked checkbox for 'Enable SMS' and a text field for 'Default country code for phone number' containing '886'. Below this is a section for 'Purchase SMS Voucher from Zyxel reseller' with a link to 'zyxel.vianett.com'. The 'ViaNet Configuration' section contains three fields: 'User Name' with the value 'pd000245', 'Password', and 'Retype to Confirm', both masked with dots.

## Set up authentication for 2 factor VPN connection

In the ZyWALL/USG, go to **CONFIGURATION > Object > Auth.Method > Two-factor Authentication**.

1. Select the check box **"Enable"** to enable 2 factor authentications.
2. Enter the maximum time (in minutes) that the user must click or tap the authorization link in the SMS or email in order to get authorization for the VPN connection.
3. Select which kinds of VPN tunnels require Two-Factor Authentication. in this scenario, we enable 2 factor authentication on IPSec VPN Access
4. This list displays the names of the users and user groups that can be selected for two-factor authentication.
5. Use this section to configure how to send an SMS or email for authorization.  
We select both methods in this scenario.
6. Configure the link that the user will receive in the SMS or email. The user must be able to access the link.
7. You can either create a default message in the text box or upload a message file (Use Multilingual file) from your computer.
8. Click **"Apply"** button to save your changes to the ZyXel Device.



**General Settings**

Enable

Valid Time:  (1-15 minutes)

Two-factor Authentication for Services:

SSL VPN Access  IPsec VPN Access  L2TP/IPsec VPN Access

---

**User/Group**

Selectable User/Group Objects

admin  
ldap-users  
radius-users  
ad-users  
test

Selected User/Group Objects

any

---

**Delivery Settings**

Deliver Authorize Link Method:  SMS  Email

Authorize Link URL Address:    (Domain Name or IP Address) i

Message:  Use Default Message  Use Multilingual file

<users>. You have initiated a VPN connection to a secured network behind the <hosts>. Please click or tap the following link within <time> minutes to get authorization for the VPN connection. <url>

Apply    Reset

## Test the Result

Go to **VPN Configuration > IKEv1**, right click the **WIZ\_VPN\_PROVISIONING** and select **Open tunnel**. You will see the **Tunnel opened** on ZyWALL IPsec VPN client

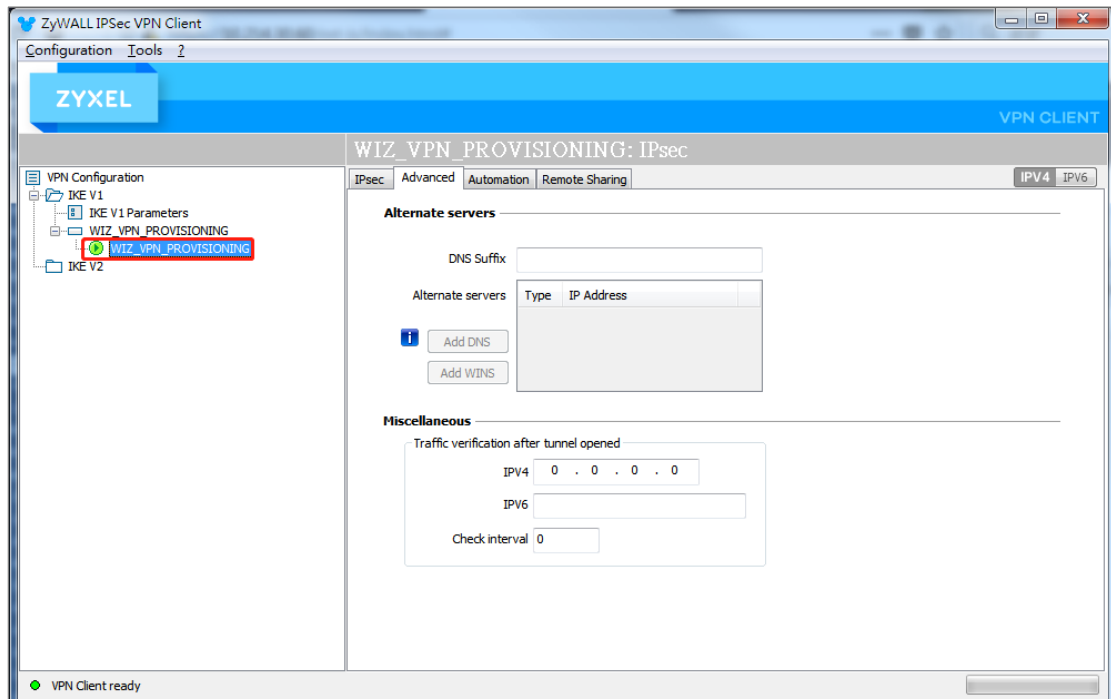

The VPN tunnel is created from the ZyWALL IPsec VPN client to the ZyWALL/USG, but we are still unable to access Intranet behind the ZyWALL/USG. The ZyWALL/USG send authorized link via phone number or email address in order to authenticate this user's

use of the VPN tunnel (factor 2). If user does not click the link, then the Zyxel Device terminates the VPN connection. The client should access the authorization link sent via SMS or email by the Cloud SMS system within a specified deadline (Valid Time). If the authorization is correct and received on time, then the client can have VPN access to the secured network. If the authorization deadline has expired, then the client will have to run the VPN client again. If authorization credentials are incorrect or if the SMS/email was not received, then the client must check with the network administrator.

The following is authorized example by email and SMS

### Authorized by email link

1. Received authorization mail with authorize link.

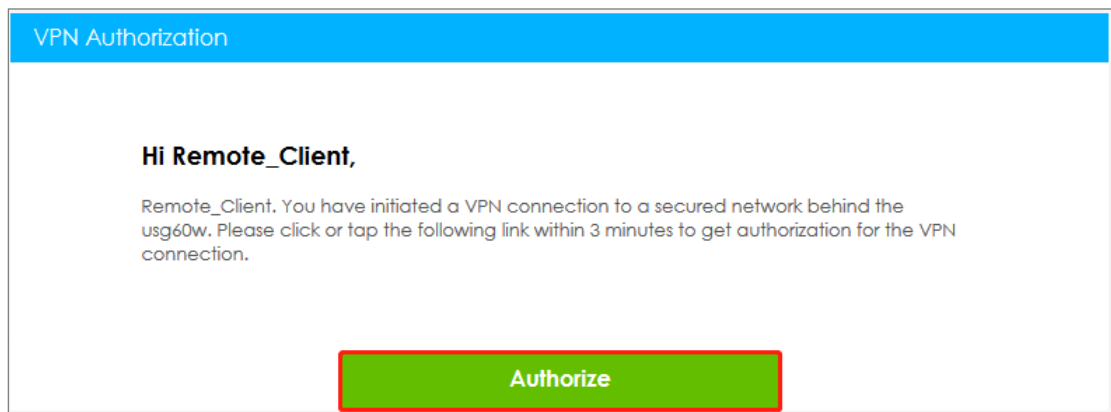

2. Click the "**Authorize**" to authorization.

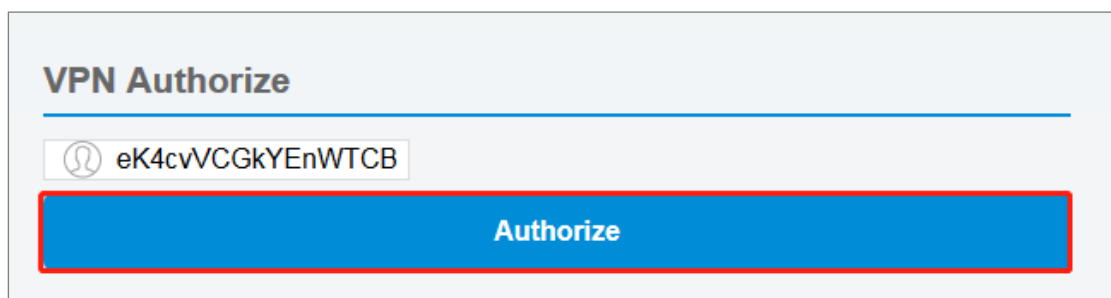

3. After we see "**VPN connection has been authorized**", we can access the secured network behind the ZyWALL/USG.

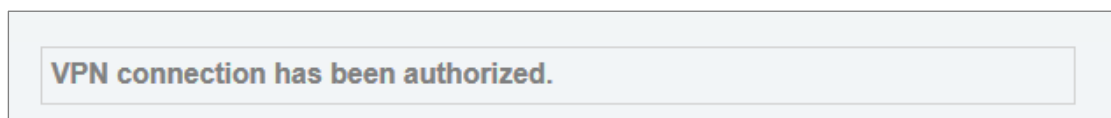

## Authorized by SMS

1. Received authorization SMS with authorize link.

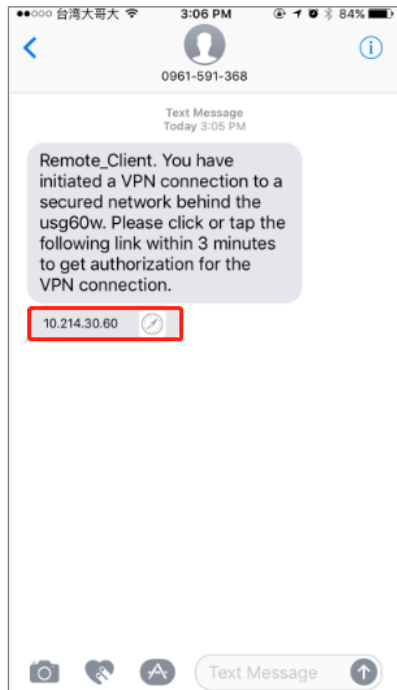

2. Click the SMS link to authorized, after we see "VPN connection has been authorized", we can access the secured network behind the ZyWALL/USG.

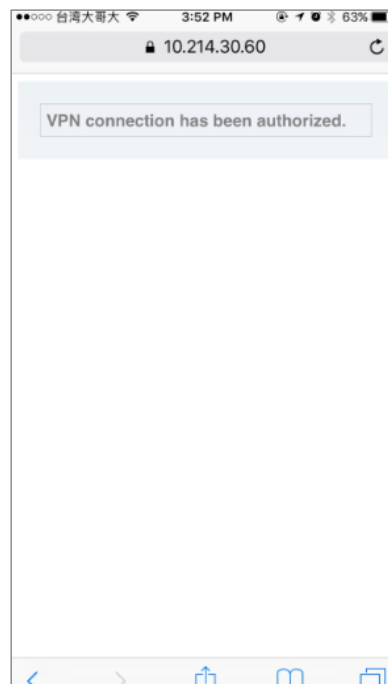
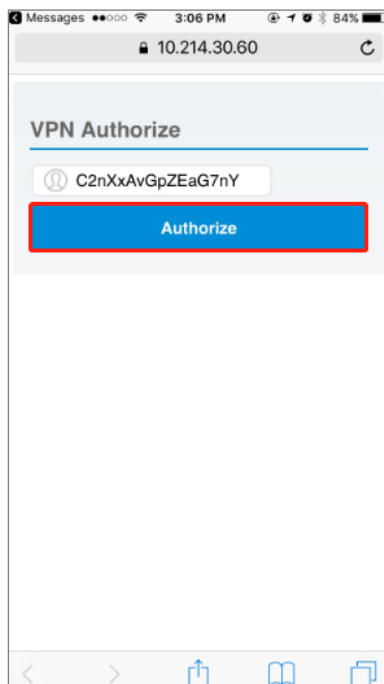

## What could went wrong

If you see below log message "**Mail server authentication failed.**", please check "**CONFIGURATION > System > Notification > SMTP Server**", Make sure your password is correct for mail authentication

### MONITOR > Log

#	Time	Priority	Category	Message	Source	Destination	Note
1	2018-07-27 ...	error	System	Mail server authentication failed.			
2	2018-07-27 ...	info	Authenticat...	send E-mail to user: Remote_Client, email:coo*****t...			two-factor ...

If you see below log message "**Cannot resolve mail server address smtp.pchome.com.t'**" please check "**CONFIGURATION > System > Notification > SMTP Server**", Make sure your service IP/hostname is correct for mail authentication.

### MONITOR > Log

#	Time	Priority	Category	Message	Source	Destination	Note
1	2018-07-27 ...	error	System	Cannot resolve mail server address smtp.pchome.com.t.			
2	2018-07-27 ...	info	Authenticat...	send E-mail to user: Remote_Client, email:coo*****t...			two-factor ...

If you are unable to received SMS for authorization, please check "**CONFIGURATION > System > Notification > SMS**", confirm the country code is correct for SMS message **CONFIGURATION > System > Notification > SMS**

**General Settings**

Enable SMS

Default country code for phone number:  (1-4) digit

[Purchase SMS Voucher from Zyxel reseller](#)

## How to Import ZyWALL/USG Certificate for L2TP over IPsec in Android mobile phone

This is an example of using the L2TP VPN and VPN client software included in Android mobile phone operating systems. When the VPN tunnel is configured, users can securely access the network behind the ZyWALL/USG and allow traffic from L2TP clients to go to the Internet from an Android mobile phone.

ZyWALL/USG L2TP VPN with Remote Android Mobile Phone Client Example

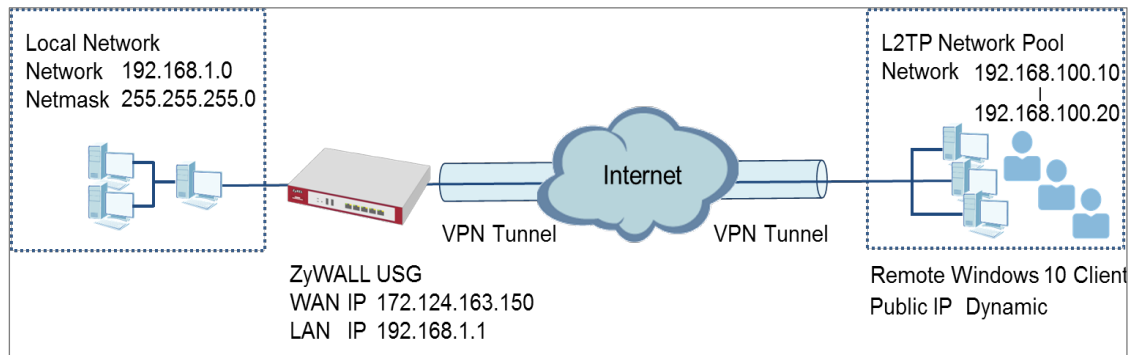

Note: All network IP addresses and subnet masks are used as examples in this article. Please replace them with your actual network IP addresses and subnet masks. This example was tested using USG310 (Firmware Version: 4.25) and Android (Version: 10.0.10240)

## Set Up the L2TP VPN Tunnel on the ZyWALL/USG

In the ZyWALL/USG, go to **Quick Setup > VPN Setup Wizard**, use the **VPN Settings for L2TP VPN Settings** wizard to create a **L2TP VPN** rule that can be used with the Android mobile phone clients. Click **Next**.

### Quick Setup > VPN Setup Wizard > Welcome

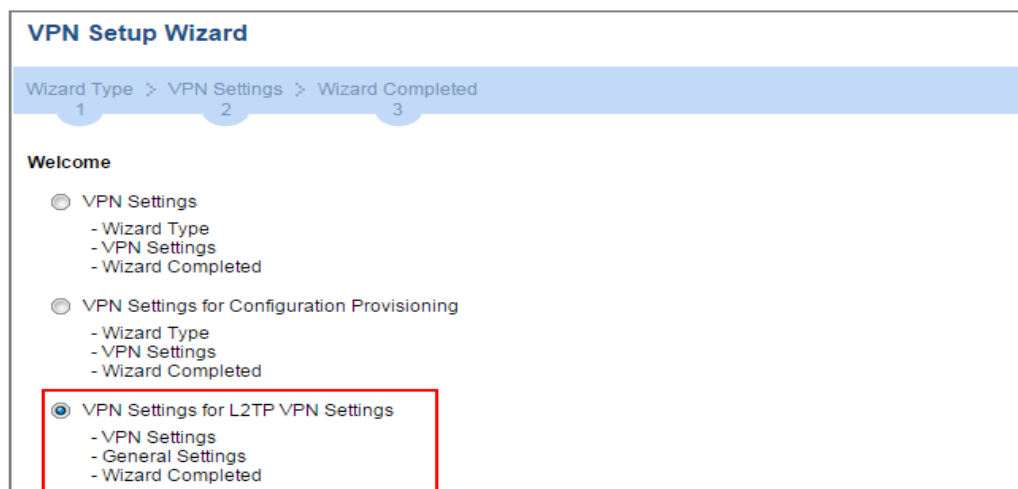

Then, configure the **Rule Name** and set **My Address** to be the **wan1** interface which is connected to the Internet. Type a secure **Pre-Shared Key** (8-32 characters).

**Quick Setup > VPN Setup Wizard > Welcome > VPN Settings**

**VPN Setup Wizard**

**VPN Settings** > General Settings > Wizard Completed

1 2 3

**L2TP VPN Settings**

Rule Name:

**Phase 1 Setting**

My Address (interface):

**Authentication Method**

Pre-Shared Key:

Assign the L2TP users' IP address range from 192.168.100.10 to 192.168.100.20 for use in the L2TP VPN tunnel and select **Allow L2TP traffic Through WAN** to allow traffic from L2TP clients to go to the Internet. Click **OK**.

**Quick Setup > VPN Setup Wizard > Welcome > VPN Settings (L2TP VPN Settings)**

**VPN Setup Wizard**

**VPN Settings** > General Settings > Wizard Completed

1 2 3

**L2TP VPN Settings**

IP Address Pool:  ⓘ

Starting IP Address:

End IP Address:

First DNS Server (Optional):

Second DNS Server (Optional):

Allow L2TP traffic Through WAN

This screen provides a read-only summary of the VPN tunnel. Click **Save**.

**Quick Setup > VPN Setup Wizard > Welcome > VPN Settings (Summary)**



Now the rule is configured on the ZyWALL/USG. The rule settings appear in the **VPN > L2TP VPN** screen. Click **Close** to exit the wizard.

**Quick Setup > VPN Setup Wizard > Welcome > VPN Settings > Wizard Completed**

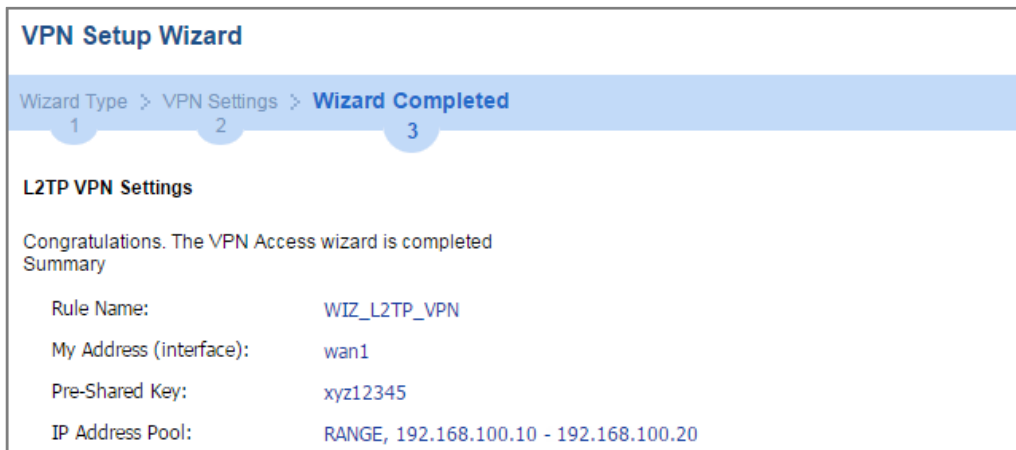

Go to **CONFIGURATION > VPN > VPN Gateway > WIZ\_L2TP\_VPN**, change **Authentication** method to be **Certificate** and select the certificate which ZyWALL/USG uses to identify itself to the Android mobile phone.

CONFIGURATION > VPN > VPN Gateway > WIZ\_L2TP\_VPN > Authentication >

## Certificate

**Authentication**

Pre-Shared Key

unmasked

Certificate **default** (See [My Certificates](#))

User Based PSK

Go to **CONFIGURATION > VPN > L2TP VPN > Create new Object > User** to add **User Name** and **Password** (4-24 characters). Then, set **Allowed User** to the newly created object (L2TP\_Remote\_Users/zyx168 in this example).

CONFIGURATION > VPN > L2TP VPN > Create new Object > User

**Add A User**

**User Configuration**

User Name : **L2TP\_Remote\_Users**

User Type: user

Password: \*\*\*\*\*

Retype: \*\*\*\*\*

Description: Local User

**L2TP VPN**

Show Advanced Settings

**General Settings**

Enable L2TP Over IPSec

VPN Connection: WIZ\_L2TP\_VPN

IP Address Pool: WIZ\_L2TP\_VPN\_IP\_ADDRESS  RANGE, 192.168.100.10-192.168.100.20

Authentication Method: default local

Allowed User: any

Keep Alive Timer: 60 (1-180 seconds)



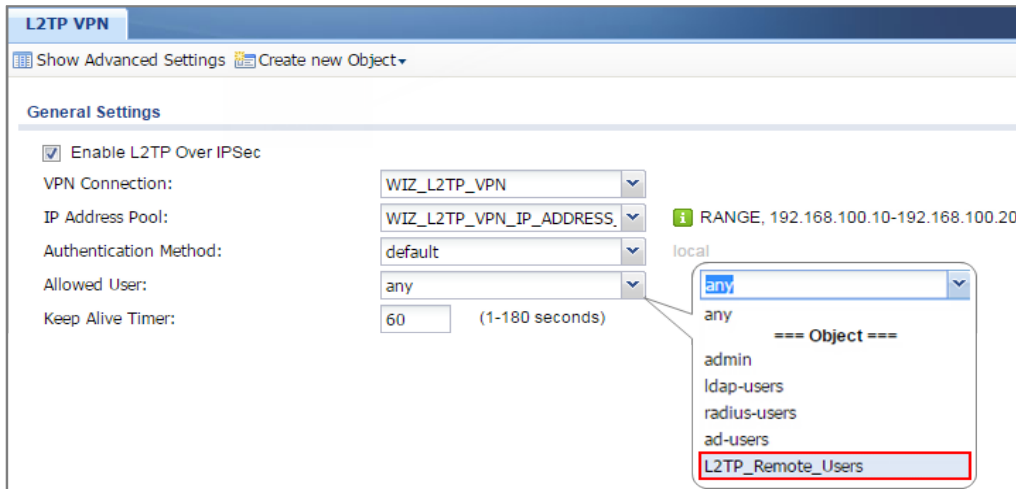

## Export a Certificate from ZyWALL/USG and Import it to Android Mobile Phone

Go to ZyWALL/USG **CONFIGURATION > Object > Certificate**, select the certificate (**default** in this example) and click **Edit**.

**CONFIGURATION > Object > Certificate > default**

My Certificates Setting						
#	Name	Type	Subject	Issuer	Valid From	Valid To
1	default	SELF	CN=usg110_107BEFD11B50	CN=usg110_107BEFD11B50	2014-02-19 11:29:28 GMT	2024-02-17 11:29:28 GMT

Export default certificate from ZyWALL/USG with Private Key (zyx123 in this example)

**CONFIGURATION > Object > Certificate > default > Edit > Export Certificate with Private Key**

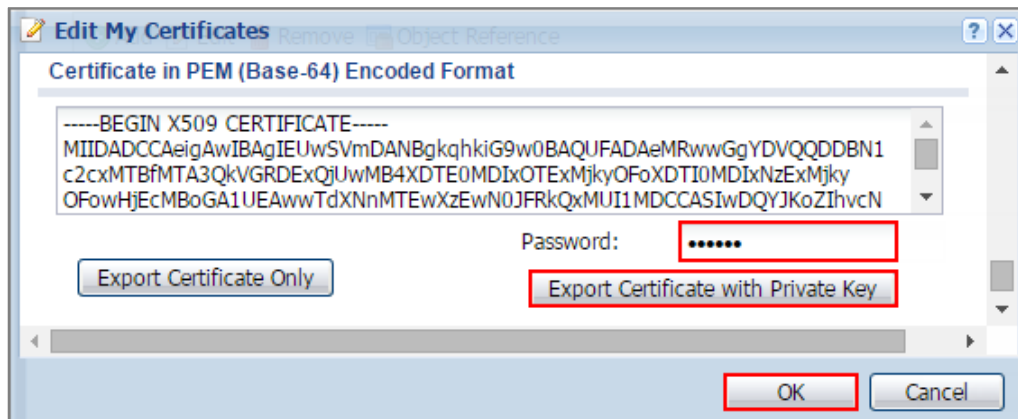

Save **default** certificate as **\*.p12** file to Android mobile phone computer.



default.p12

## Set Up the L2TP VPN Tunnel on the Android Mobile Device

- 1 To configure L2TP VPN in Android, go to Start > Settings > Network & Internet > VPN > Add a VPN Connection and configure as follows.
- 2 VPN Provider set to Windows (built-in).
- 3 Configure **Connection name** for you to identify the VPN configuration.
- 4 Set **Server** name or address to be the ZyWALL/USG's WAN IP address (172.124.163.150 in this example).

- 5 Select VPN type to Layer 2 Tunneling Protocol with IPsec (L2TP/IPsec).
  
- 6 Enter **User name** and **Password** which the same as **Allowed User** created in ZyWALL/USG (L2TP\_Remote\_Users/zyx168 in this example).

**Add a VPN connection**

VPN provider  
Windows (built-in) ▾

Connection name  
ZyXEL\_L2TP\_VPN

Server name or address  
172.124.163.150

VPN type  
Layer 2 Tunneling Protocol with IPsec (L2TP/I) ▾

Type of sign-in info  
User name and password ▾

User name (optional)  
L2TP\_Remote\_Users

Password (optional)  
••••••

Remember my sign-in info

Save Cancel

Go to **Control Panel > Network and Internet > Network Connections** and right click **Properties**. Continue to **Security > Advanced settings** and select **Use Certificate for authentication**.

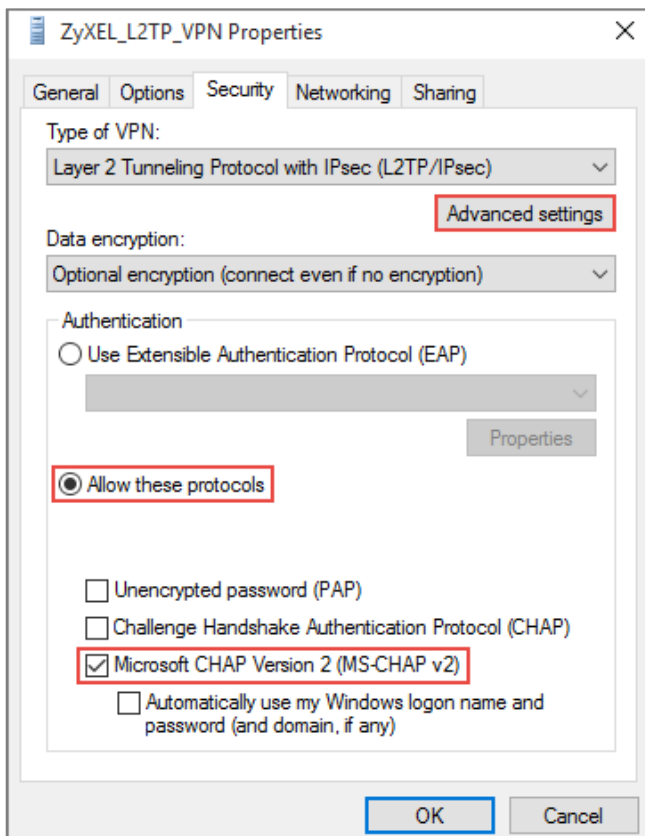
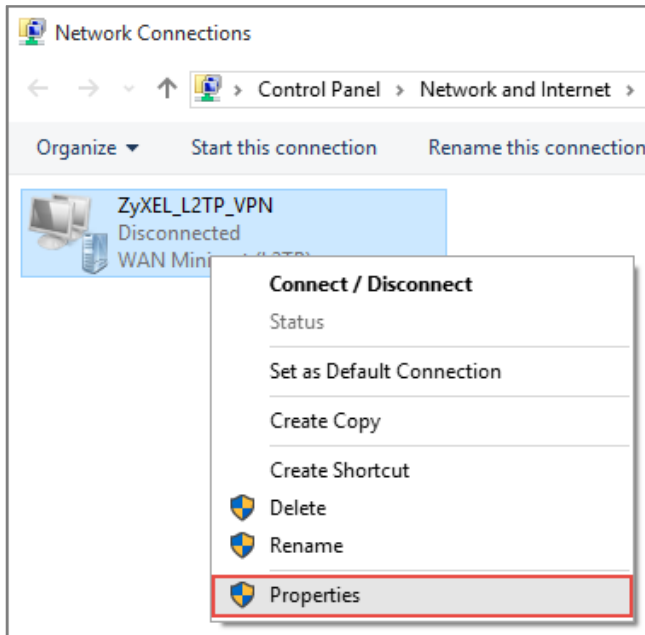

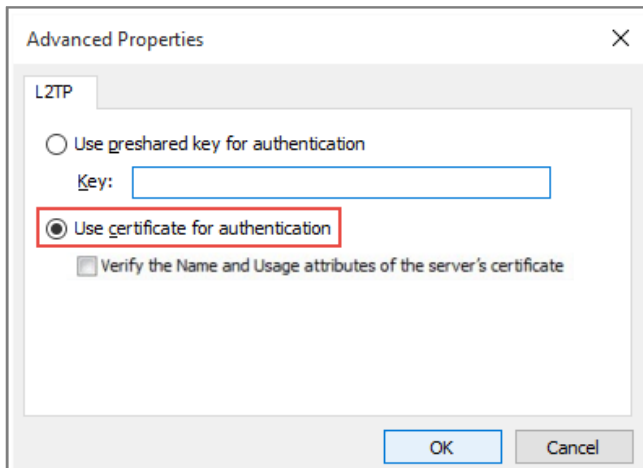

Go to **Network & Internet Settings** window, click **Connect**.

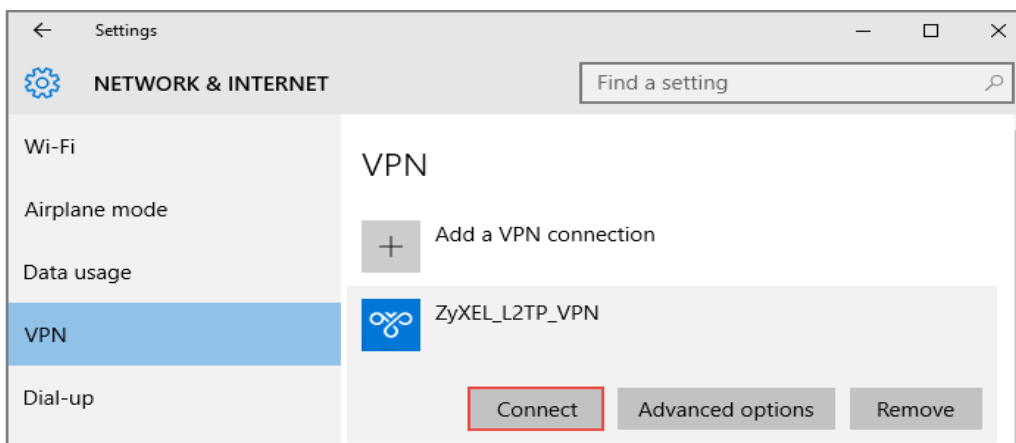

## Test the L2TP over IPSec VPN Tunnel

Go to ZyWALL/USG **CONFIGURATION > VPN > IPSec VPN > VPN Connection**, the **Status** connect icon is lit when the interface is connected.

### CONFIGURATION > VPN > IPSec VPN > VPN Connection

IPv4 Configuration				
#	Status	Name	VPN Gateway	Policy
1		WIZ_L2TP_VPN	WIZ_L2TP_VPN	WIZ_L2TP_VPN_LOCAL/

Go to ZyWALL/USG **MONITOR > VPN Monitor > IPSec** and verify the tunnel **Up Time** and the **Inbound(Bytes)/Outbound(Bytes)** traffic. Click **Connectivity Check** to verify the result of ICMP Connectivity.

**Hub\_HQ > MONITOR > VPN Monitor > IPSec > WIZ\_L2TP\_VPN**

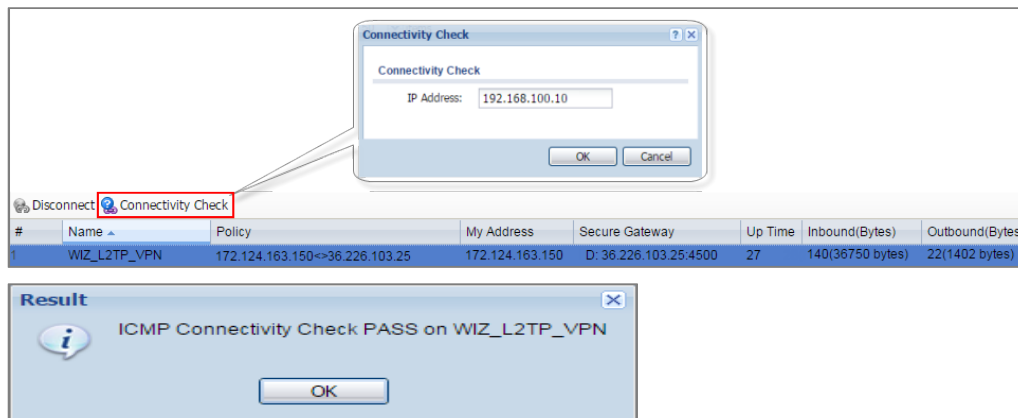

Go to ZyWALL/USG **MONITOR > VPN Monitor > L2TP over IPSec** and verify the **Current L2TP Session**.

**MONITOR > VPN Monitor > L2TP over IPSec > L2TP\_Remote\_Users**

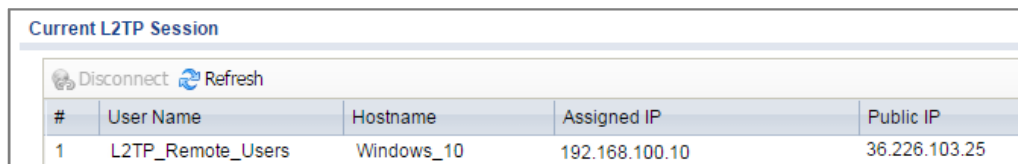

Go to Android **Start > Settings > Network & Internet > VPN** and show **Connected** status.

**Menu > Settings > VPN > ZyXEL\_L2TP**

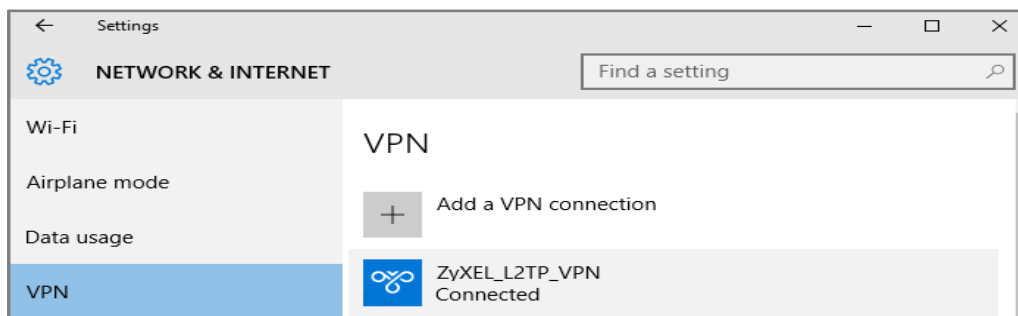

## What Could Go Wrong?

- If you see [alert] log message such as below, please check ZyWALL/USG L2TP Allowed User or User/Group Settings. Android users must use the same Username and Password as configured in ZyWALL/USG to establish the L2TP VPN.

Priority	Category	Message	Note
alert	L2TP Over IPSec	User L2TP_Remote_Users has been denied from L2TP service.(Incorrect Username or Password)	L2TP_LOG

- If you see [info] or [error] log message such as below, please check ZyWALL/USG Phase 1 Settings. Android users must use the same Pre-Shared Key as configured in ZyWALL/USG to establish the IKE SA.

Priority	Category	Message	Note
error	IPSec	SPI: 0x0 (0) SEQ: 0x0 (0) No rule found. Drooping TCP packet	IPSec
info	IKE	Send:[NOTIFY:INVALID_PAYLOAD_TYPE]	IKE_LOG
info	IKE	Invalid payload type in encrypted payload chain, possibly because of different pre-shared keys	IKE_LOG
Priority	Category	Message	Note
info	IKE	[SA] : No proposal chosen	IKE_LOG
info	IKE	[ID] : Tunnel [WIZ_L2TP_VPN] Phase 1 Remote ID mismatch	IKE_LOG

- If you see that Phase 1 IKE SA process has completed but still get [info] log message as below, please check ZyWALL/USG Phase 2 Settings. ZyWALL/USG unit must set correct **Local Policy** to establish the IKE SA.

Priority	Category	Message	Note
info	IKE	[ID] : Tunnel [WIZ_L2TP_VPN] Phase 2 Local policy mismatch	IKE_LOG
Priority	Category	Message	Note
info	IKE	Send:[HASH][NOTIFY:NO_PROPOSAL_CHOSEN]	IKE_LOG
info	IKE	[SA] : No proposal chosen	IKE_LOG
info	IKE	[SA] : Tunnel [WIZ_L2TP_VPN] Phase 2 proposal mismatch	IKE_LOG

- Ensure that the L2TP Address Pool does not conflict with any existing LAN1, LAN2, DMZ, or WLAN zones, even if they are not in use.





- 11** If you cannot access devices in the local network, verify that the devices in the local network set the USG's IP as their default gateway to utilize the L2TP tunnel.
- 12** Make sure the ZyWALL/USG units' security policies allow IPSec VPN traffic. IKE uses UDP port 500, AH uses IP protocol 51, and ESP uses IP protocol 50.
  
- 13** Verify that the Zone is set correctly in the VPN Connection rule. This should be set to IPSec\_VPN Zone so that security policies are applied properly.

## How to Configure the L2TP VPN with Apple MAC OS X 10.11 Operating System

This is an example of using the L2TP VPN and VPN client software included in Apple MAC OS X 10.11 El Capitan operating systems. When the VPN tunnel is configured, users can securely access the network behind the ZyWALL/USG and allow traffic from L2TP clients to go to the Internet from an Apple computer.

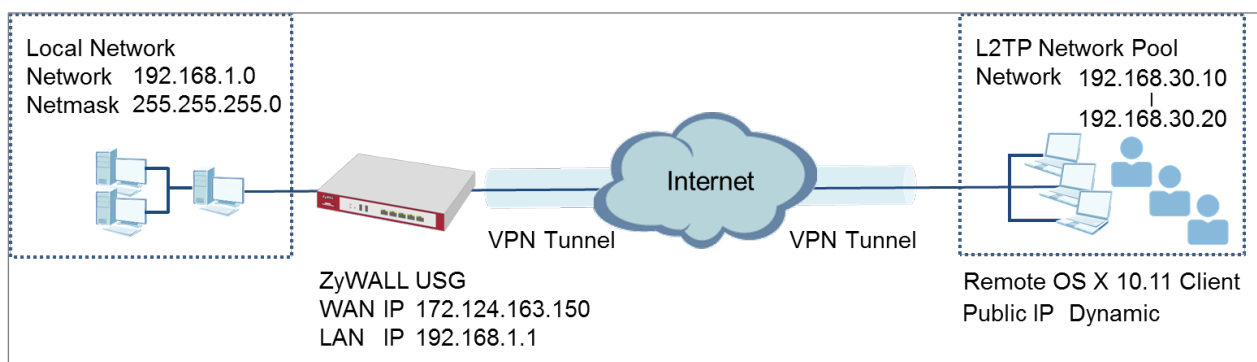
ZyWALL/USG L2TP VPN with Apple MAC OS X 10.11 El Capitan



 Note: All network IP addresses and subnet masks are used as examples in this article. Please replace them with your actual network IP addresses and subnet masks. This example was tested using USG310 (Firmware Version: ZLD 4.25) and Apple MAC (Version: OS X10.11 El Capitan).

## Set Up the L2TP VPN Tunnel on the ZyWALL/USG

In the ZyWALL/USG, go to **Quick Setup > VPN Setup Wizard**, use the **VPN Settings for L2TP VPN Settings** wizard to create a **L2TP VPN** rule that can be used with the MAC OS X clients. Click **Next**.

**Quick Setup > VPN Setup Wizard > Welcome**

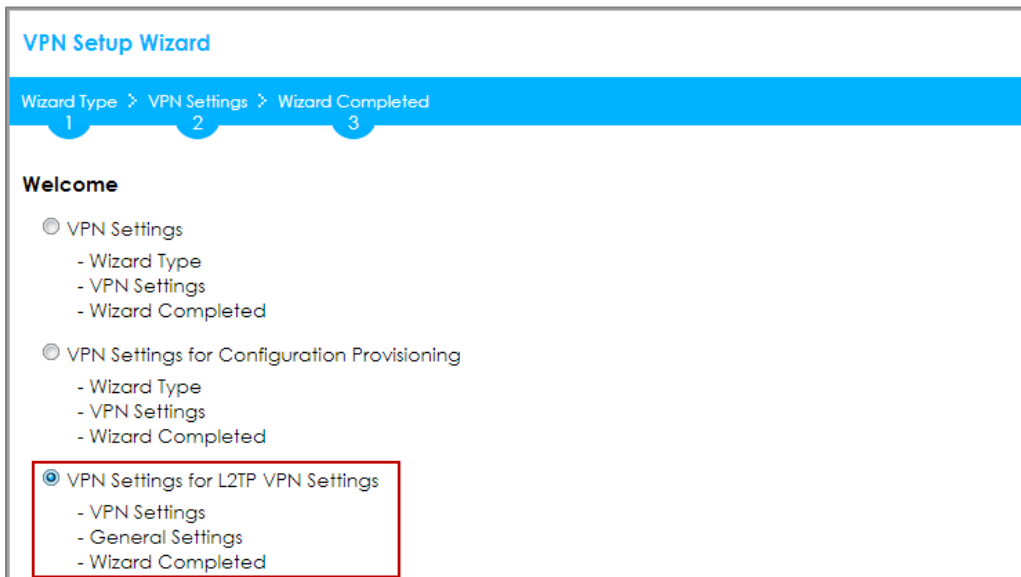

Then, configure the **Rule Name** and set **My Address** to be the **wan1** interface which is connected to the Internet. Type a secure **Pre-Shared Key** (8-32 characters).

**Quick Setup > VPN Setup Wizard > Welcome > VPN Settings**

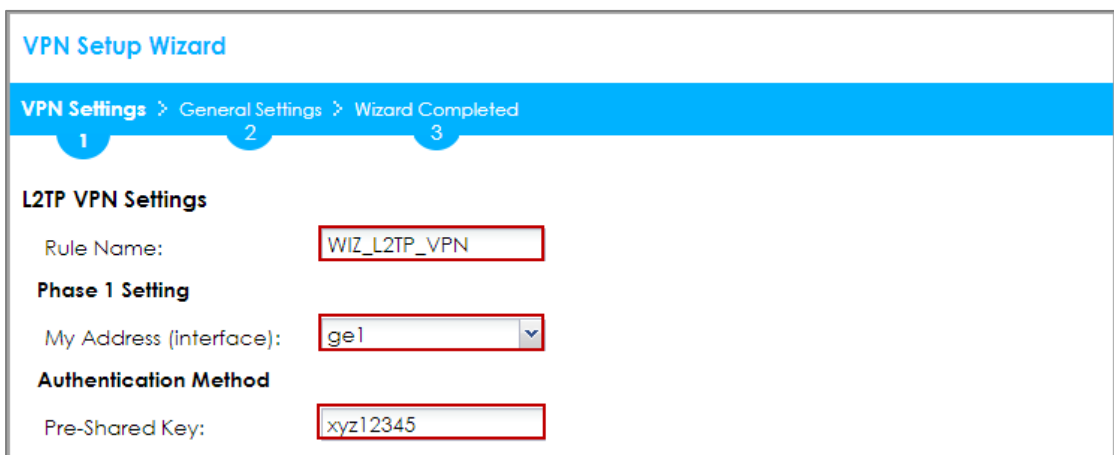

Configure the L2TP users' IP address range from 192.168.30.10 to 192.168.30.20 for use in the L2TP VPN tunnel and check **Allow L2TP traffic Through WAN**. Click **OK**.

**Quick Setup > VPN Setup Wizard > Welcome > VPN Settings**

**VPN Setup Wizard**

VPN Settings > General Settings > Wizard Completed

1      2      3

**L2TP VPN Settings**

IP Address Pool: RANGE i

Starting IP Address: 192.168.30.10

End IP Address: 192.168.30.20

First DNS Server (Optional):

Second DNS Server (Optional):

Allow L2TP traffic Through WAN

Continue to the next page to review your **Summary** and click **Save**.

**Quick Setup > VPN Setup Wizard > Welcome > VPN Settings > Summary**

**VPN Setup Wizard**

Wizard Type > VPN Settings > Wizard Completed

1      2      3

**Express Settings**

**Summary**

Rule Name: WIZ\_L2TP\_VPN

Secure Gateway: Any

Pre-Shared Key: xyz12345

My Address (interface): ge1

IP Address Pool: RANGE, 192.168.30.10 - 192.168.30.20

**Quick Setup > VPN Setup Wizard > Welcome > VPN Settings > Summary > Wizard Completed**

**VPN Setup Wizard**

Wizard Type > VPN Settings > **Wizard Completed**

1      2      **3**

**L2TP VPN Settings**

Congratulations. The VPN Access wizard is completed

Summary

Rule Name:	WIZ_L2TP_VPN2
My Address (interface):	ge1
Pre-Shared Key:	xyz12345
IP Address Pool:	RANGE, 192.168.30.10 - 192.168.30.20

Go to **CONFIGURATION > VPN > L2TP VPN > Create new Object > User** to add **User Name** and **Password** (4-24 characters). Then, set **Allowed User** to the newly created object (L2TP\_Remote\_Users/zyx168 in this example).

**CONFIGURATION > VPN > L2TP VPN > Create new Object > User**

**L2TP VPN**

Show Advanced Settings Create new Object ▼

**General Settings** Config Walkth Address reshooting

Enable L2TP Over IPSec

VPN Connection: WIZ\_L2TP\_VPN ▼

IP Address Pool: WIZ\_L2TP\_VPN\_IP\_A ▼ RANGE, 192.168.30.10-192.168.30.20 ⓘ

Authentication Method: default ▼ local

Advance

Allowed User: any ▼

Keep Alive Timer: 60 (1-180 seconds)

**+ Add A User** ⓘ

**User Configuration**

User Name : L2TP\_Remote\_Users

User Type: user ▼

Password: .....

Retype: .....

Description: Local User

Authentication Timeout Settings  Use Default Settings  Use Manual Settings

Lease Time: 1440 minutes

Reauthentication Time: 1440 minutes

**OK** **Cancel**

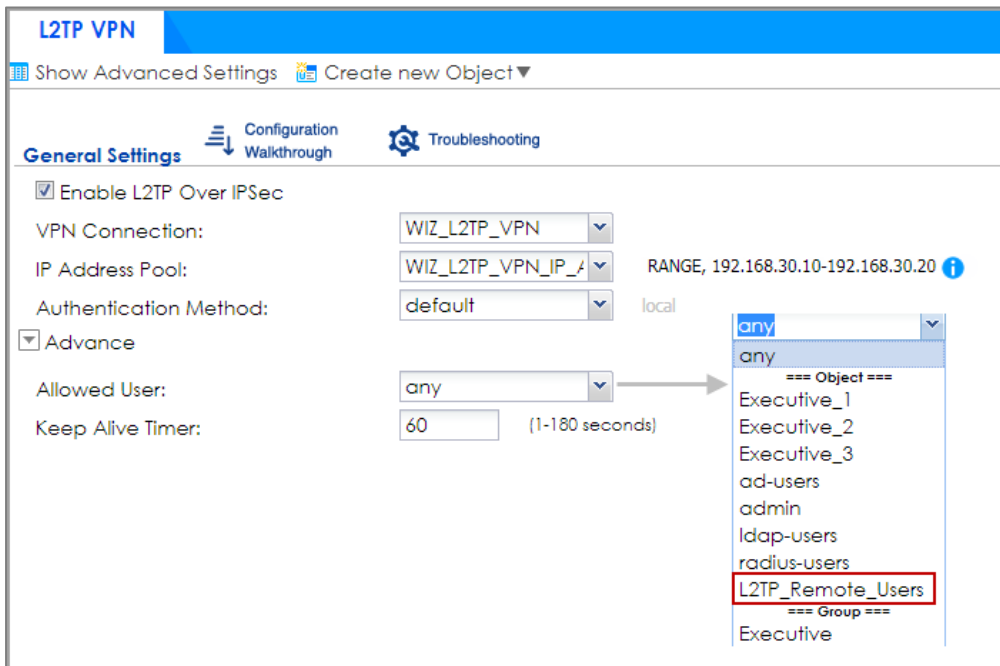

## Set Up the L2TP VPN Tunnel on the Apple MAC OS X 10.11 El Capitan Operating System

To configure L2TP VPN in OS X 10.11 operation system, go to **System Preferences...** > **Network**, click the "+" button at the bottom left of the connections to add a new connection and configure as follows.

Set the **Interface** to be **VPN**, select **VPN Type** to be **L2TP over IPsec**.

Configure **Service Name** for you to identify the VPN configuration. Click **Create**.

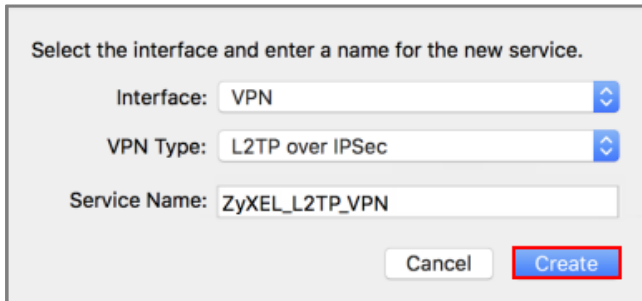

Select the interface and enter a name for the new service.

Interface: VPN

VPN Type: L2TP over IPSec

Service Name: ZyXEL\_L2TP\_VPN

Cancel Create

Configure **Server Address** to be the ZyWALL/USG's WAN IP address (172.124.163.150 in this example). Enter **Account Name** which should be the same as **Allowed User** created in ZyWALL/USG (L2TP\_Remote\_Users in this example).

Then, click **Authentication Settings...**

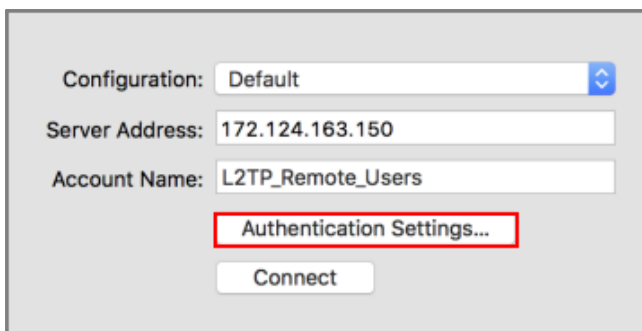

Configuration: Default

Server Address: 172.124.163.150

Account Name: L2TP\_Remote\_Users

Authentication Settings...

Connect

In the **User Authentication** section, enter **Password** which should be the same as **Allowed User** created in ZyWALL/USG (zyx123 in this example).

In the **Machine Authentication** section, enter **Shared Secret** to be the pre-shared key of the IPSec VPN gateway the ZyWALL/USG uses for L2TP VPN over IPSec (zyx12345 in this example). Click **OK**.



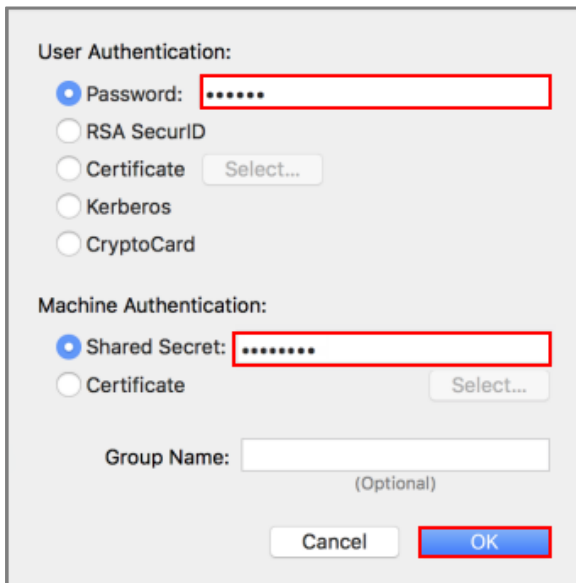

User Authentication:

- Password: [.....]
- RSA SecurID
- Certificate [Select...]
- Kerberos
- CryptoCard

Machine Authentication:

- Shared Secret: [.....]
- Certificate [Select...]

Group Name: [ ]  
(Optional)

[Cancel] [OK]

Go back to **Configuration** and click **Advanced....** Select **Send all traffic over VPN connection** to allow the L2TP/IPSec VPN traffic between ZyWALL/USG and MAC OS X system.

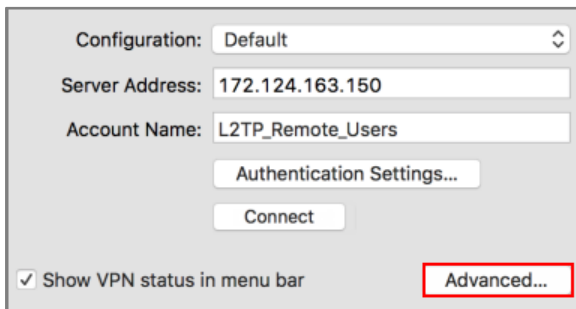

Configuration: [Default]

Server Address: [172.124.163.150]

Account Name: [L2TP\_Remote\_Users]

[Authentication Settings...]

[Connect]

Show VPN status in menu bar [Advanced...]

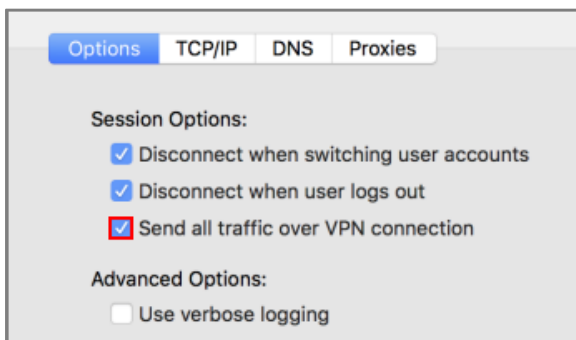

Options TCP/IP DNS Proxies

Session Options:

- Disconnect when switching user accounts
- Disconnect when user logs out
- Send all traffic over VPN connection

Advanced Options:

- Use verbose logging

Go back to **Configuration** and click **Connect**.

Configuration:

Server Address:

Account Name:

## Test the L2TP over IPSec VPN Tunnel

Go to ZyWALL/USG **CONFIGURATION** > **VPN** > **IPSec VPN** > **VPN Connection**, the **Status** connect icon is lit when the interface is connected.

### CONFIGURATION > VPN > IPSec VPN > VPN Connection

#	Status	Name	VPN Gateway	Policy
1		VPN_to_VPC	VPN_to_VPC	<a href="#">VPN_to_VPC_LOCAL/VPN_to_V...</a>
2		VPN_to_Azure	VPN_to_Azure	<a href="#">VPN_to_Azure_LOCAL/VPN_to_...</a>
3		Hub_HQ_to_Branch_A	Hub_HQ_to_Branch_A	<a href="#">VPN_to_VPC_LOCAL/Spoke_Bra...</a>
4		Hub_HQ_to_Branch_B	Hub_HQ_to_Branch_B	<a href="#">Hub_HQ/Spoke_Branch_B_LOCAL</a>
5		Spoke_Branch_A	Spoke_Branch_A	<a href="#">Spoke_Branch_A_LOCAL/Hub_HQ</a>
6		Spoke_Branch_B	Spoke_Branch_B	<a href="#">Spoke_Branch_B_LOCAL/Hub_HQ</a>
7		WIZ_VPN_Branch	WIZ_VPN_Branch	<a href="#">WIZ_VPN_Branch_LOCAL/WIZ_V...</a>
8		WIZ_L2TP_VPN	WIZ_L2TP_VPN	<a href="#">WIZ_L2TP_VPN_LOCAL/</a>

Go to ZyWALL/USG **MONITOR** > **VPN Monitor** > **IPSec** and verify the tunnel **Up Time** and the **Inbound(Bytes)/Outbound(Bytes)** traffic. Click **Connectivity Check** to verify the result of ICMP Connectivity.

### MONITOR > VPN Monitor > IPSec > WIZ\_L2TP\_VPN

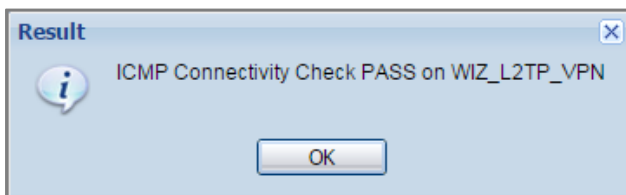
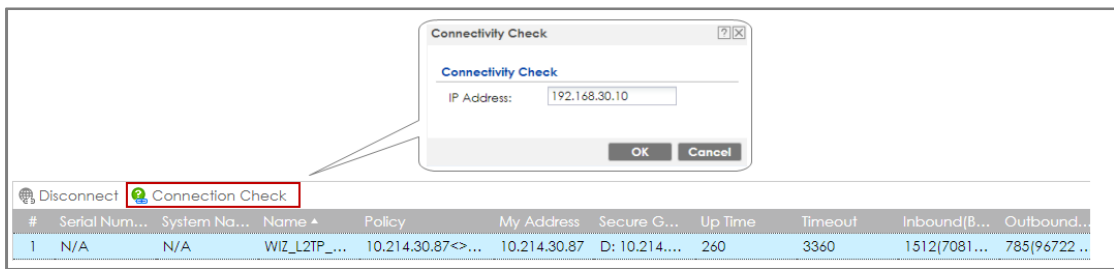

功能有問題無法截圖, connectivity check fail

Go to ZyWALL/USG **MONITOR > VPN Monitor > L2TP over IPSec** and verify the **Current L2TP Session**.

**MONITOR > VPN Monitor > L2TP over IPSec > L2TP\_Remote\_Users**

The screenshot shows the 'Current L2TP Session' table with 'Disconnect' and 'Refresh' buttons. The table contains one session:

#	User Name	Hostname	Assigned IP	Public IP
1	L2TP_Remote_Users	Apple_MAC_OS_X	192.168.30.10	36.226.103.25

Go to MAC OS X **System Preferences... > Network** and show **Connected** status, **Connect Time** and assigned **IP Address**.

**System Preferences... > Network**

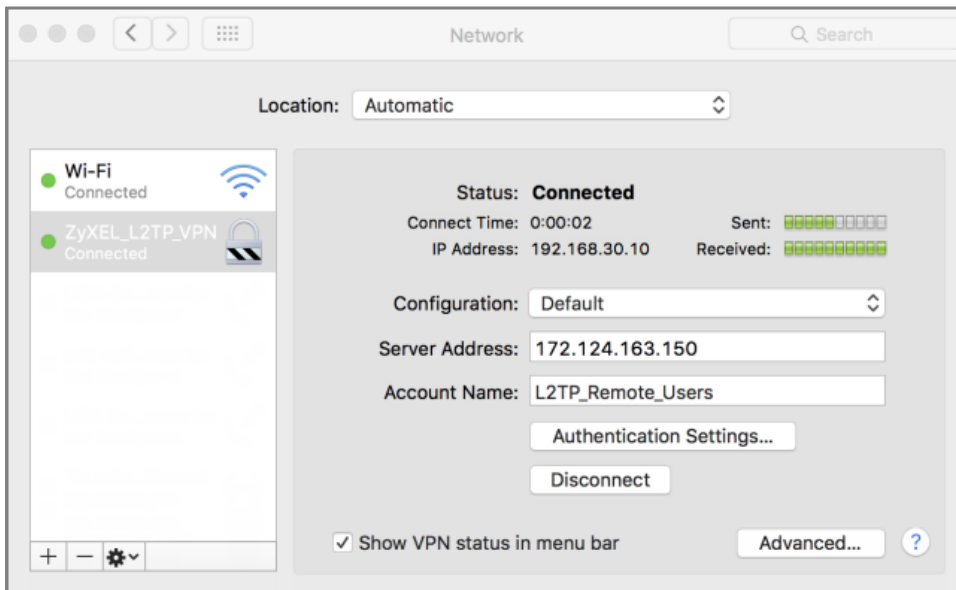

## What Could Go Wrong?

If you see [alert] log message such as below, please check ZyWALL/USG L2TP **Allowed User** or **User/Group Settings**. Apple MAC OS X El Capitan operating system users must use the same **Username** and **Password** as configured in ZyWALL/USG to establish the L2TP VPN.

#	Time	Priority	Category	Message	Note
6	2017-06-...	alert	L2TP Over IPS...	User L2TP_Remote_Users has been denied from L2TP service.(Incorrect Username or Password)	L2TP_LOG

If you see [info] or [error] log message such as below, please check ZyWALL/USG Phase 1 Settings. Apple MAC OS X El Capitan operating system users must use the same **Pre-Shared Key** as configured in ZyWALL/USG to establish the IKE SA.

Priority	Category	Message	Note
info	IKE	Send:[NOTIFY:INVALID_PAYLOAD_TYPE]	IKE_LOG
info	IKE	Invalid payload type in encrypted payload chain, possibly because of different pre-shared keys	IKE_LOG
Priority	Category	Message	Note
info	IKE	[SA] : No proposal chosen	IKE_LOG
info	IKE	[ID] : Tunnel [WIZ_L2TP_VPN] Phase 1 Peer ID mismatch	IKE_LOG

If you see that Phase 1 IKE SA process has completed but still get [info] log message as below, please check ZyWALL/USG Phase 2 Settings. ZyWALL/USG unit must set correct **Local Policy** to establish the IKE SA.

Priority	Category	Message	Note
info	IKE	Send:[HASH][NOTIFY:NO_PROPOSAL_CHOSEN]	IKE_LOG
info	IKE	[SA] : No proposal chosen	IKE_LOG
info	IKE	[ID] : Tunnel [WIZ_L2TP_VPN] Phase 2 Local policy mismatch	IKE_LOG
info	IKE	Recv:[HASH][SA][NONCE][ID][ID]	IKE_LOG
info	IKE	Phase 1 IKE SA process done	IKE_LOG

Priority	Category	Message	Note
info	IKE	Send:[HASH][NOTIFY:NO_PROPOSAL_CHOSEN]	IKE_LOG
info	IKE	[SA] : No proposal chosen	IKE_LOG
info	IKE	[SA] : Tunnel [WIZ_L2TP_VPN] Phase 2 proposal mismatch	IKE_LOG
info	IKE	Recv:[HASH][SA][NONCE][ID][ID]	IKE_LOG
info	IKE	Phase 1 IKE SA process done	IKE_LOG

Ensure that the L2TP Address Pool does not conflict with any existing LAN1, LAN2, DMZ, or WLAN zones, even if they are not in use.

If you cannot access devices in the local network, verify that the devices in the local network set the USG's IP as their default gateway to utilize the L2TP tunnel.

Make sure the ZyWALL/USG units' security policies allow IPSec VPN traffic. IKE uses UDP port 500, AH uses IP protocol 51, and ESP uses IP protocol 50.

Verify that the Zone is set correctly in the Zone object. This should be set to IPSec\_VPN Zone so that security policies are applied properly.

## How to configure if I want user can only see SSL VPN Login button in web portal login page

This example shows how to restrict portal access for SSL VPN clients. The example instructs how to allow end users to only see the SSL VPN Login button in the web portal login screen and the administrator can only manage the device from LAN.

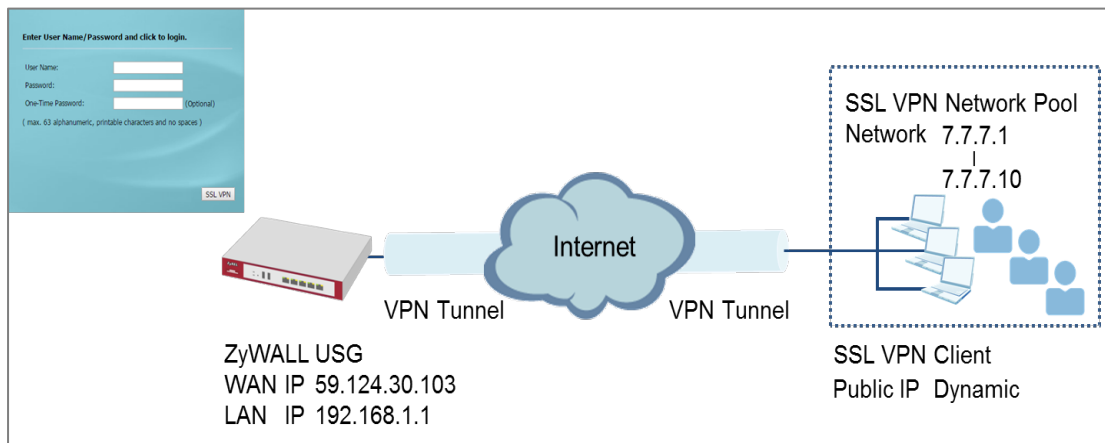

### ZyWALL/USG only see SSL VPN Login button in web portal login page

#### Note:

All network IP addresses and subnet masks are used as examples in this article. Please replace them with your actual network IP addresses and subnet masks. This example was tested using USG60 (Firmware Version: ZLD 4.25).

## Set Up the DNS Service

In this scenario, you need to have a DNS host to fulfill the requirement. In this example, go to <https://www.noip.com/> to register an account and create a DNS host. The following mapping IP address is the public IP of the ZyWALL/USG's WAN IP address.

## Set Up the ZyWALL/USG SSL VPN Setting

In the ZyWALL/USG, go to **CONFIGURATION > VPN > SSL VPN > Global Setting > SSL VPN Login Domain Name** and type in the DNS domain name.

### CONFIGURATION > VPN > SSL VPN > Global Setting > SSL VPN Login Domain Name

Global Settings		
Network Extension Local IP:	<input type="text" value="192.168.200.1"/>	
SSL VPN Login Domain Name		
SSL VPN Login Domain Name 1	<input type="text" value="zyxeltestssl.ddns.net"/>	(Optional)
SSL VPN Login Domain Name 2	<input type="text"/>	(Optional)
Message		
Login Message:	<input type="text" value="Welcome to SSL VPN"/>	
Logout Message:	<input type="text" value="Goodbye to SSL VPN"/>	

Use SSL VPN, you need to allow users to access the **HTTPS** service. Go to **CONFIGURATION > Security Policy > Policy Control**. Make sure the security policy allows **HTTPS** traffic from the **WAN** interface to the **ZyWALL** (the example shows the default settings).

### CONFIGURATION > Security Policy > Policy Control

**General Settings**

Enable Policy Control

**IPv4 Configuration**

Allow Asymmetrical Route

Pri...	St...	Name	From	To	IPv4 Sour...	IPv4 Des...	Service	User	Schedule	A...	Log	UTM Profile
1		LAN1_Outgoing	LAN1	any (Exc...	any	any	any	any	none	all...	no	
2		LAN2_Outgoing	LAN2	any (Exc...	any	any	any	any	none	all...	no	
3		DMZ_to_WAN	DMZ	any (Exc...	any	any	any	any	none	all...	no	
4		IPSec_VPN_Ou...	IPSec_...	any (Exc...	any	any	any	any	none	all...	no	
5		SSL_VPN_Outg...	SSL_VPN	any (Exc...	any	any	any	any	none	all...	no	
6		TUNNEL_Outg...	TUNNEL	any (Exc...	any	any	any	any	none	all...	no	
7		LAN1_to_Device	LAN1	ZyWALL	any	any	any	any	none	all...	no	
8		LAN2_to_Device	LAN2	ZyWALL	any	any	any	any	none	all...	no	
9		DMZ_to_Device	DMZ	ZyWALL	any	any	Default	any	none	all...	no	
10		WAN_to_Device	WAN	ZyWALL	any	any	Default	any	none	all...	no	
11		IPSec_VPN_to_...	IPSec_...	ZyWALL	any	any	any	any	none	all...	no	

**Default-Allow-WAN-To-ZyWALL**  
 Description: System Default Allow From WAN To ZyWALL  
 Members: AH, ESP, **HTTPS**, IKE, NAT, GRE, VRRP

## Set Up the ZyWALL/USG System Setting

Go to **CONFIGURATION > System > WWW > Admin Service Control > Add Admin ACL Rule 1**. Set the address access action as **Deny** for **ALL** address in **WAN**.

**CONFIGURATION > System > WWW > Admin Service Control > Add Admin ACL Rule 1**

**[HTTPS] Add Admin ACL Rule1**

Create new Object ▾

Address Object:

Zone:

Action:

**HTTPS**

Enable

Server Port:

Authenticate Client Certificates (See [Trusted CAs](#))

Server Certificate:

Redirect HTTP to HTTPS

**Admin Service Control**

#	Zone	Address	Action
1	WAN	ALL	deny
-	ALL	ALL	accept

Displaying 1 - 2 of 2



## Test the SSL VPN

Type in the URL (<https://sslvpnzyxelttest.ddns.net>) and you will only see the **SSL VPN Login** button in the web portal screen.

Type in the URL (<https://sslvpnzyxelttest.ddns.net>)

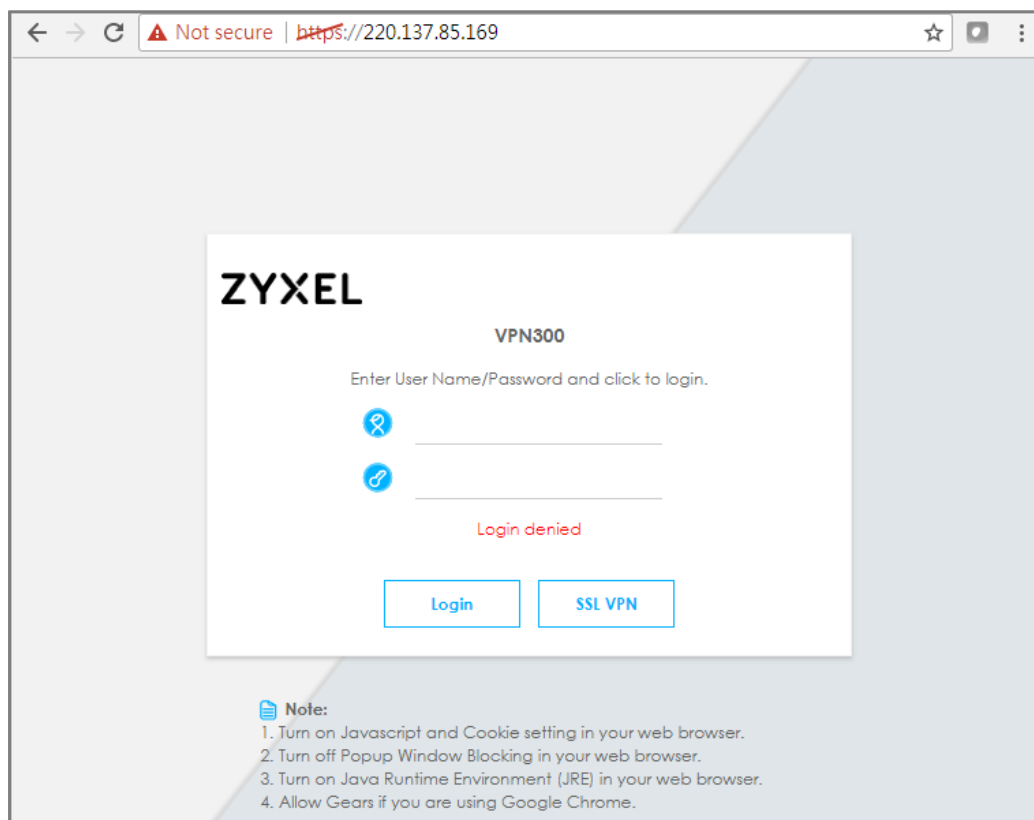

Login to the device via the WAN interface with the administrator's user name and password. The screen will show **Login denied**.

## Login to the device via the WAN interface

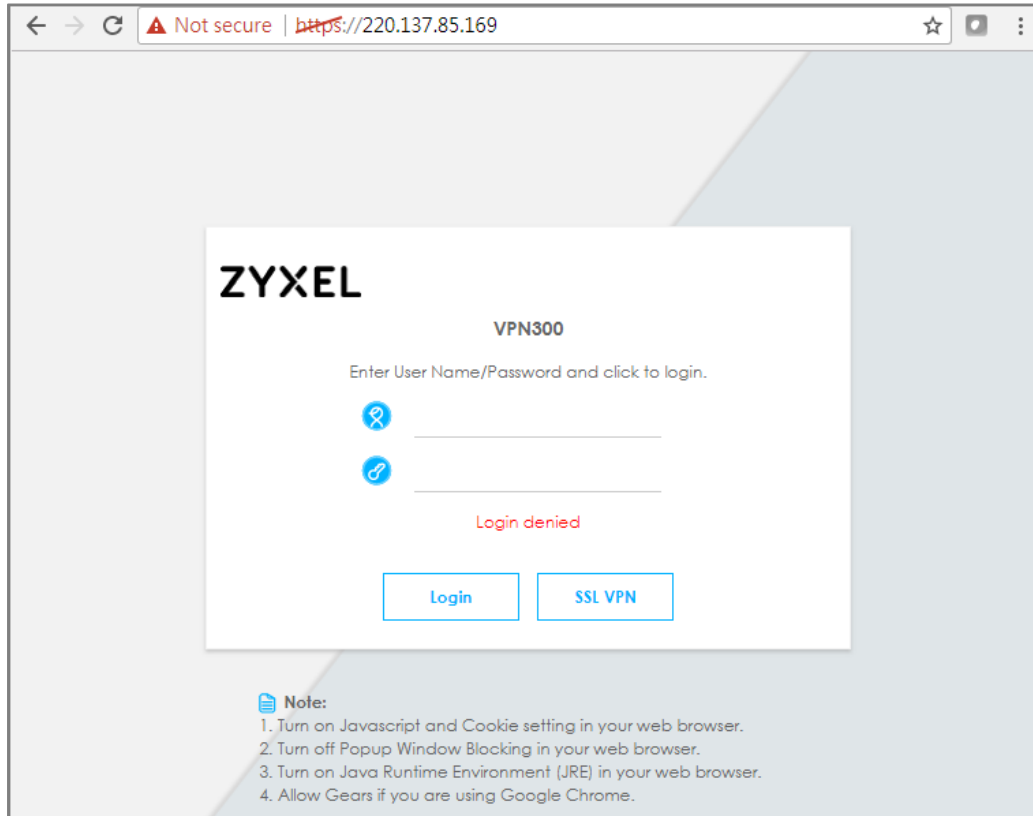

Login to the device via the LAN interface with the administrator's user name and password. The management portal will be displayed.

## Login to the device via the LAN interface

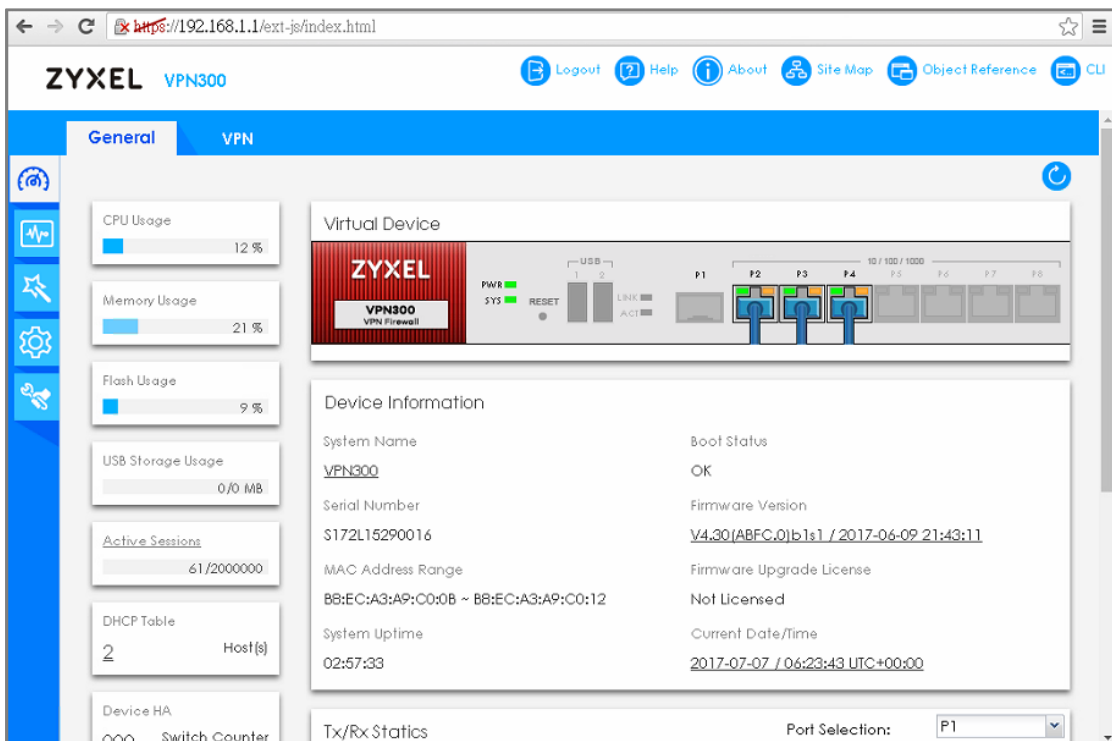
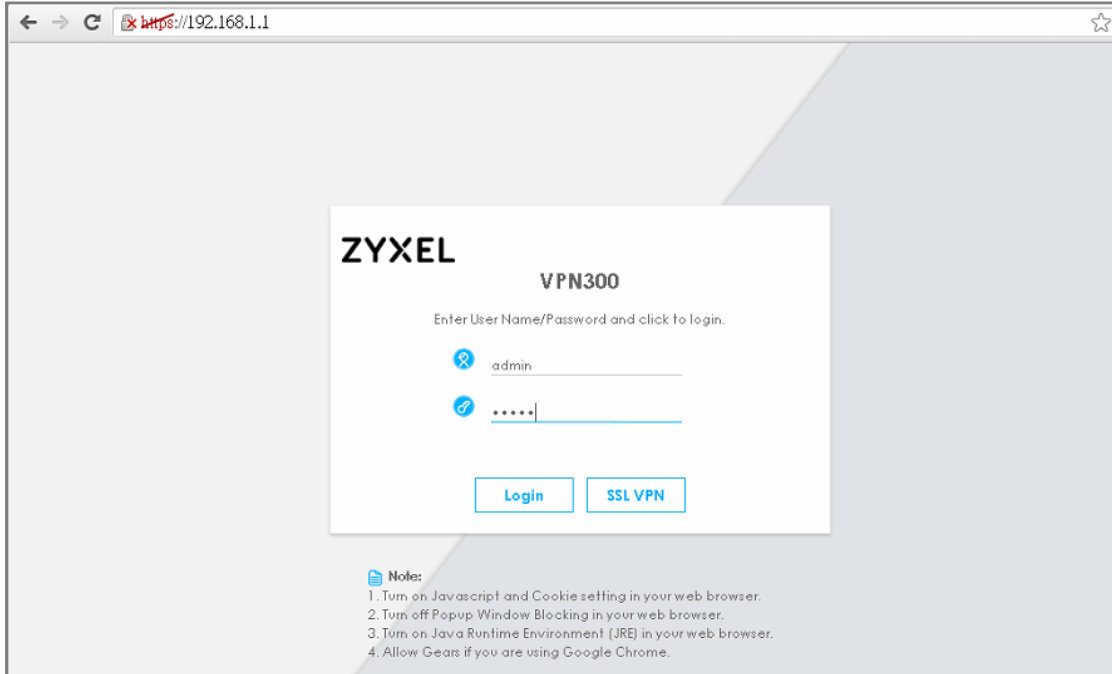

Go to **MONITOR > Log**. You can see that the admin login has been denied access from the WAN interface but it is allowed from the LAN interface.

## MONITOR > Log

Logs						
Category: <input type="text" value="User"/>						
Email Log Now Refresh Clear Log						
Priority	C...	Message	Source	Destination	Note	
notice	User	Administrator admin(MAC=00:16:36:2B:B4:2F) from http/https has logged out Device	192.168.1.34	192.168.1.1	Account: admin	
notice	User	Administrator admin(MAC=00:16:36:2B:B4:2F) from http/https has logged in Device	192.168.1.34	192.168.1.1	Account: admin	
notice	User	User admin has been denied access from HTTPS	10.214.30.55:5...	10.214.30.90:443	Account: admin	

## How to Deploy SSL VPN with Apple Mac OS X 10.10 Operating System

This is an example of using the ZyWALL/USG SSL VPN client software in Apple MAC OS X 10.10 Yosemite operating systems for secure connections to the network behind the ZyWALL/USG. When the VPN tunnel is configured, users can securely access the network from a Mac OS X 10.11 Yosemite computer.

ZyWALL/USG SSL VPN with Apple MAC OS X 10.10 Yosemite

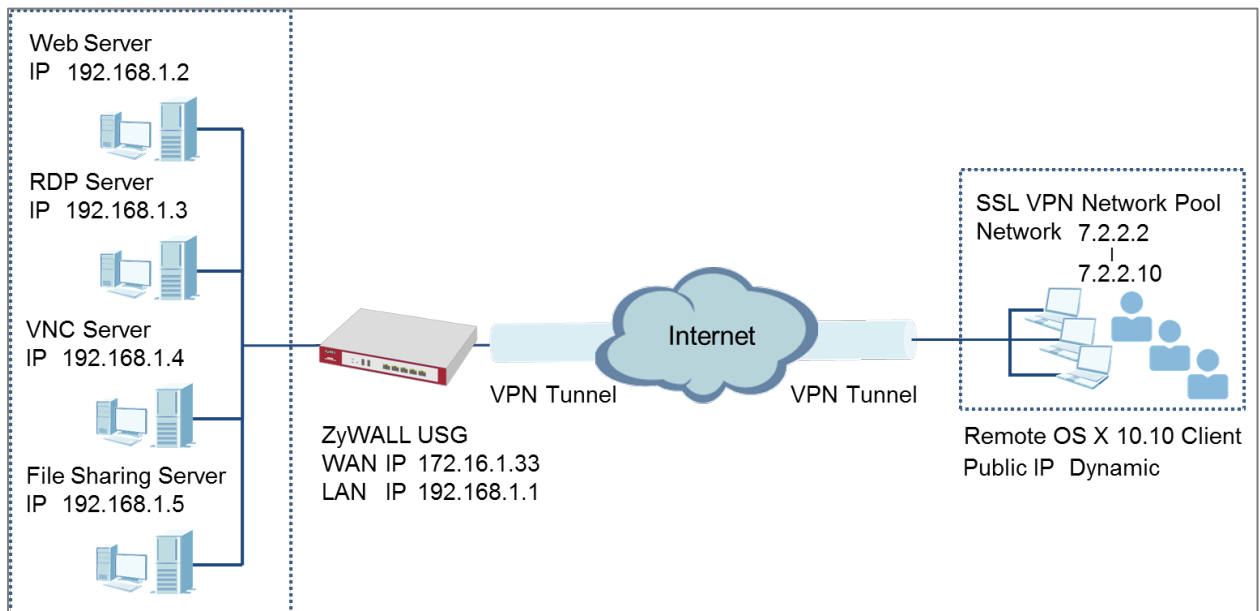

 **Note:** All network IP addresses and subnet masks are used as examples in this article. Please replace them with your actual network IP addresses and subnet masks. This example was tested using USG110 (Firmware Version: ZLD 4.25) and Apple MAC (Version: OS X10.10 Yosemite).

## Set Up the SSL VPN Tunnel on the ZyWALL/USG

In the ZyWALL/USG, go to **CONFIGURATION > VPN > SSL VPN > Access Privilege** to add an **Access Policy**. Configure a **Name** for you to identify the SSL VPN configuration.

**CONFIGURATION > VPN > SSL VPN > Access Privilege > Access Policy > Configuration**

**Configuration**

Enable Policy

Name:

Zone:  ⓘ

Description:  (Optional)

Go to **Create new Object > User** to add **User Name** (SSL\_VPN\_1\_Users in this example) and **Password** (4-24 characters, zyx168 in this example), click **OK**.

**CONFIGURATION > VPN > SSL VPN > Access Privilege > Access Policy > Create new Object > User**

**+ Add Access Policy**

Create new Object ▾

User

Application

Address

Name:

Zone:  ⓘ

Description:  (Optional)

---

**+ Add A User**

**User Configuration**

User Name :

User Type:

Password:

Retype:

Description:

OK Cancel

Go to **Create new Object > Application** to add servers you allow **SSL\_VPN\_1\_Users** to access, click **OK**.

**CONFIGURATION > VPN > SSL VPN > Access Privilege > Access Policy > Create new Object > Application**

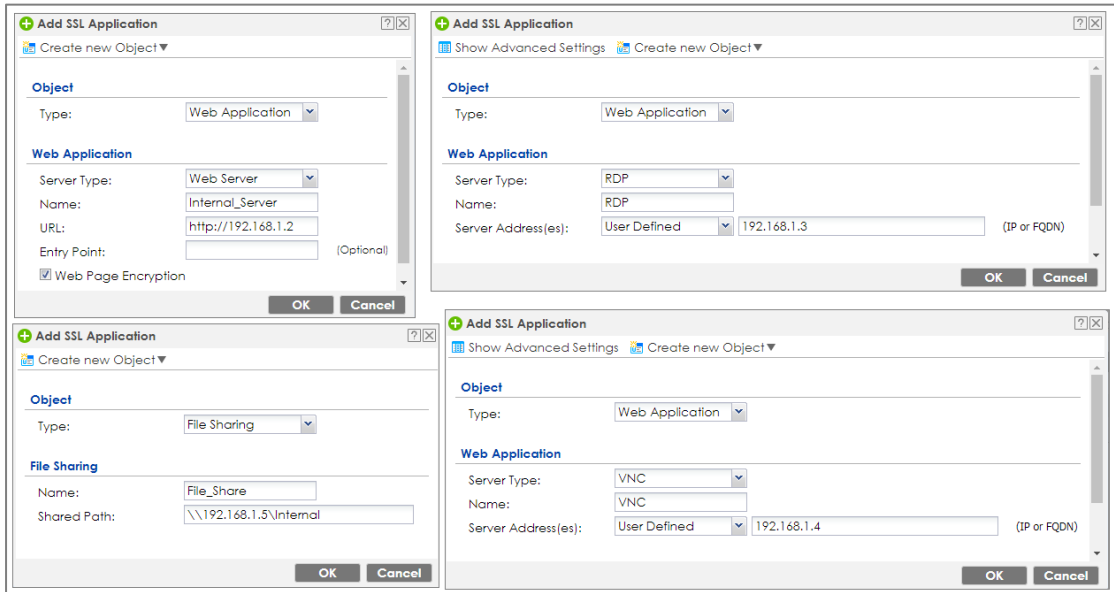

Go to **Create new Object > Address** to add the IP address pool for **SSL\_VPN\_1\_Users**.

**CONFIGURATION > VPN > SSL VPN > Access Privilege > Access Policy > Create new Object > Address**

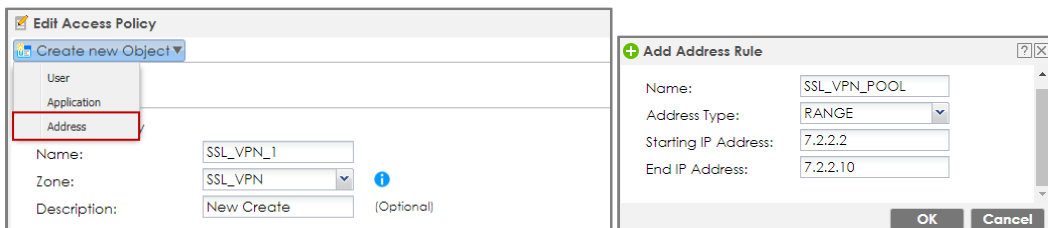

Then, move the just created address object to **Selected User/Group Objects**.

Similarly, in **SSL Application List (Optional)** move the servers you want available to SSL users to **Selected Appellation Objects**.

**CONFIGURATION > VPN > SSL VPN > Access Privilege > Access Policy > User/Group & SSL Application**

**User/Group**

<p style="background-color: #f0f0f0; margin: 0; padding: 2px;">Selectable User/Group Objects</p> <ul style="list-style-type: none"> <li>billing-users</li> <li>ua-users</li> <li>trial-users</li> <li>L2TP_Remote_Users</li> <li style="border: 2px solid red;">SSL_VPN_1_Users</li> </ul>	<div style="border: 1px solid red; width: 20px; height: 20px; margin: 5px auto; display: flex; align-items: center; justify-content: center;">➔</div> <div style="border: 1px solid blue; width: 20px; height: 20px; margin: 5px auto; display: flex; align-items: center; justify-content: center;">➕</div>	<p style="background-color: #f0f0f0; margin: 0; padding: 2px;">Selected User/Group Objects</p> <div style="border: 1px solid gray; height: 80px;"></div>
--	--	--

**SSL Application List (Optional)**

<p style="background-color: #f0f0f0; margin: 0; padding: 2px;">Selectable Application Objects</p> <ul style="list-style-type: none"> <li style="border: 2px solid red;">Internal_Server</li> <li>RDP</li> <li>VNC</li> <li>File_Share</li> </ul>	<div style="border: 1px solid red; width: 20px; height: 20px; margin: 5px auto; display: flex; align-items: center; justify-content: center;">➔</div> <div style="border: 1px solid blue; width: 20px; height: 20px; margin: 5px auto; display: flex; align-items: center; justify-content: center;">➕</div>	<p style="background-color: #f0f0f0; margin: 0; padding: 2px;">Selected Application Objects</p> <div style="border: 1px solid gray; height: 80px;"></div>
--	--	---

Scroll down to **Network Extension (Optional)** to select **Enable Network Extension** to allow SSL VPN users to access the resources behind the ZyWALL/USG local network.

Select network(s) name in the **Selectable Address Objects** list and click the right arrow button to add to the **Selected Address Objects** list. You can select more than one network.

**CONFIGURATION > VPN > SSL VPN > Access Privilege > Access Policy > Network Extension (Optional)**



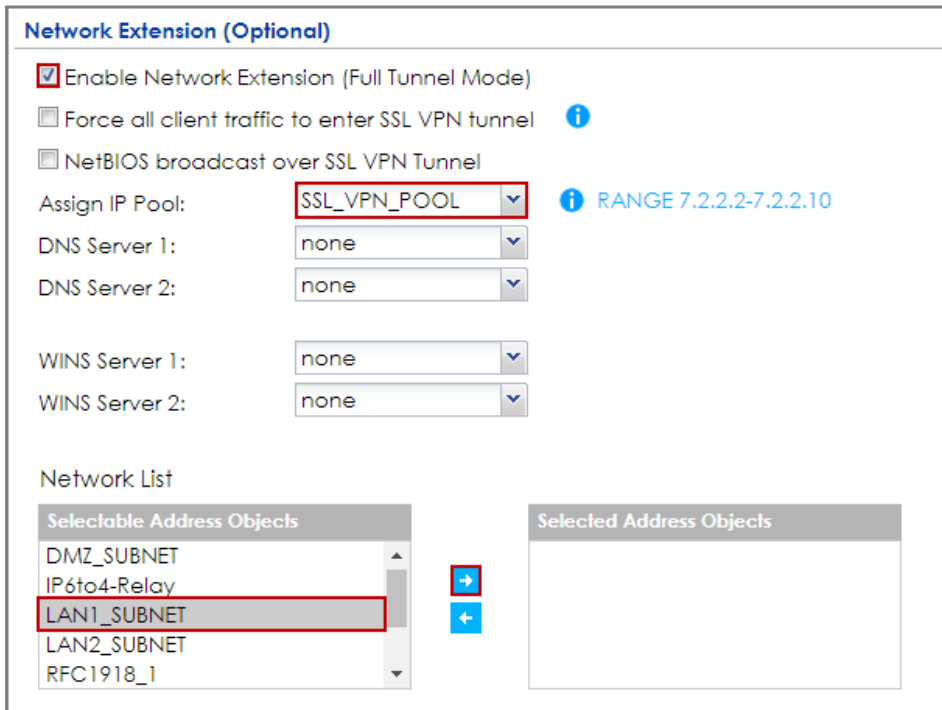

## Set Up the SSL VPN Tunnel on the Apple MAC OS X 10.10 Operating System

Download SSL VPN Client software: **ZyWALL SecuExtender** for MAC from the ZyXEL Global Website and double-click on the downloaded file to install it.

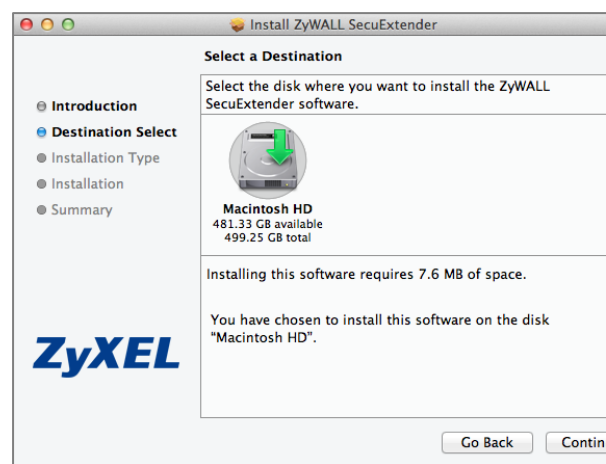
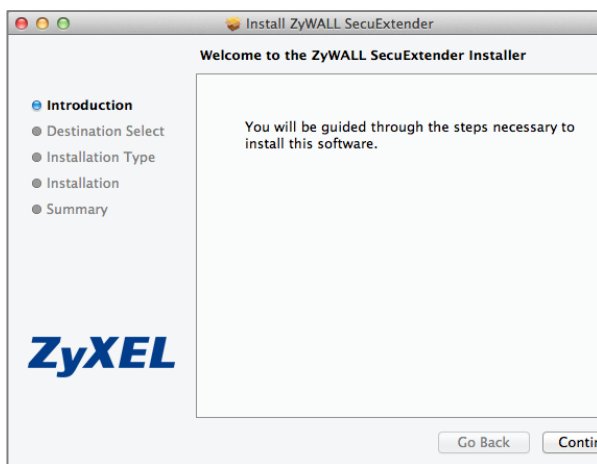

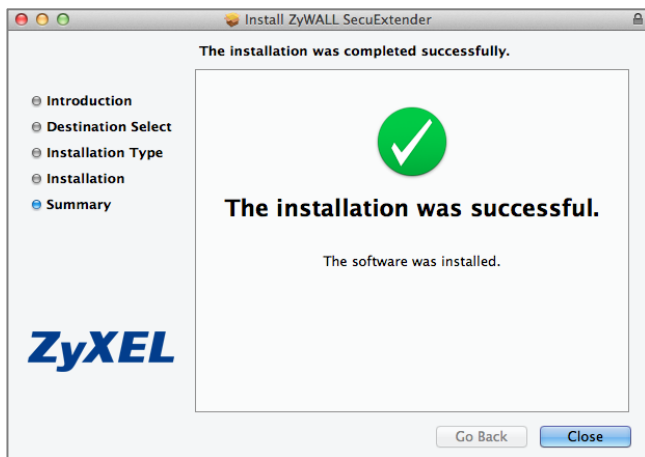
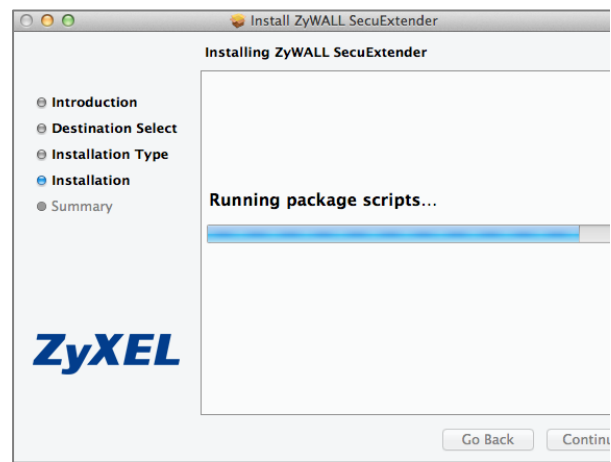
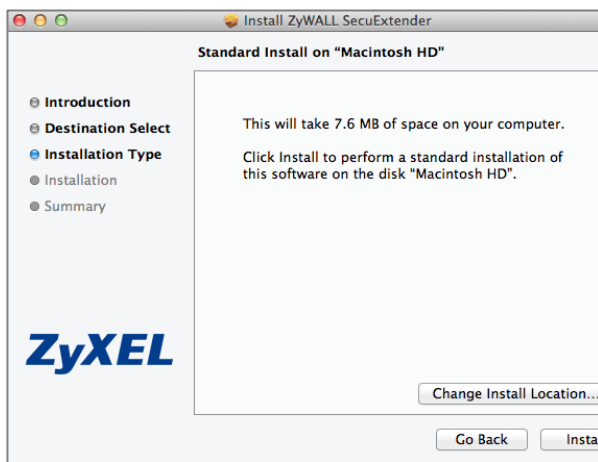

Go to **ZyWALL SecuExtender > Preferences**, click the "+" button at the bottom left to add a new SSL VPN connection.



Configure the **Connection Name** for you to identify the SSL VPN configuration.  
Then, set the **Remote Server Address** to be the WAN IP of ZyWALL/USG (172.16.1.33 in this example). Click **Save**.



Here are two methods to initiate SSL VPN connections:

From ZyWALL SecuExtender

From a Web Browser

## From ZyWALL SecuExtender

Go to **ZyWALL SecuExtender > Connect > SSL\_VPN**, to display the username and password dialog box. Set **Username** and **Password** to be the same as your ZyWALL/USG SSL VPN **Selected User/Group** name and password (SSL\_VPN\_1\_Users/zyx168 in this example).

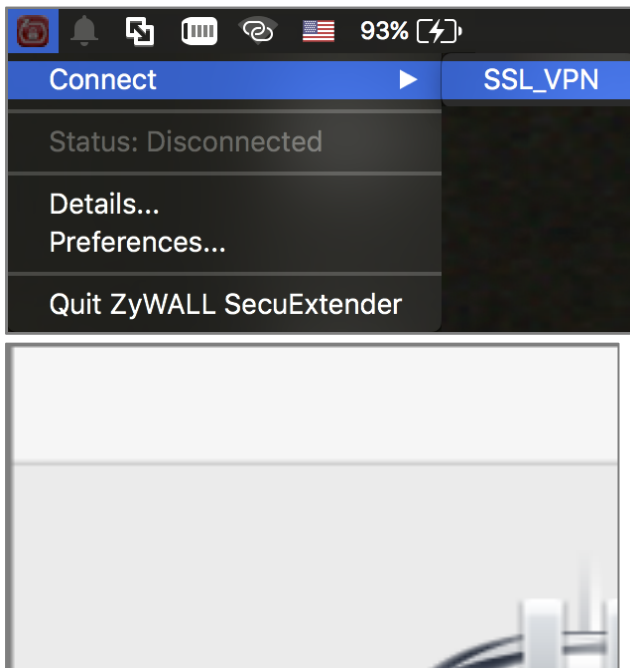

## From a Web Browser

Type ZyWALL/USG's WAN IP into the browser, to display the login screen. Enter **User Name** and **Password** to be the same as your ZyWALL/USG SSL VPN **Selected User/Group** name and password (SSL\_VPN\_1\_Users/zyx168 in this example). Click **SSL VPN**.

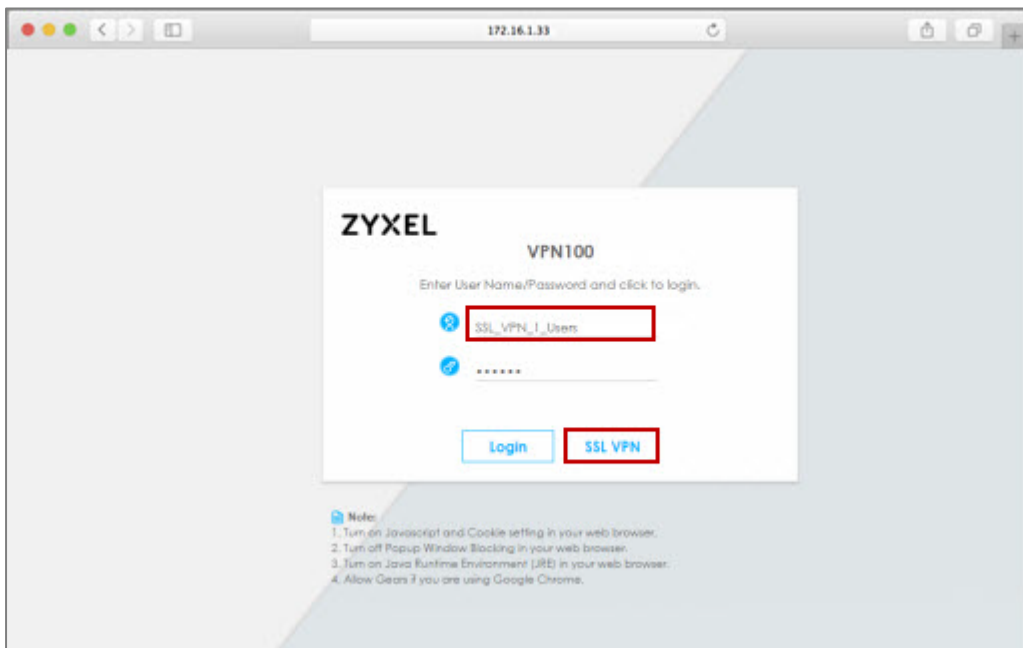

## Test the SSL VPN Tunnel

Go to ZyWALL/USG **MONITOR** > **VPN Monitor** > **SSL** and verify the tunnel **Login Address**, **Connected Time** and the **Inbound(Bytes)/Outbound(Bytes)** traffic.

**MONITOR** > **VPN Monitor** > **SSL** > **SSL\_VPN\_1\_Users**

Current SSL VPN Connection						
#	User	Access	Login Address	Connected Time	Inbound(Bytes)	Outbound(Bytes)
1	SSL_VPN_1_Users	Network-Extension	10.214.30.104	00:01:39	9390	503

Go to **ZyWALL SecuExtender** > **Details** and check **Traffic Graph**, **Network Traffic Statics** and **Log Details**.

## ZyWALL SecuExtender > Details > Traffic Graph

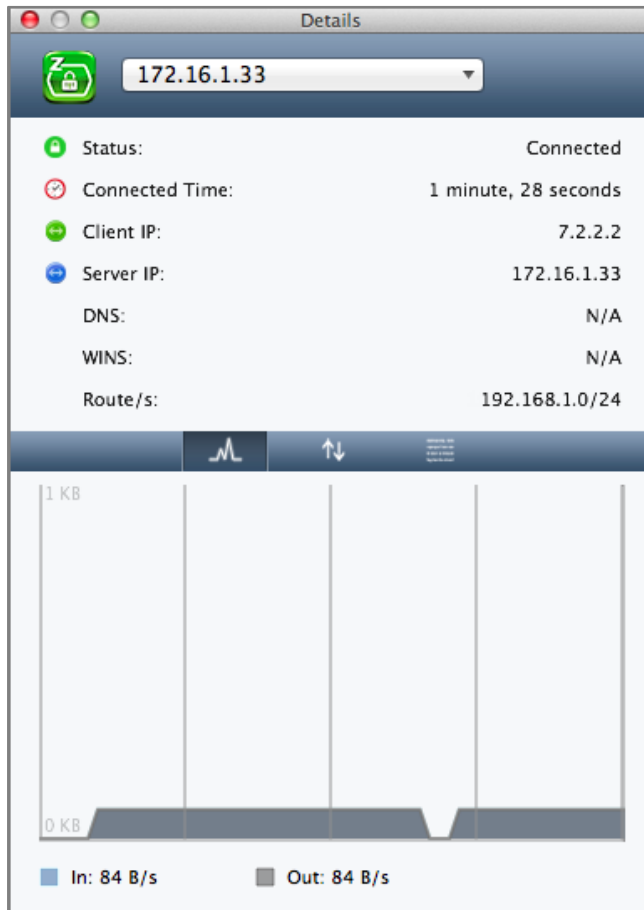

## ZyWALL SecuExtender > Details > Network Traffic Statics

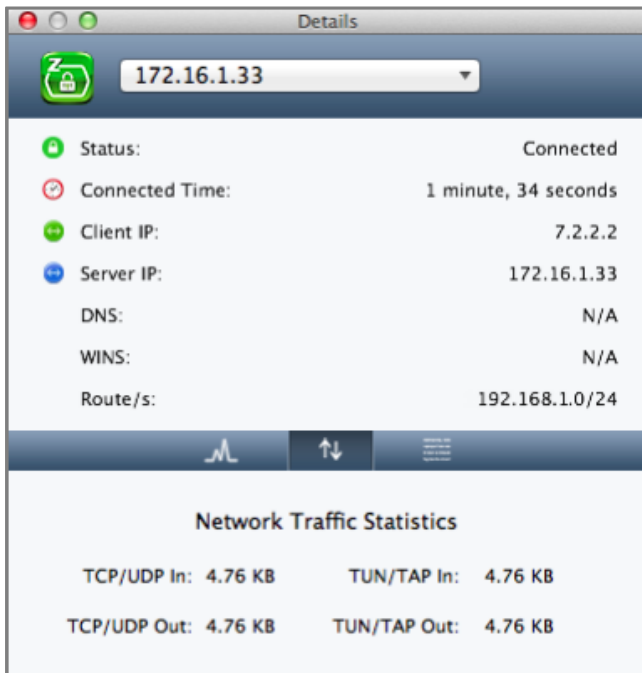

ZyWALL SecuExtender > Details > Log Details

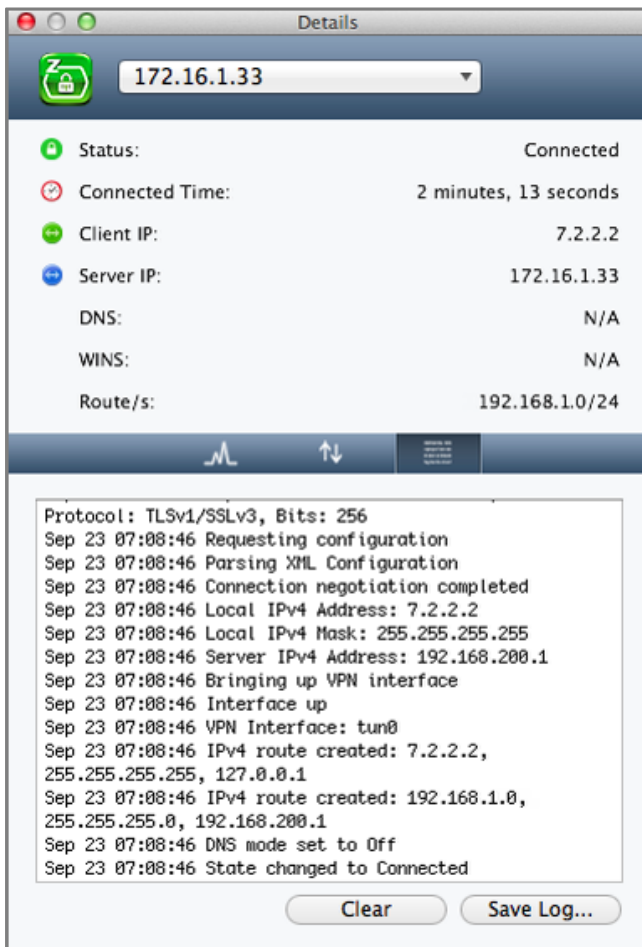

## What Could Go Wrong?

If you see [notice] or [alert] log message such as below, please check ZyWALL/USG SSL **Selected User/Group Objects** settings. MAC OS X 10.10 Yosemite users must use the same **Username** and **Password** as configured in ZyWALL/USG to establish the SSL VPN tunnel.

Priority	Category	Message	Note
notice	SSL VPN	Failed login attempt to SSLVPN from http/https (incorrect password or inexistent username)	Account: SSL_VPN_1...
alert	User	Failed login attempt to Device from http/https (incorrect password or inexistent username)	Account: SSL_VPN_1...



If you uploaded a logo to show in the SSL VPN user screens but it does not display properly, check that the logo graphic is in GIF, JPG, or PNG format. The graphic should use a resolution of 103 x 29 pixels to avoid distortion when displayed. The ZyWALL/USG automatically resizes a graphic of a different resolution to 103 x 29 pixels. The file size must be 100 kilobytes or less. Transparent background is recommended.

If users can log into the SSL VPN but cannot see some of the resource links check the SSL application object's configuration.

If the ZyWALL/USG redirects the user to the user aware screen, check whether the user account is included in an SSL VPN access policy or not.

Changing the HTTP/HTTPS configuration disconnects SSL VPN network extension sessions. Users need to re-connect if this happens.

## How To Configure SSL VPN for Remote Access Mobile Devices

This is an example of using the ZyWALL/USG SSL VPN for remote access mobile devices to securely connect to the File Sharing Server behind the ZyWALL/USG.

ZyWALL/USG SSL VPN for Secure External Access to Network Resources

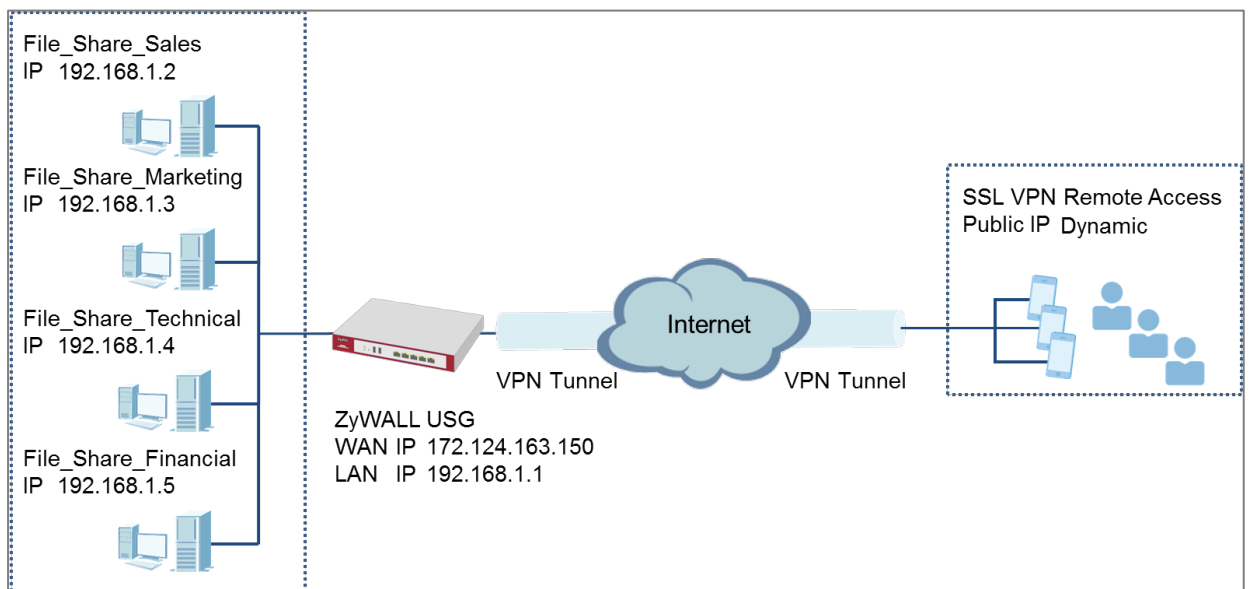

 Note: All network IP addresses and subnet masks are used as examples in this article. Please replace them with your actual network IP addresses and subnet masks. This example was tested using USG1900 (Firmware Version: ZLD 4.25).

## Set Up the SSL VPN Tunnel on the ZyWALL/USG

In the ZyWALL/USG, go to **CONFIGURATION > VPN > SSL VPN > Access Privilege** to add an **Access Policy**. Configure a **Name** for you to identify the SSL VPN configuration.

**CONFIGURATION > VPN > SSL VPN > Access Privilege > Access Policy > Configuration**

Configuration	
<input checked="" type="checkbox"/> Enable Policy	
Name:	<input type="text" value="SSL_VPN_1"/>
Zone:	<input type="text" value="SSL_VPN"/> ⓘ
Description:	<input type="text" value="New Create"/> (Optional)

Go to **Create new Object > User** to add **User Name** (SSL\_VPN\_1\_Users in this example) and **Password** (4-24 characters, zyx168 in this example), click **OK**.

**CONFIGURATION > VPN > SSL VPN > Access Privilege > Access Policy > Create new Object > User**

**+ Add Access Policy**

Create new Object ▾

- User
- Application
- Address

Name:

Zone:  ⓘ

Description:  (Optional)

**+ Add A User** ⓘ

**User Configuration**

User Name :

User Type:  ▾

Password:

Retype:

Description:

OK Cancel

Go to **Create new Object > Application** to add servers that you will allow **SSL\_VPN\_1\_Users** to access. Click **OK**.

**CONFIGURATION > VPN > SSL VPN > Access Privilege > Access Policy > Create new Object > Application**

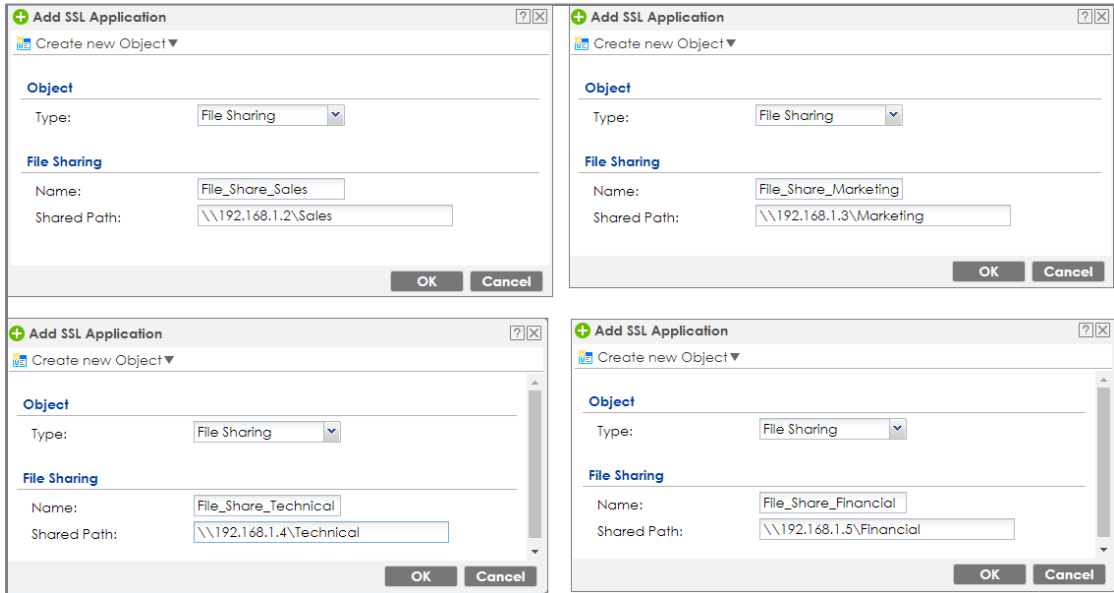

Then, move the just created address object to **Selected User/Group Objects**.

Similarly, in **SSL Application List (Optional)** move the servers you want available to SSL users to **Selected Application Objects**.

**CONFIGURATION > VPN > SSL VPN > Access Privilege > Access Policy > User/Group & SSL Application**

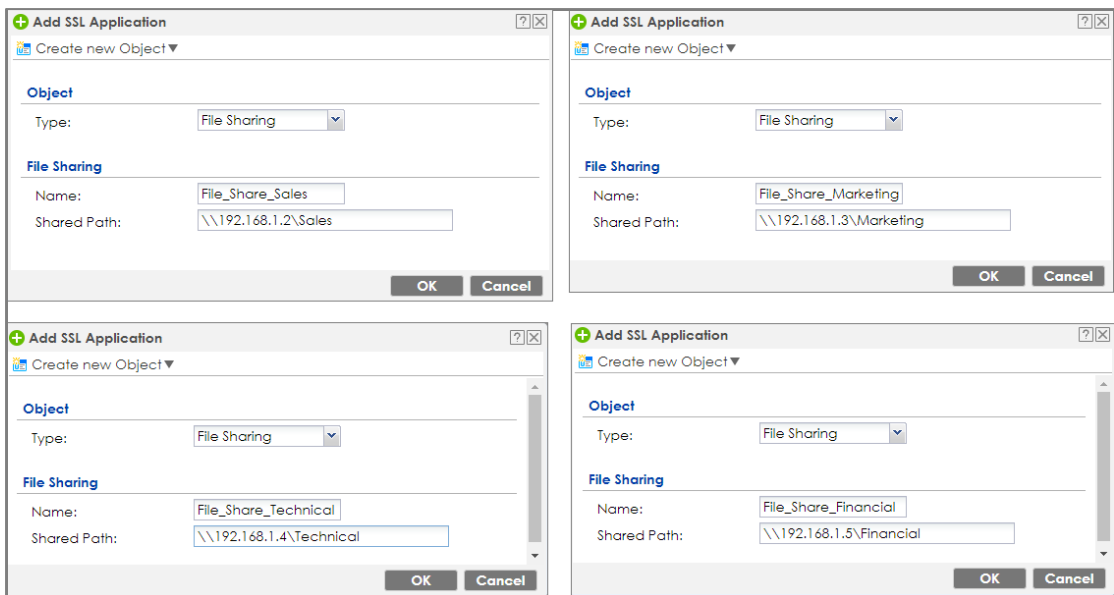

## Test the SSL VPN Tunnel

Type the ZyWALL/USG's WAN IP into the browser, then the login screen appears.

Enter **User Name** and **Password** to be the same as your ZyWALL/USG **SSL VPN Selected User/Group** name and password (SSL\_VPN\_1\_Users/zyx168 in this example). Click **SSL VPN**.

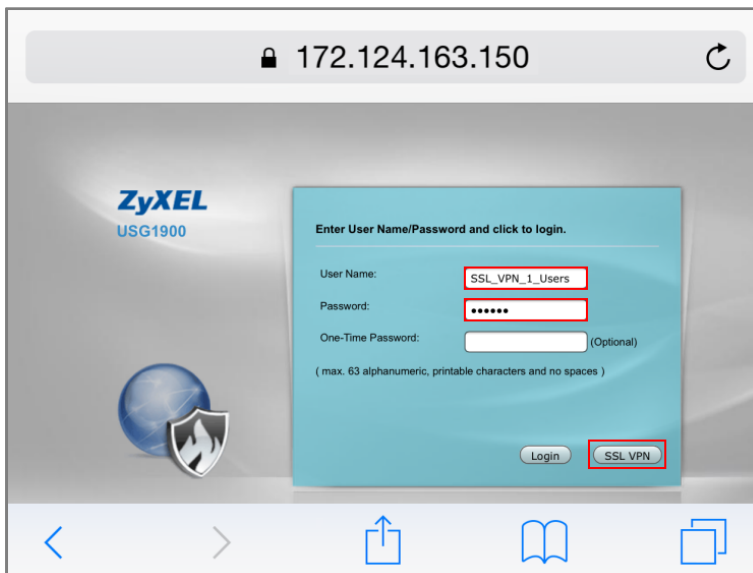

The **File Sharing** server appears.

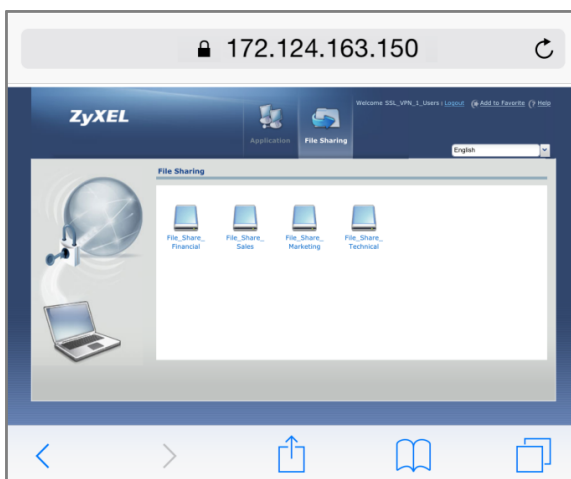

Click the **File Sharing** folder you want to access, enter **User Name/ Password** of your **File Sharing** server and click **Login**.

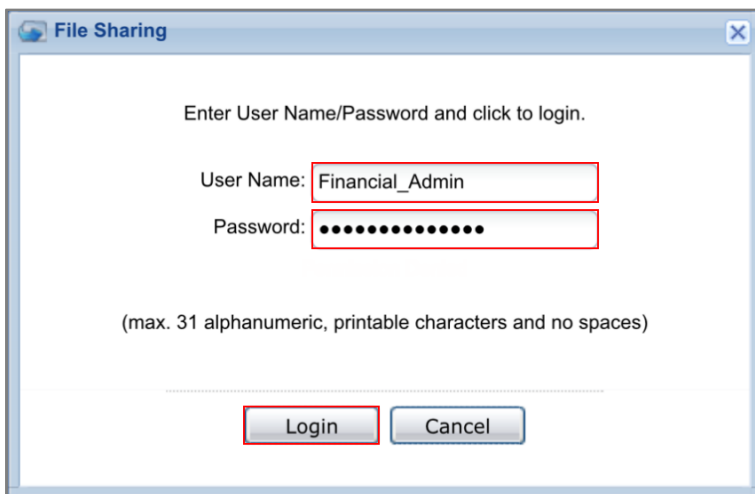

A dialog box titled "File Sharing" with a close button in the top right corner. The text inside reads: "Enter User Name/Password and click to login." Below this, there are two input fields: "User Name:" containing "Financial\_Admin" and "Password:" containing ten black dots. A note below the fields says "(max. 31 alphanumeric, printable characters and no spaces)". At the bottom, there are two buttons: "Login" and "Cancel".

Now you can securely access the files.

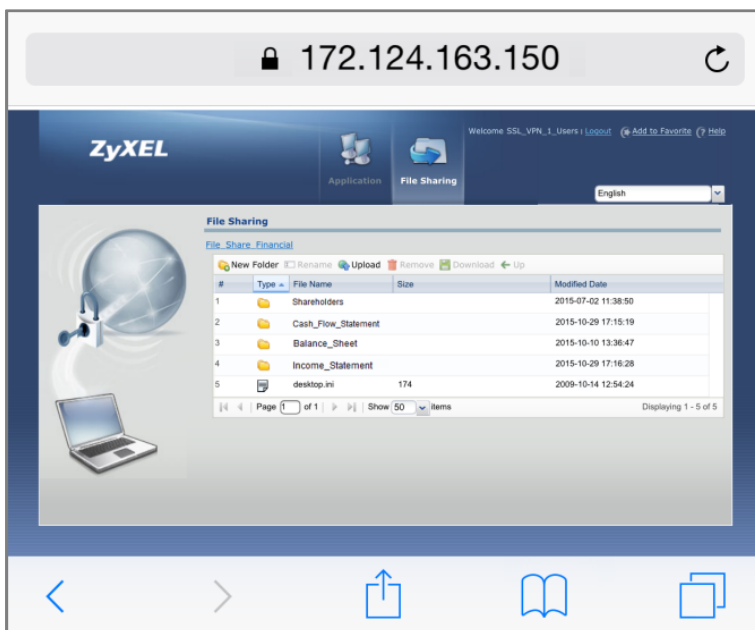

A screenshot of a web browser showing the ZyXEL File Sharing interface. The address bar displays "172.124.163.150". The page header includes the ZyXEL logo, "Application" and "File Sharing" tabs, and a language dropdown set to "English". The main content area is titled "File Sharing" and shows a file list for "File\_Share\_Financial". The list includes folders like "Shareholders", "Cash\_Flow\_Statement", "Balance\_Sheet", and "Income\_Statement", and a file named "desktop.ini". A navigation bar at the bottom contains icons for back, forward, upload, and other functions.

#	Type	File Name	Size	Modified Date
1	Folder	Shareholders		2015-07-02 11:38:50
2	Folder	Cash_Flow_Statement		2015-10-29 17:15:19
3	Folder	Balance_Sheet		2015-10-10 13:36:47
4	Folder	Income_Statement		2015-10-29 17:16:28
5	File	desktop.ini	174	2009-10-14 12:54:24

## What Could Go Wrong?

If you see [notice] or [alert] log message such as below, please check ZyWALL/USG SSL **Selected User/Group Objects** settings. Windows 10 users must use the same **Username** and **Password** as configured in ZyWALL/USG to establish the SSL VPN tunnel.

Priority	Category	Message	Note
notice	SSL VPN	Failed login attempt to SSLVPN from http/https (incorrect password or inexistent username)	Account: SSL_VPN_1...
alert	User	Failed login attempt to Device from http/https (incorrect password or inexistent username)	Account: SSL_VPN_1...

If you uploaded a logo to show in the SSL VPN user screens but it does not display properly, check that the logo graphic is in GIF, JPG, or PNG format. The graphic should use a resolution of 103 x 29 pixels to avoid distortion when displayed. The ZyWALL/USG automatically resizes a graphic of a different resolution to 103 x 29 pixels. The file size must be 100 kilobytes or less. Transparent background is recommended.

If users can log into the SSL VPN but cannot see some of the resource links check the SSL application object's configuration.

If the ZyWALL/USG redirects the user to the user aware screen, check whether the user account is included in an SSL VPN access policy or not.

Changing the HTTP/HTTPS configuration disconnects SSL VPN network extension sessions. Users need to re-connect if this happens.



## How to Configure an SSL VPN Tunnel (with SecuExtender version 4.0.0.1) on the Windows 10 Operating System

### Set up the SSL VPN Tunnel with Windows 10

Please download SecuExtender version 4.0.0.1 from the download library of ZyXEL's official website.

Model	Material	Version	OS	Checksum	Release Date	Release Note	Download
ZyWALL IPsec VPN Client	Software	ZyWALLIPSecVPNClient3.7204.6113	Windows 7 32bit/ Windows 7 64bit/ Windows 8 32bit/ Windows 8 64bit/ Windows 10 32bit/ Windows 10 64bit		May 24, 2017		
SecuExtender	Software	SecuExtender_MacOSX115	Mac 10X/ MAC 10.8/ MAC 10.9/ MAC 10.10		Mar 15, 2017		
SecuExtender	Software	SecuExtender_Windows4.0.2.0	Windows XP/ Windows 7 32bit/ Windows 7 64bit/ Windows 8 32bit/ Windows 8 64bit/ Windows 10 32bit/ Windows 10 64bit		Jan 18, 2017		

Before you start installing the SecuExtender, it is required to install the "Visual C++ 2015 Redistributable" package first. Click **Next**, select **I agree to the license terms and conditions**, and click **Install** to complete the Visual C++ 2015 Redistributable installation. After that, the setup wizard appears. Please note that the users need to reboot their systems after the SecuExtender installation is completed.

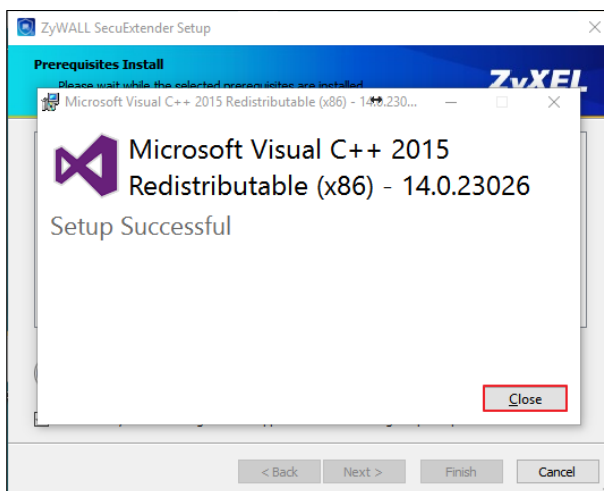
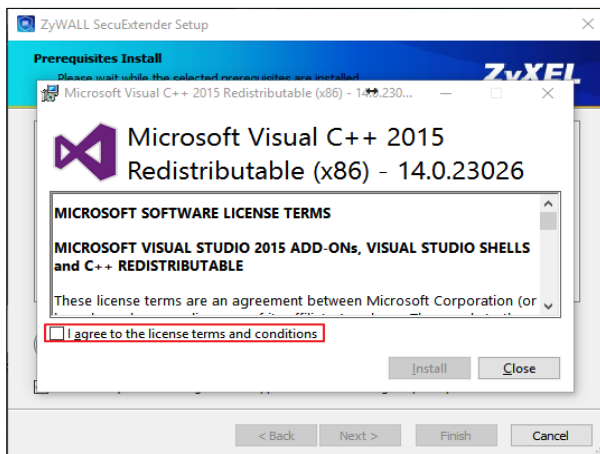
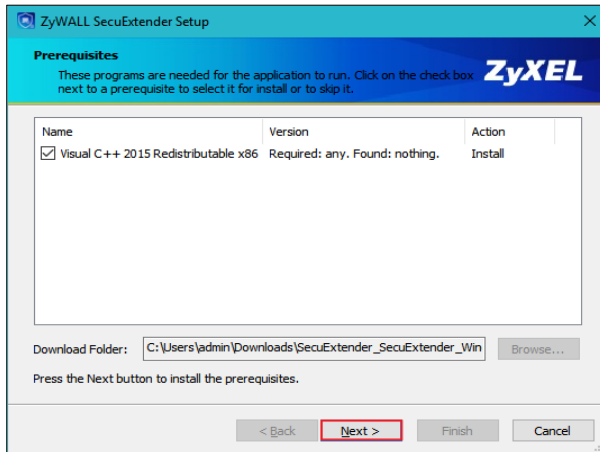

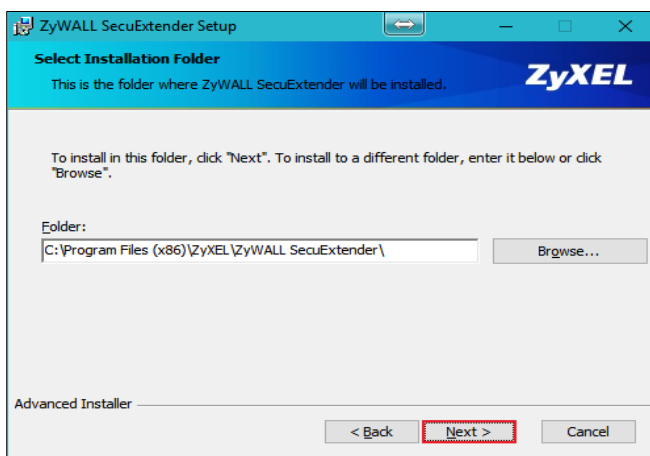
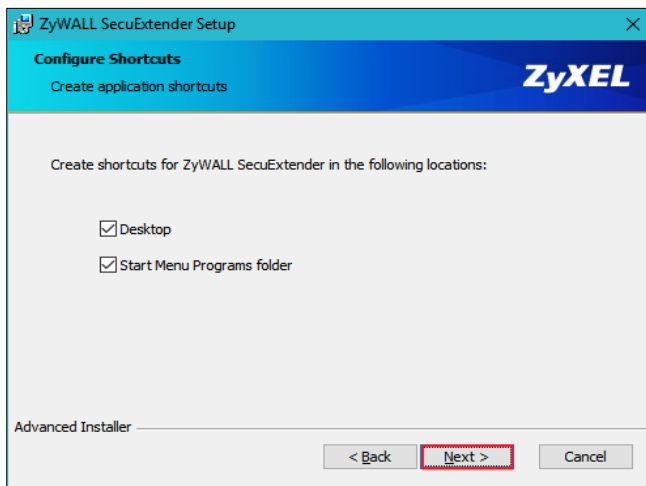
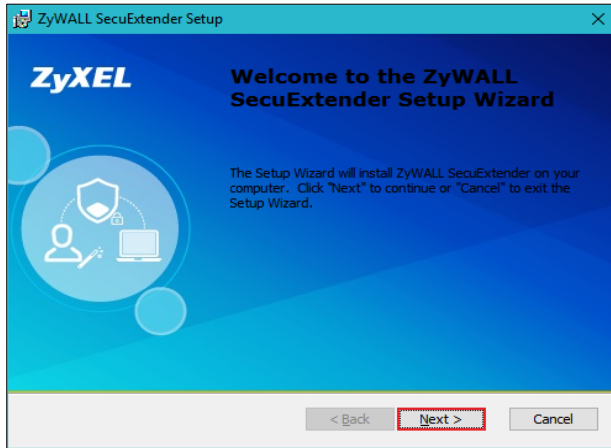

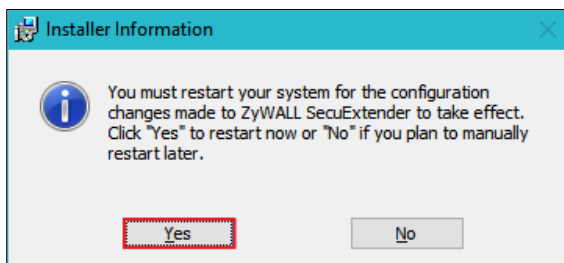
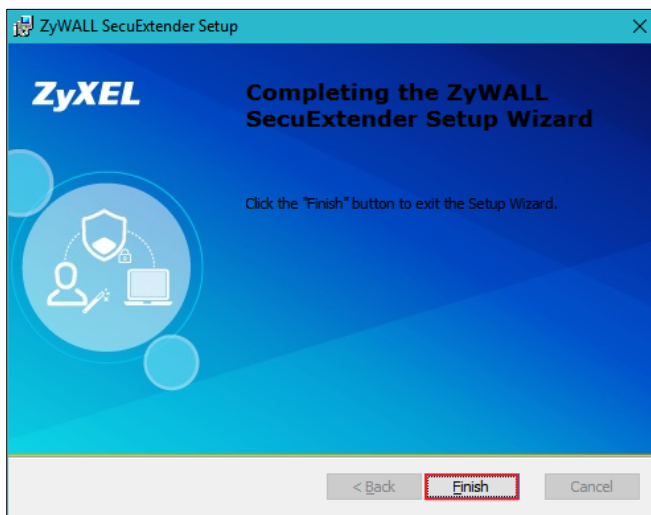
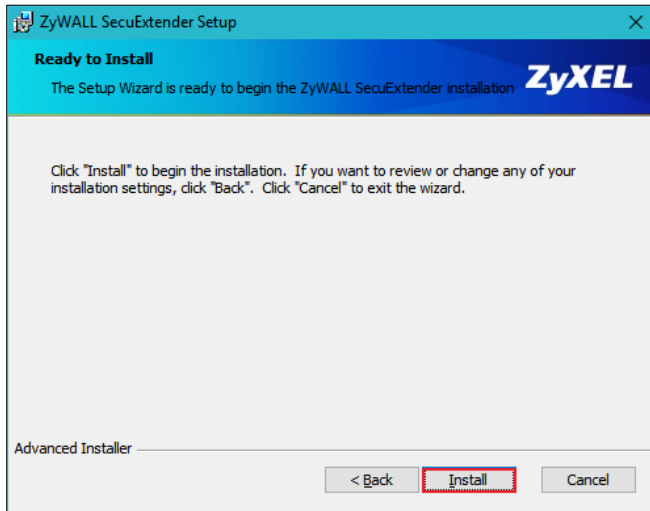

Double-click the shortcut icon on your desktop. It is the same as the SSL VPN standalone software on MAC OS X. Enter the server's IP or domain name, user name, and password to connect to the server. The example below shows that the client IP is **7.7.7.1** and you can also check the traffic statistic in the **Status** screen.

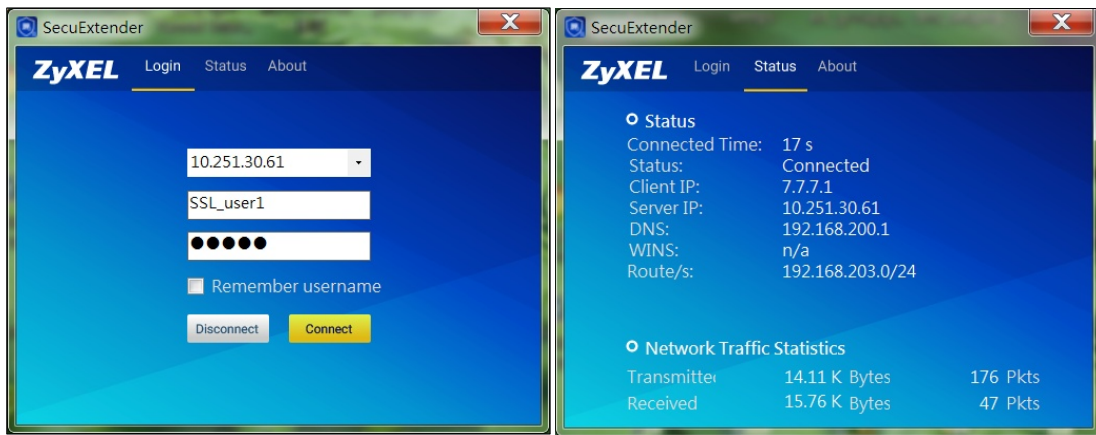

You can verify the connection status from the computer's taskbar icon.



When connected, the icon is blue.



When disconnected, the icon is red.

You can also use the USG monitor screen to check the login list of the users.

Current User List						
#	User ID	Reauth/Lease Time	Type	IP Address	MAC	User Info
1	SSL_user1	23:59:17 / 23:59:47	SSLVPN	10.251.30.56/7.7.7.1	3C:97:0E:30:0E:B8	user(SSL_user1)

## What Can Go Wrong?

- 1 If you see a [notice] or [alert] log message such as shown below, please check the ZyWALL/USG SSL's **Selected User/Group Objects** settings. Windows 10 users must use the same **Username** and **Password** as configured in the ZyWALL/USG to establish the SSL VPN tunnel.

Priority	Category	Message	Note
notice	SSL VPN	Failed login attempt to SSLVPN from http/https (incorrect password or inexistent username)	Account: SSL_VPN_1_Users
alert	User	Failed login attempt to Device from http/https (incorrect password or inexistent username)	Account: SSL_VPN_1_Users

- 2 If you have uploaded a logo to show on the SSL VPN user screens but it does not display properly, check if the logo graphic is in GIF, JPG, or PNG format. The graphic should use a resolution of 103 x 29 pixels to avoid distortion when displayed. The ZyWALL/USG automatically resizes a graphic of a different resolution to 103 x 29 pixels. The file size must be 100 kilobytes or less. Transparent background is recommended.
- 3 If users can log into the SSL VPN but cannot see some of the resource links, check the SSL application object's configurations.
- 4 If the ZyWALL/USG redirects the user to the user aware screen, check whether the user account is included in an SSL VPN access policy or not.
- 5 If you have changed the HTTP/HTTPS configuration, the SSL VPN network extension sessions will be disconnected. The sessions need to be reconnected if this happens.

## How to redirect multiple LAN interface traffic to the VPN tunnel

This example shows how to use the VPN Setup Wizard to create a site-to-site VPN with multiple LAN access to the VPN tunnel. The example instructs how to configure the VPN tunnel between each site and redirect multiple LAN interface traffic to the VPN tunnel. When the VPN tunnel is configured, multiple LAN subnets can be accessed securely.

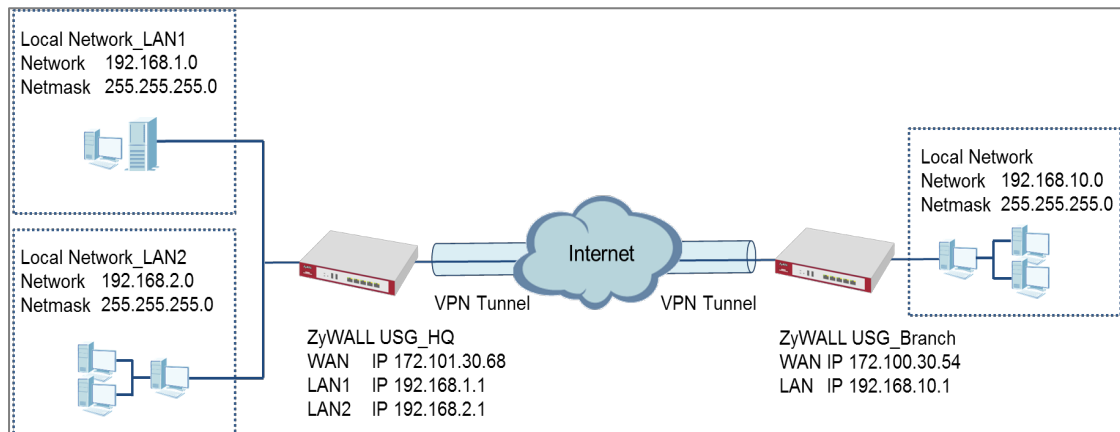

ZyWALL Site-to-site IPsec VPN with multiple LAN access

 Note: All network IP addresses and subnet masks are used as examples in this article. Please replace them with your actual network IP addresses and subnet masks. This example was tested using USG310 (Firmware Version: ZLD 4.25).

## Set Up the ZyWALL/USG IPsec VPN Tunnel of Corporate Network (HQ)

In the ZyWALL/USG, go to **Quick Setup > VPN Setup Wizard**, use the **VPN Settings** wizard to create a VPN rule that can be used with the remote ZyWALL/USG. Click **Next**.

### Quick Setup > VPN Setup Wizard > Welcome

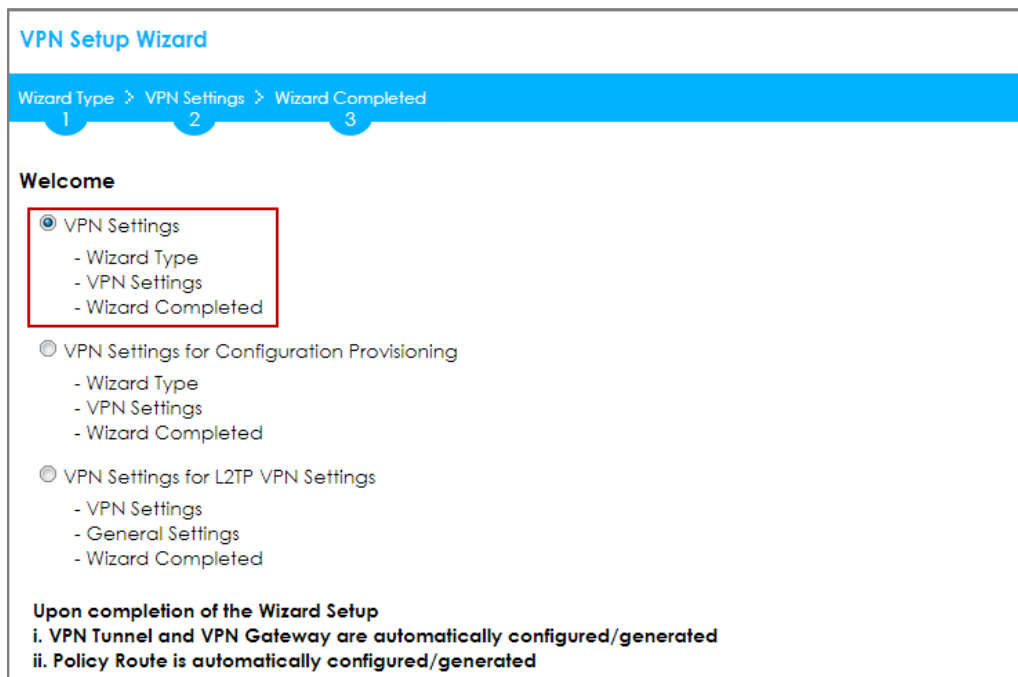

Choose **Express** to create a VPN rule with the default phase 1 and phase 2 settings and use a pre-shared key to be the authentication method. Click **Next**.

### Quick Setup > VPN Setup Wizard > Wizard Type



**VPN Setup Wizard**

Wizard Type > VPN Settings > Wizard Completed

1 2 3

Please select the type of VPN policy you wish to setup.

Type of VPN policy

Express

Advanced

Type the **Rule Name** used to identify this VPN connection (and VPN gateway). You may use 1-31 alphanumeric characters. This value is case-sensitive. Select the rule to be **Site-to-site**. Click **Next**.

**Quick Setup > VPN Setup Wizard > Wizard Type > VPN Settings (Scenario)**

**VPN Setup Wizard**

Wizard Type > VPN Settings > Wizard Completed

1 2 3

**Express Settings**

**IKE Version**

IKEv1

IKEv2

**Scenario**

Rule Name:

Site-to-site

Site-to-site with Dynamic Peer

Remote Access (Server Role)

Remote Access (Client Role)

Configure **Secure Gateway** IP as the peer ZyWALL/USG's WAN IP address (in the example, 172.100.30.54). Type a secure **Pre-Shared Key** (8-32 characters).

Set **Local Policy** to be the IP address range of the network connected to the ZyWALL/USG and **Remote Policy** to be the IP address range of the network connected to the peer ZyWALL/USG.

**Quick Setup > VPN Setup Wizard > Wizard Type > VPN Settings (Configuration)**

### VPN Setup Wizard

Wizard Type > **VPN Settings** > Wizard Completed

1
2
3

#### Express Settings

##### Configuration

Secure Gateway:	10.214.30.77	(IP or FQDN)
Pre-Shared Key:	zyxel123	
Local Policy (IP/Mask):	192.168.1.0	/255.255.255.0
Remote Policy (IP/Mask):	192.168.10.0	/255.255.255.0

This screen provides a read-only summary of the VPN tunnel. Click **Save**.

**Quick Setup > VPN Setup Wizard > Welcome > Wizard Type > VPN Settings (Summary)**

### VPN Setup Wizard

Wizard Type > **VPN Settings** > Wizard Completed

1
2
3

#### Express Settings

##### Summary

Rule Name:	WIZ_VPN_HQ
Secure Gateway:	10.214.30.77
Pre-Shared Key:	zyxel123
Local Policy (IP/Mask):	192.168.1.0 / 255.255.255.0
Remote Policy (IP/Mask):	192.168.10.0 / 255.255.255.0

Now the rule is configured on the ZyWALL/USG. The Phase 1 rule settings appear in the **VPN > IPSec VPN > VPN Gateway** screen and the Phase 2 rule settings appear in the **VPN > IPSec VPN > VPN Connection** screen. Click **Close** to exit the wizard.

**Quick Setup > VPN Setup Wizard > Welcome > Wizard Type > VPN Settings > Wizard Completed**

**VPN Setup Wizard**

Wizard Type > VPN Settings > **Wizard Completed**

1      2      **3**

**Express Settings**

Congratulations. The VPN Access wizard is completed

Summary

Rule Name:	WIZ_VPN_HQ
Secure Gateway:	10.214.30.77
Pre-Shared Key:	zyxel123
Local Policy (IP/Mask):	192.168.1.0 / 255.255.255.0
Remote Policy (IP/Mask):	192.168.10.0 / 255.255.255.0

Go to **CONFIGURATION > VPN > IPSec VPN > VPN Gateway** and click **Show Advanced Settings**. Configure **Authentication > Peer ID Type** as **Any** to let the ZyWALL/USG does not require to check the identity content of the remote IPSec router.

**CONFIGURATION > VPN > IPSec VPN > VPN Gateway > Show Advanced Settings > Authentication > Peer ID Type**

**Authentication**

Pre-Shared Key   
 unmasked

Certificate  (See [My Certificates](#))

User Based PSK  ⓘ

⊕ Advance

Local ID Type:

Content:

Peer ID Type:

Content:

## Set Up the ZyWALL/USG IPSec VPN Tunnel of Corporate Network (Branch)

In the ZyWALL/USG, go to **Quick Setup > VPN Setup Wizard**, use the **VPN Settings** wizard to create a VPN rule that can be used with the remote ZyWALL/USG. Click **Next**.

## Quick Setup > VPN Setup Wizard > Welcome

VPN Setup Wizard

Wizard Type > VPN Settings > Wizard Completed

1 2 3

**Welcome**

- VPN Settings
  - Wizard Type
  - VPN Settings
  - Wizard Completed
- VPN Settings for Configuration Provisioning
  - Wizard Type
  - VPN Settings
  - Wizard Completed
- VPN Settings for L2TP VPN Settings
  - VPN Settings
  - General Settings
  - Wizard Completed

Upon completion of the Wizard Setup

- i. VPN Tunnel and VPN Gateway are automatically configured/generated
- ii. Policy Route is automatically configured/generated

Choose **Express** to create a VPN rule with the default phase 1 and phase 2 settings and to use a pre-shared key. Click **Next**.

## Quick Setup > VPN Setup Wizard > Wizard Type

VPN Setup Wizard

Wizard Type > VPN Settings > Wizard Completed

1 2 3

Please select the type of VPN policy you wish to setup.

**Type of VPN policy**

- Express
- Advanced

Type the **Rule Name** used to identify this VPN connection (and VPN gateway). You may use 1-31 alphanumeric characters. This value is case-sensitive. Click **Next**.

## Quick Setup > VPN Setup Wizard > Wizard Type > VPN Settings (Scenario)

### VPN Setup Wizard

Wizard Type > VPN Settings > Wizard Completed

1
2
3

#### Express Settings

**IKE Version**

IKEv1

IKEv2

**Scenario**

Rule Name:

Site-to-site

Site-to-site with Dynamic Peer

Remote Access (Server Role)

Remote Access (Client Role)

Configure **Secure Gateway** IP as the peer ZyWALL/USG's WAN IP address (in the example, 172.101.30.68). Type a secure **Pre-Shared Key** (8-32 characters).

Set **Local Policy** to be the IP address range of the network connected to the ZyWALL/USG and **Remote Policy** to be the IP address range of the network connected to the peer ZYWALL/USG.

**Quick Setup > VPN Setup Wizard > Wizard Type > VPN Settings (Configuration)**

### VPN Setup Wizard

Wizard Type > VPN Settings > Wizard Completed

1
2
3

#### Express Settings

**Configuration**

Secure Gateway:  (IP or FQDN)

Pre-Shared Key:

Local Policy (IP/Mask):  /

Remote Policy (IP/Mask):  /

This screen provides a read-only summary of the VPN tunnel. Click **Save**.

**Quick Setup > VPN Setup Wizard > Welcome > Wizard Type > VPN Settings (Summary)**

**VPN Setup Wizard**

[Wizard Type](#) > [VPN Settings](#) > [Wizard Completed](#)  
1   2   3

**Express Settings**

**Summary**

Rule Name:	WIZ_VPN_Branch
Secure Gateway:	10.214.30.106
Pre-Shared Key:	zyxel123
Local Policy (IP/Mask):	192.168.10.0 / 255.255.255.0
Remote Policy (IP/Mask):	192.168.1.0 / 255.255.255.0

Now the rule is configured on the ZyWALL/USG. The Phase 1 rule settings appear in the **VPN > IPSec VPN > VPN Gateway** screen and the Phase 2 rule settings appear in the **VPN > IPSec VPN > VPN Connection** screen. Click **Close** to exit the wizard.

**Quick Setup > VPN Setup Wizard > Welcome > Wizard Type > VPN Settings > Wizard Completed**

**VPN Setup Wizard**

[Wizard Type](#) > [VPN Settings](#) > [Wizard Completed](#)  
1   2   3

**Express Settings**

Congratulations. The VPN Access wizard is completed

**Summary**

Rule Name:	WIZ_VPN_Branch
Secure Gateway:	10.214.30.106
Pre-Shared Key:	zyxel123
Local Policy (IP/Mask):	192.168.10.0 / 255.255.255.0
Remote Policy (IP/Mask):	192.168.1.0 / 255.255.255.0

Go to **CONFIGURATION > VPN > IPSec VPN > VPN Gateway** and click **Show Advanced Settings**. **Configure Authentication > Peer ID Type** as **Any** to let the ZyWALL/USG does not require to check the identity content of the remote IPSec router.

**CONFIGURATION > VPN > IPSec VPN > VPN Gateway > Show Advanced Settings > Authentication > Peer ID Type**

**Authentication**

Pre-Shared Key   
 unmasked

Certificate  (See [My Certificates](#))

User Based PSK  ⓘ

Advance

Local ID Type:

Content:

Peer ID Type:

Content:

## Set up the Policy Route (ZyWALL/USG\_HQ)

Go to ZyWALL/USG\_HQ **CONFIGURATION > Network > Routing > Add**. Set **Source Address** to be the subnet (192.168.2.0/24 in this example) allows joining the VPN tunnel. Set **Destination Address** to be the remote LAN subnet (192.168.10.0/24 in this example).

**CONFIGURATION > Network > Routing > Add**

**Add Policy Route**

Show Advanced Settings Create new Object ▼

**Configuration**

Enable

Description:  (Optional)

**Criteria**

User: any

Incoming: any (Excluding ZyV)

Source Address: LAN2\_SUBNET

Destination Address: WIZ\_VPN\_HQ\_REM

DSCP Code: any

Schedule: none

Service: any

**Next-Hop**

Type: VPN Tunnel

VPN Tunnel: WIZ\_VPN\_HQ

OK Cancel

## Set up the Policy Route (ZyWALL/USG\_Branch)

Go to ZyWALL/USG\_Branch **CONFIGURATION > Network > Routing > Add**, create **Address** to be the remote LAN subnet (192.168.2.0/24 in this example) allows joining the VPN tunnel.

**CONFIGURATION > Object > Address > Add**



**+ Add Address Rule** [?] [X]

Name:

Address Type:

Network:

Netmask:

Go to ZyWALL/USG\_Branch **CONFIGURATION > Network > Routing > Add**. Set **Source Address** to be the local subnet (192.168.10.0/24 in this example). Set **Destination Address** to be the remote LAN subnet (192.168.2.0/24 in this example) allows joining the VPN tunnel.

### CONFIGURATION > Network > Routing > Add

**+ Add Policy Route** [?] [X]

Show Advanced Settings Create new Object ▼

**Configuration**

Enable

Description:  (Optional)

**Criteria**

User:

Incoming:

Source Address:

Destination Address:

DSCP Code:

Schedule:

Service:

**Next-Hop**

Type:

VPN Tunnel:

## Test the IPsec VPN Tunnel

Go to ZYWALL/USG **CONFIGURATION > VPN > IPsec VPN > VPN Connection**, click **Connect** on the upper bar. The **Status** connect icon is lit when the interface is connected.

### CONFIGURATION > VPN > IPsec VPN > VPN Connection

IPv4 Configuration				
#	Status	Name	VPN Gateway	Policy
1		WIZ_VPN_HQ	WIZ_VPN_HQ	WIZ_VPN_HQ_LOCAL/WIZ_VPN_...

Go to ZyWALL/USG **MONITOR > VPN Monitor > IPsec** and verify the tunnel **Up Time** and **Inbound(Bytes)/Outbound(Bytes)** Traffic.

### MONITOR > VPN Monitor > IPsec

#	Serial Num...	System Na...	Name	Policy	My Address	Secure G...	Up Time	Timeout	Inbound(B...	Outbound...
1	S162L44290	VPN100	WIZ_VPN_...	192.168.1.0/24<...	10.214.30...	P: 10.214.3...	1260	72180	31(1674 b...	31(1860 b...

To test whether or not a tunnel is working, ping from a computer at one site to a computer at the other. Ensure that both computers have Internet access (via the IPsec devices).

#### PC at HQ Office > Window 7 > cmd > ping 192.168.10.33

```
C:\Documents and Settings\ZyXEL>ping 192.168.10.33

Pinging 192.168.10.33 with 32 bytes of data:

Reply from 192.168.10.33: bytes=32 time=18ms TTL=54
Reply from 192.168.10.33: bytes=32 time=17ms TTL=54
Reply from 192.168.10.33: bytes=32 time=17ms TTL=54
Reply from 192.168.10.33: bytes=32 time=16ms TTL=54

Ping statistics for 192.168.10.33:
    Packets: Sent = 4, Received = 4, Lost = 0 (0% loss),
    Approximate round trip times in milli-seconds:
        Minimum = 16ms, Maximum = 18ms, Average = 17ms
```

#### PC at Branch Office > Window 7 > cmd > ping 192.168.1.33

```
C:\Documents and Settings\ZyXEL>ping 192.168.1.33

Pinging 192.168.1.33 with 32 bytes of data:

Reply from 192.168.1.33: bytes=32 time=27ms TTL=43
Reply from 192.168.1.33: bytes=32 time=32ms TTL=43
Reply from 192.168.1.33: bytes=32 time=26ms TTL=43
Reply from 192.168.1.33: bytes=32 time=27ms TTL=43

Ping statistics for 192.168.1.33:
    Packets: Sent = 4, Received = 4, Lost = 0 (0% loss),
Approximate round trip times in milli-seconds:
    Minimum = 26ms, Maximum = 32ms, Average = 28ms
```

PC at Branch Office > Window 7 > cmd > ping 192.168.2.33

```
C:\Documents and Settings\ZyXEL>ping 192.168.2.33

Pinging 192.168.2.33 with 32 bytes of data:

Reply from 192.168.2.33: bytes=32 time=27ms TTL=43
Reply from 192.168.2.33: bytes=32 time=27ms TTL=43
Reply from 192.168.2.33: bytes=32 time=26ms TTL=43
Reply from 192.168.2.33: bytes=32 time=32ms TTL=43

Ping statistics for 192.168.2.33:
    Packets: Sent = 4, Received = 4, Lost = 0 (0% loss),
Approximate round trip times in milli-seconds:
    Minimum = 26ms, Maximum = 32ms, Average = 28ms
```

## What Could Go Wrong?

If you see below [info] or [error] log message, please check ZyWALL/USG Phase 1 Settings. Both ZyWALL/USG at the HQ and Branch sites must use the same Pre-Shared Key, Encryption, Authentication method, DH key group and ID Type to establish the IKE SA.

**MONITOR > Log**

Priority	Category	Message	Note
info	IKE	[COOKIE] Invalid cookie, no sa found	IKE_LOG
Priority	Category	Message	Note
info	IKE	Recv:[NOTIFY:NO_PROPOSAL_CHOSEN]	IKE_LOG
info	IKE	[SA] : Tunnel [HQ1] Phase 1 proposal mismatch	IKE_LOG

If you see that Phase 1 IKE SA process done but still get below [info] log message, please check ZyWALL/USG Phase 2 Settings. Both ZyWALL/USG at the HQ and Branch sites must use the same Protocol, Encapsulation, Encryption, Authentication method and PFS to establish the IKE SA.

### MONITOR > Log

Priority	Cate...	Message	Note
info	IKE	Recv:[HASH][NOTIFY:NO_PROPOSAL_CHOSEN]	IKE_LOG
info	IKE	Send:[HASH][SA][NONCE][ID][ID]	IKE_LOG
info	IKE	Send:[HASH][NOTIFY:NO_PROPOSAL_CHOSEN]	IKE_LOG
info	IKE	[SA] : No proposal chosen	IKE_LOG
info	IKE	[SA] : Tunnel [BO1] Phase 2 proposal mismatch	IKE_LOG
info	IKE	Recv:[HASH][SA][NONCE][ID][ID]	IKE_LOG
info	IKE	Phase 1 IKE SA process done	IKE_LOG

Make sure the both ZyWALL/USG at the HQ and Branch sites security policies allow IPSec VPN traffic. IKE uses UDP port 500, AH uses IP protocol 51, and ESP uses IP protocol 50.

Default NAT traversal is enable on ZyWALL/USG, please make sure the remote IPSec device must also have NAT traversal enabled.

## How to Create VTI and Configure VPN Failover with VTI

This example illustrates how to create a VTI object and configure a policy route with the VTI. Furthermore, it applies the VTI to the WAN trunk to achieve VPN load balancing.

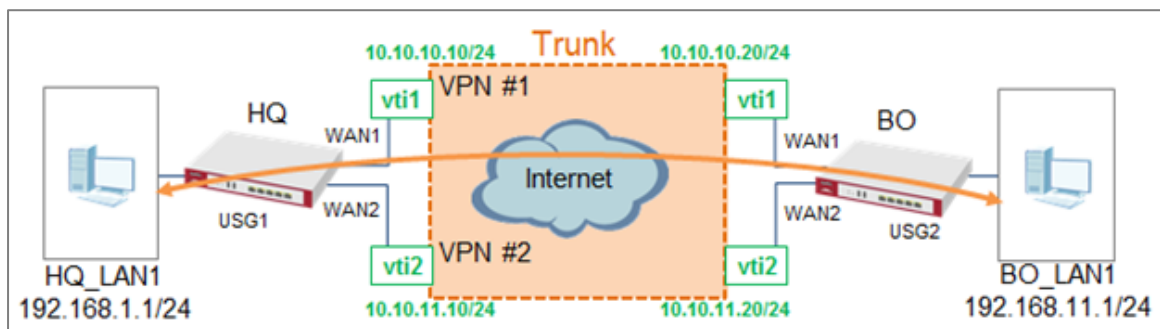

VPN Load Balance with VTI

 Note: All network IP addresses and subnet masks are used as examples in this article. Please replace them with your actual network IP addresses and subnet masks. This example was tested using USG110 (Firmware Version: ZLD 4.25).

### VTI Deployment Flow

- 1 Configure the VPN gateways.
- 2 Configure a VPN tunnel for each VPN gateway with the application scenario VPN Tunnel Interface.
- 3 Create a VTI for each VPN tunnel.
- 4 Create a trunk with the VTIs.
- 5 Configure a policy route.
- 6 Connect the VPN tunnels.

## Set Up the ZyWALL/USG VTI of Corporate Network (HQ)

1 In the ZyWALL/USG, go to **CONFIGURATION > VPN > IPSec VPN > VPN Gateway > Add** to create the VPN gateway **HQ1** with **wan1**.

**CONFIGURATION > VPN > IPSec VPN > VPN Gateway > Add**

The screenshot shows the configuration page for a new VPN Gateway named 'HQ1'. The 'General Settings' section has 'Enable' checked and 'VPN Gateway Name' set to 'HQ1'. Under 'IKE Version', 'IKEv1' is selected. The 'Gateway Settings' section has 'My Address' set to 'Interface' (wan1) and 'Peer Gateway Address' set to 'Static Address' with a primary address of '10.214.30.77'. The 'Authentication' section has 'Pre-Shared Key' selected with a masked key.

2 In the same screen, create the VPN gateway **HQ2** with **wan2**.

**CONFIGURATION > VPN > IPSec VPN > VPN Gateway > Add**

The screenshot shows the configuration page for a new VPN Gateway named 'HQ2'. The 'General Settings' section has 'Enable' checked and 'VPN Gateway Name' set to 'HQ2'. Under 'IKE Version', 'IKEv1' is selected. The 'Gateway Settings' section has 'My Address' set to 'Interface' (wan2) and 'Peer Gateway Address' set to 'Static Address' with a primary address of '10.214.30.84'. The 'Authentication' section has 'Pre-Shared Key' selected with a masked key.

**3** Go to **CONFIGURATION > VPN > IPsec VPN > VPN Connection > Add** and configure a VPN tunnel for the VPN gateway **HQ1**. Select **VPN Tunnel Interface** as the application scenario.

**CONFIGURATION > VPN > IPsec VPN > VPN Connection > Add**

General Settings	
<input checked="" type="checkbox"/> Enable	
Connection Name:	HQ1
<input type="checkbox"/> Advance	
VPN Gateway	
Application Scenario	
<input type="radio"/> Site-to-site	
<input type="radio"/> Site-to-site with Dynamic Peer	
<input type="radio"/> Remote Access (Server Role)	
<input type="radio"/> Remote Access (Client Role)	
<input checked="" type="radio"/> Vpn Tunnel Interface	
VPN Gateway:	HQ1 wan1 10.214.30.77, 0.0.0.0
Phase 2 Setting	
SA Life Time:	86400 (180 - 3000000 Seconds)

**4** In the same screen, create a VPN tunnel for the VPN gateway **HQ2**. Select **VPN tunnel Interface** as the application scenario.

**CONFIGURATION > VPN > IPsec VPN > VPN Connection > Add**

General Settings	
<input checked="" type="checkbox"/> Enable	
Connection Name:	HQ2
<input type="checkbox"/> Advance	
VPN Gateway	
Application Scenario	
<input type="radio"/> Site-to-site	
<input type="radio"/> Site-to-site with Dynamic Peer	
<input type="radio"/> Remote Access (Server Role)	
<input type="radio"/> Remote Access (Client Role)	
<input checked="" type="radio"/> Vpn Tunnel Interface	
VPN Gateway:	HQ2 wan2 10.214.30.84, 0.0.0.0
Phase 2 Setting	
SA Life Time:	86400 (180 - 3000000 Seconds)

5 Go to **CONFIGURATION > Network > Interface > VTI > Add** to create a VTI for the VPN tunnel **HQ1**. Enable the connectivity check. Enter the IP address of **vti1**, which is configured on **USG2**.

**CONFIGURATION > Network > Interface > VTI > Add**

General Settings	
<input checked="" type="checkbox"/> Enable	
Interface Properties	
Interface Name:	<input type="text" value="vti1"/>
Zone:	<input type="text" value="IPSec_VPN"/> ⓘ
vpn-rule:	<input type="text" value="HQ1"/> ⓘ
IP Address Assignment	
IP Address:	<input type="text" value="10.10.10.10"/>
Subnet Mask:	<input type="text" value="255.255.255.0"/>
Metric:	<input type="text" value="0"/> (0-15)

**CONFIGURATION > Network > Interface > VTI > vti1 > Connectivity Check**

Connectivity Check	
<input checked="" type="checkbox"/> Enable Connectivity Check	
Check Method:	<input type="text" value="icmp"/>
Check Period:	<input type="text" value="30"/> (5-600 seconds)
Check Timeout:	<input type="text" value="5"/> (1-10 seconds)
Check Fail Tolerance:	<input type="text" value="5"/> (1-10)
Check this address:	<input type="text" value="10.10.10.20"/>

6 In the same screen, create a VTI for the VPN tunnel **HQ2**.

**CONFIGURATION > Network > Interface > VTI > Add**

General Settings	
<input checked="" type="checkbox"/> Enable	
Interface Properties	
Interface Name:	<input type="text" value="vti2"/>
Zone:	<input type="text" value="IPSec_VPN"/> ⓘ
vpn-rule:	<input type="text" value="HQ2"/> ⓘ
IP Address Assignment	
IP Address:	<input type="text" value="10.10.11.10"/>
Subnet Mask:	<input type="text" value="255.255.255.0"/>
Metric:	<input type="text" value="0"/> (0-15)



**CONFIGURATION > Network > Interface > VTI > vti2 > Connectivity Check**

**Connectivity Check**

Enable Connectivity Check

Check Method:

Check Period:  (5-600 seconds)

Check Timeout:  (1-10 seconds)

Check Fail Tolerance:  (1-10)

Check this address:

**7** Go to **CONFIGURATION > Network > Interface > Trunk > User Configuration > Add** to create a new trunk. Add **vti1** and **vti2** to the new trunk.

**CONFIGURATION > Network > Interface > Trunk > User Configuration > Add**

Name:

Load Balancing Algorithm:

Load Balancing Index(es):

+ Add ✎ Edit ✖ Remove ↔ Move

#	Member	Mode	Egress Bandwidth
1	vti1	Active	1048576 kbps
2	vti2	Active	1048576 kbps

Page 0 of 0 Show 50 items No data to display

**8** Go to **CONFIGURATION > Network > Routing > Policy Route > Add** to configure a policy route.

Source Address: LAN1\_SUBNET (192.168.1.0/24)

Destination Address: BO\_subnet (192.168.11.0/24)

Next-Hop: HQ\_vti\_trunk

SNAT: none

**CONFIGURATION > Network > Routing > Policy Route > Add**

### Configuration

Enable

Description:  (Optional)

---

### Criteria

User:

Incoming:

Source Address:

Destination Address:

DSCP Code:

Schedule:

Service:

---

### Next-Hop

Type:

Trunk:

---

### DSCP Marking

DSCP Marking:

---

### Address Translation

Source Network Address Translation:

9 Connect the VPN tunnels when the VTIs are ready. Go to **CONFIGURATION > VPN > IPsec VPN > VPN Connection** to connect the VPN tunnels.

**CONFIGURATION > VPN > IPsec VPN > VPN Connection > Connect**

**VPN Connection** | VPN Gateway | Concentrator | Configuration Provisioning

---

Global Setting | Configuration Walkthrough | Troubleshooting | Download VPN Client | VPN

Use Policy Route to control dynamic IPsec rules

Ignore "Don't Fragment" setting in IPv4 header

---

**IPv4 Configuration**

+ Add | ✎ Edit | ✖ Remove | 💡 Activate | 🚫 Inactivate | 🌐 **Connect** | 🚫 Disconnect | 📄 Object References

#	Status	Name	VPN Gateway	Policy
1	<span>🟡</span>	HQ1	HQ1	any/any
2	<span>🟡</span>	HQ2	HQ2	any/any

Page 1 of 1 | Show 50 items | Displaying 1 - 2 of 2

10 Go to **CONFIGURATION > Network > Interface > VTI**. You will see that the status of the VTI is up when the corresponding VPN tunnel is established.

**CONFIGURATION > Network > Interface > VTI**

Port Role	Ethernet	PPP	Cellular	Tunnel	VLAN	Bridge	VTI	Trunk
Configuration								
<span>+</span> Add <span>✎</span> Edit <span>✖</span> Remove <span>🔆</span> Activate <span>🔇</span> Inactivate <span>🔗</span> Object References								
#	Status	Name	IP Address	vpn-rule				
1	<span>🔆</span>	vti1	10.10.10.10/24	HQ1				
2	<span>🔆</span>	vti2	10.10.11.10/24	HQ2				
Page 1 of 1   Show 50 items								Displaying 1 - 2 of 2

## Set Up the ZyWALL/USG VTI of Corporate Network (Branch)

1 In the ZyWALL/USG, go to **CONFIGURATION > VPN > IPsec VPN > VPN Gateway > Add** to create the VPN gateway **BO1** with **wan1**.

**CONFIGURATION > VPN > IPsec VPN > VPN Gateway > Add**

**General Settings**

Enable

VPN Gateway Name:

**IKE Version**

IKEv1

IKEv2

---

**Gateway Settings**

**My Address**

Interface  DHCP client -- 10.214.30.77/255.255.252

Domain Name / IPv4

**Peer Gateway Address**

Static Address

Primary

Secondary

Fall back to Primary Peer Gateway when possible

Fall Back Check Interval:  (60-86400 seconds)

Dynamic Address

---

**Authentication**

Pre-Shared Key

2 In the same screen, create the VPN gateway **BO2** with **wan2**.

**CONFIGURATION > VPN > IPsec VPN > VPN Gateway > Add**

**General Settings**

Enable

VPN Gateway Name:

**IKE Version**

IKEv1

IKEv2

---

**Gateway Settings**

**My Address**

Interface  DHCP client -- 10.214.30.84/255.255.251

Domain Name / IPv4

**Peer Gateway Address**

Static Address ?

Primary

Secondary

Fall back to Primary Peer Gateway when possible

Fall Back Check Interval:  (60-86400 seconds)

Dynamic Address ?

---

**Authentication**

Pre-Shared Key

**3** Go to **CONFIGURATION > VPN > IPsec VPN > VPN Connection > Add** and configure a VPN tunnel for the VPN gateway **BO1**. Select **VPN Tunnel Interface** as the application scenario.

**CONFIGURATION > VPN > IPsec VPN > VPN Connection > Add**

**General Settings**

Enable

Connection Name:

Advance

---

**VPN Gateway**

Application Scenario

Site-to-site

Site-to-site with Dynamic Peer

Remote Access (Server Role)

Remote Access (Client Role)

Vpn Tunnel Interface

VPN Gateway:  wan1 10.214.30.106, 0.0.0.0

---

**Phase 2 Setting**

SA Life Time:  (180 - 3000000 Seconds)

- 4 In the same screen, create a VPN tunnel for the VPN gateway **BO2**.  
Select **VPN tunnel Interface** as the application scenario.

**CONFIGURATION > VPN > IPSec VPN > VPN Connection > Add**

The screenshot shows the configuration page for a new VPN connection. It is divided into three main sections: General Settings, VPN Gateway, and Phase 2 Setting. In the General Settings section, the 'Enable' checkbox is checked, and the 'Connection Name' is set to 'BO2'. The 'Advance' checkbox is unchecked. In the VPN Gateway section, the 'Application Scenario' is set to 'Vpn Tunnel Interface', which is highlighted with a red box. Below this, the 'VPN Gateway' dropdown is set to 'BO2', also highlighted with a red box. The interface name 'wan2' and IP address '10.214.30.107, 0.0.0.0' are visible. In the Phase 2 Setting section, the 'SA Life Time' is set to 86400 seconds, with a range of (180 - 3000000 Seconds) indicated.

- 5 Go to **CONFIGURATION > Network > Interface > VTI > Add** to create a VTI for the VPN tunnel **BO1**. Be aware that the IP address of this VTI must be in the same subnet as **vti1** on **USG1**.

In this example, the IP address and subnet mask of **vti1** on **USG1** is **10.10.10.10** and **255.255.255.0** respectively. The IP address of **vti1** on **USG2** must be in the subnet of **10.10.10.0/24**. Enable the connectivity check. Enter the IP address of **vti1**, which is configured on **USG1**.

**CONFIGURATION > Network > Interface > VTI > Add**

General Settings	
<input checked="" type="checkbox"/> Enable	
Interface Properties	
Interface Name:	<input type="text" value="vti1"/>
Zone:	<input type="text" value="IPSec_VPN"/> ⓘ
vpn-rule:	<input type="text" value="BO1"/> ⓘ
IP Address Assignment	
IP Address:	<input type="text" value="10.10.10.20"/>
Subnet Mask:	<input type="text" value="255.255.255.0"/>
Metric:	<input type="text" value="0"/> (0-15)

**CONFIGURATION > Network > Interface > VTI > vti1 > Connectivity Check**

Connectivity Check	
<input checked="" type="checkbox"/> Enable Connectivity Check	
Check Method:	<input type="text" value="icmp"/>
Check Period:	<input type="text" value="30"/> (5-600 seconds)
Check Timeout:	<input type="text" value="5"/> (1-10 seconds)
Check Fail Tolerance:	<input type="text" value="5"/> (1-10)
Check this address:	<input type="text" value="10.10.10.10"/>

6 In the same screen, create a VTI for the VPN tunnel **BO2**. Be aware that the IP address of this VTI must be in the same subnet as **vti2** on **USG1**. In this example, the IP address and subnet mask of **vti2** on **USG1** is **10.10.11.10** and **255.255.255.0** respectively. The IP address of **vti2** on **USG2** must be in the subnet of **10.10.11.0/24**. Enable the connectivity check. Enter the IP address of **vti2**, which is configured on **USG1**.

**CONFIGURATION > Network > Interface > VTI > Add**

**General Settings**

Enable

**Interface Properties**

Interface Name:

Zone:  ⓘ

vpn-rule:  ⓘ

**IP Address Assignment**

IP Address:

Subnet Mask:

Metric:  (0-15)

**CONFIGURATION > Network > Interface > VTI > vti1 > Connectivity Check**

**Connectivity Check**

Enable Connectivity Check

Check Method:

Check Period:  (5-600 seconds)

Check Timeout:  (1-10 seconds)

Check Fail Tolerance:  (1-10)

Check this address:

- Go to **CONFIGURATION > Network > Interface > Trunk > User Configuration > Add** to create a new trunk. Add **vti1** and **vti2** to the new trunk.

**CONFIGURATION > Network > Interface > Trunk > User Configuration > Add**

Name:

Load Balancing Algorithm:

Load Balancing Index(es):

#	Member	Mode	Egress Bandwidth
1	vti1	Active	1048576 kbps
2	vti2	Active	1048576 kbps

Page 0 of 0 Show 50 items No data to display

**8** Go to **CONFIGURATION > Network > Routing > Policy Route > Add** to configure a policy route.

Source Address: LAN1\_SUBNET (192.168.11.0/24)

Destination Address: HQ\_subnet (192.168.1.0/24)

Next-Hop: BO\_vti\_trunk

SNAT: none

**CONFIGURATION > Network > Routing > Policy Route > Add**

Configuration	
<input checked="" type="checkbox"/> Enable	
Description:	<input type="text"/> (Optional)
Criteria	
User:	any
Incoming:	any (Excluding ZyW)
Source Address:	LAN1_SUBNET
Destination Address:	HQ_subnet
DSCP Code:	any
Schedule:	none
Service:	any
Next-Hop	
Type:	Trunk
Trunk:	BO_vti_trunk
DSCP Marking	
DSCP Marking:	preserve
Address Translation	
Source Network Address Translation:	none

**9** Connect the VPN tunnels when the VTIs are ready. Go to **CONFIGURATION > VPN > IPSec VPN > VPN Connection** to connect the VPN tunnels.



**CONFIGURATION > VPN > IPsec VPN > VPN Connection > Connect**

**Configuration**

Enable

Description:  (Optional)

---

**Criteria**

User:

Incoming:

Source Address:

Destination Address:

DSCP Code:

Schedule:

Service:

---

**Next-Hop**

Type:

Trunk:

---

**DSCP Marking**

DSCP Marking:

---

**Address Translation**

Source Network Address Translation:

**10** Go to **CONFIGURATION > Network > Interface > VTI**. You will see that the status of the VTI is up when the corresponding VPN tunnel is established.

**CONFIGURATION > Network > Interface > VTI**

Port Role	Ethernet	PPP	Cellular	Tunnel	VLAN	Bridge	VTI	Trunk	
<b>Configuration</b>									
<span style="font-size: small;">+ Add Edit Remove Activate Inactivate Object References</span>									
#	Status	Name	IP Address						vpn-rule
1	<span style="color: green;">●</span>	vti1	10.10.10.20/24						BO1
2	<span style="color: green;">●</span>	vti2	10.10.11.20/24						BO2
Page 1 of 1 Show 50 items								Displaying 1 - 2 of 2	

## Test the IPsec VPN Tunnel

**1** To test whether or not a tunnel is working, ping from a PC in LAN1 of USG1 to a PC in LAN1 of USG2 and vice versa.

**PC of USG1 (192.168.1.34) > Window 7 > cmd > ping 192.168.11.33**

```
C:\Users>ping 192.168.11.33 -t

Ping 192.168.11.33 <使用 32 位元組的資料>:
回覆自 192.168.11.33: 位元組=32 時間=1ms TTL=125
回覆自 192.168.11.33: 位元組=32 時間=1ms TTL=124
回覆自 192.168.11.33: 位元組=32 時間=1ms TTL=125
回覆自 192.168.11.33: 位元組=32 時間=1ms TTL=124
回覆自 192.168.11.33: 位元組=32 時間=1ms TTL=125
回覆自 192.168.11.33: 位元組=32 時間=1ms TTL=124
回覆自 192.168.11.33: 位元組=32 時間=1ms TTL=125
回覆自 192.168.11.33: 位元組=32 時間=1ms TTL=124
```

PC of USG2 (192.168.11.33) > Window 7 > cmd > ping 192.168.1.34

```
C:\Users>ping 192.168.1.34 -t

Ping 192.168.1.34 <使用 32 位元組的資料>:
回覆自 192.168.1.34: 位元組=32 時間=1ms TTL=124
回覆自 192.168.1.34: 位元組=32 時間=1ms TTL=125
回覆自 192.168.1.34: 位元組=32 時間=1ms TTL=124
回覆自 192.168.1.34: 位元組=32 時間=1ms TTL=125
回覆自 192.168.1.34: 位元組=32 時間=1ms TTL=124
回覆自 192.168.1.34: 位元組=32 時間=1ms TTL=125
回覆自 192.168.1.34: 位元組=32 時間=1ms TTL=124
回覆自 192.168.1.34: 位元組=32 時間=1ms TTL=125
```

2 To test whether or not VPN failover is working, unplug wan1 of USG1. Then ping from a PC in LAN1 of USG1 to a PC in LAN1 of USG2 and vice versa.

Check the VPN status of the USG1 in the MONITOR > VPN Monitor > IPsec screen.

#	Serial Nu...	System N...	Name	Policy	My Address	Secure Gate...	Up Time	Timeout	Inbound[...	Outbound...
1	S162L44290	VPN100	HQ2	0.0.0.0/1<->0.0.0.0/1	10.214.30.107	P: 10.214.30.84	562	72878	205(11070...	285(17100...

PC of USG1 (192.168.1.34) > Window 7 > cmd > ping 192.168.11.33

```
C:\Users>ping 192.168.11.33 -t

Ping 192.168.11.33 <使用 32 位元組的資料>:
回覆自 192.168.11.33: 位元組=32 時間=1ms TTL=125
回覆自 192.168.11.33: 位元組=32 時間=1ms TTL=124
回覆自 192.168.11.33: 位元組=32 時間=1ms TTL=125
回覆自 192.168.11.33: 位元組=32 時間=1ms TTL=124
回覆自 192.168.11.33: 位元組=32 時間=1ms TTL=125
回覆自 192.168.11.33: 位元組=32 時間=1ms TTL=124
回覆自 192.168.11.33: 位元組=32 時間=1ms TTL=125
回覆自 192.168.11.33: 位元組=32 時間=1ms TTL=124
```

Check the VPN status of the USG2 in the **MONITOR > VPN Monitor > IPSec** screen.

#	Serial Nu...	System N...	Name	Policy	My Address	Secure Gate...	Up Time	Timeout	Inbound[...	Outboun...
1	S162L44290	VPN100	HQ2	0.0.0.0/1<>0.0...	10.214.30.107	P: 10.214.30.84	562	72878	205(11070...	285(17100...

PC of USG2 (192.168.11.33) > Window 7 > cmd > ping 192.168.1.34

```
C:\Users>ping 192.168.1.34 -t

Ping 192.168.1.34 <使用 32 位元組的資料>:
回覆自 192.168.1.34: 位元組=32 時間=1ms TTL=124
回覆自 192.168.1.34: 位元組=32 時間=1ms TTL=125
回覆自 192.168.1.34: 位元組=32 時間=1ms TTL=124
回覆自 192.168.1.34: 位元組=32 時間=1ms TTL=125
回覆自 192.168.1.34: 位元組=32 時間=1ms TTL=124
回覆自 192.168.1.34: 位元組=32 時間=1ms TTL=125
回覆自 192.168.1.34: 位元組=32 時間=1ms TTL=124
回覆自 192.168.1.34: 位元組=32 時間=1ms TTL=125
```

## What Can Go Wrong?

- 1 If you see below [info] or [error] log message, please check ZyWALL/USG Phase 1 Settings. Both ZyWALL/USG at the HQ and Branch sites must use the same Pre-Shared Key, Encryption, Authentication method, DH key group and ID Type to establish the IKE SA.

### MONITOR > Log

Priority	Category	Message	Note
Info	IKE	[COOKIE] Invalid cookie, no sa found	IKE_LOG
Priority	Category	Message	Note
Info	IKE	Recv:[NOTIFY:NO_PROPOSAL_CHOSEN]	IKE_LOG
Info	IKE	[SA] : Tunnel [HQ1] Phase 1 proposal mismatch	IKE_LOG

- 2 If you see that Phase 1 IKE SA process done but still get below [info] log message, please check ZyWALL/USG Phase 2 Settings. Both ZyWALL/USG at the HQ and Branch sites must use the same Protocol, Encapsulation, Encryption, Authentication method and PFS to establish the IKE SA.

## MONITOR > Log

Priority	Cate...	Message	Note
info	IKE	Recv:[HASH][NOTIFY:NO_PROPOSAL_CHOSEN]	IKE_LOG
info	IKE	Send:[HASH][SA][NONCE][ID][ID]	IKE_LOG
info	IKE	Send:[HASH][NOTIFY:NO_PROPOSAL_CHOSEN]	IKE_LOG
info	IKE	[SA] : No proposal chosen	IKE_LOG
info	IKE	[SA] : Tunnel [BO1] Phase 2 proposal mismatch	IKE_LOG
info	IKE	Recv:[HASH][SA][NONCE][ID][ID]	IKE_LOG
info	IKE	Phase 1 IKE SA process done	IKE_LOG

- 3 Make sure the both ZyWALL/USG at the HQ and Branch sites security policies allow IPSec VPN traffic. IKE uses UDP port 500, AH uses IP protocol 51, and ESP uses IP protocol 50.
- 4 Default NAT traversal is enable on ZyWALL/USG, please make sure the remote IPSec device must also have NAT traversal enabled.
- 5 Make sure the both ZyWALL/USG at the HQ and Branch sites use static IP address because VPN Tunnel Interface does not support dynamic peer.
- 6 Make sure policy routes are configured to control traffic between the subnet of HQ and Branch through VTI.
- 7 Make sure that the IP address of VTI at the Branch must be in the same subnet as vti1 on HQ. For example, the IP address and subnet mask of vti1 on HQ is 10.10.10.10 and 255.255.255.0 respectively. The IP address of vti1 on the Branch must be in the subnet of 10.10.10.0/24; the IP address and subnet mask of vti2 on HQ is 10.10.11.10 and 255.255.255.0 respectively. The IP address of vti2 on the Branch must be in the subnet of 10.10.10.0/24, and so on.

## How to configure the USG when using a Cloud Based SIP system

This example shows how to configure USG when there is a Cloud Based SIP system. The IP phones are more and more popular nowadays. USG supports the scenario as IP phones located in LAN and connect to internet to register the SIP server.

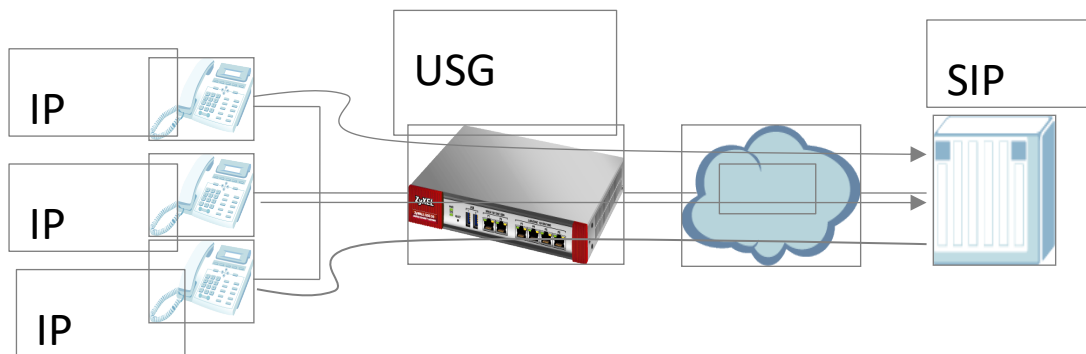

SIP Phone connects to SIP server via USG.



Note: All network IP addresses and subnet masks are used as examples in this article. Please replace them with your actual network IP addresses and subnet masks. This example was tested using USG210 (Firmware Version: ZLD 4.25).

## Set Up the SIP ALG

Go to **CONFIGURATION > Network > ALG**, and check **“Enable SIP ALG”**. Also, check the **“Enable SIP Transformations”** if the SIP content which is needed to be transform. Then click **“Apply”**.

### CONFIGURATION > Network > ALG

The screenshot shows the configuration page for SIP Settings. The page has a blue header with the text 'ALG'. Below the header, the title 'SIP Settings' is displayed. The settings are as follows:

- Enable SIP ALG
  - Enable SIP Transformations
  - Enable Configure SIP Inactivity Timeout
    - SIP Media Inactivity Timeout :  (seconds)
    - SIP Signaling Inactivity Timeout :  (seconds)
  - Restrict Peer to Peer Signaling Connection
  - Restrict Peer to Peer Media Connection ⓘ
- SIP Signaling Port :
 

#	Port
1	5060

Direct-media and Direct-signalling are activated after ZLD 4.25. We can use the CLI to show the status. When the two options are yes, it will change the original sip alg behavior.

direct-signalling will expect incoming calls from register only.

direct-media will expect media streams between signalling endpoints only.

## Test result

Connect SIP phone to the USG, and check the register status. Register successfully.

SIP Accounts				
#	Display Name	Registration Server	Status	Registration
1	2436	10.214.30.86	registered	Enable

Check the SIP register status on PBX.

#	Time	Priority	Category	Message
2	2017-07-07 04:20:...	notice	PBX SIP	Extension '2436' registered successfully at 10.214.30.90:5061 with expire time 3276.
3	2017-07-07 04:20:...	notice	PBX SIP	Extension 2436 registered successfully with expire time 3276

## What could go wrong?

SIP phone does not support transform itself, but the "SIP Transformations" does not be checked.

48	5.700826	10.251.30.94	10.251.30.58	SIP	523 Request: REGISTER sip:10.251.30.58
49	5.704336	10.251.30.58	10.251.30.94	SIP	559 Status: 401 unauthorized (0 bindings)
50	5.737000	10.251.30.94	10.251.30.58	SIP	681 Request: REGISTER sip:10.251.30.58
51	5.742023	10.251.30.58	10.251.30.94	SIP	586 Request: NOTIFY sip:2436@192.168.1.33:5060

```

Frame 51: 586 bytes on wire (4688 bits), 586 bytes captured (4688 bits)
Ethernet II, Src: ZyxelCom_33:cf:8e (cc:5d:4e:33:cf:8e), Dst: 5c:f4:ab:f8:fd:54 (5c:f4:ab:f8:fd:54)
Internet Protocol Version 4, Src: 10.251.30.58 (10.251.30.58), Dst: 10.251.30.94 (10.251.30.94)
User Datagram Protocol, Src Port: sip (5060), Dst Port: sip (5060)
  Source port: sip (5060)
  Destination port: sip (5060)
  Length: 552
  Checksum: 0x0571 [validation disabled]
Session Initiation Protocol
  Request-Line: NOTIFY sip:2436@192.168.1.33:5060 SIP/2.0
  Message Header
    Via: SIP/2.0/UDP 10.251.30.58:5060;branch=z9hG4bk10f6cfa3;rport
    Max-Forwards: 70
    From: "TSG" < sip:TSG@10.251.30.58>;tag=as7e8e60ba
    
```

SIP phone will contact with outside as not direct-signalling and direct media, but the default setting on USG is on

## How to block HTTPS websites by Domain Filter without applying SSL Inspection

The Content Filter with HTTPs Domain Filter allows you to block HTTPs websites by category service without SSL-Inspection. The filtering feature is based on more than 50 Managed Categories built in ZyWALL/USG such as pornography, gambling, hacking, etc.

When user makes HTTPS request, the information contains a Server Name Indication

(SNI) extension fields in server FQDN. Using the SNI to query category from Commtouch engine, then take action when it matches the block category in Content Filter profile.

## ZyWALL/USG Domain Filter Example

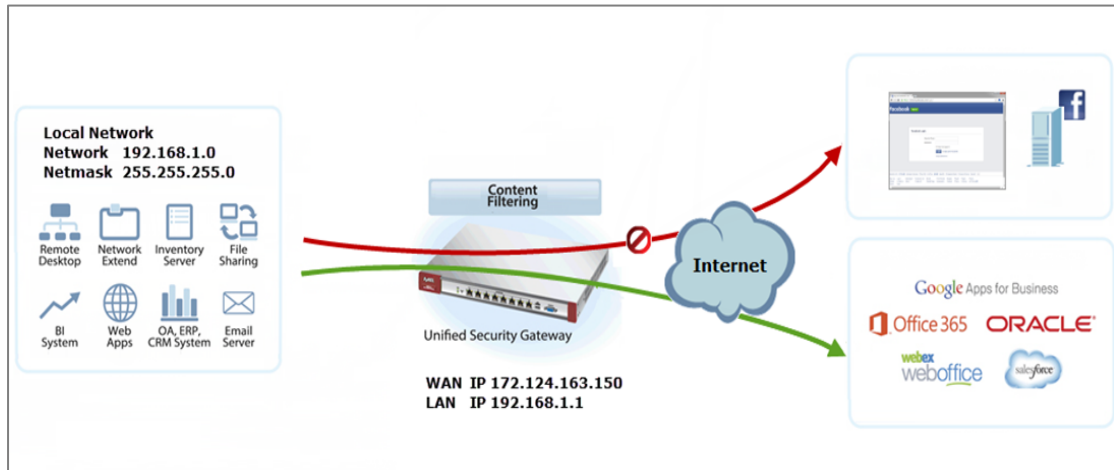

 Note: All network IP addresses and subnet masks are used as examples in this article. Please replace them with your actual network IP addresses and subnet masks. This example was tested using USG310 (Firmware Version: 4.25)

## Set Up the Content Filter on the ZyWALL/USG

Go to **CONFIGURATION > UTM Profile > Content Filter > Profile > General Settings**. Select **Enable HTTPS Domain Filter for HTTPS traffic**.

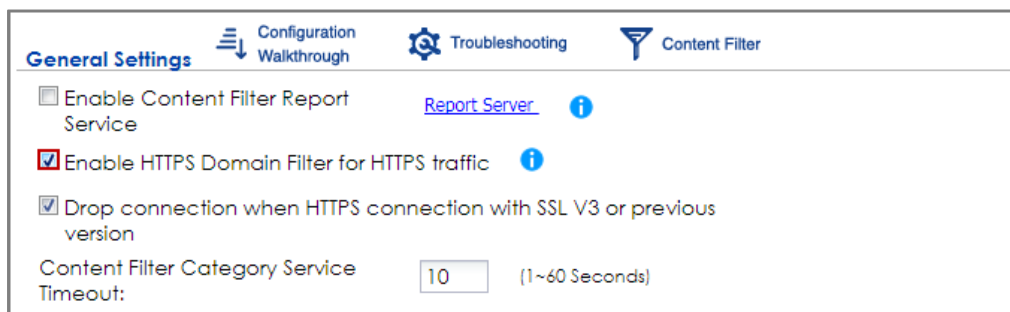

Go to **CONFIGURATION > UTM Profile > Content Filter > Profile Management > Add Filter**



**Profile > Test Web Site Category.** Type URL to test the category and click **Test Against Content Filter Category Server.**

You will see the category recorded in the external content filter server's database for both HTTP and HTTPS Domain you specified.

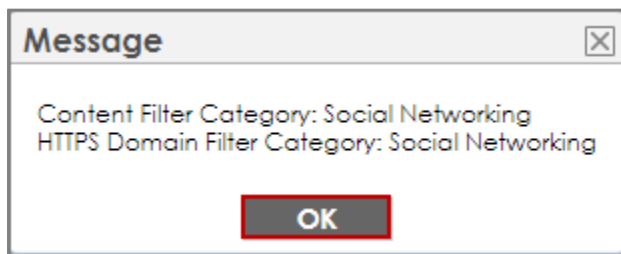

Go to **CONFIGURATION > UTM Profile > Content Filter > Profile Management > Add Filter File > Custom Service.** Configure a **Name** for you to identify the **Content Filter Profile** and select **Enable Content Filter Category Service.** Select **Block** to prevent users from accessing web pages that match the managed categories that you select below. Select **Log** to record attempts to access web pages that match the unsafe categories that you select below.

### General Settings

License Status: Licensed

License Type: Standard

Name: Social\_Net\_Block

Description:  (Optional)

Enable SafeSearch

Enable Content Filter Category Service

Log all web pages

Action for Unsafe Web Pages: Block  Log

Action for Managed Web Pages: Block  Log

Action for Unrated Web Pages: Warn  Log

Action When Category Server Is Unavailable: Warn  Log

Scroll down to the **Managed Categories** section, select categories in this section to control access to specific types of Internet content. You must have the Content Filtering license to filter these categories.

### Managed Categories

<input type="checkbox"/> Advertisements & Pop-Ups	<input type="checkbox"/> Alcohol/Tobacco	<input type="checkbox"/> Arts
<input type="checkbox"/> Business	<input type="checkbox"/> Transportation	<input type="checkbox"/> Chat
<input type="checkbox"/> Forums & Newsgroups	<input type="checkbox"/> Computers & Technology	<input type="checkbox"/> Criminal Activity
<input type="checkbox"/> Dating & Personals	<input type="checkbox"/> Download Sites	<input type="checkbox"/> Education
<input type="checkbox"/> Entertainment	<input type="checkbox"/> Finance	<input type="checkbox"/> Gambling
<input type="checkbox"/> Games	<input type="checkbox"/> Government	<input type="checkbox"/> Hate & Intolerance
<input type="checkbox"/> Health & Medicine	<input type="checkbox"/> Illegal Drugs	<input type="checkbox"/> Job Search
<input type="checkbox"/> Streaming Media & Downloads	<input type="checkbox"/> News	<input type="checkbox"/> Non-profits & NGOs
<input type="checkbox"/> Nudity	<input type="checkbox"/> Personal Sites	<input type="checkbox"/> Politics
<input type="checkbox"/> Pornography/Sexually Explicit	<input type="checkbox"/> Real Estate	<input type="checkbox"/> Religion
<input type="checkbox"/> Restaurants & Dining	<input type="checkbox"/> Search Engines/Portals	<input type="checkbox"/> Shopping
<input checked="" type="checkbox"/> Social Networking	<input type="checkbox"/> Sports	<input type="checkbox"/> Translators
<input type="checkbox"/> Travel	<input type="checkbox"/> Violence	<input type="checkbox"/> Weapons
<input type="checkbox"/> Web-based Email	<input type="checkbox"/> General	<input type="checkbox"/> Leisure & Recreation
<input type="checkbox"/> Cults	<input type="checkbox"/> Fashion & Beauty	<input type="checkbox"/> Greeting Cards
<input type="checkbox"/> Hacking	<input type="checkbox"/> Illegal Software	<input type="checkbox"/> Image Sharing
<input type="checkbox"/> Information Security	<input type="checkbox"/> Instant Messaging	<input type="checkbox"/> Peer to Peer
<input type="checkbox"/> Private IP Addresses	<input type="checkbox"/> School Cheating	<input type="checkbox"/> Sex Education
<input type="checkbox"/> Tasteless	<input type="checkbox"/> Child Abuse Images	

## Set Up the Security Policy on the ZyWALL/USG

Go to **CONFIGURATION > Security Policy > Policy Control**, configure a **Name** for you to identify the **Security Policy** profile. Scroll down to **UTM Profile**, select **Content Filter** and select a profile from the list box (Social\_Net\_Block in this example).

Enable

Name:

Description:  (Optional)

From:

To:

Source:

Destination:

Service:

User:

Schedule:

Action:

Log matched traffic:

**UTM Profile**

Content Filter:  Log:

SSL Inspection:  Log:

## Set Up the System Policy on the ZyWALL/USG

Go to **CONFIGURATION > System > WWW > Show Advanced Settings > Other**, click **Enable Content Filter HTTPS Domain Filter Block/Warn Page**.

**Other**

Enable Content Filter HTTPS Domain Filter Block/Warn Page

Block/Warn Page Port:

## Test the Result

Type <http://www.facebook.com/> or <https://www.facebook.com/> into the browser, the error message occurs.

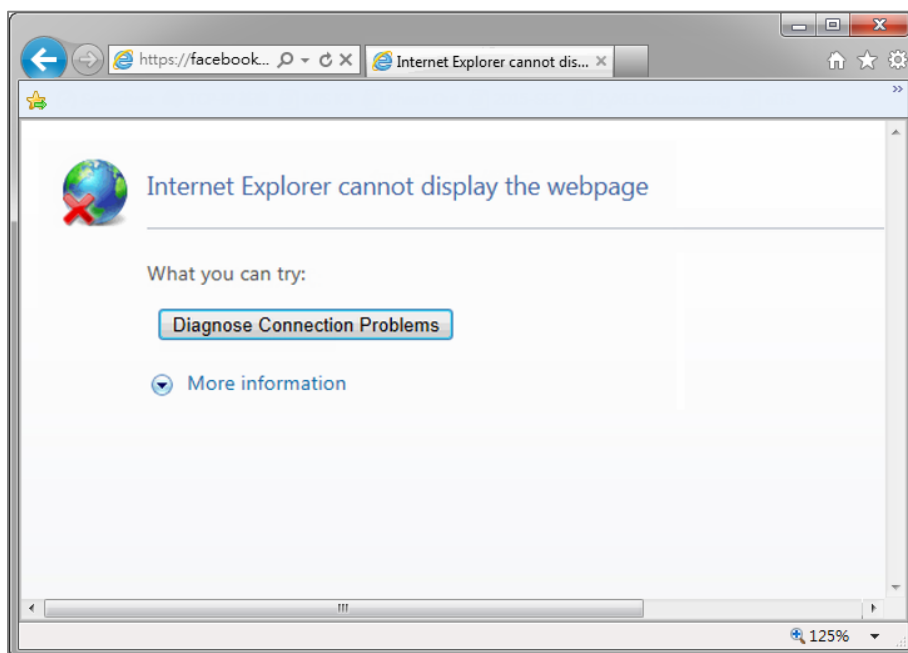
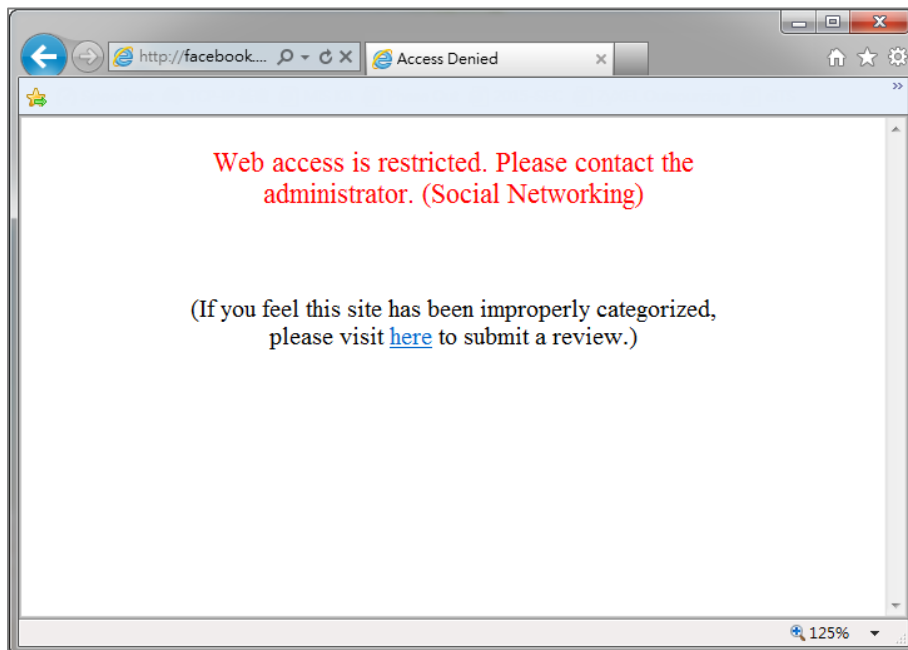

Go to the ZyWALL/USG **Monitor > Log**, you will see [alert] log message such as below. HTTP traffic log matches (Content Filter) and HTTPS traffic log matches (HTTPS Domain Filter) in message field.

## Monitor > Log

#	Time	Priority	Category	Message	Source	Destination	Note
1	2016-03-17 02:22:39	notice	Security Policy Control	Match default rule, DROP [count=2]	10.251.31.91:17500	255.255.255.255:17500	ACCESS BLOCK
2	2016-03-17 02:33:09	alert	Blocked web sites	facebook.com : Social Networking, Rule_id=1 (Content Filter)	192.168.1.33:18424	66.220.158.68:80	WEB BLOCK
3	2016-03-17 02:22:35	alert	Blocked web sites	www.facebook.com : Social Networking, Rule_id=1 (HTTPS Domain Filter)	192.168.1.33:51728	31.13.79.220:443	WEB BLOCK

## How to Configure Content Filter 2.0 with Geo IP Blocking

The Content Filter 2.0 - Geo IP blocking offers identify the country based on IP address, it allows you to block the client accessing to certain country based on organizational policy.

When user makes HTTP or HTTPS request, ZyWALL/USG query IP address from MaxMind database, then take action when it matches the block country in Content Filter profile. If you have a local web site and your primary market is local people, then there is no need to let any other countries index or waste bandwidth on your server.

Also this feature offer an easy and effective way to prevent bogus, bots, brute force hacks, vulnerability scanners, and web crawlers from other countries.

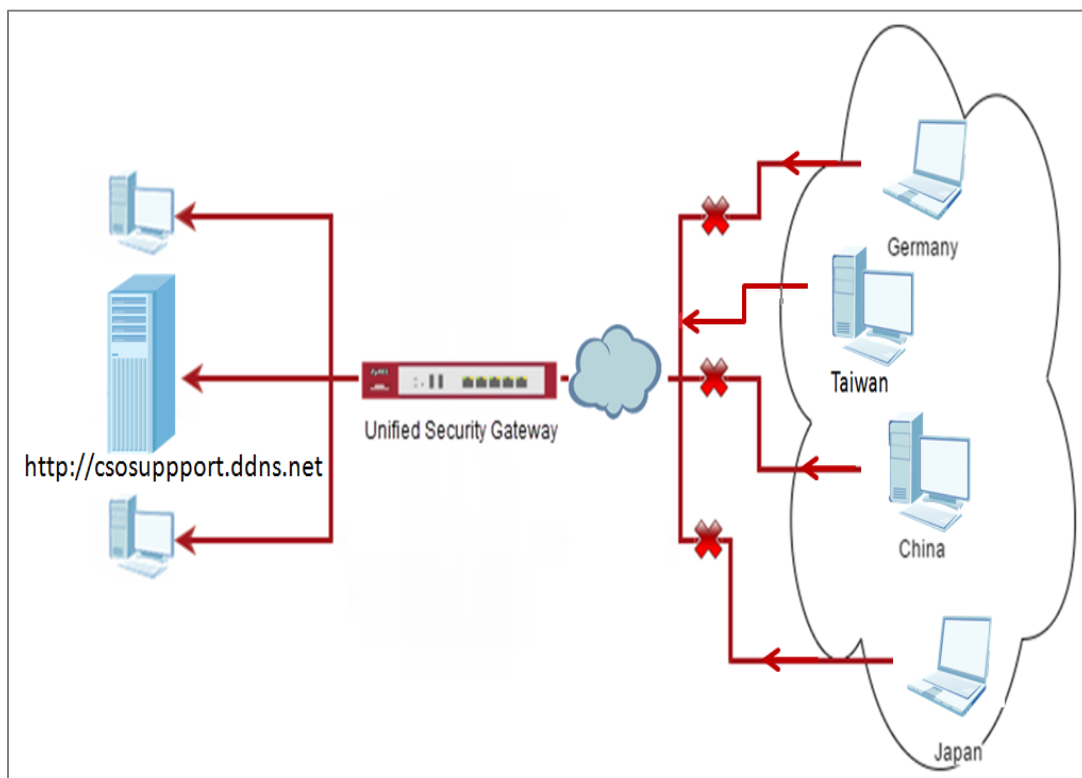

## Set Up the Address Object with Geo IP on the ZyWALL/USG

Go to **CONFIGURATION > Object > Address/Geo IP > Address > Add Address Rule.**

**Edit Address Rule Taiwan**

Name:

Address Type:

Country:

OK Cancel

Go to **CONFIGURATION > Object > Address/Geo IP > Address**, you can see the customized GEOGRAPHY address.

**IPv4 Address Configuration**

Address Address Group Geo IP

#	Name	Type	IPv4 Address
1	wan2	INTERFACE IP	wan2-10.251.30.90
2	LAN2_SUBNET	INTERFACE SUBNET	lan2-192.168.2.0/24
3	LAN1_SUBNET	INTERFACE SUBNET	lan1-192.168.1.0/24
4	DMZ_SUBNET	INTERFACE SUBNET	dmz-192.168.3.0/24
5	Taiwan	GEOGRAPHY	Taiwan-All
6	IP6to4-Relay	HOST	192.88.99.1
7	l2tp_pool	RANGE	192.168.10.10-192.168.10.20
8	RFC1918_3	SUBNET	192.168.0.0/16
9	RFC1918_2	SUBNET	172.16.0.0/12

## Set Up the Security Policy on the ZyWALL/USG

Go to **CONFIGURATION > Security Policy > Policy Control**, configure a **Name** for you to identify the **Security Policy** profile. Set Geo IP traffic from WAN to LAN allow source from local country (geo\_allow\_policy in this example).

The screenshot shows the 'Edit Policy1' configuration window. The 'Enable' checkbox is checked. The 'Name' field contains 'geo\_allow\_policy'. The 'Description' field is empty with '(Optional)' next to it. The 'From' dropdown is set to 'WAN', 'To' to 'LAN1', and 'Source' to 'Taiwan'. The 'Destination' dropdown is set to 'any', 'Service' to 'any', 'User' to 'any', and 'Schedule' to 'none'. The 'Action' dropdown is set to 'allow'. The 'Log matched traffic' dropdown is set to 'log'. Red boxes highlight the 'From', 'To', 'Source', and 'Action' fields.

Go to **CONFIGURATION > Security Policy > Policy Control**, configure a **Name** for you to identify the **Security Policy** profile. Set traffic from WAN to LAN deny (geo\_block\_policy in this example).

The screenshot shows the 'Add corresponding' configuration window. The 'Enable' checkbox is checked. The 'Name' field contains 'geo\_block\_policy'. The 'Description' field is empty with '(Optional)' next to it. The 'From' dropdown is set to 'WAN', 'To' to 'LAN1', 'Source' to 'any', 'Destination' to 'any', 'Service' to 'any', 'User' to 'any', and 'Schedule' to 'none'. The 'Action' dropdown is set to 'deny'. The 'Log denied traffic' dropdown is set to 'no'. Red boxes highlight the 'From', 'To', and 'Action' fields.

## Test the Result



Type <http://csosupport.ddns.net/> into the browser, and the http can be reached.

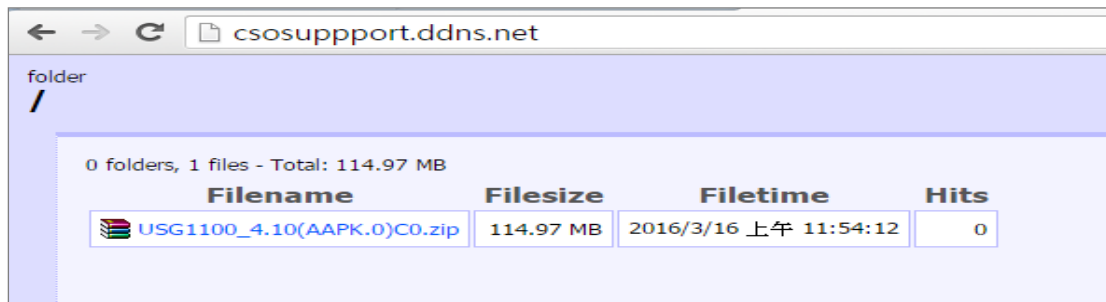

Go to the ZyWALL/USG **Monitor > Log**, you will see [notice] log message such as below. Traffic matches Geo IP policy will be blocked and shows in message field.

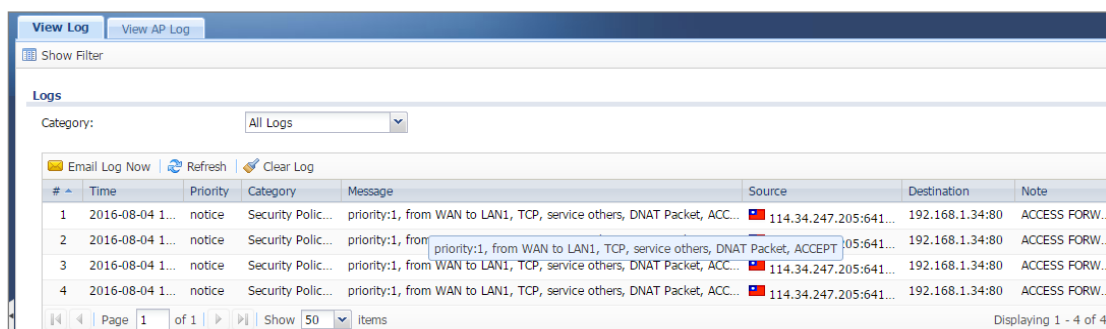

## What Could Go Wrong?

1. The Security Policy configured wrong. The traffic cannot access the LAN server.

#	Time	Priority	Category	Message	Source	Destination	Note
5	2016-08-19 1...	alert	Security Polic...	Match default rule, DNAT Packet, DROP [count=3]	114.34.247.205:...	192.168.1.34:80	ACCESS BLOCK
6	2016-08-19 1...	alert	Security Polic...	Match default rule, DNAT Packet, DROP [count=3]	114.34.247.205:...	192.168.1.34:80	ACCESS BLOCK

2. The Content-Filter service is expired. Since Geo-IP server is bind with Content-Filter license, there must be available date for Content-Filter service.

## **How to Configure Content Filter 2.0 with HTTPs Domain Filter**

### **Application Scenario**

The Content Filter with HTTPs Domain Filter allows you to block HTTPs websites by category service without SSL-Inspection. The filtering feature is based on 64 categories built in ZyWALL/USG such as pornography, gambling, hacking, etc.

When user makes HTTPS request, the information contains a Server Name Indication (SNI) extension fields in server FQDN. Using the SNI to query category from local cache then cloud database, then take action when it matches the block category in Content Filter profile.

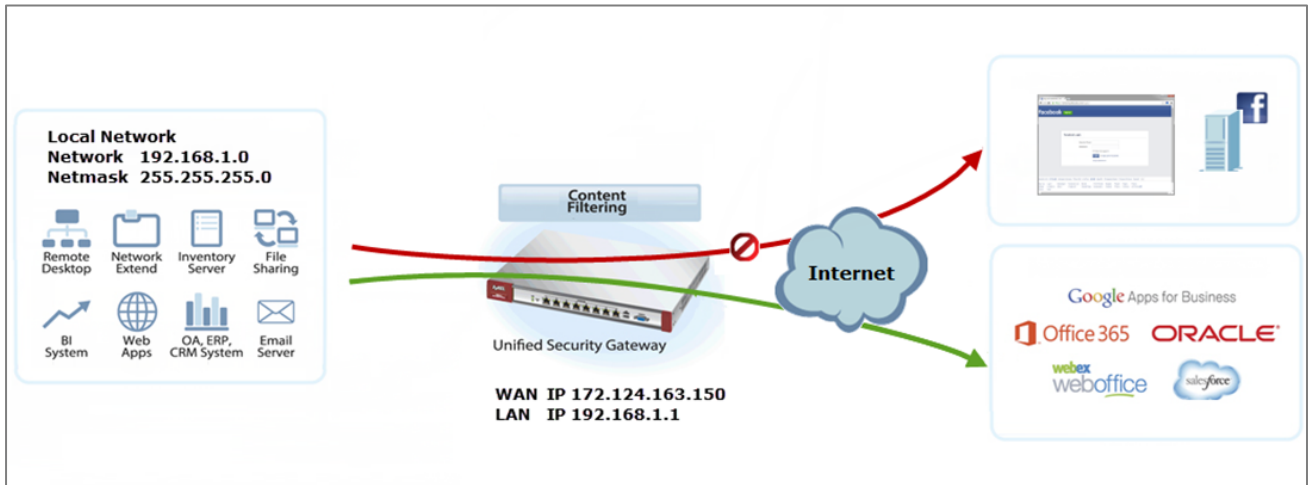

## Set Up the Content Filter on the ZyWALL/USG

Go to **CONFIGURATION > UTM Profile > Content Filter > Profile > General Settings**. Select **Enable HTTPS Domain Filter for HTTPS traffic**.

<b>General Settings</b>	Configuration Walkthrough	Troubleshooting	Content Filter
<input type="checkbox"/> Enable Content Filter Report Service	<a href="#">Report Server</a>	<a href="#">i</a>	
<input checked="" type="checkbox"/> Enable HTTPS Domain Filter for HTTPS traffic		<a href="#">i</a>	
<input checked="" type="checkbox"/> Drop connection when HTTPS connection with SSL V3 or previous version			
Content Filter Category Service Timeout:	<input type="text" value="10"/>	(1~60 Seconds)	

Go to **CONFIGURATION > UTM Profile > Content Filter > Profile Management > Add Filter Profile > Test Web Site Category**. Type URL to test the category and click **Test Against Content Filter Category Server**.

<b>Test Web Site Category</b>	
URL to test:	<input type="text" value="https://facebook.com"/>
	<a href="#">Test Against Content Filter Category Server</a>
<a href="#">If you think the category is incorrect, click this link to submit a request to review it.</a>	

You will see the category recorded in the external content filter server's database for both HTTP and HTTPS Domain you specified.

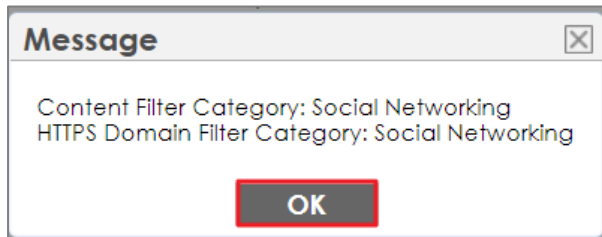

Go to **CONFIGURATION > UTM Profile > Content Filter > Profile Management > Add Filter File > Custom Service**. Configure a **Name** for you to identify the **Content Filter Profile** and select **Enable Content Filter Category Service**. Select **Block** to prevent users from accessing web pages that match the managed categories that you select below. Select **Log** to record attempts to access web pages that match the unsafe categories that you select below.

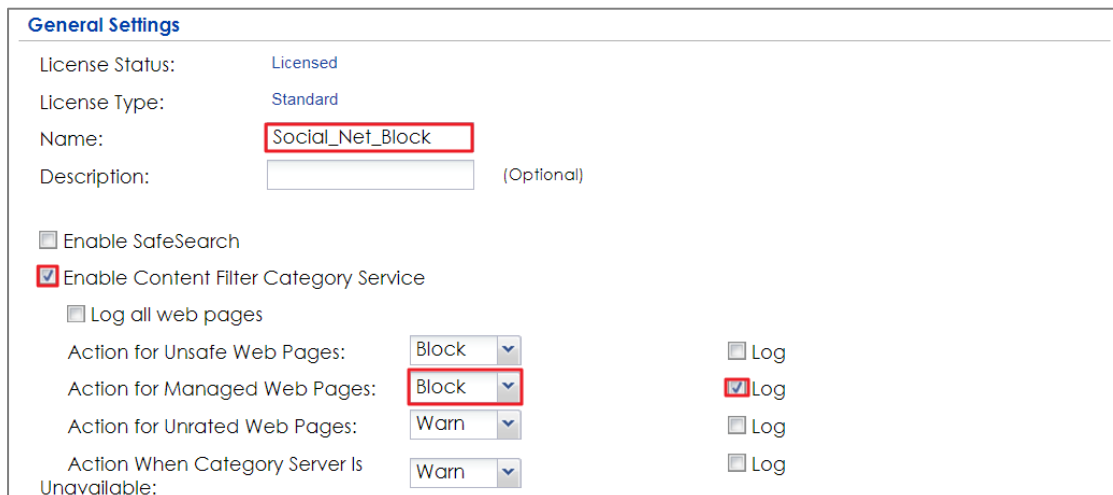

Scroll down to the **Managed Categories** section, select categories in this section to control access to specific types of Internet content. You must have the Content Filtering license to filter these categories.

Category Service	Custom Service	
<input type="checkbox"/> Advertisements & Pop-Ups	<input type="checkbox"/> Alcohol/Tobacco	<input type="checkbox"/> Arts
<input type="checkbox"/> Business	<input type="checkbox"/> Transportation	<input type="checkbox"/> Chat
<input type="checkbox"/> Forums & Newsgroups	<input type="checkbox"/> Computers & Technology	<input type="checkbox"/> Criminal Activity
<input type="checkbox"/> Dating & Personals	<input type="checkbox"/> Download Sites	<input type="checkbox"/> Education
<input type="checkbox"/> Entertainment	<input type="checkbox"/> Finance	<input type="checkbox"/> Gambling
<input type="checkbox"/> Games	<input type="checkbox"/> Government	<input type="checkbox"/> Hate & Intolerance
<input type="checkbox"/> Health & Medicine	<input type="checkbox"/> Illegal Drugs	<input type="checkbox"/> Job Search
<input type="checkbox"/> Streaming Media & Downloads	<input type="checkbox"/> News	<input type="checkbox"/> Non-profits & NGOs
<input type="checkbox"/> Nudity	<input type="checkbox"/> Personal Sites	<input type="checkbox"/> Politics
<input type="checkbox"/> Pornography/Sexually Explicit	<input type="checkbox"/> Real Estate	<input type="checkbox"/> Religion
<input type="checkbox"/> Restaurants & Dining	<input type="checkbox"/> Search Engines/Portals	<input type="checkbox"/> Shopping
<input checked="" type="checkbox"/> Social Networking	<input type="checkbox"/> Sports	<input type="checkbox"/> Translators
<input type="checkbox"/> Travel	<input type="checkbox"/> Violence	<input type="checkbox"/> Weapons
<input type="checkbox"/> Web-based Email	<input type="checkbox"/> General	<input type="checkbox"/> Leisure & Recreation
<input type="checkbox"/> Cults	<input type="checkbox"/> Fashion & Beauty	<input type="checkbox"/> Greeting Cards
<input type="checkbox"/> Hacking	<input type="checkbox"/> Illegal Software	<input type="checkbox"/> Image Sharing
<input type="checkbox"/> Information Security	<input type="checkbox"/> Instant Messaging	<input type="checkbox"/> Peer to Peer

## Set Up the Security Policy on the ZyWALL/USG

Go to **CONFIGURATION > Security Policy > Policy Control**, configure a **Name** for you to identify the **Security Policy** profile. Scroll down to **UTM Profile**, select **Content Filter** and select a profile from the list box (Social\_Net\_Block in this example).

Create new Object ▼

Enable

Name:

Description:  (Optional)

From:

To:

Source:

Destination:

Service:

User:

Schedule:

Action:

Log matched traffic:

**UTM Profile**

Content Filter:  Log:

## Set Up the System Policy on the ZyWALL/USG

Go to **CONFIGURATION > System > WWW > Show Advanced Settings > Other**, click **Enable Content Filter HTTPS Domain Filter Block/Warn Page**.

**Other**

Enable Content Filter HTTPS Domain Filter Block/Warn Page

Block/Warn Page Port:

## Test the Result

Type <http://www.facebook.com/> or <https://www.facebook.com/> into the browser, the error message occurs.

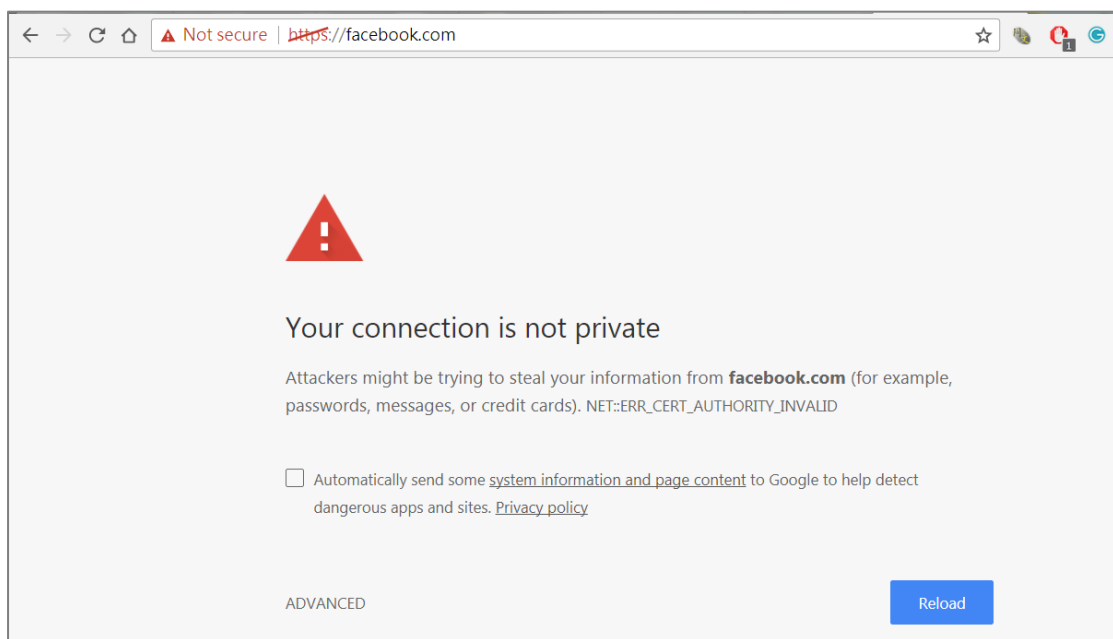

Go to the ZyWALL/USG **Monitor > Log**, you will see [alert] log message such as below. HTTP traffic log matches (Content Filter) and HTTPS traffic log matches (HTTPS Domain Filter) in message field.

### Monitor > Log

#	Time	Pri...	Category	Message	Source	Desti...	Note
28	20...	alert	Blocked w...	facebook.com : Social Networking, Rule_id=1, SSI=N (HTTPS Domain...	192.168.2.3...	31...	WEB BLOCK
29	20...	alert	Blocked w...	facebook.com : Social Networking, Rule_id=1, SSI=N (HTTPS Domain...	192.168.2.3...	31...	WEB BLOCK
30	20...	alert	Blocked w...	facebook.com : Social Networking, Rule_id=1, SSI=N (HTTPS Domain...	192.168.2.3...	31...	WEB BLOCK

## What Could Wrong?

1. "Enable HTTPS Domain Filter for HTTPS traffic" is not checked.

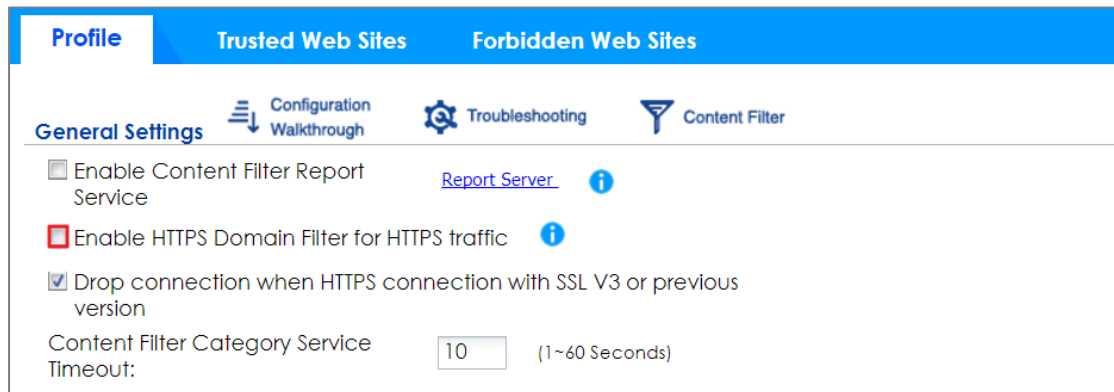

HTTPs traffic will pass.

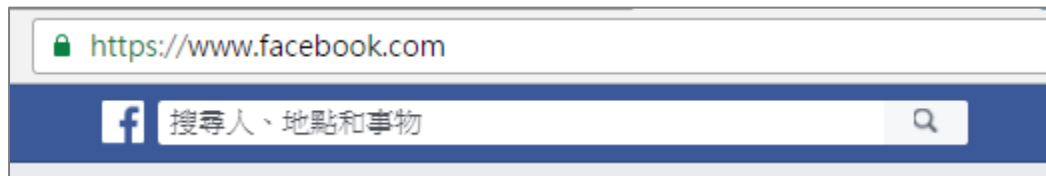

## How to block the client accessing to certain country using Geo IP and Content Filter

The Content Filter with Geo IP offers identify the country based on IP address, it allows you to block the client accessing to certain country based on organizational policy.

When user makes HTTP or HTTPS request, ZyWALL/USG query IP address from MaxMind database, then take action when it matches the block country in Content Filter profile.

ZyWALL/USG Geo IP Example



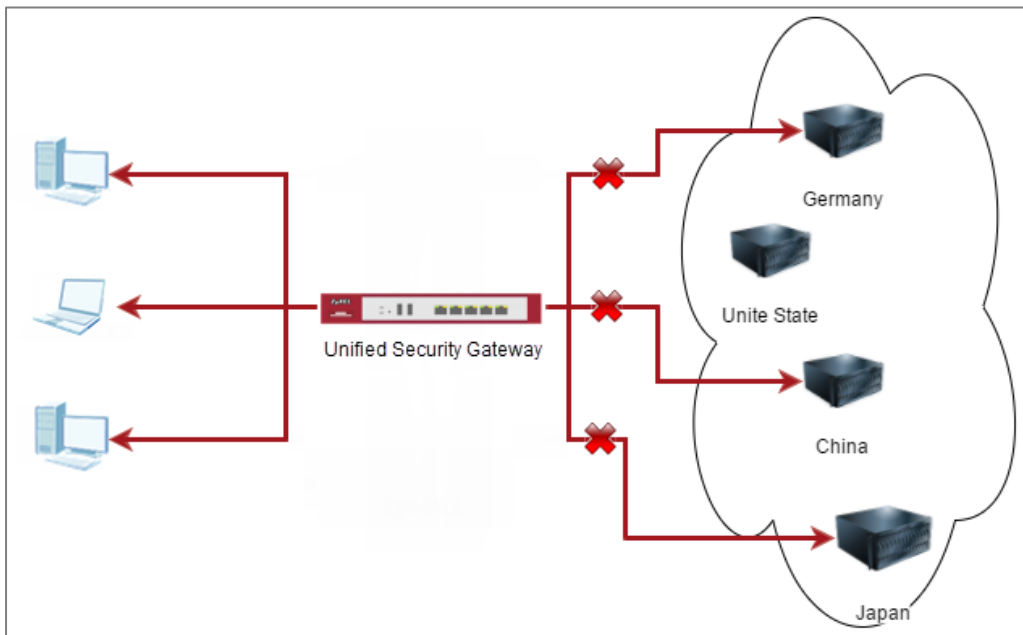

 Note: All network IP addresses and subnet masks are used as examples in this article. Please replace them with your actual network IP addresses and subnet masks. This example was tested using USG310 (Firmware Version: 4.25)

## Check Geo IP License Status on the ZyWALL/USG

Go to **CONFIGURATION > Licensing > Registration > Service**, the **Geo IP Service** should be **Licensed** to configure this feature.

#	Service	Status	Service Type	Expiration ...	Count	Action
1	Content Filter 2.0	Licensed	Standard	2018-7-6	N/A	<a href="#">Renew</a>
2	SSL VPN Service	Licensed	Standard		60	<a href="#">Buy</a>
3	Managed AP Service	Default	Standard		4	<a href="#">Buy</a>
4	Zymesh Service	Not Licens...			N/A	
5	Concurrent Device Upgr...	Default	Standard		200	<a href="#">Buy</a>
6	Device HA Pro	Not Licens...			N/A	<a href="#">Buy</a>
7	Firmware Upgrade Service	Not Licens...			N/A	
8	SecuReporter	Not Licens...			N/A	<a href="#">Buy</a>

## Set Up the Address Object with Geo IP on the ZyWALL/USG

Go to **CONFIGURATION > Object > Address/Geo IP > Address > Add Address Rule.**

**+ Add Address Rule** ? X

Name:

Address Type:

Country:

Go to **CONFIGURATION > Object > Address/Geo IP > Address**, you can see the customized GEOGRAPHY address.

#	Name	Type	IPv4 Address	Refer...
1	DMZ_SUBNET	INTERFACE SUBNET	ge6-192.168.3.0/24	0
2	IP6to4-Relay	HOST	192.88.99.1	0
3	LAN_SUBNET_GE4	INTERFACE SUBNET	ge4-192.168.1.0/24	0
4	LAN_SUBNET_GE5	INTERFACE SUBNET	ge5-192.168.2.0/24	0
5	RFC1918_1	SUBNET	10.0.0.0/8	1
6	RFC1918_2	SUBNET	172.16.0.0/12	1
7	RFC1918_3	SUBNET	192.168.0.0/16	1
8	Taiwan	GEOGRAPHY	Taiwan-All	1
9	geo1	GEOGRAPHY	China-All	0
10	geo2	GEOGRAPHY	Germany-All	0

Go to **CONFIGURATION > Object > Address/Geo IP > Address Group > Add Address Group Rule**, add all customized GEOGRAPHY address into the same **Member** object.

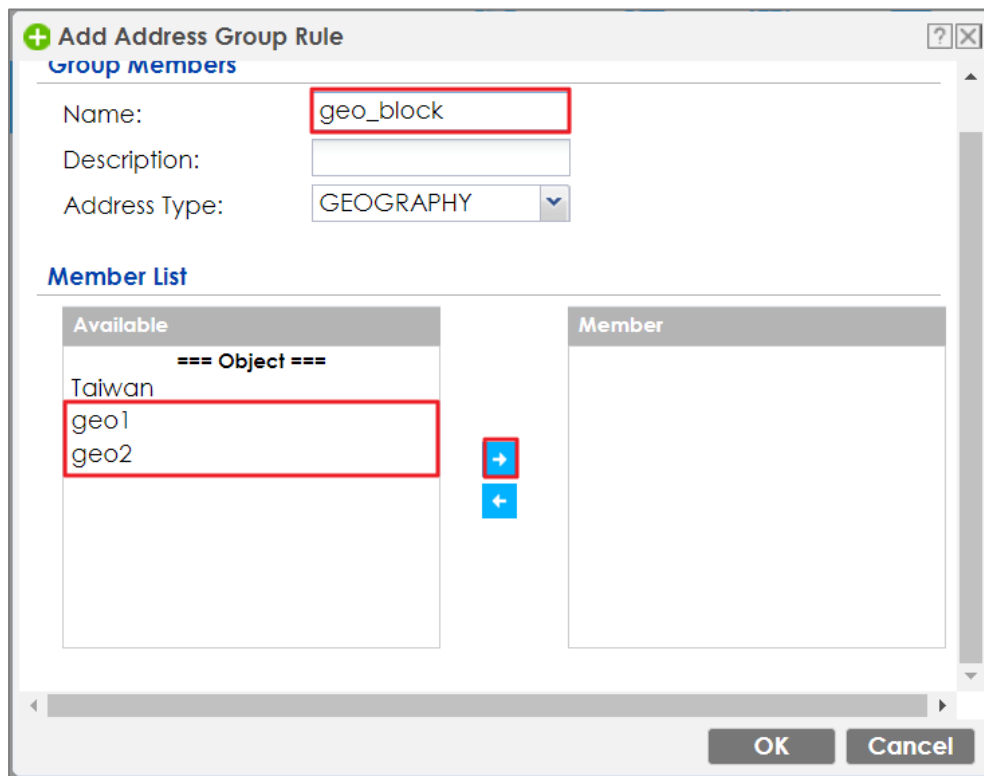

## Set Up the Security Policy on the ZyWALL/USG

Go to **CONFIGURATION > Security Policy > Policy Control**, configure a **Name** for you to identify the **Security Policy** profile. Set deny Geo IP traffic from LAN to WAN (geo\_block\_policy in this example).

**+ Add corresponding** [?] [X]

Create new Object ▾

Enable

Name:

Description:  (Optional)

From:  ▾

To:  ▾

Source:  ▾

Destination:  ▾

Service:  ▾

User:  ▾

Schedule:  ▾

Action:  ▾

Log denied traffic:  ▾

OK Cancel

## Test the Result

Type <http://www.pku.edu.cn/> or <https://www.rwth-aachen.de/> into the browser, sites can't be reached.

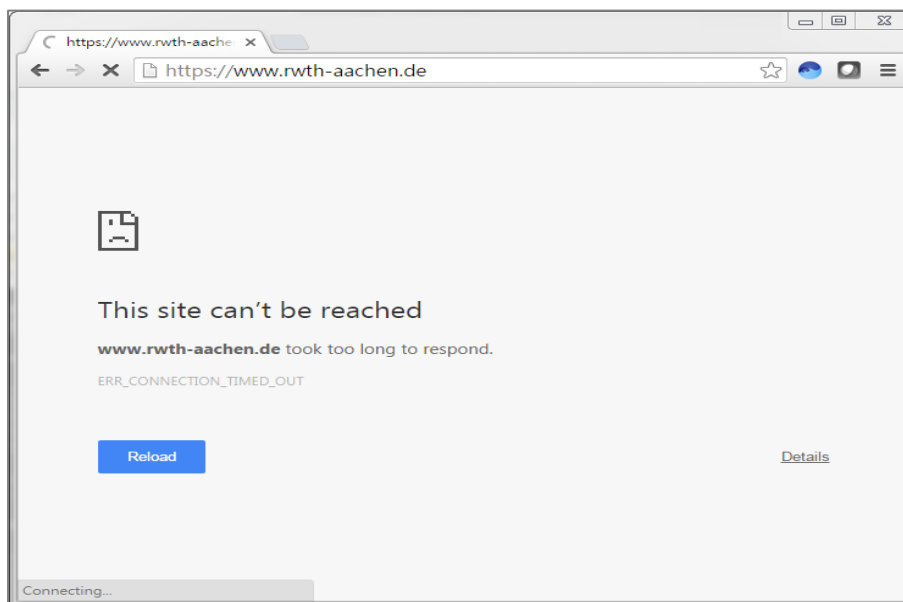
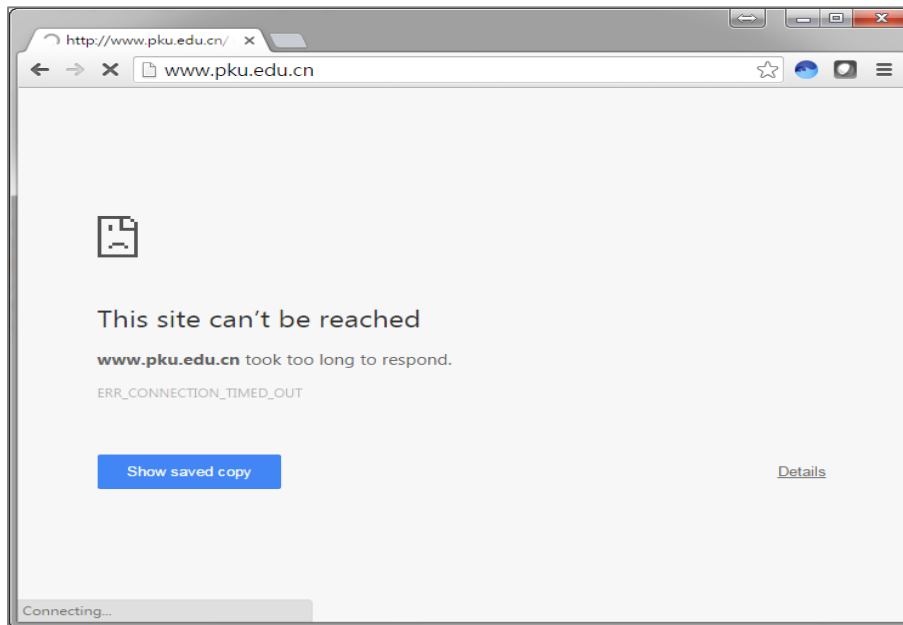

Go to the ZyWALL/USG **Monitor > Log**, you will see [notice] log message such as below. Traffic matches Geo IP policy will be blocked and shows in message field.

**Logs**

Category:

#	Time	Priority	Category	Message	Source	Destination	Note
1	2...	al...	Security P...	priority:1, from LAN2 to WAN, TCP, service others, DROP [count=2]	192.168.2.3...	61...	ACCESS BLOCK
2	2...	al...	Security P...	priority:1, from LAN2 to WAN, TCP, service others, DROP [count=2]	192.168.2.3...	115...	ACCESS BLOCK
3	2...	al...	Security P...	priority:1, from LAN2 to WAN, TCP, service others, DROP [count=2]	192.168.2.3...	61...	ACCESS BLOCK
4	2...	al...	Security P...	priority:1, from LAN2 to WAN, TCP, service others, DROP [count=2]	192.168.2.3...	115...	ACCESS BLOCK
5	2...	al...	Security P...	priority:1, from LAN2 to WAN, TCP, service others, DROP [count=3]	192.168.2.3...	137...	ACCESS BLOCK
6	2...	al...	Security P...	priority:1, from LAN2 to WAN, TCP, service others, DROP [count=3]	192.168.2.3...	137...	ACCESS BLOCK
7	2...	al...	Security P...	Match default rule, DROP [count=6]	10.214.30.3...	10.214...	ACCESS BLOCK
8	2...	al...	Security P...	priority:1, from LAN2 to WAN, TCP, service others, DROP [count=3]	192.168.2.3...	61...	ACCESS BLOCK
9	2...	al...	Security P...	priority:1, from LAN2 to WAN, TCP, service others, DROP [count=3]	192.168.2.3...	61...	ACCESS BLOCK
10	2...	al...	Security P...	priority:1, from LAN2 to WAN, TCP, service others, DROP [count=3]	192.168.2.3...	61...	ACCESS BLOCK
11	2...	al...	Security P...	priority:1, from LAN2 to WAN, TCP, service others, DROP [count=3]	192.168.2.3...	61...	ACCESS BLOCK
12	2...	al...	Security P...	priority:1, from LAN2 to WAN, TCP, service others, DROP [count=3]	192.168.2.3...	61...	ACCESS BLOCK
13	2...	al...	Security P...	priority:1, from LAN2 to WAN, TCP, service others, DROP [count=3]	192.168.2.3...	61...	ACCESS BLOCK
14	2...	al...	Security P...	priority:1, from LAN2 to WAN, TCP, service others, DROP [count=3]	192.168.2.3...	162...	ACCESS BLOCK
15	2...	al...	Security P...	priority:1, from LAN2 to WAN, TCP, service others, DROP [count=3]	192.168.2.3...	162...	ACCESS BLOCK

## How to Restrict Web Portal access from the Internet

This example shows how to use the VPN Setup Wizard to create a site-to-site VPN with multiple LAN access to the VPN tunnel. The example instructs how to configure the VPN tunnel between each site and redirect multiple LAN interface traffic to the VPN tunnel. When the VPN tunnel is configured, multiple LAN subnets can be accessed securely.

ZyWALL/USG Restrict Web Portal Access from the Internet

 Note: All network IP addresses and subnet masks are used as examples in this article. Please replace them with your actual network IP addresses and subnet masks. This example was tested using USG60 (Firmware Version: ZLD 4.25).

## Set Up the ZyWALL/USG System Setting

Go to **CONFIGURATION > System > WWW > Admin Service Control > Add Admin ACL**

**Rule 1.** Set the address access action as **Deny** for **ALL** address in **WAN**.

**CONFIGURATION > System > WWW > Admin Service Control > Add Admin ACL Rule 1**

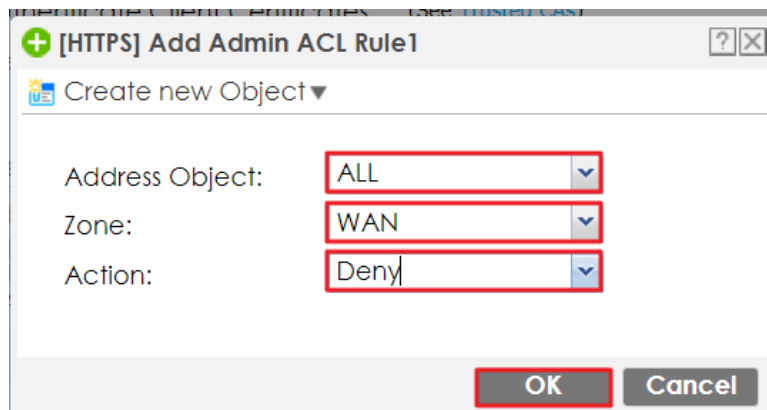

**HTTPS**

Enable

Server Port:

Authenticate Client Certificates (See [Trusted CAs](#))

Server Certificate:

Redirect HTTP to HTTPS

**Admin Service Control**

+ Add Edit Remove Move

#	Zone	Address	Action
1	WAN	ALL	deny
-	ALL	ALL	accept

## Test the Web Access

Login to the device via the WAN interface with the administrator's user name and password. The screen will show **Login denied**.

### Login to the device via the WAN interface

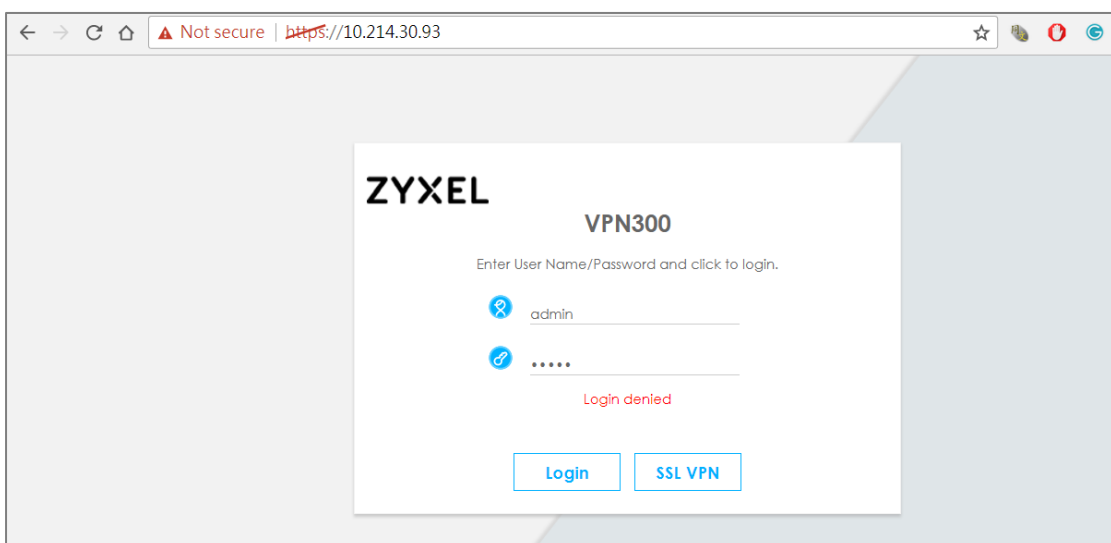



Login to the device via the LAN interface with the administrator's user name and password. The management portal will be displayed.

### Login to the device via the LAN interface

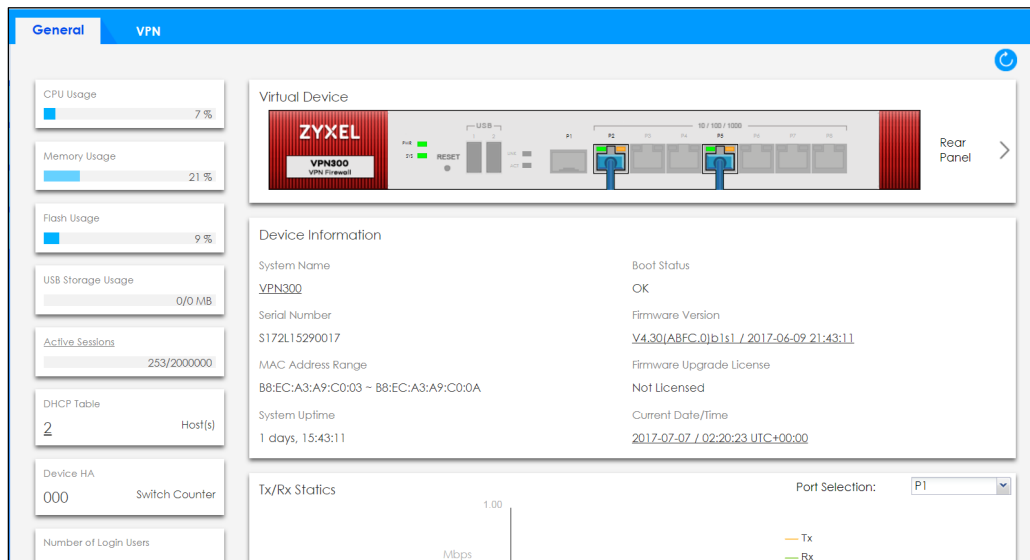
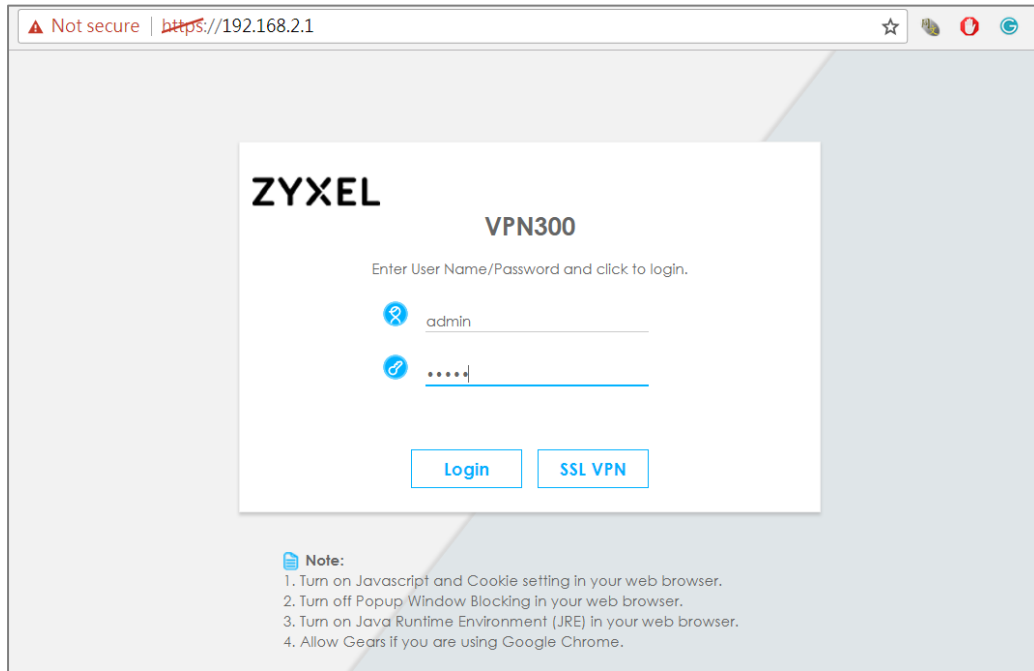

Go to **MONITOR > Log**. You can see that the admin login has been denied access from the WAN interface but it is allowed from the LAN interface.

### MONITOR > Log

**Logs**

Category:

[Email Log Now](#) | [Refresh](#) | [Clear Log](#)

#	Time	Priority	C...	Message	Source	Destination	Note
1	2017...	notice	User	User admin has been denied access from HTTPS	10.214.30.66:63823	10.214.30.93:443	Account:...
51	2017...	notice	User	Administrator admin(MAC=3C:97:0E:30:0E:B8) f...	192.168.2.33	192.168.2.1	Account:...

Page 1 of 1 | Show 50 items | Displaying 1 - 2 of 2

## How to Setup and Configure Daily Report

This example shows how to set up the data collection and view various statistics about traffic passing through your ZyWALL/USG. When the Daily Report is configured, you will receive statistics report every day.

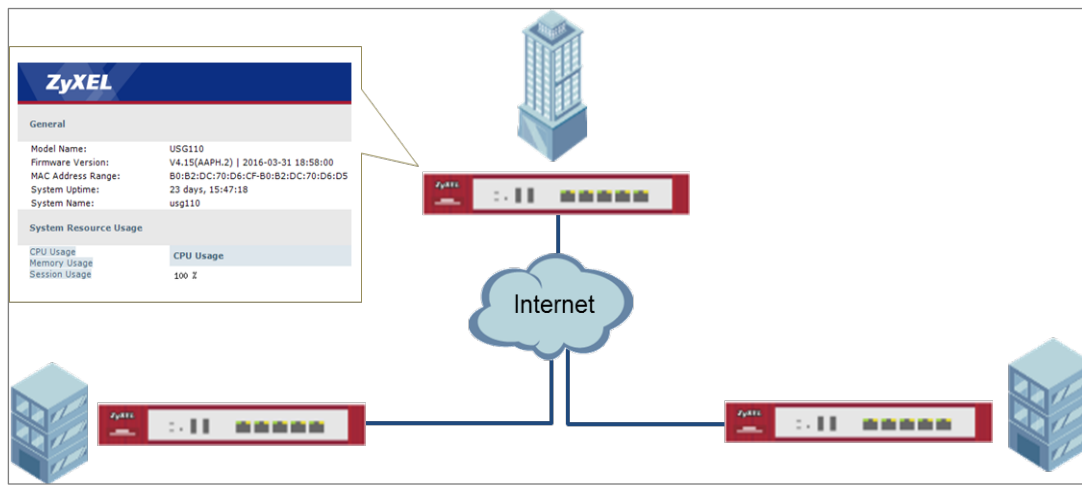

### ZyWALL/USG Setup and Configure Daily Report

 Note: All network IP addresses and subnet masks are used as examples in this article. Please replace them with your actual network IP addresses and subnet masks. This example was tested using USG110 (Firmware Version: ZLD 4.25).

## Set Up the ZyWALL/USG Email Daily Report Setting

Go to **CONFIGURATION > Log & Report > Email Daily Report > General Settings**. Select **Enable Email Daily Report** to send reports by e-mail every day.

### CONFIGURATION > Log & Report > Email Daily Report > General Settings

**General Settings**

Enable Email Daily Report

Type the SMTP server name or IP address. In **Mail From**, type the e-mail address from which the outgoing e-mail is delivered. In **Mail To**, type the e-mail address to which the outgoing e-mail is delivered. Select **SMTP Authentication** if it is necessary to provide a user name and password to the SMTP server.

### CONFIGURATION > Log & Report > Email Daily Report > Email Settings

**Mail Server**

**General Settings**

Mail Server:  (Outgoing SMTP Server Name or IP Address)

Mail Subject:  Append system name  Append date time

Mail Server Port:   TLS Security  STARTTLS  Authenticate Server

Mail From:  (Email Address)

SMTP Authentication

User Name:

Password:

Retype to Confirm:

**Schedule**

Time For Sending Report:  (hours)  (minutes)

In the **CONFIGURATION > Log & Report > Email Daily Report > Schedule**. Select the time of day (hours and minutes) when the log is e-mailed. Use 24-hour notation.

### CONFIGURATION > Log & Report > Email Daily Report > Schedule

**Schedule**

Time For Sending Report:  (hours)  (minutes)

Select the information to include in the report. Types of information include **System Resource Usage**, **Wireless Report**, **Threat Report**, and **Interface Traffic Statistics**.

Select **Reset counters after sending report successfully** if you only want to see statistics for a 24 hour period.

## CONFIGURATION > Log & Report > Email Daily Report > Report Items

### Report Items

System Resource Usage

- CPU Usage
- Memory Usage
- Session Usage
- Port Usage

Wireless Report

- Station Count
- TX Statistics
- RX Statistics
- Content Filter

Interface Traffic Statistics

DHCP Table

Reset counters after sending report successfully

[Reset All Counters](#)

## Test the Daily Log Report

Click **Send Report Now** to have the ZyWALL/USG send the daily e-mail report immediately.

## CONFIGURATION > Log & Report > Email Daily Report > Email Settings

### General Settings

Enable Email Daily Report

### Email Settings

Mail Subject:

Mail To:  (Email Address)  
 (Email Address)  
 (Email Address)  
 (Email Address)  
 (Email Address)

[Send Report Now](#)

You will receive a daily report mail.

### ZyXEL Daily Report Mail

## ZYXEL

### General

Model Name:	VPN300
Firmware Version:	V4.30(ABFC.0)
MAC Address Range:	B8:EC:A3:A9:C0:03-B8:EC:A3:A9:C0:0A
System Uptime:	1 days, 16:53:04
System Name:	VPN300

### System Resource Usage

- CPU Usage
- Memory Usage
- Session Usage
- Port Usage

#### CPU Usage

Last Update: 2017-07-07 03:30:19

03:30

[Back to top](#)

## What Could Go Wrong?

Make sure your Email settings are all correct.

**CONFIGURATION > Log & Report > Email Daily Report > Email Settings**

Mail Server

**General Settings**

Mail Server:  (Outgoing SMTP Server Name or IP Address)

Mail Subject:  Append system name  Append date time

Mail Server Port:   TLS Security  STARTTLS  Authenticate Server

Mail From:  (Email Address)

SMTP Authentication

User Name :

Password:

Retype to Confirm:

**Schedule**

Time For Sending Report:  (hours)  (minutes)

Make sure your ZyWALL to WAN security policy allow.

## How to Setup and Configure Email Logs

This example shows how to set up the e-mail profiles to mail ZyWALL/USG log messages to the specific destinations. You can also specify which log messages to e-mail, and where and how often to e-mail them. When the Email Logs is configured, you will receive logs email report base on customized schedule.

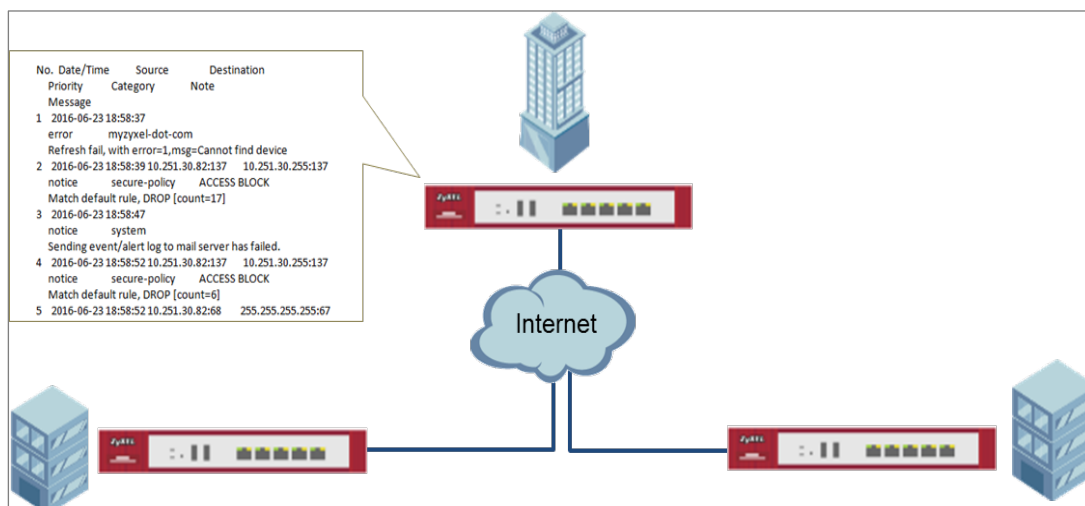

ZyWALL/USG Setup and Configure E-mail Logs

**Note:** All network IP addresses and subnet masks are used as examples in this article. Please replace them with your actual network IP addresses and subnet masks. This example was tested using USG110 (Firmware Version: ZLD 4.25).



## Set Up the ZyWALL/USG Email Logs Setting

1. Go to **CONFIGURATION > Log & Report > Log Settings > System Log > Edit > E-mail Server 1**. Select **Active**. Type the SMTP server name or IP address. In **Mail From**, type the e-mail address from which the outgoing e-mail is delivered. In **Mail To**, type the e-mail address to which the outgoing e-mail is delivered.
2. **Day for Sending Log** is available if the log is e-mailed weekly. Select the day of the week the log is e-mailed.
3. **Time for Sending Log** is available if the log is e-mailed weekly or daily. Select the time of day (hours and minutes) when the log is e-mailed. Use 24-hour notation.
4. Select **SMTP Authentication** if it is necessary to provide a user name and password to the SMTP server.

### CONFIGURATION > Log & Report > Log Settings > System Log > Edit > E-mail Server 1

**E-mail Server 1**

Active

Mail Server:  (Outgoing SMTP Server Name or IP Address)

Mail Server Port:   TLS  STARTTLS  Authentica Security

Mail Subject:

Send From:  (E-Mail Address)

Send Log to:  (E-Mail Address)

Send Alerts to:  (E-Mail Address)

Sending Log:  (Dropdown)

Day for Sending Log:  (Dropdown)

Time for Sending Log:  (Time Picker)

SMTP Authentication

User Name :  (Masked)

Password:  (Masked)

Retype to Confirm:  (Masked)

5. Go to **CONFIGURATION > Log & Report > Log Settings > System Log > Edit > Active Log and Alert**. Use the **System Log** drop-down list to change the log settings for all of the log categories.

**CONFIGURATION > Log & Report > Log Settings > System Log > Edit > Active Log and Alert.**

Active Log and Alert

Log Category +	System Log			E-mail Server 1		E-mail Server 2	
	disable	normal	debug	normal	alert	normal	alert
Auth	<input type="radio"/>	<input type="radio"/>	<input type="radio"/>	<input checked="" type="checkbox"/>	<input type="checkbox"/>	<input checked="" type="checkbox"/>	<input type="checkbox"/>
- PKI	<input type="radio"/>	<input type="radio"/>	<input type="radio"/>	<input checked="" type="checkbox"/>	<input type="checkbox"/>	<input checked="" type="checkbox"/>	<input type="checkbox"/>
- Authentication Server	<input type="radio"/>	<input type="radio"/>	<input type="radio"/>	<input checked="" type="checkbox"/>	<input type="checkbox"/>	<input checked="" type="checkbox"/>	<input type="checkbox"/>
- Auth. Policy	<input type="radio"/>	<input type="radio"/>	<input type="radio"/>	<input checked="" type="checkbox"/>	<input type="checkbox"/>	<input checked="" type="checkbox"/>	<input type="checkbox"/>
- SSO	<input type="radio"/>	<input type="radio"/>	<input type="radio"/>	<input checked="" type="checkbox"/>	<input type="checkbox"/>	<input checked="" type="checkbox"/>	<input type="checkbox"/>
- Web Authentication	<input type="radio"/>	<input type="radio"/>	<input type="radio"/>	<input checked="" type="checkbox"/>	<input type="checkbox"/>	<input checked="" type="checkbox"/>	<input type="checkbox"/>
- Account	<input type="radio"/>	<input type="radio"/>	<input type="radio"/>	<input checked="" type="checkbox"/>	<input type="checkbox"/>	<input checked="" type="checkbox"/>	<input type="checkbox"/>
- User	<input type="radio"/>	<input type="radio"/>	<input type="radio"/>	<input checked="" type="checkbox"/>	<input type="checkbox"/>	<input checked="" type="checkbox"/>	<input type="checkbox"/>
BWM	<input type="radio"/>	<input type="radio"/>	<input type="radio"/>	<input checked="" type="checkbox"/>	<input type="checkbox"/>	<input checked="" type="checkbox"/>	<input type="checkbox"/>
Device HA	<input type="radio"/>	<input type="radio"/>	<input type="radio"/>	<input checked="" type="checkbox"/>	<input type="checkbox"/>	<input checked="" type="checkbox"/>	<input type="checkbox"/>
File manager	<input type="radio"/>	<input type="radio"/>	<input type="radio"/>	<input checked="" type="checkbox"/>	<input type="checkbox"/>	<input checked="" type="checkbox"/>	<input type="checkbox"/>
License	<input type="radio"/>	<input type="radio"/>	<input type="radio"/>	<input checked="" type="checkbox"/>	<input type="checkbox"/>	<input checked="" type="checkbox"/>	<input type="checkbox"/>
Log & Report	<input type="radio"/>	<input type="radio"/>	<input type="radio"/>	<input checked="" type="checkbox"/>	<input type="checkbox"/>	<input checked="" type="checkbox"/>	<input type="checkbox"/>
Network	<input type="radio"/>	<input type="radio"/>	<input type="radio"/>	<input checked="" type="checkbox"/>	<input type="checkbox"/>	<input checked="" type="checkbox"/>	<input type="checkbox"/>

Active Log and Alert (AP)

Log Category +	System Log			E-mail Server 1		E-mail Server 2	
	disable	normal	debug	normal	alert	normal	alert
Auth	<input type="radio"/>	<input type="radio"/>	<input type="radio"/>	<input checked="" type="checkbox"/>	<input type="checkbox"/>	<input checked="" type="checkbox"/>	<input type="checkbox"/>
File manager	<input type="radio"/>	<input type="radio"/>	<input type="radio"/>	<input checked="" type="checkbox"/>	<input type="checkbox"/>	<input checked="" type="checkbox"/>	<input type="checkbox"/>
Log & Report	<input type="radio"/>	<input type="radio"/>	<input type="radio"/>	<input checked="" type="checkbox"/>	<input type="checkbox"/>	<input checked="" type="checkbox"/>	<input type="checkbox"/>
Network	<input type="radio"/>	<input type="radio"/>	<input type="radio"/>	<input checked="" type="checkbox"/>	<input type="checkbox"/>	<input checked="" type="checkbox"/>	<input type="checkbox"/>
Routing	<input type="radio"/>	<input type="radio"/>	<input type="radio"/>	<input checked="" type="checkbox"/>	<input type="checkbox"/>	<input checked="" type="checkbox"/>	<input type="checkbox"/>
System	<input type="radio"/>	<input type="radio"/>	<input type="radio"/>	<input checked="" type="checkbox"/>	<input type="checkbox"/>	<input checked="" type="checkbox"/>	<input type="checkbox"/>
Wireless	<input type="radio"/>	<input type="radio"/>	<input type="radio"/>	<input checked="" type="checkbox"/>	<input type="checkbox"/>	<input checked="" type="checkbox"/>	<input type="checkbox"/>

## Test the Email Log

You will receive a log mail depends on the time you set in the E-mail Server.

### ZyXEL Log Mail

From: zyxelsupporttest.com.tw  
 To: zyxelsupporttest.com.tw  
 Cc:  
 Subject: ZyXEL Log Report

No.	Date/Time	Source	Destination	Category	Note
1	2016-06-23 15:52:53			system	notice
					Sending event/alert log to mail server has succeeded.
2	2016-06-23 15:52:55	10.251.30.61:137	10.251.30.255:137	secure-policy	ACCESS BLOCK
					Match default rule, DROP [count=3]
3	2016-06-23 15:52:59	10.251.30.61:138	10.251.30.255:138	secure-policy	ACCESS BLOCK
					Match default rule, DROP
4	2016-06-23 15:53:03	10.251.30.93:17500	255.255.255.255:17500	secure-policy	ACCESS BLOCK
					Match default rule, DROP [count=2]
5	2016-06-23 15:53:03	10.251.30.93:17500	10.251.30.255:17500	secure-policy	ACCESS BLOCK
					Match default rule, DROP
6	2016-06-23 15:53:06	10.251.30.38:137	10.251.30.255:137	secure-policy	ACCESS BLOCK
					Match default rule, DROP [count=3]
7	2016-06-23 15:53:10	10.251.30.40:137	10.251.30.255:137	secure-policy	ACCESS BLOCK
					Match default rule, DROP [count=3]
8	2016-06-23 15:53:10	10.251.30.40:68	255.255.255.255:67	secure-policy	ACCESS BLOCK
					Match default rule, DROP

## What Could Go Wrong?

Make sure your Email settings are all correct.

### CONFIGURATION > Log & Report > Email Daily Report > Email Settings

**E-mail Server 1**

Active

Mail Server:  (Outgoing SMTP Server Name or IP Address)

Mail Server Port:   TLS  STARTTLS  Authentica Security

Mail Subject:

Send From:  (E-Mail Address)

Send Log to:  (E-Mail Address)

Send Alerts to:  (E-Mail Address)

Sending Log:

Day for Sending Log:

Time for Sending Log:

SMTP Authentication

User Name :

Password:

Retype to Confirm:

Make sure your ZyWALL to WAN security policy allow.

## How to Setup and send logs to a Syslog Server

This example shows how to set up the syslog server profiles to mail ZyWALL/USG log messages to the specific destinations. You can also specify which log messages to syslog server. When the syslog server is configured, you will receive the real time system logs.

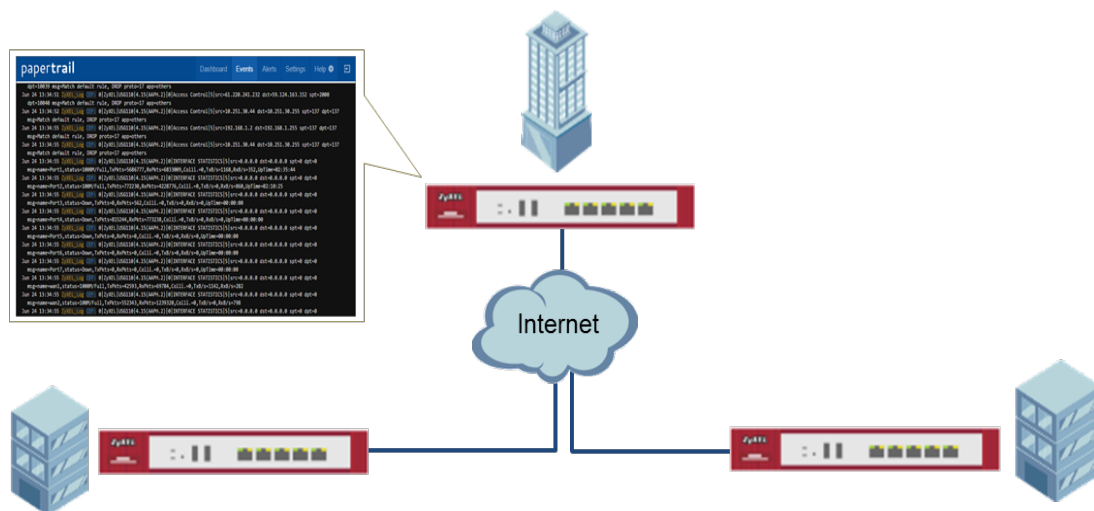

ZyWALL/USG Setup and Configure sending logs to a syslog and Vantage Reports Server

 **Note:** All network IP addresses and subnet masks are used as examples in this article. Please replace them with your actual network IP addresses and subnet masks. This example was tested using USG110 (Firmware Version: ZLD 4.25).

## Set Up the Syslog Server (Use Papertrail syslog in this example)

Register an account on Papertrail: <https://papertrailapp.com>

Go to **Dashboard > Add Systems**.

**Dashboard > Add Systems**

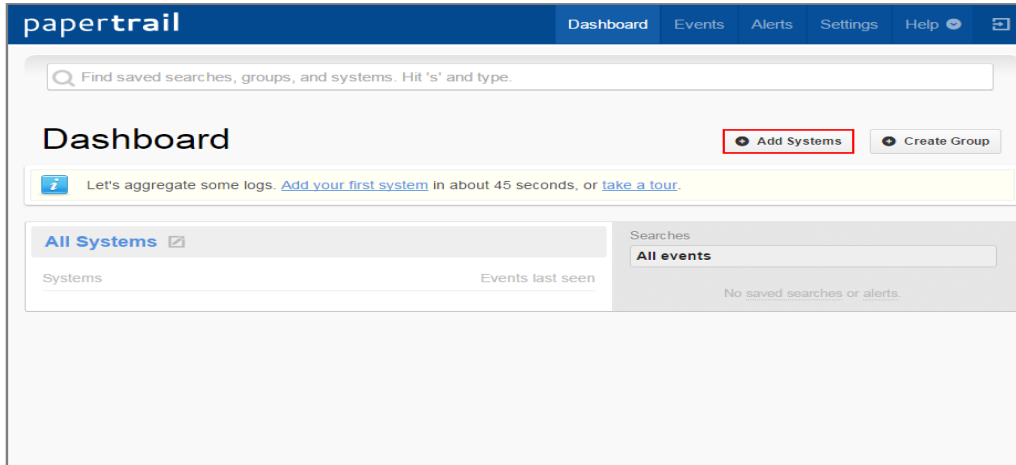

Select **Not shown here?** and **My syslog daemon only sends to port 514**.

**Dashboard > Add Systems > I'm using**

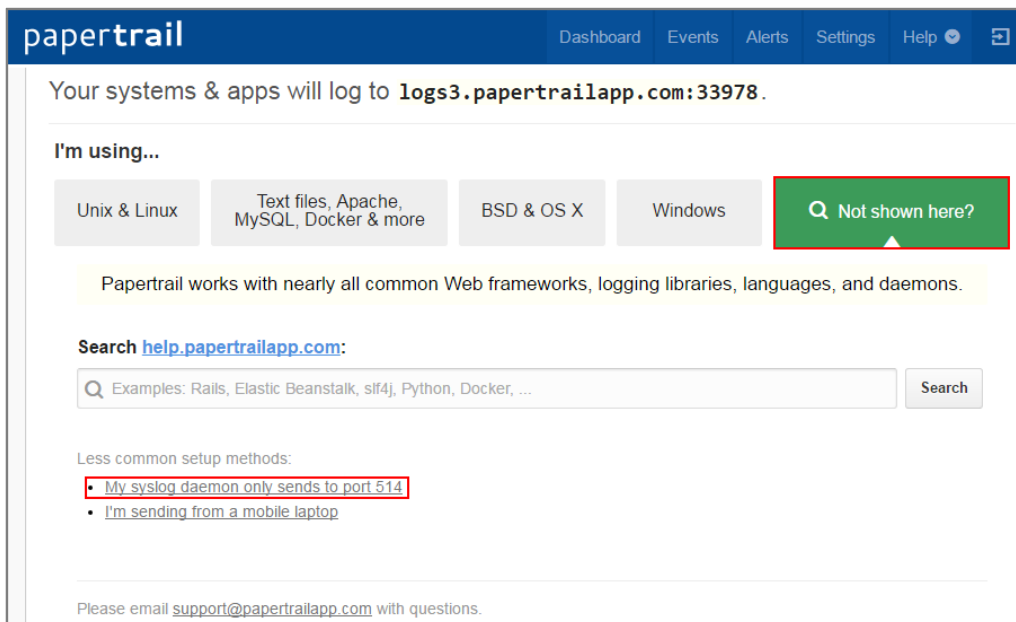

Select **My syslogd only uses the default port**, set ZyWALL/USG public IP address (111.250.188.9 in this example) and name the log system. Click **Save**.

**Dashboard > Add Systems > > I'm using > Choose your situation**

**papertrail** Dashboard Events Alerts Settings Help

Choose your situation:

- A My syslogd only uses the default port**  
GNU syslogd and some embedded devices will only log to port 514. A few old Linux distro versions use GNU syslogd (mostly CentOS and Gentoo).
- B I use Cloud Foundry**  
Register each app separately. Use Heroku? [Here's how](#).
- C My system's hostname changes**  
In rare cases, one system may change hostnames frequently. For example, a roaming laptop which sets its hostname based on DHCP (and roams across networks).

Let's create a log destination on port 514 that works with GNU syslogd.

Multiple systems share 1 IP (NAT)? Enter the same IP for each. We'll do the rest.

111.250.188.9  
Example: 208.57.123.234

What should we call it?  
ZyXEL\_Log  
Examples: www42, SYS\_1, db1.example.com. Does not need to match hostname.

Save

Write down the Papertrail-provided domain name (logs.papertrailapp.com in this example).

Dashboard > Add Systems >> I'm using > Choose your situation > System Created

**papertrail** Dashboard Events Alerts Settings Help

## Setup ZyXEL\_Log...

System created.

ZyXEL\_Log will log to logs.papertrailapp.com.

I'm using...

Unix & Linux Text files, Apache, MySQL, Docker & more BSD & OS X Windows Not shown here?

**1** See which logger your system uses. Run:

```
ls -d /etc/*syslog*
```

Which filename is listed?

rsyslog.conf

## Set Up the ZyWALL/USG Remote Server Setting

1. Go to **CONFIGURATION > Log & Report > Log Settings > Remote Server > Edit**. Set **Log Format** to be **CEF/Syslog**. Type the **Server Address** to be the Papertrail- provided domain name (logs.papertrailpp.com in this example).
2. Use the **System Log** drop-down list to change the log settings for all of the log categories.

### CONFIGURATION > Log & Report > Log Settings > Remote Server > Edit

#### Log Settings for Remote Server

Active

Log Format: CEF/Syslog

Server Address: logs.papertrailpp.com (Server Name or IP Address)

Log Facility: Local 1

#### Active Log

Log Category +	Selection		
	disable	normal	debug
+ Auth	<input type="radio"/>	<input type="radio"/>	<input type="radio"/>
+ BWM	<input checked="" type="radio"/>	<input type="radio"/>	<input type="radio"/>
+ Device HA	<input checked="" type="radio"/>	<input type="radio"/>	<input type="radio"/>
+ File manager	<input checked="" type="radio"/>	<input type="radio"/>	<input type="radio"/>
+ License	<input checked="" type="radio"/>	<input type="radio"/>	<input type="radio"/>
+ Log & Report	<input checked="" type="radio"/>	<input type="radio"/>	<input type="radio"/>
+ Network	<input checked="" type="radio"/>	<input type="radio"/>	<input type="radio"/>
+ None	<input checked="" type="radio"/>	<input type="radio"/>	<input type="radio"/>

## Test the Remote Server

You will receive a log mail depends on the time you set in the E-mail Server.

### ZyXEL Log Mail

```
papertrail Dashboard Events Alerts Settings Help  
dpt=10039 msg=Match default rule, DROP proto=17 app=others  
Jun 24 13:34:51 ZyXEL_Log CEF: 0|ZyXEL|USG110|4.15(AAPH.2)|0|Access Control|5|src=61.220.241.232 dst=59.124.163.152 spt=2000  
dpt=10040 msg=Match default rule, DROP proto=17 app=others  
Jun 24 13:34:52 ZyXEL_Log CEF: 0|ZyXEL|USG110|4.15(AAPH.2)|0|Access Control|5|src=10.251.30.44 dst=10.251.30.255 spt=137 dpt=137  
msg=Match default rule, DROP proto=17 app=others  
Jun 24 13:34:55 ZyXEL_Log CEF: 0|ZyXEL|USG110|4.15(AAPH.2)|0|Access Control|5|src=192.168.1.2 dst=192.168.1.255 spt=137 dpt=137  
msg=Match default rule, DROP proto=17 app=others  
Jun 24 13:34:55 ZyXEL_Log CEF: 0|ZyXEL|USG110|4.15(AAPH.2)|0|Access Control|5|src=10.251.30.44 dst=10.251.30.255 spt=137 dpt=137  
msg=Match default rule, DROP proto=17 app=others  
Jun 24 13:34:55 ZyXEL_Log CEF: 0|ZyXEL|USG110|4.15(AAPH.2)|0|INTERFACE STATISTICS|5|src=0.0.0.0 dst=0.0.0.0 spt=0 dpt=0  
msg=name=Port1,status=1000M/Full,TxPkts=5686777,RxPkts=6833009,Colli.=0,TxB/s=1168,RxB/s=352,UpTime=02:35:44  
Jun 24 13:34:55 ZyXEL_Log CEF: 0|ZyXEL|USG110|4.15(AAPH.2)|0|INTERFACE STATISTICS|5|src=0.0.0.0 dst=0.0.0.0 spt=0 dpt=0  
msg=name=Port2,status=100M/Full,TxPkts=772230,RxPkts=4228776,Colli.=0,TxB/s=0,RxB/s=860,UpTime=02:10:25  
Jun 24 13:34:55 ZyXEL_Log CEF: 0|ZyXEL|USG110|4.15(AAPH.2)|0|INTERFACE STATISTICS|5|src=0.0.0.0 dst=0.0.0.0 spt=0 dpt=0  
msg=name=Port3,status=Down,TxPkts=0,RxPkts=562,Colli.=0,TxB/s=0,RxB/s=0,UpTime=00:00:00  
Jun 24 13:34:55 ZyXEL_Log CEF: 0|ZyXEL|USG110|4.15(AAPH.2)|0|INTERFACE STATISTICS|5|src=0.0.0.0 dst=0.0.0.0 spt=0 dpt=0  
msg=name=Port4,status=Down,TxPkts=815244,RxPkts=773238,Colli.=0,TxB/s=0,RxB/s=0,UpTime=00:00:00  
Jun 24 13:34:55 ZyXEL_Log CEF: 0|ZyXEL|USG110|4.15(AAPH.2)|0|INTERFACE STATISTICS|5|src=0.0.0.0 dst=0.0.0.0 spt=0 dpt=0  
msg=name=Port5,status=Down,TxPkts=0,RxPkts=0,Colli.=0,TxB/s=0,RxB/s=0,UpTime=00:00:00  
Jun 24 13:34:55 ZyXEL_Log CEF: 0|ZyXEL|USG110|4.15(AAPH.2)|0|INTERFACE STATISTICS|5|src=0.0.0.0 dst=0.0.0.0 spt=0 dpt=0  
msg=name=Port6,status=Down,TxPkts=0,RxPkts=0,Colli.=0,TxB/s=0,RxB/s=0,UpTime=00:00:00  
Jun 24 13:34:55 ZyXEL_Log CEF: 0|ZyXEL|USG110|4.15(AAPH.2)|0|INTERFACE STATISTICS|5|src=0.0.0.0 dst=0.0.0.0 spt=0 dpt=0  
msg=name=Port7,status=Down,TxPkts=0,RxPkts=0,Colli.=0,TxB/s=0,RxB/s=0,UpTime=00:00:00  
Jun 24 13:34:55 ZyXEL_Log CEF: 0|ZyXEL|USG110|4.15(AAPH.2)|0|INTERFACE STATISTICS|5|src=0.0.0.0 dst=0.0.0.0 spt=0 dpt=0  
msg=name=wan1,status=1000M/Full,TxPkts=42593,RxPkts=69784,Colli.=0,TxB/s=1142,RxB/s=282  
Jun 24 13:34:55 ZyXEL_Log CEF: 0|ZyXEL|USG110|4.15(AAPH.2)|0|INTERFACE STATISTICS|5|src=0.0.0.0 dst=0.0.0.0 spt=0 dpt=0  
msg=name=wan2,status=100M/Full,TxPkts=552343,RxPkts=1239320,Colli.=0,TxB/s=0,RxB/s=798  
Jun 24 13:34:55 ZyXEL_Log CEF: 0|ZyXEL|USG110|4.15(AAPH.2)|0|INTERFACE STATISTICS|5|src=0.0.0.0 dst=0.0.0.0 spt=0 dpt=0
```



## What Could Go Wrong?

Make sure your **Log settings for Remote Server** are all correct.

**CONFIGURATION > Log & Report > Log Settings > Remote Server**

### Log Settings for Remote Server

Active

Log Format:  (Server Name or IP Address)

Server Address:  (Server Name or IP Address)

Log Facility:

### Active Log

Log Category +	Selection		
	disable	normal	debug
+ Auth	<input type="radio"/>	<input type="radio"/>	<input type="radio"/>
+ BWM	<input type="radio"/>	<input type="radio"/>	<input type="radio"/>
+ Device HA	<input type="radio"/>	<input type="radio"/>	<input type="radio"/>
+ File manager	<input type="radio"/>	<input type="radio"/>	<input type="radio"/>
+ License	<input type="radio"/>	<input type="radio"/>	<input type="radio"/>
+ Log & Report	<input type="radio"/>	<input type="radio"/>	<input type="radio"/>
+ Network	<input type="radio"/>	<input type="radio"/>	<input type="radio"/>
+ None	<input type="radio"/>	<input type="radio"/>	<input type="radio"/>

Make sure your ZyWALL to WAN security policy allow traffic to log server.



## Set Up the VRPT Server

1. The Vantage Report server must have register an account in <http://www.myZyXEL.com>.
2. Install VRPT software:
3. <http://www.zyxel.com/support/DownloadLandingSR.shtml?c=gb&l=en&kbid=M-01339&md=VRPT>
4. Unzipped the file and click **Vantage Reeport.exe** to start installing Vantage Report. Then, the Vantage Report installation wizard appears. Click **Next**.

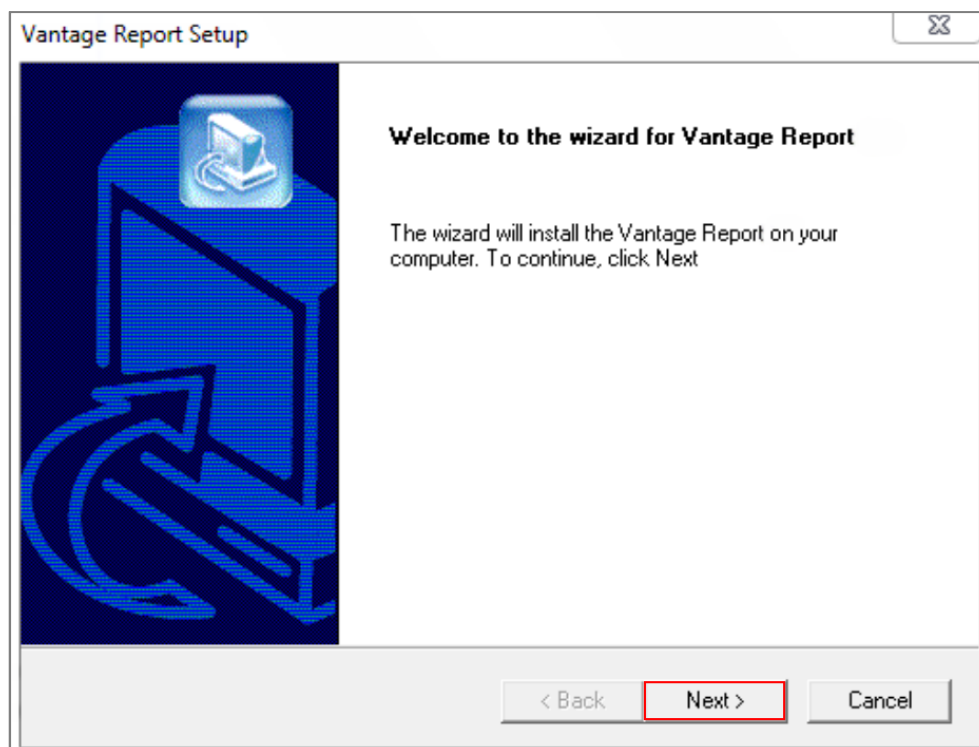

5. Enter the port number you want Vantage Report to use for web services. Make sure this port number does not conflict with the other services in your network. Click **Next**.

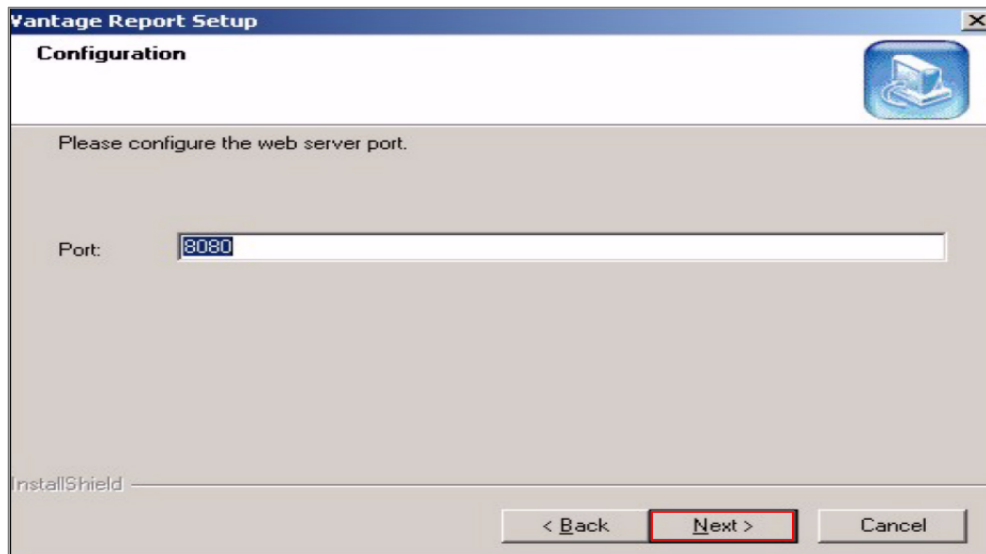

6. Check if any applications also use port 3316 (TCP), 514 (UDP) or 8080 (UDP) by entering "netstat -a" into the command line. Uninstall them if any. Click **OK**.

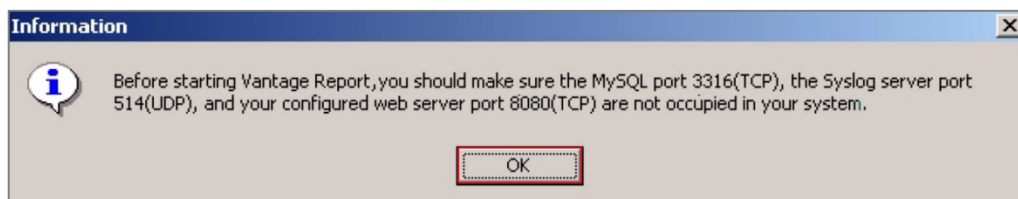

When you finish installing Vantage Report, restart the Vantage Report server.

7. Open the browser window and go to <http://a.b.c.d:xxxxxx/vrpt>, where **a.b.c.d** is the IP address of the Vantage Report server. If you open the configurator on the same computer on which you installed Vantage Report server, enter **localhost**.

Xxxx is the port number you entered during installation (10.251.30.61:8080/vrpt/ in this example).

In the login screen, enter default login **User Name** and **Password: root**.

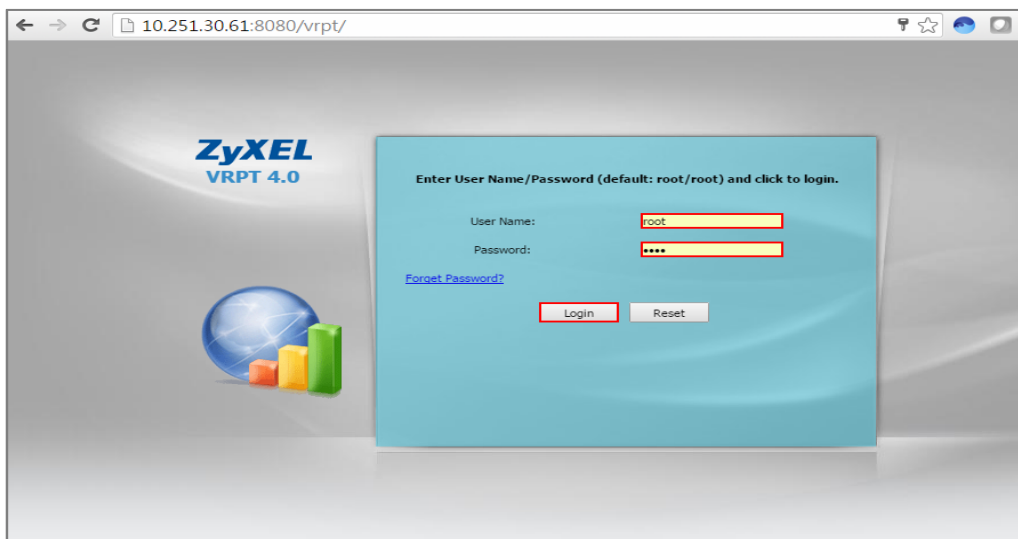

8. Go to **Dashboard > License Information > Manage Device**, click **Add Device**, the **Add Device** screen appears on the left side. Enter the **Name** of the device you want to add to Vantage Report. Enter the LAN **MAC** address of the device you want to add. Select the model **Type** of the device you want to add. Click the **Add** button.

**Dashboard > License Information > Manage Device**

The screenshot shows the ZyXEL dashboard interface. On the left, there is a sidebar with a user profile for 'root' and 'usg110'. A red box highlights the 'Add Device' form, which includes fields for 'Name', 'MAC', 'Type' (set to 'ZyWALL 110'), and 'Note', along with an 'Add' button. The main content area is titled 'Dashboard' and contains two panels: 'Server Information' and 'License Information'.

Software Version	4.0.05.61.00
Release Date	2014-09-15
Free Disk Space	55GB
Max JVM Memory Size	455 MB
Total JVM Memory Size	277 MB
Used JVM Memory Size	110 MB
Free JVM Memory Size	166 MB

Status	Full Version
Account on myzyxel.com	MichelleTest
Authentication Code(AC)	05509D53671C821CD16CF4D210DF4E93880C
Max Supported Devices	100
License Allowed Devices	1
Managed Devices	1
Copyright	© ZyXEL Communications Corporation.

An 'Add Device' button is visible at the bottom right of the License Information panel.

## Set Up the ZyWALL/USG Remote Server Setting

Go to **CONFIGURATION > Log & Report > Log Settings > Remote Server > Edit**. Set **Log Format** to be **VRPT/Syslog**. Type the **Server Address** to be the Vantage Report server IP address (10.251.30.61 in this example).

Use the **System Log** drop-down list to change the log settings for all of the log categories.

**CONFIGURATION > Log & Report > Log Settings > Remote Server > Edit**

### Log Settings for Remote Server

Active

Log Format: VRPT/Syslog

Server Address: 10.251.30.61 (Server Name or IP Address)

Log Facility: Local 1

---

### Active Log (AC)

Selection

#	Log Category	Selection
		<input type="checkbox"/> <input checked="" type="checkbox"/> <input checked="" type="checkbox"/>
1	Account	<input type="checkbox"/> <input checked="" type="checkbox"/> <input type="checkbox"/>
2	ADP	<input type="checkbox"/> <input checked="" type="checkbox"/> <input type="checkbox"/>
3	Anti-Spam	<input type="checkbox"/> <input checked="" type="checkbox"/> <input type="checkbox"/>
4	Anti-Virus	<input type="checkbox"/> <input checked="" type="checkbox"/> <input type="checkbox"/>
5	AP Firmware	<input type="checkbox"/> <input checked="" type="checkbox"/> <input type="checkbox"/>
6	Application Patrol	<input type="checkbox"/> <input checked="" type="checkbox"/> <input type="checkbox"/>
7	Auth. Policy	<input type="checkbox"/> <input checked="" type="checkbox"/> <input type="checkbox"/>
8	Authentication Server	<input type="checkbox"/> <input checked="" type="checkbox"/> <input type="checkbox"/>
9	Blocked web sites	<input type="checkbox"/> <input checked="" type="checkbox"/> <input type="checkbox"/>

## Test the Remote Server

In the VRPT Sever, go to **Logs > Log Viewer**, click **Search**. The screen displays the device log information. (It may take 5 - 10 minutes to display the log after just added the device)

### VRPT Server > Logs > Log Viewer

### Log Viewer

Day: 2016-06-27
Start Time: 00 : 00
End Time: 24 : 00
Days:  Days
Start Date: 2016-06-27
End Date: 2016-06-27

Category: All Categories
Severity: All

Logs per Page: 10
 Reverse DNS

Advanced Search

Search
Reset
Export

Time	Source:Port	Destination:Port	User	Severity	Category	Message	Note
2016-06-27 16:42:31	0.0.0.0:68	255.255.255.255:67	unknown	Notice	Security Policy Control	Match default rule, DROP	ACCESS BLOCK
2016-06-27 16:42:31	10.251.30.231:57450	255.255.255.255:10505	unknown	Notice	Security Policy Control	Match default rule, DROP	ACCESS BLOCK
2016-06-27 16:42:31	192.168.0.121:57448	255.255.255.255:10505	unknown	Notice	Security Policy Control	Match default rule, DROP	ACCESS BLOCK
2016-06-27 16:42:31	169.254.1.1:57446	255.255.255.255:10505	unknown	Notice	Security Policy Control	Match default rule, DROP	ACCESS BLOCK
2016-06-27 16:42:31	192.168.1.2:137	192.168.1.255:137	unknown	Notice	Security Policy Control	Match default rule, DROP	ACCESS BLOCK

Total Count:7,365 Total Page:737 First [1](#) [2](#) [3](#) [4](#) [5](#) [6](#) [7](#) [8](#) [9](#) [10](#) Last  Go

## What Could Go Wrong?

Make sure your **Log settings for Remote Server** are all correct.

## CONFIGURATION > Log & Report > Log Settings > Remote Server

**Log Settings for Remote Server**

Active

Log Format:  (dropdown)

Server Address:  (Server Name or IP Address)

Log Facility:  (dropdown)

**Active Log (AC)**

#	Log Category	Selection
1	Account	<input checked="" type="checkbox"/> <input checked="" type="checkbox"/> <input checked="" type="checkbox"/>
2	ADP	<input type="checkbox"/> <input type="checkbox"/> <input type="checkbox"/>
3	Anti-Spam	<input type="checkbox"/> <input type="checkbox"/> <input type="checkbox"/>
4	Anti-Virus	<input type="checkbox"/> <input type="checkbox"/> <input type="checkbox"/>
5	AP Firmware	<input type="checkbox"/> <input type="checkbox"/> <input type="checkbox"/>
6	Application Patrol	<input type="checkbox"/> <input type="checkbox"/> <input type="checkbox"/>
7	Auth. Policy	<input type="checkbox"/> <input type="checkbox"/> <input type="checkbox"/>
8	Authentication Server	<input type="checkbox"/> <input type="checkbox"/> <input type="checkbox"/>
9	Blocked web sites	<input type="checkbox"/> <input type="checkbox"/> <input type="checkbox"/>

Make sure your ZyWALL to WAN security policy allow traffic to log server.

## How to Setup and send logs to the USB storage

This example shows how to use the USB device to store the system log information.

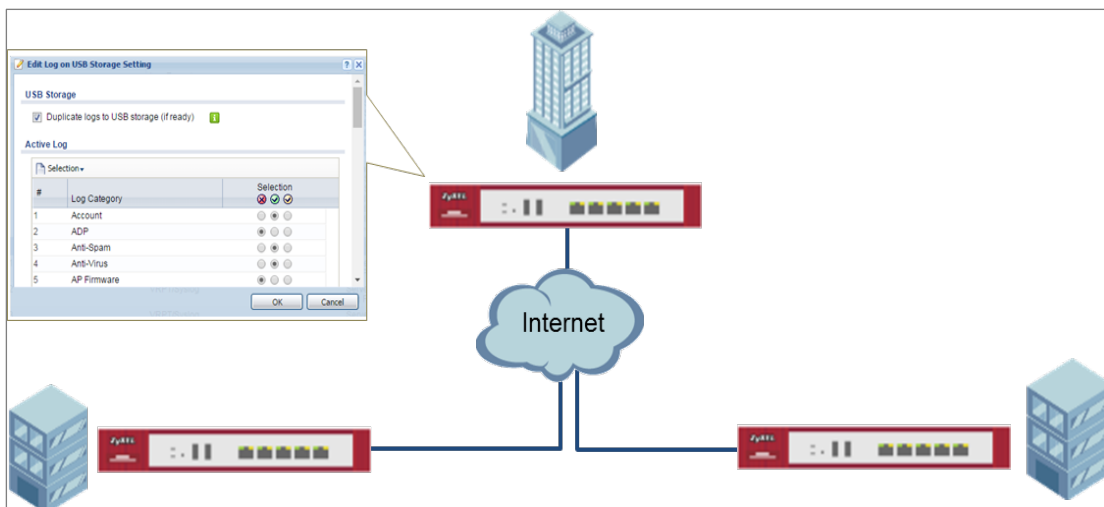



ZyWALL/USG enable and send logs to the USB storage

 Note: Only connect one USB device. It must allow writing (it cannot be read-only) and use the FAT16, FAT32, EXT2, or EXT3 file system. This example was tested using USG110 (Firmware Version: ZLD 4.25).

## Set Up the USB System Settings

Go to **CONFIGURATION > System > USB Storage > Settings > General**. Select **Activate USB storage service** if you want to use the connected USB device(s).

Set a number and select a unit (MB or %) to have the ZyWALL/USG send a warning message when the remaining USB storage space is less than the value you set here.

**CONFIGURATION > System > USB Storage > Settings > General**

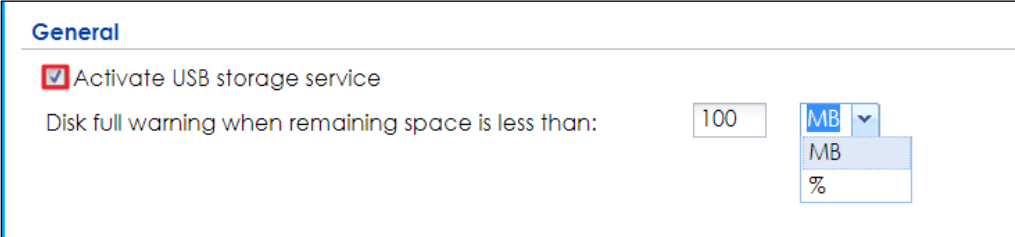

**General**

Activate USB storage service

Disk full warning when remaining space is less than:  MB

MB

%

## Set Up the USB Log Storage

Go to **CONFIGURATION > Log & Report > Log Settings**, select **USB Storage** and click **Activate**. Click **Apply** to save your changes.

### CONFIGURATION > Log & Report > Log Settings

#	Status	Name	Log Format	Summary
1	🔔	System Log	Internal	E-mail Server 1 Mail Server: mail.zyxel.com.tw Mail Subject: Handbook test Send From: Chris.liao@zyxel.com.tw Send Log to: Chris.liao@zyxel.com.tw Send Alert to: Schedule: Send log daily at 10:00
2	🔔	System Log	Internal	E-mail Server 2 Mail Server: Mail Subject: Send From: Send Log to: Send Alert to: Schedule: Send log when full.
3	🔔	USB Storage	Internal	USB Status: Ready
4	🔔	Remote Server 1	VRPT/Syslog	Server Address: Log Facility: Local 1
5	🔔	Remote Server 2	VRPT/Syslog	Server Address: Log Facility: Local 1
6	🔔	Remote Server 3	VRPT/Syslog	Server Address: Log Facility: Local 1
7	🔔	Remote Server 4	VRPT/Syslog	Server Address: Log Facility: Local 1

Page 1 of 1 | Show 50 items | Displaying 1 - 7 of 7

Go to **CONFIGURATION > Log & Report > Log Settings > USB Storage > Edit**. Select **Duplicate logs to USB storage (if ready)** to have the ZyWALL/USG save a copy of its system logs to a connected USB storage device. Use the **Selection** drop-down list to change the log settings for all of the log categories.

### CONFIGURATION > Log & Report > Log Settings

**USB Storage**

Duplicate logs to USB storage (if ready) ⓘ

---

**Log Keep duration**

Enable log keep duration

Keep duration:  (1-365 days)

---

**Active Log**

Log Category +	disable	normal	debug
+ Auth	<input type="radio"/>	<input type="radio"/>	<input type="radio"/>
+ BWM	<input type="radio"/>	<input type="radio"/>	<input type="radio"/>
+ Device HA	<input type="radio"/>	<input type="radio"/>	<input type="radio"/>
+ File manager	<input type="radio"/>	<input type="radio"/>	<input type="radio"/>
+ License	<input type="radio"/>	<input type="radio"/>	<input type="radio"/>
+ Log & Report	<input type="radio"/>	<input type="radio"/>	<input type="radio"/>
+ Network	<input type="radio"/>	<input type="radio"/>	<input type="radio"/>
+ None	<input type="radio"/>	<input type="radio"/>	<input type="radio"/>
+ Routing	<input type="radio"/>	<input type="radio"/>	<input type="radio"/>
+ Security	<input type="radio"/>	<input type="radio"/>	<input type="radio"/>
+ System	<input type="radio"/>	<input type="radio"/>	<input type="radio"/>
+ UTM	<input type="radio"/>	<input type="radio"/>	<input type="radio"/>
+ VPN	<input type="radio"/>	<input type="radio"/>	<input type="radio"/>
+ Wireless	<input type="radio"/>	<input type="radio"/>	<input type="radio"/>

## Check the USG Log Files

Connect the USB to PC and you can find the files in the following path: \Model Name\_dir\centralized\_log\YYYY-MM-DD.log

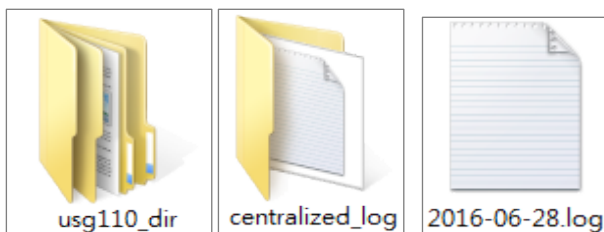

## How to Activate a Free Access Hotspot

Some hotels need to provide free Internet services to hundreds of guests on a daily

basis, and managing the Internet access for so many people can be very complicated without the right equipment. With web authentication methods such as user agreement and web portal, hotel guests are redirected to a web-based authentication portal upon the first attempt to access the network. In some countries, the law requires the identification and tracking of users who use public Internet access. The USG1100 can authenticate people by forcing them to receive an authentication code via SMS on their phone. In this way, the USG1100 can authorize the user's Internet access via their mobile phone number and keep track of the device in case of illegal activities via the hotspot. Guests can get free access to the Internet in a matter of seconds simply by entering all required personal contact information and agreeing to the policy of user agreement. If a user that does not have a guest account wants to access the free Internet for a specified period of time, his or her mobile phone number must be entered to receive the guest account information by SMS.

## User Agreement

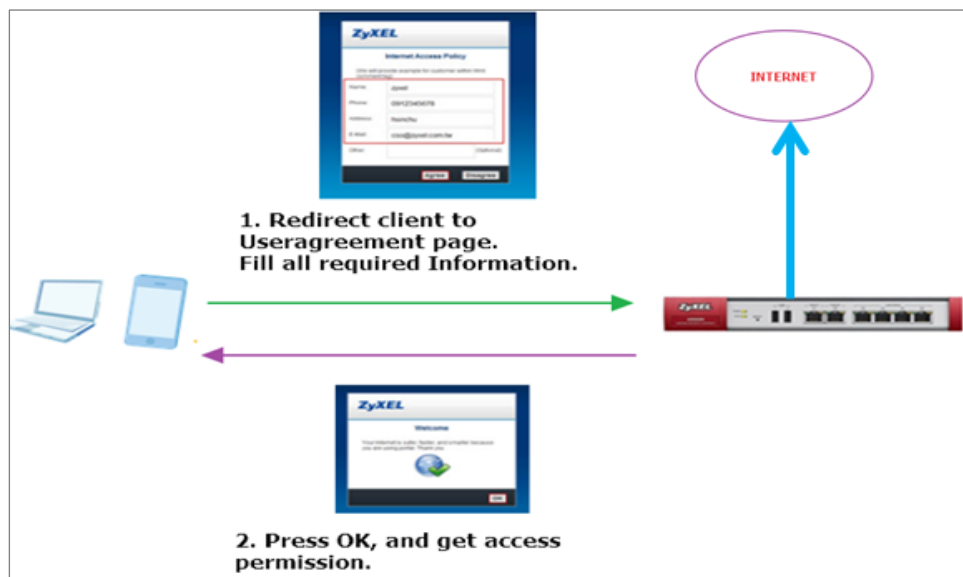

## Configuration Guide Network Conditions

- WAN: 10.251.31.112
- LAN 1: 192.168.1.1/255.255.255.0
- User's laptop: 192.168.1.33

## Set up the Free Access Hotspot

### Configurations on the USG1100

The user agreement of this feature allows clients to access the Internet without a guest account. An advertisement webpage is used as the first page when an authenticated user attempts to access the Internet.

1. On the USG1100, go to **Configuration > Web Authentication > General**. Select **Enable Web Authentication** and click **Add** in the **Web Authentication Policy Summary** section.

(1) Select **Enable Policy**.

(2) Select **Lan\_Subnet\_GE3**

(3) Select **default-user-agreement** as the **Authentication Type**.

(4) Click **OK** to add the policy.

**General Settings**

Enable Policy

Description:  (Optional)

---

**User Authentication Policy**

Incoming Interface:

Source Address:  INTERFACE SUBNET, 192.168.1.0/24

Destination Address:

Schedule:

Authentication:

Single Sign-on

Force User Authentication i

Authentication Type:

**Web Authentication Policy Summary**

#	St...	Priority	Incomin...	Source	Destination	Schedule	Authenti...	Authenticati...	Descripti...
1		1	any	LAN_SUBNET...	any	none	SSO/force	default-user...	
2		Default	any	any	any	none	unneces...	n/a	n/a

Page 1 of 1 Show 50 items Displaying 1 - 2 of 2

Go to

## Configuration > Hotspot > Advertisement.

- (1) Select **Enable Advertisement**.
- (2) Add the URL of the website that you want to advertise.

**ZyXEL USG1100** Welcome admin | Logout | ? Help | About | Site Map

**CONFIGURATION** Advertisement

Quick Setup

**General Settings**

Enable Advertisement

**Advertisement Summary**

#	Name	URL
1	zyxel	http://www.zyxel.com

Page 1 of 1 Show 50 items

## Test the User Agreement and Advertisement Webpage

1. When a client attempts to access the Internet via a browser, he/she will be

redirected to the user agreement page.



The screenshot shows the ZyXEL Internet Access Policy page. At the top is the ZyXEL logo. Below it is a link for "View Mobile Version". The main heading is "Internet Access Policy", followed by a note: "(We will provide example for customer within html comment tag)". A red rectangular box highlights a form with the following fields: "Name:" with the value "Charlie", "Phone:" with "032235456", "Address:" with "13, mark St. Sang.TW", and "E-Mail:" with "zyxel-a@gamil.com". Below these is an "Other:" field with "Nothing" and "(Optional)" text. At the bottom of the form are two buttons: "Agree" (highlighted with a red box) and "Disagree".

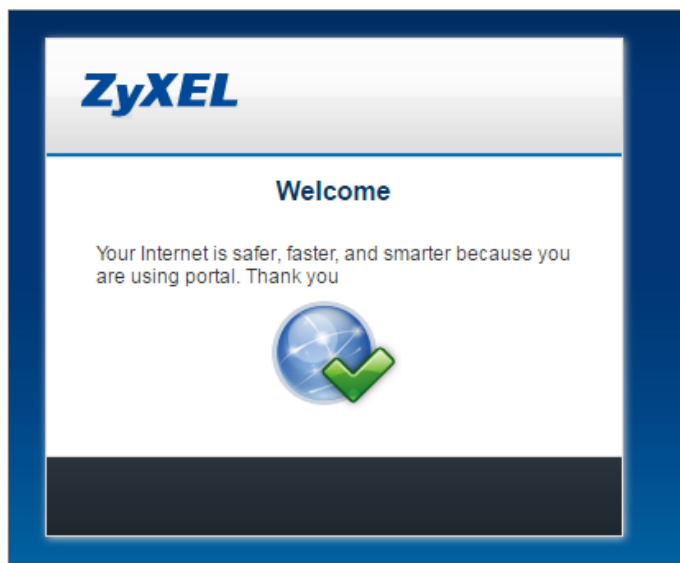

2. The advertisement webpage will be displayed in a new window and it is the first page that appears whenever the user connects to the Internet.

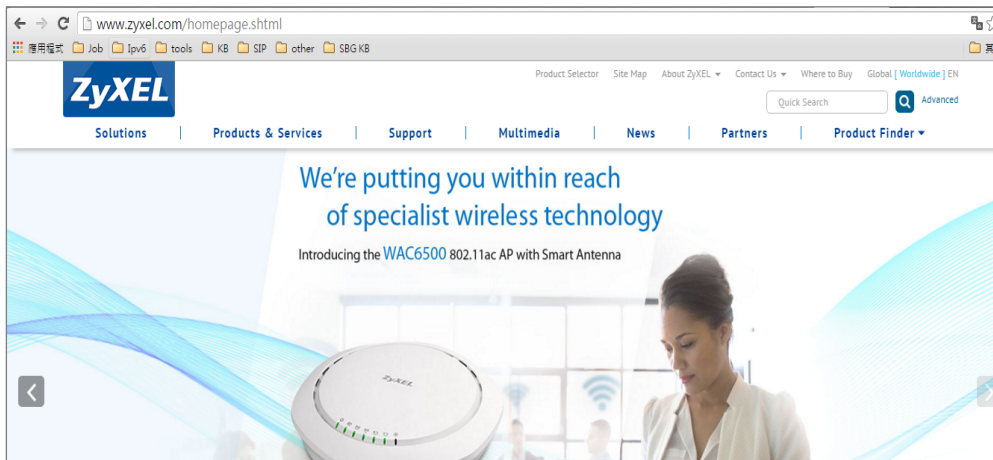

## What could Go Wrong?

If users can access the internet without any Authentication, please make sure the Source Address is configured on the correct the subnet. For example, if you want users to be controlled via authentication in Subnet 192.168.1.0/24, you need to make sure the Source Address should be 192.168.1.0/24

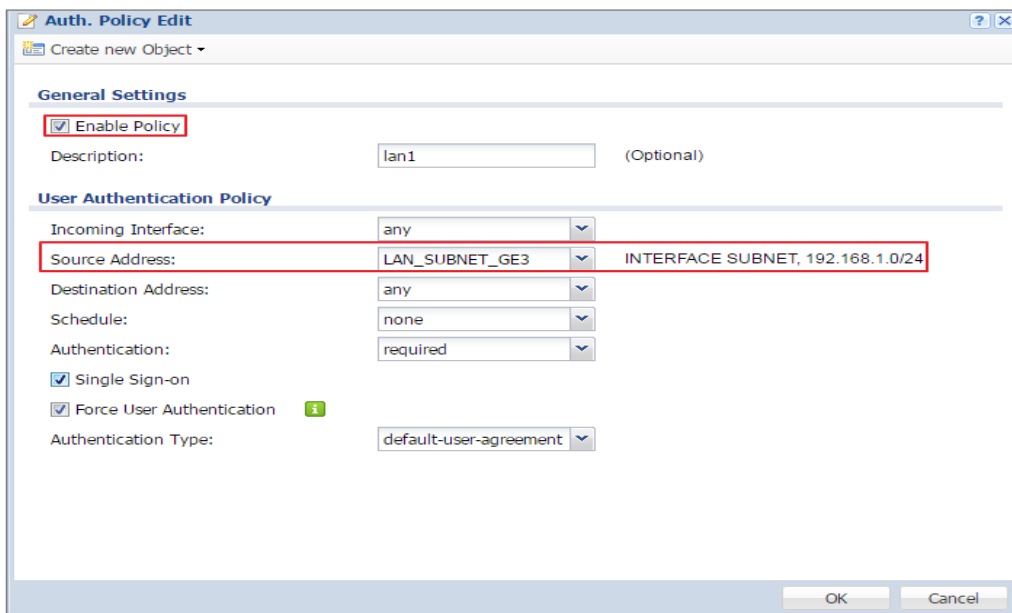

## Set up Enable the Free Time Feature



## Configurations on the USG1100

On the USG1100, you need to enable the SMS service and select **SMS** as the delivery method in the **Free Time** feature.

1. Register for a ViaNett account at <http://www.vianett.com>.

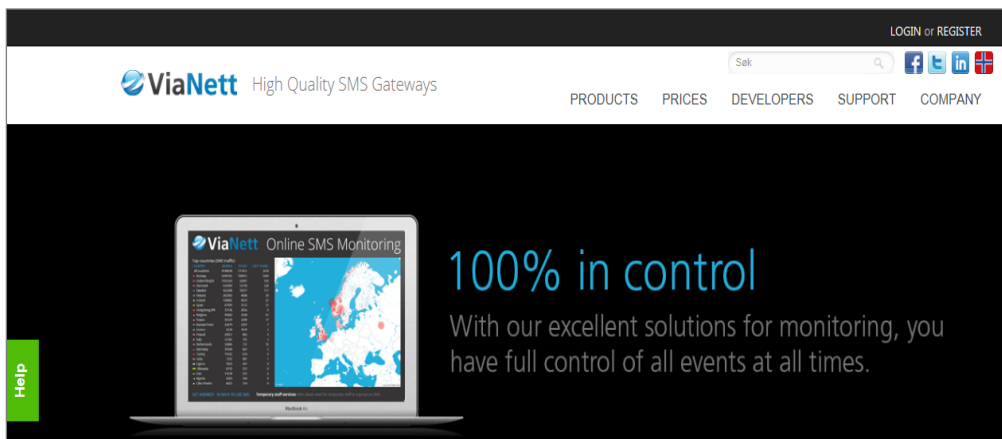

2. Enter all the required information.

A screenshot of the "Free demonstration account" registration form on the ViaNett website. The form is titled "Fill in to get a free account" and is enclosed in a red border. It contains the following fields: "Your name:", "E-mail:", "Mobile number:" (with a "+" sign), "Company name:", "Country:", and "Enter code above:". Below the "Enter code above:" field is a green button labeled "CREATE DEMO ACCOUNT". To the left of the form, there is a list of benefits under "What can we offer?" including "SMS Bulk Worldwide", "Two-way Communication", "SMS Billing Services in the Nordic Countries", "HLR Worldwide", "13 APIs", "Great technical support", "Become a SMS Reseller", and "++".

3. After the form has been submitted, the account information will be sent to your E-mail address.



## Efficiency with SMS

Welcome! We're happy you joined us!

Here is your account information.

**Username** s5553897@gmail.com  
**Password** [REDACTED]  
**Try prefix demo** Send [REDACTED]

[Go to login page](#)

You can send up to 5 SMS messages in the test period, pricegroup and sender address will not be available in this period.

- PURCHASE SMS CREDITS**
- SUB ACCOUNTS
- ADMIN USERS
- COMPANY DATA
- INVOICES (PDF)
- CHANGE PASSWORD

[Service Setup](#)

[Purchase SMS](#)

[>> SMS API](#)

### Purchase SMS credits (Prepaid)

This applies to pre-paid services. Please [contact us](#) if you would like postpaid services.

#### Purchase SMS credits

Company: Zyxel (s5553897@gmail.com)

Amount: EUR 50

Your mobile number (international format): [REDACTED]

Autofill my account when reaching EUR 20

I do accept the [agreement](#) and the [anti-spam statement](#), and that in the event of abuse, my account shall be closed without any refund given for unused credits. The account will be active one year after latest purchase. Unused credits after one year will not be returned.

[GO TO PAYMENT](#)



**Buy now**  
and get started!

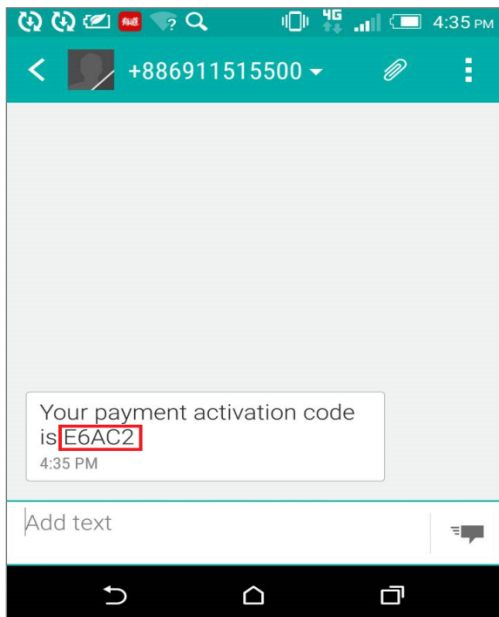

4. Enter the activation code and proceed to make the payment.

Purchase SMS credits (Prepaid)  
This applies to pre-paid services. Please [contact us](#) if you would like postpaid services.

**Purchase SMS credits**

Company: Zyxel (s5553897@gmail.com)

Amount: EUR 20

Your mobile number (international format): [REDACTED]

Autofill my account when reaching EUR 20

I do accept the agreement and the anti-spam statement, and that in the event of abuse, my account shall be closed without any refund given for unused credits. The account will be active one year after latest purchase. Unused credits after one year will not be returned.

**A code is now sent to your mobile.**

Enter the code: E6AC2

**GO TO PAYMENT**

5. Fill-in the credit card information to complete the payment.

The screenshot shows the 'ViaNett Paywiz' payment interface. At the top, the logo and name are displayed. Below, a 'Products' section shows '1 item SMS credits' for '20,00 €'. An 'Information' section lists 'Vendor' details (ViaNett AS, Rabekkgata 9, 1522 Moss, +47 69 20 69 20, smsupport@vianett.no) and 'Customer' details (Zyxel (s5553897@gmail.com)). A 'Credit card' section is highlighted with a red border, containing fields for 'Card type' (with a dropdown and logos for Visa and Mastercard), 'Card number', 'Expiry Date' (with dropdowns for '01' and '2016'), 'CVC', and a 'Complete payment' button.

The payment is complete.

The screenshot shows the 'ViaNett Paywiz' payment interface. At the top, the logo and name are displayed. Below, a 'Products' section shows '1 item SMS credits' for '50,00 €'. An 'Information' section lists 'Vendor' details (ViaNett AS, Rabekkgata 9, 1522 Moss, +47 69 20 69 20, smsupport@vianett.no) and 'Customer' details (Zyxel (s5553897@gmail.com)). A 'Payment' section is highlighted with a red border, containing the text 'Your payment is now complete. Press the link below to return to the store.' and a table with the following data:

Amount:	50,00 €
Order ID:	1124297
Date:	2016-03-16
Transaction ID:	1124297-e58dd87a2dbc4697a8f7a5a6

Below the table is a blue link: [Go back to store](#)

6. After the ViaNett account is ready, go to the USG1100's **Configuration > Hotspot > SMS** screen.

(1) Enable SMS.

(2) Fill-in your local phone country code as the default country code.

(3) Add authentication policy for every source.



7. Go to **Configuration > Hotspot > Free Time**.

(1) Select **Enable Free Time** and set up the free time period. By default, the **Reset Time** is at AM 00:00. You can also set up how many times a MAC address can access the Internet.

(2) Select **SMS** as the method to deliver the login information to the mobile phone.

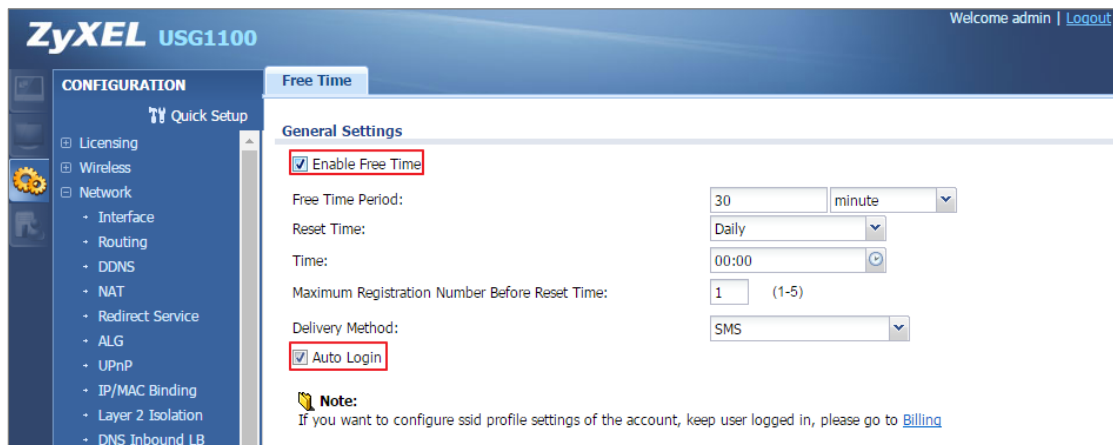

8. Go to **Configuration > Web Authentication**. Select **Enable Web Authentication** and click **Add** in the **Web Authentication Policy Summary** section.

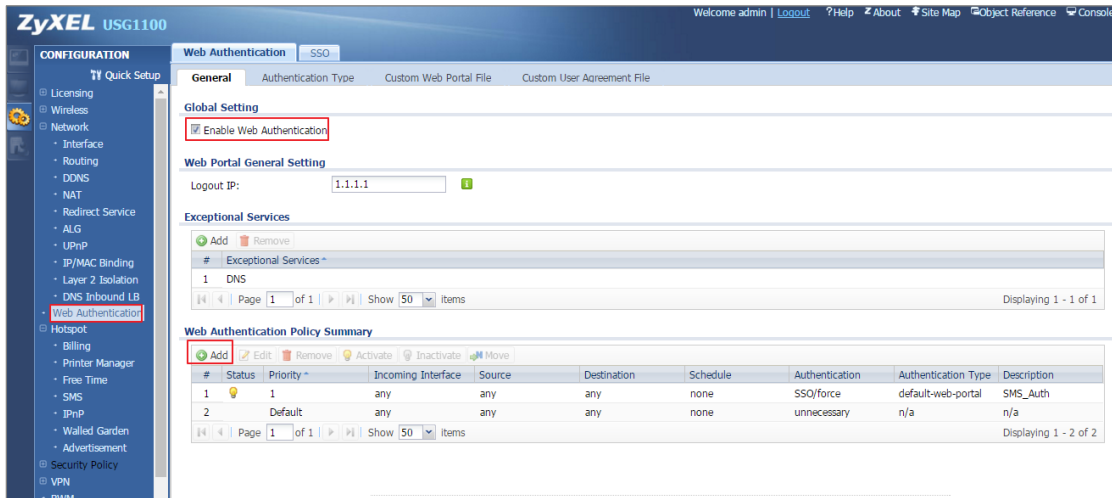

9. Select **Enable Policy, Force User Authentication**, and then select **default-web-portal** as the **Authentication Type**.

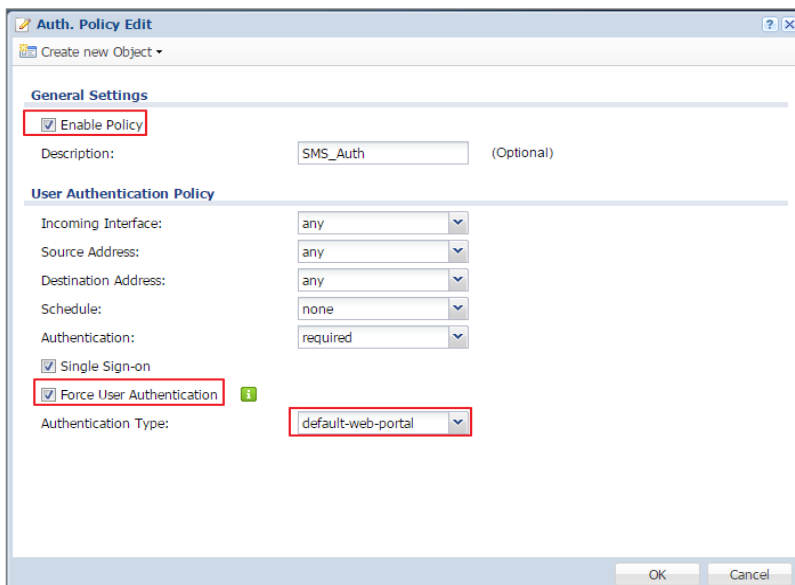

## Test Free Time Feature

1. The user will be redirected to the **Login** screen before he/she is permitted to access the Internet. Click on the link to get a free account.

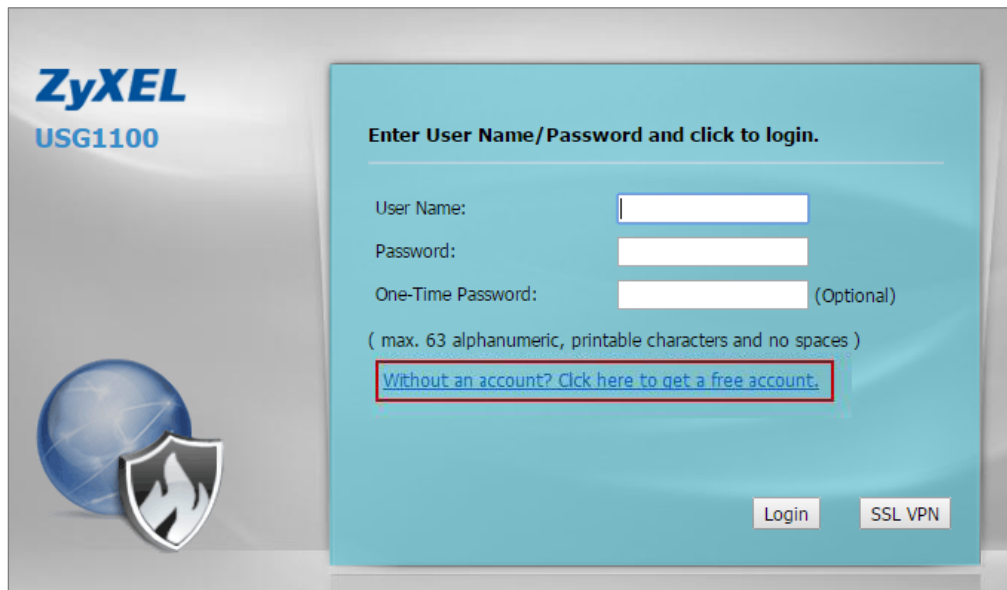

2. Select **Free Time** as the service plan. Then submit your country code and mobile phone number.

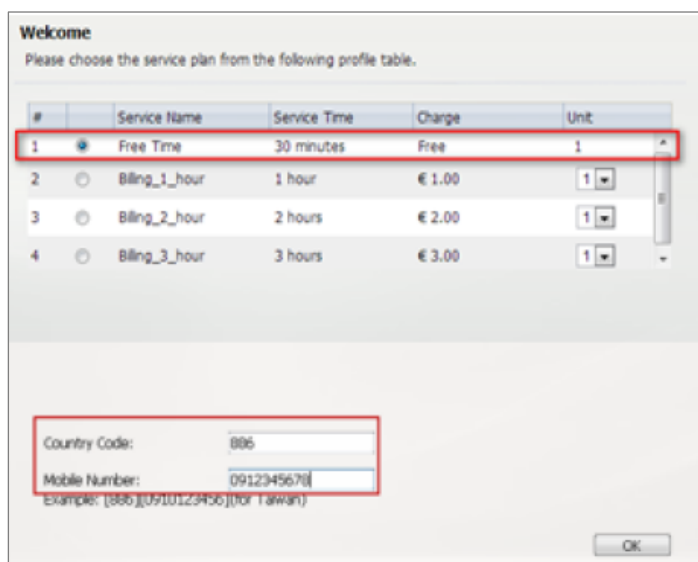

3. The account and password will be sent to your mobile phone.

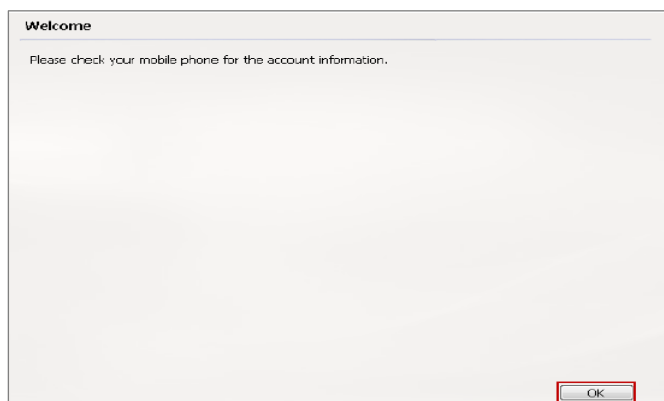

4. Check your account information.

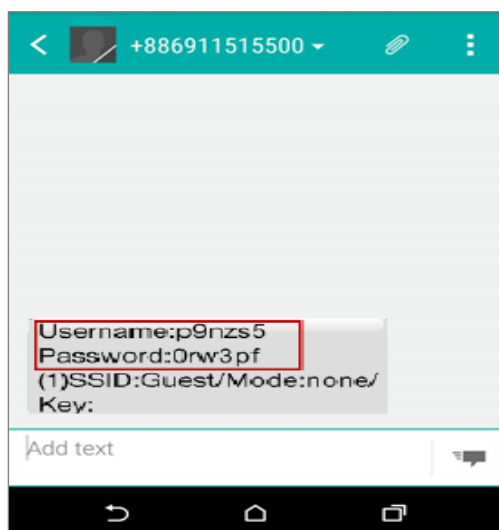

5. Fill-in the account information received on your mobile phone and click **Login**.





The image shows the ZyXEL USG1100 login interface. On the left, there is the ZyXEL logo and the model number USG1100, along with a graphic of a globe and a shield. The main area is a light blue box with the heading "Enter User Name/Password and click to login." Below this, there are three input fields: "User Name:" containing "p9nzs5", "Password:" containing "\*\*\*\*\*", and "One-Time Password:" which is empty and labeled "(Optional)". A note below the fields states "( max. 63 alphanumeric, printable characters and no spaces )" and provides a link: "Without an account? Click here to get a free account." At the bottom right of the form, there are two buttons: "Login" and "SSL VPN".

6. Now the client can start accessing the Internet.

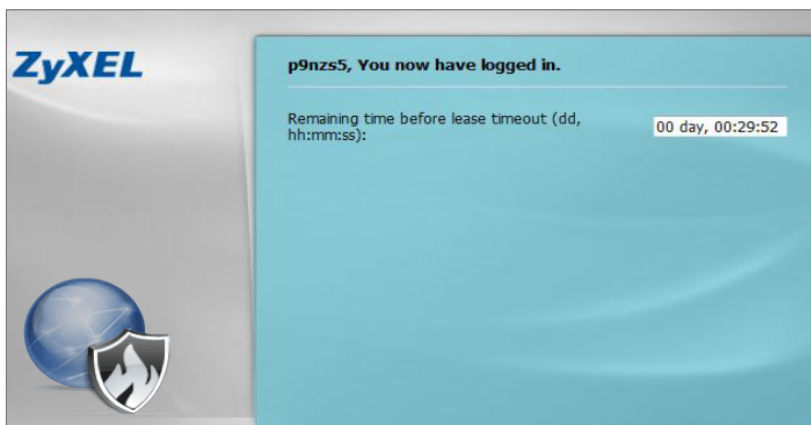

The image shows the ZyXEL USG1100 post-login interface. On the left, there is the ZyXEL logo and the model number USG1100, along with a graphic of a globe and a shield. The main area is a light blue box with the heading "p9nzs5, You now have logged in." Below this, there is a label "Remaining time before lease timeout (dd, hh:mm:ss):" and a digital display showing "00 day, 00:29:52".

## What Can Go Wrong?

If client cannot get the SMS message from ViaNett, please make sure the Country code, Username and Password are all correct.

The image shows a screenshot of the ZyXEL USG1100 web management interface. The page title is "ZyXEL USG1100". On the left, there is a "CONFIGURATION" sidebar with a "Quick Setup" icon and a tree view containing: Licensing, Wireless, Network (with sub-items: Interface, Routing, DDNS, NAT, Redirect Service, ALG, UPnP). The main content area is titled "SMS" and is divided into two sections: "General Settings" and "ViaNett Configuration".

**General Settings**

- Enable SMS
- Default country code for phone number:  (1-4) digit

**ViaNett Configuration**

- User Name:
- Password:
- Retype to Confirm:

## How to Setup IPv6 Interfaces for Pure IPv6 Routing

This example shows how to configure your USG Z's WAN and LAN interfaces which connects two IPv6 networks. USG Z periodically advertises a network prefix of 2006:1111:1111:1111::/64 to the LAN through router advertisements.

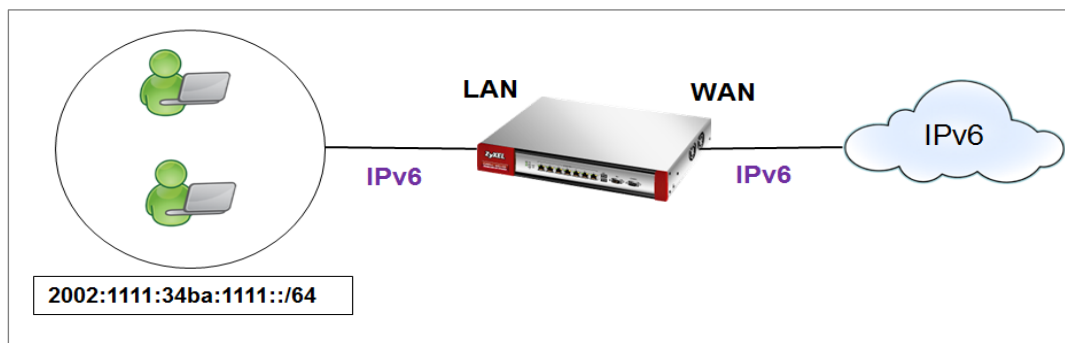

ZyWALL/USG access the internet via IPv6

### Note:

Instead of using router advertisement, you can use DHCPv6 to pass the network settings to the computers on the LAN.

This example was tested using USG110 (Firmware Version: ZLD 4.25) and ZyWALL 310 (Firmware Version: ZLD 4.25).

## Setting Up the IPv6 Interface

### Wan

1. In the CONFIGURATION > Network > Interface > Ethernet screen's IPv6 Configuration section, double-click the wan1.
2. The Edit Ethernet screen appears. Select Enable Interface and Enable IPv6. Select Enable Auto-Configuration. Click OK.

Note: Your ISP or uplink router should enable router advertisement.

**General Settings**

Enable Interface

---

**General IPv6 Setting**

Enable IPv6 i

---

**Interface Properties**

Interface Type:  i

Interface Name:

Port:

Zone:  i

MAC Address:

Description:  (Optional)

---

**IPv6 Address Assignment**

Enable Stateless Address Auto-configuration (SLAAC)

Link-Local Address:

IPv6 Address/Prefix Length:  (Optional)

Advance

---

**DHCPv6 Setting**

DHCPv6:

---

**IPv6 Router Advertisement Setting**

Enable Router Advertisement

Advance

Router Preference:

### Lan

1. In the CONFIGURATION > Network > Interface > Ethernet screen, double-click the lan1 in the IPv6 Configuration section.
2. The Edit Ethernet screen appears. Select Enable Interface and Enable IPv6. Select Enable Router Advertisement and click Add and configure a network prefix for the LAN1 (2006:1111:34ba:1111::/64 in this example). Click **OK**.

**General Settings**

Enable Interface

**General IPv6 Setting**

Enable IPv6 i

**Interface Properties**

Interface Type:  i

Interface Name:

Port: P4

Zone:  i

MAC Address: B8:EC:A3:A9:C0:06

Description:  (Optional)

**IPv6 Address Assignment**

Enable Stateless Address Auto-configuration (SLAAC)

Link-Local Address: n/a

IPv6 Address/Prefix Length:  (Optional)

Advance

**IPv6 Router Advertisement Setting**

Enable Router Advertisement

Advance

Router Preference:

Advance

Advertised Prefix Table

+ Add ✎ Edit ✖ Remove

#	IPv6 Address/Prefix Length
1	2002:1111:34ba:1111::/64

Page 0 of 0 | Show 50 items | No data to display

Advance

3. Using command line ipconfig to check.

```

C:\Windows\system32\cmd.exe
Windows IP Configuration

Wireless LAN adapter Wireless Network Connection:
    Connection-specific DNS Suffix . . . . . : 
    Link-local IPv6 Address . . . . . : fe80::5138:dc32:ff2f:6a34%12
    IPv4 Address . . . . . : 10.251.61.91
    Subnet Mask . . . . . : 255.255.254.0
    Default Gateway . . . . . : 10.251.61.253

Ethernet adapter Local Area Connection:
    Connection-specific DNS Suffix . . . . . : 
    IPv6 Address . . . . . : 2002:1111:34ba:1111:d1b3:8580:1506:4d72
    Temporary IPv6 Address . . . . . : 2002:1111:34ba:1111:5cdd:2779:4c5c:9fe
    Link-local IPv6 Address . . . . . : fe80::d1b3:8580:1506:4d72%11
    IPv4 Address . . . . . : 192.168.2.34
    Subnet Mask . . . . . : 255.255.255.0
    Default Gateway . . . . . : fe80::5ef4:abff:fef9:d4d4%11
    192.168.2.1

Tunnel adapter isatap.{1C5CCB06-45A8-4C5E-AB6A-32D5DE7DA785}:
    Media State . . . . . : Media disconnected
    Connection-specific DNS Suffix . . . . . : 

Tunnel adapter isatap.{7824C2F6-F6C2-4A7C-BBF5-10CF6F23CEE3}:
    Media State . . . . . : Media disconnected
    Connection-specific DNS Suffix . . . . . : 

C:\Users\ZT02340>
    
```

## Set up the Prefix Delegation and Router Advertisement

This example shows how to configure prefix delegation on the ZyWALL's WAN and router advertisement on the LAN.

### Apply a network Prefix From Your ISP

First of all, you have to apply a network prefix from your ISP or the uplink router's administrator. The WAN port's DUID is required when you apply the prefix. You can check the DUID information in the **WAN IPv6 Interface Edit** screen.

This example assumes that you were given a network prefix of 2001:b050:2d::/48 and you decide to divide it and give 2001:b050:2d:1111::/64 to the LAN network. LAN1's IP address is 2001:b050:2d:1111::1/128.

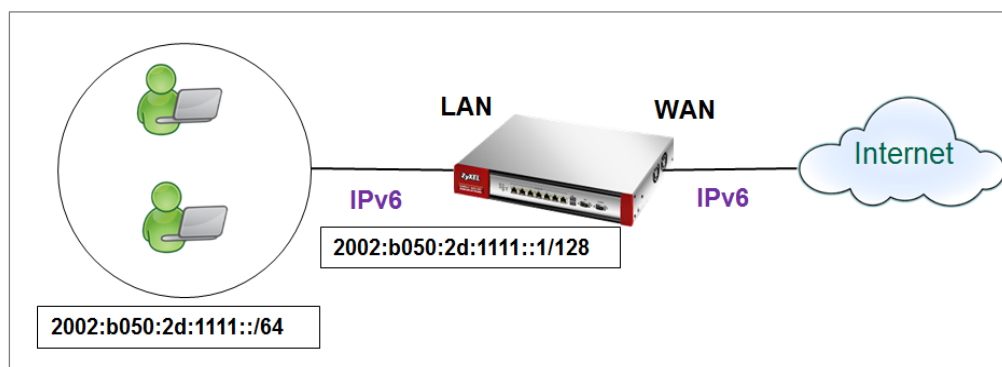

### Setting Up the WAN IPv6 Interface

1. In the **Configuration > Network > Interface > Ethernet** screen's **IPv6 Configuration** section, double-click the **WAN** interface.
2. The Edit Ethernet screen appears. Select Enable Interface and Enable IPv6. Click Create new Object to add a DHCPv6 Request object with the Prefix Delegation type.
  - Select Enable Auto-Configuration.
  - Select Client in the DHCPv6 field. (WAN1's DUID appears.)

Click Add in the DHCPv6 Request Options table and select the DHCPv6 request object you just created. You cannot see the prefix your ISP gave you in the Value field until you click OK and then come back to this screen again. It is 2001:b050:2d::/48 in this example.

Note: Your ISP or a DHCPv6 server in the same network as the WAN should assign an IPv6 IP address for the WAN interface.

**General Settings**

Enable Interface

**General IPv6 Setting**

Enable IPv6 ⓘ

**Interface Properties**

Interface Type: external ⓘ

Interface Name: ge2

Port: P2

Zone: WAN ⓘ

MAC Address: B8:EC:A3:A9:C0:04

Description: (Optional)

**Create new Object**

- DHCPv6 Lease
- DHCPv6 Request**

**Add Request Object**

Name: Prefix\_WAN

Request Type: **Prefix Delegation**

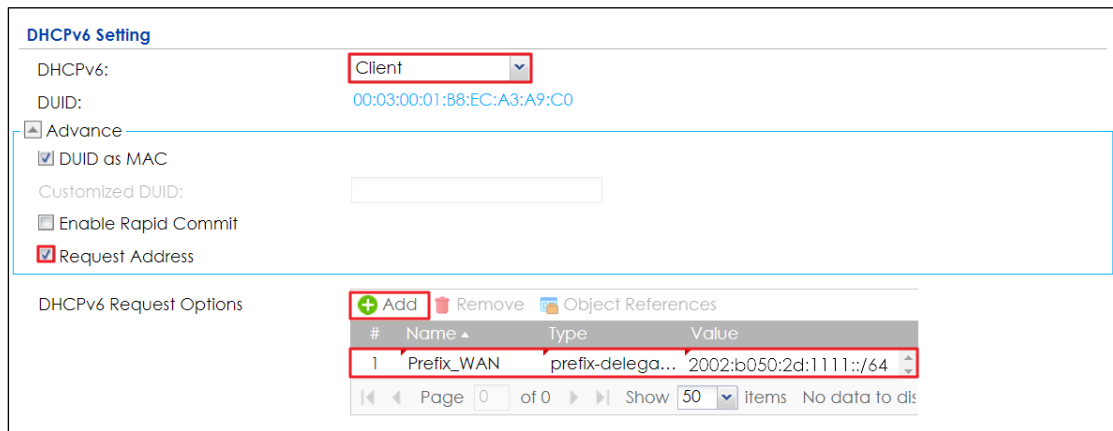

### Setting Up the WAN IPv6 Interface

1. In the Configuration > Network > Interface > Ethernet screen, double-click the lan interface in the IPv6 Configuration section.
2. The Edit Ethernet screen appears. Click Show Advanced Settings to display more settings on this screen.

Select Enable Interface and Enable IPv6.

In the Address from DHCPv6 Prefix Delegation table, click Add and select the DHCPv6 request object from the drop-down list, type ::1111:0:0:1/128 in the Suffix Address field. (The combined address 2001:b050:2d:1111::1/128 will display as LAN1's IPv6 address after you click OK and come back to this screen again).

DHCPv6 Setting is **N/A**

Note: You can configure the IPv6 Address/Prefix Length field instead if the delegated prefix is never changed.

3. In the Advertised Prefix from DHCPv6 Prefix Delegation table, click Add and select the DHCPv6 request object from the drop-down list, type ::1111/64 in the Suffix Address field. (The combined prefix 2001:b050:2d:1111::/64 will display for the LAN1's network prefix after you click OK and come back to this screen again)., please note that this is the USG LAN interface IP.



### General Settings

Enable Interface

---

### General IPv6 Setting

Enable IPv6 i

---

### Interface Properties

Interface Type:  i

Interface Name:

Port: P4

Zone:  i

MAC Address: B8:EC:A3:A9:C0:06

Description:  (Optional)

### IPv6 Address Assignment

Enable Stateless Address Auto-configuration (SLAAC)

Link-Local Address: n/a

IPv6 Address/Prefix Length:  (Optional)

Advance

Gateway:  (Optional)

Metric:  (0-15)

Address from DHCPv6 Prefix Delegation

+ Add ✎ Edit ✖ Remove 📄 Object References

#	Delegated Prefix	Suffix Address	Address
1	Prefix_WAN	::1111:0:0:1/64	2002:b050:2d:1111

Page 0 of 0 Show 50 items No data to display

1. Navigate to IPv6 Router Advertisement Setting, enable Router Advertisement, it would advertise the prefix to the Lan host, also enable Advertised Hosts Get Other Configuration From DHCPv6, Lan hosts will get the DNS address from USG.
2. Configure Advertised Prefix from DHCPv6 Prefix Delegation, the Lan hosts will get the Prefix from USG, Suffix address can set 0~F

**IPv6 Router Advertisement Setting**

Enable Router Advertisement

Advance

Advertised Hosts Get Network Configuration From DHCPv6

Advertised Hosts Get Other Configuration From DHCPv6

Router Preference:

Advance

MTU:  (1280-1500, 0 is disabled)

Hop Limit:  (0-255, 0 is disabled)

Advertised Prefix Table

+ Add Edit Remove

#	IPv6 Address/Prefix Length
Page 0 of 0 Show 50 items No data to dis	

Advance

Advertised Prefix from DHCPv6 Prefix Delegation

+ Add Edit Remove Object References

#	Delegated Prefix	Suffix Address	Address
1	Prefix_WAN	::0/64	
Page 0 of 0 Show 50 items No data to dis			

## Test

1. Connect a computer to the ZyWALL's LAN interface.
2. Enable IPv6 support on you computer.
  - In Windows XP, you need to use the IPv6 install command in a Command Prompt.
  - In Windows 7, IPv6 is supported by default. You can enable IPv6 in the Control Panel > Network and Sharing Center > Local Area Connection screen.
3. Your computer should get an IPv6 IP address (starting with 2001:b050:2d:1111: for this example) from the ZyWALL.

```

ca: C:\Windows\system32\cmd.exe
Windows IP Configuration

Ethernet adapter Local Area Connection:

    Connection-specific DNS Suffix . : 
    IPv6 Address . . . . . : 2002:b050:2d:1111:d1b3:8580:1506:4d72
    Temporary IPv6 Address . . . . . : 2002:b050:2d:1111:94c1:10c5:a323:cc97
    Link-local IPv6 Address . . . . . : fe80:d1b3:8580:1506:4d72%11
    IPv4 Address . . . . . : 192.168.100.35
    Subnet Mask . . . . . : 255.255.255.0
    Default Gateway . . . . . : fe80::5ef4:abff:fef9:d4d3%11
                                192.168.100.1

Tunnel adapter isatap.{7824C2F6-F6C2-4A7C-BBF5-10CP6F23CEE3}:

    Media State . . . . . : Media disconnected
    Connection-specific DNS Suffix . : 
  
```

4. Open a web browser and type <http://www.kame.net>. If your IPv6 settings are correct, you can see a dancing turtle in the website.

## What Can Go Wrong?

1. If you forgot to enable Auto-Configuration on the WAN1 IPv6 interface, you will not have any default route to forward the LAN's IPv6 packets.
2. To use prefix delegation, you must set the WAN interface to a DHCPv6 client, enable router advertisements on the LAN interface as well as configure the Advertised Prefix from DHCPv6 Prefix Delegation table.
3. If the Value field in the WAN1's DHCPv6 Request Options table displays n/a, contact your ISP for further support.
4. In Windows, some IPv6 related tunnels may be enabled by default such as Teredo and 6to4 tunnels. It may cause your computer to handle IPv6 packets in an unexpected way. It is recommended to disable those tunnels on your computer.

## Assign the DNS address to the client

1. If you want to assign the DNS server address instead of ISP's , then please create the DNS server object.

Select DHCPv6 Lease and DNS server as lease type. For example set the Google DNS IPv6 address 2001:4860:4860::8888

**+ Add Lease Object**

Name:

Lease Type:

Advance

DNS Server:

User Defined Address:

OK Cancel

2. Select the drop-down list DHCPv6 as server type, add the DNS server object in DHCPv6 lease options and enable **Router Advertisement**.

**IPv6 Router Advertisement Setting**

Enable Router Advertisement

Advance

Advertised Hosts Get Network Configuration From DHCPv6

Advertised Hosts Get Other Configuration From DHCPv6

Router Preference:

Advance

MTU:  (1280-1500, 0 is disabled)

Hop Limit:  (0-255, 0 is disabled)

Advertised Prefix Table

#	IPv6 Address/Prefix Length
No data to display	

Advance

Advertised Prefix from DHCPv6 Prefix Delegation

#	Delegated Prefix	Suffix Address	Address
1	Prefix_WAN	::0/64	

## Test

You can use command "netsh interface ipv6 show dnsservers" to check the DNS server IP.

```

C:\Windows\system32\cmd.exe
Windows IP Configuration

Ethernet adapter Local Area Connection:

    Connection-specific DNS Suffix . . . : 
    IPv6 Address . . . . . : 2002:b050:2d:1111:d1b3:8580:1506:4d72
    Temporary IPv6 Address . . . . . : 2002:b050:2d:1111:94c1:10c5:a323:cc97
    Link-local IPv6 Address . . . . . : fe80::d1b3:8580:1506:4d72%11
    IPv4 Address . . . . . : 192.168.100.35
    Subnet Mask . . . . . : 255.255.255.0
    Default Gateway . . . . . : fe80::5ef4:abff:fef9:d4d3%11
    192.168.100.1

Tunnel adapter isatap.<7824C2F6-F6C2-4A7C-BBF5-10CF6F23CEE3>:

    Media State . . . . . : Media disconnected
    Connection-specific DNS Suffix . . . : 

C:\Users\ZT02340>netsh interface ipv6 show dnsservers

Configuration for interface "Local Area Connection"
    DNS servers configured through DHCP: 2001:4860:4860::8888
    Register with which suffix: Primary only

Configuration for interface "Loopback Pseudo-Interface 1"
    Statically Configured DNS Servers: fec0:0:0:ffff::1%1
    fec0:0:0:ffff::2%1
    fec0:0:0:ffff::3%1
    Register with which suffix: Primary only

Configuration for interface "isatap.<7824C2F6-F6C2-4A7C-BBF5-10CF6F23CEE3>"
    Statically Configured DNS Servers: None
    Register with which suffix: None
    
```

## How to Perform and Use the Packet Capture Feature on the ZyWALL/USG

This example shows how to use the Packet Capture feature to capture network traffic going through the ZyWALL/USG's interfaces. Studying these packet captures may help you identify network problems.

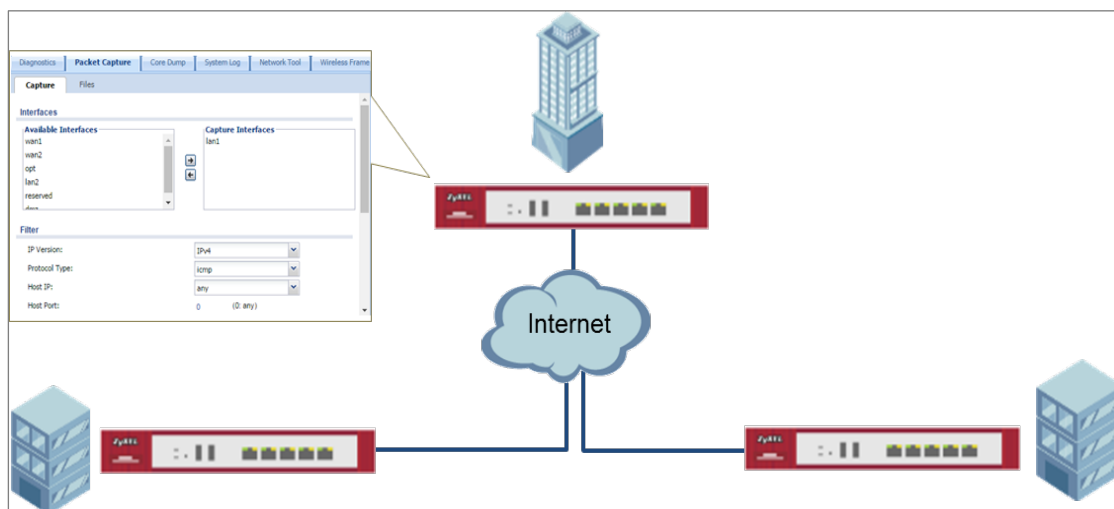

ZyWALL/USG Packet Capture Feature Settings

 Note: New capture files overwrite existing files of the same name. Change the File Suffix field's setting to avoid this. This example was tested using USG110 (Firmware Version: ZLD 4.25).

## Set Up the Packet Capture Feature

**8** Go to **MAINTENANCE > Diagnostics > Packet Capture > Capture > Interfaces**. Select interfaces for which to capture packets and click the right arrow button to move them to the **Capture Interfaces** list.

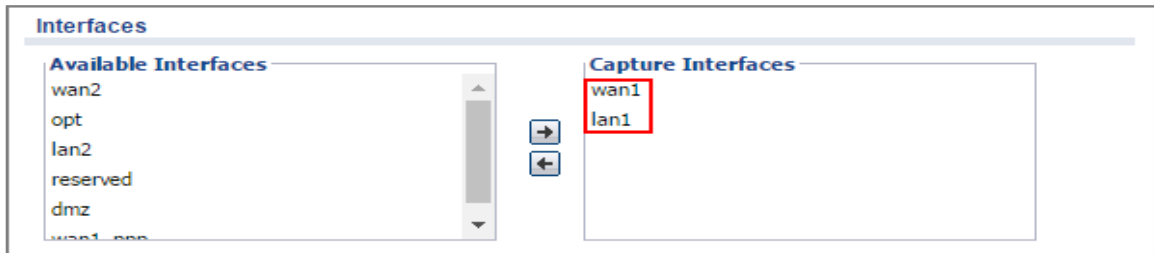

9 Go to **MAINTENANCE > Diagnostics > Packet Capture > Capture > Filter.**

Select **IP Version** (IPv4 or IPv6) for which to capture packets or select **any** to capture packets for all IP versions.

Select the **Protocol Type** of traffic for which to capture packets. Select **any** to capture packets for all types of traffic.

Select a **Host IP** address object for which to capture packets. Select **any** to capture packets for all hosts. Select **User Defined** to be able to enter an IP address.

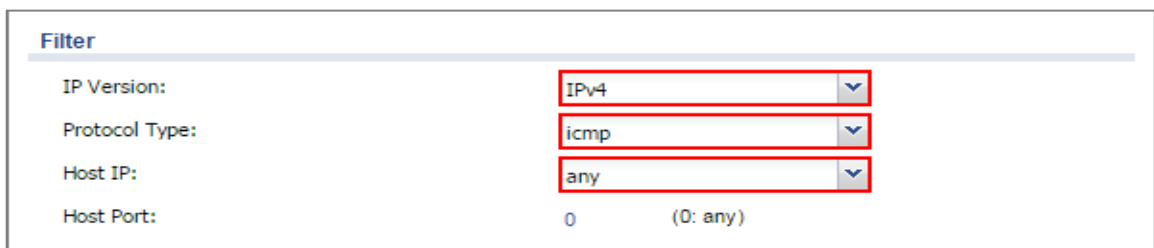

10 Go to **MAINTENANCE > Diagnostics > Packet Capture > Capture > Misc setting.**

Select **Continuously capture and overwrite old ones** to have the ZyWALL/USG keep capturing traffic and overwriting old packet capture entries when the available storage space runs out. Select **Save data to onboard storage only** or **Save data to USB storage** (If status shows service deactivated, go to **CONFIGURATION > Object > USB Storage**, select Activate USB storage service)

**Misc setting**

Continuously capture and overwrite old ones

Save data to onboard storage only (available: 65 MB)

Save data to USB storage (available: 895 MB)

Captured Packet Files:  MB

Split threshold:  MB

Duration:  (0: unlimited)

File Suffix:

Number Of Bytes To Capture (Per Packet):  Bytes

11 Click **Capture**.

**Interfaces**

**Available Interfaces**

- wan2
- opt
- lan2
- reserved
- dmz
- wan1

**Capture Interfaces**

- lan1
- wan1

**Filter**

IP Version:

Protocol Type:

Host IP:

Host Port:  (0: any)

**Misc setting**

Continuously capture and overwrite old ones

Save data to onboard storage only (available: 65 MB)

**Capture** **Stop** **Reset**

12 Click **Stop** when collection is done.



### Interfaces

**Available Interfaces**

- wan2
- opt
- lan2
- reserved
- dmz
- wan1

➔

➜

**Capture Interfaces**

- lan1
- wan1

---

### Filter

IP Version: IPv4

Protocol Type: icmp

Host IP: any

Host Port: 0 (0: any)

---

### Misc setting

Continuously capture and overwrite old ones

Save data to onboard storage only (available: 65 MB)

Capture
Stop
Reset

## Check the Capture Files

- 1 Go to **MAINTENANCE > Diagnostics > Packet Capture > Files**, select the .cap file and click **Download**.

Capture
**Files**

### Captured Packet Files

Remove
Download

#	File Name	Size	Last Modified
1	lan1--packet-capture.00000.cap	924	2016-06-27 18:28:17
2	lan1--packet-capture.txt	78	2016-06-27 18:28:17
3	wan1--packet-capture.00000.cap	24	2016-06-27 18:28:17
4	wan1--packet-capture.txt	76	2016-06-27 18:28:17

Page 1 of 1
Show 50 items
Displaying 1 - 4 of 4

- 2 Open .cap files with Wireshark

lan1--packet-capture.00000.cap [Wireshark 1.12.5 (v1.12.5-0-g5819e5b from master-1.12)]

File Edit View Go Capture Analyze Statistics Telephony Tools Internals Help

Filter: Expression... Clear Apply Save

No.	Time	Source	Destination	Protocol
1	2016-06-27 18:37:53.799645	192.168.1.33	8.8.8.8	ICMP
2	2016-06-27 18:37:53.825728	8.8.8.8	192.168.1.33	ICMP
3	2016-06-27 18:37:54.800399	192.168.1.33	8.8.8.8	ICMP
4	2016-06-27 18:37:54.826398	8.8.8.8	192.168.1.33	ICMP
5	2016-06-27 18:37:55.803515	192.168.1.33	8.8.8.8	ICMP
6	2016-06-27 18:37:55.829523	8.8.8.8	192.168.1.33	ICMP

File: "C:\Users\ZT01896\Downloads\lan1--... Packets: 6 · Displayed: 6 (100.0%) · Lo... Profile: Default

wan1--packet-capture.00000.cap [Wireshark 1.12.5 (v1.12.5-0-g5819e5b from master-1.12)]

File Edit View Go Capture Analyze Statistics Telephony Tools Internals Help

Filter: Expression... Clear Apply Save

No.	Time	Source	Destination	Protocol
1	2016-06-27 18:37:53.799825	111.250.188.9	8.8.8.8	ICMP
2	2016-06-27 18:37:53.825643	8.8.8.8	111.250.188.9	ICMP
3	2016-06-27 18:37:54.800473	111.250.188.9	8.8.8.8	ICMP
4	2016-06-27 18:37:54.826341	8.8.8.8	111.250.188.9	ICMP
5	2016-06-27 18:37:55.803606	111.250.188.9	8.8.8.8	ICMP
6	2016-06-27 18:37:55.829421	8.8.8.8	111.250.188.9	ICMP

File: "C:\Users\ZT01896\Downloads\wan1... Packets: 6 · Displayed: 6 (100.0%) · Lo... Profile: Default

## How to Automatically Reboot the ZyWALL/USG by Schedule

This example shows how to use shell script and schedule run to reboot device automatically for maintenance purpose.

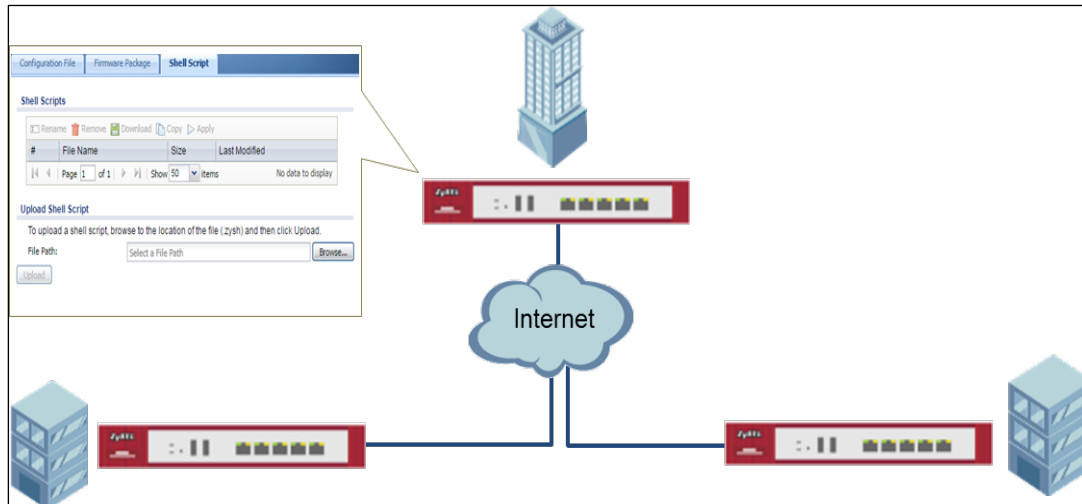

## ZyWALL/USG Auto Schedule Reboot Settings

 Note: This example was tested using USG110 (Firmware Version: ZLD 4.25).

## Set Up the Shell Script

- 1 Run Windows Notepad application and input below command:

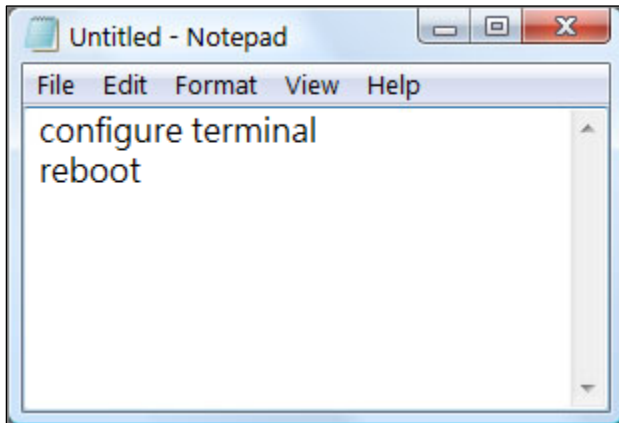

2 Save this file as "reboot\_device.zysh"

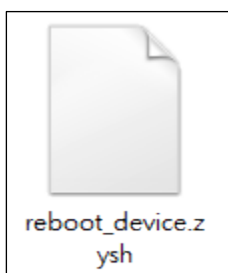

3 In the ZyWALL/USG, go to **MAINTENANCE > File Manager > Shell Script**. Click **Browse...** to find the reboot\_device.zysh file. Click **Upload** to begin the upload process.

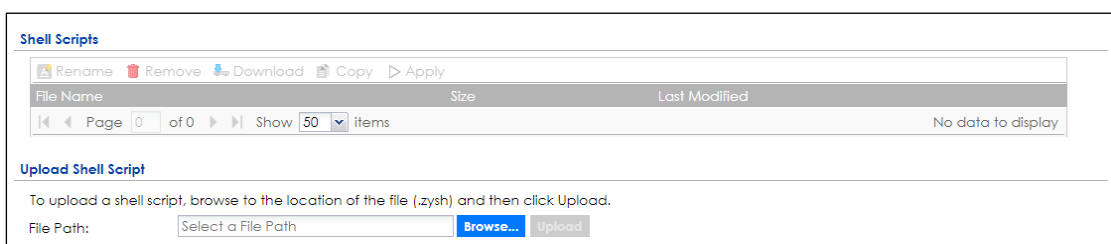

## Set Up the Schedule Run

1 Login the device via console/telnet/SSH (using PuTTY in this example)

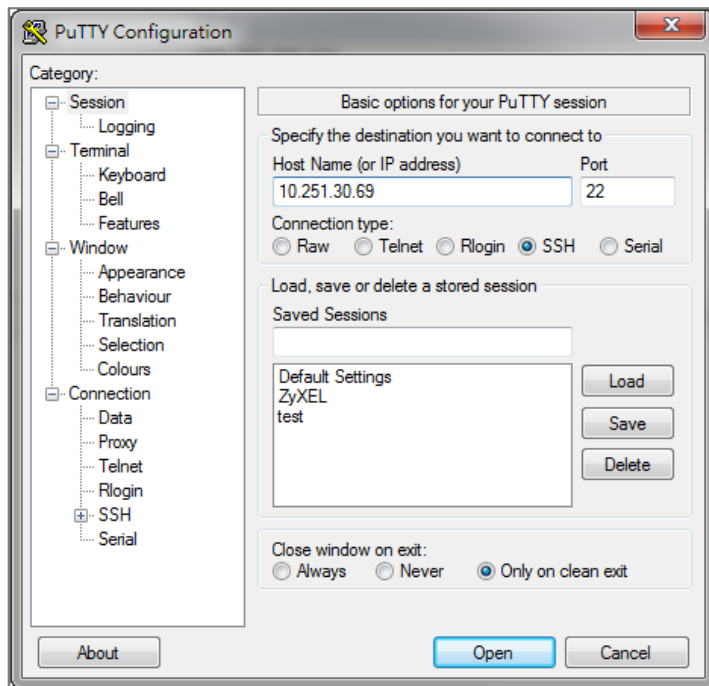

2 Issuing below commands based on three different (daily, weekly and monthly) user scenarios:

a. Router(config)# schedule-run 1 reboot\_device.zysh daily 10:00

(The device will reboot at 10:00 everyday)

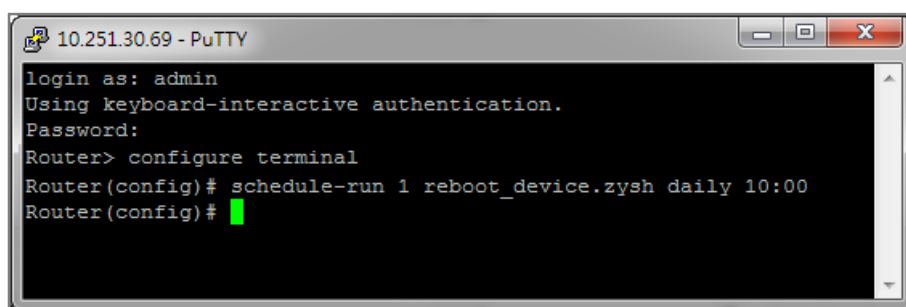

b. Router(config)# schedule-run 1 reboot\_device.zysh weekly 10:00 sun

(The device will reboot at 10:00 every Sunday)

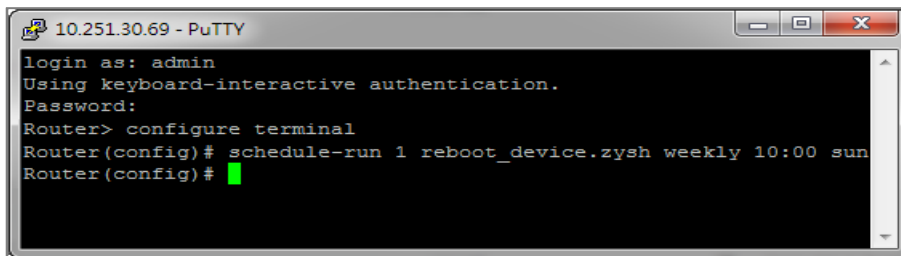

```
10.251.30.69 - PuTTY
login as: admin
Using keyboard-interactive authentication.
Password:
Router> configure terminal
Router(config)# schedule-run 1 reboot_device.zysh weekly 10:00 sun
Router(config)#
```

- c. Router(config)# schedule-run 1 reboot\_device.zysh monthly 10:00 23  
(The device will reboot at 10:00 every month on 23th)

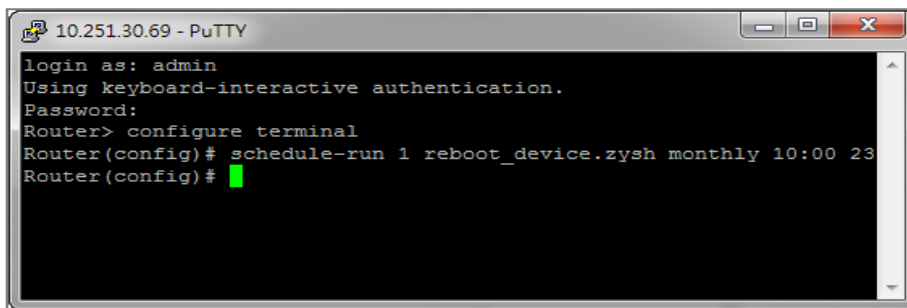

```
10.251.30.69 - PuTTY
login as: admin
Using keyboard-interactive authentication.
Password:
Router> configure terminal
Router(config)# schedule-run 1 reboot_device.zysh monthly 10:00 23
Router(config)#
```

## Check the Reboot Status

- 3 Login the device via console/telnet/SSH, the reboot runs as scheduled

- 4 Go to **Configuration > System > Date/Time**, check **Current Date/Time**.

Figure Configuration > System > Date/Time

Date/Time	
<b>Current Time and Date</b>	
Current Time:	13:47:47 UTC+08:00
Current Date:	2017-06-29

## How To Schedule YouTube Access

This is an example of using the ZyWALL/USG UTM Profile and Security Policy to control access to the network. If an application should not have network access during certain hours, you can use Application Patrol, SSL Inspection and Schedule settings to make sure that these applications cannot access the Internet.

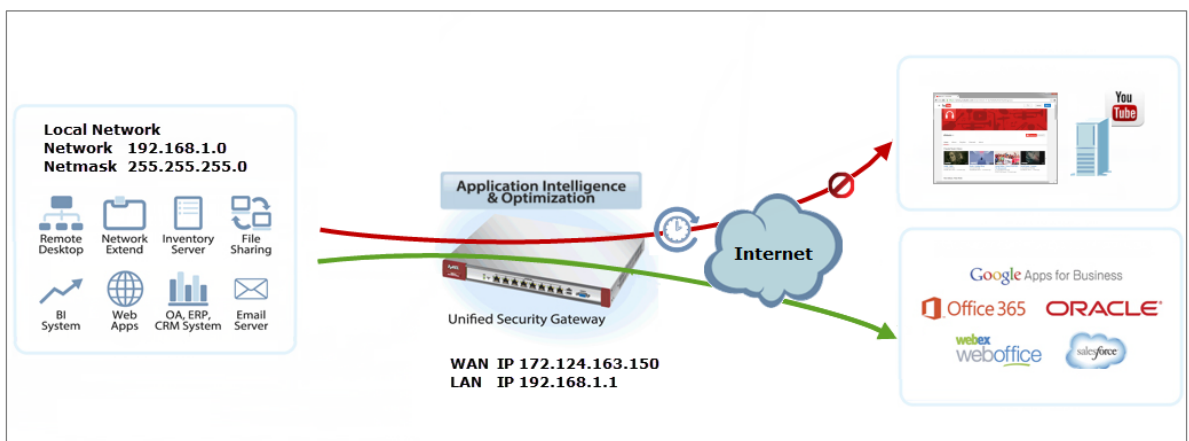

ZyWALL/USG with Scheduled YouTube Access Settings Example

 Note: All network IP addresses and subnet masks are used as examples in this article. Please replace them with your actual network IP addresses and subnet masks. This example was tested using USG310 (Firmware Version: ZLD 4.25).

## Set Up the Schedule on the ZyWALL/USG

In the ZyWALL/USG, go to **CONFIGURATION > Object > Schedule > Recurring > Add Schedule Recurring Rule**. Configure a **Name** for you to identify the **Schedule Recurring Rule**. Specify the **Day Time** hour and minute when the schedule begins and ends each day. In the **Weekly** schedule, select each day of the week that the recurring schedule is effective.

**CONFIGURATION > Object > Schedule > Recurring**



**Configuration**

Name:

**Day Time**

Start Time:

Stop Time:

**Weekly**

Week Days:  Monday  Tuesday  Wednesday  
 Thursday  Friday  Saturday  
 Sunday

## Create the Application Objects on the ZyWALL/USG

In the ZyWALL/USG, go to **CONFIGURATION > Object > Application > Add Application Rule**. Configure a **Name** for you to identify the **Application Profile**. Then, click **Add** to create an **Application Object**.

**CONFIGURATION > Object > Application > Add Application Rule**

In the **Application Object**, select **By Service**, type a keyword and click **Search** to display all signatures containing that keyword. Check all **Query Result** and Click **OK**.

**CONFIGURATION > Object > Application > Add Application Rule > Add Application Object**

## Set Up SSL Inspection on the ZyWALL/USG

In the ZyWALL/USG, go to **CONFIGURATION > UTM Profile > SSL Inspection > Add rule**, configure a **Name** for you to identify the **SSL Inspection** profile.

Then, select the **CA Certificate** to be the certificate used in this profile. Select **Block** to **Action for Connection with SSL v3** and select **Log** type to be **log alert**. Leave other actions as default settings.

**CONFIGURATION > UTM Profile > SSL Inspection > Add rule**

General Settings			
Name:	Youtube_Profile		
Description:			
CA Certificate:	default		
SSL/TLS version supported minimum:	ssl3	Log:	log alert
Action for connection with unsupported suit:	pass	Log:	no
Action for connection with untrusted cert chain:	pass	Log:	log

## Set Up the Security Policy on the ZyWALL/USG

In the ZyWALL/USG, go to **CONFIGURATION > Security Policy > Policy Control**, configure a **Name** for you to identify the **Security Policy** profile. For **From** and **To** policies, select the direction of travel of packets to which the policy applies. Select the **Schedule** that defines when the policy applies (Youtube\_Schedule in this example).

Scroll down to **UTM Profile**, check **Application Patrol** and select a profile from the list box (Youtube\_profile in this example). Then, check **SSL Inspection** and select a profile from the list box (Youtube in this example).

**CONFIGURATION > Security Policy > Policy Control**

<input checked="" type="checkbox"/> Enable		
Name:	Youtube_Schedule	
Description:		(Optional)
From:	LAN1	
To:	any (Excluding zyx)	
Source:	any	
Destination:	any	
Service:	any	
User:	any	
Schedule:	Youtebe_Schedule	
Action:	allow	
Log matched traffic:	no	

UTM Profile				
<input type="checkbox"/>	Content Filter:	none	Log:	by profile
<input checked="" type="checkbox"/>	SSL Inspection:	Youtube_Profile	Log:	by profile

## Export Certificate from ZyWALL/USG and Import it to Windows 7 Operation System

When SSL inspection is enabled and an access website does not trust the ZyWALL/USG certificate, the browser will display a warning page of security certificate problems.

Go to ZyWALL/USG **CONFIGURATION > Object > Certificate > default > Edit** to export default certificate from ZyWALL/USG with Private Key (zyx123 in this example).

**CONFIGURATION > Object > Certificate > default**

My Certificates Setting						
#	Name	Type	Subject	Issuer	Valid From	Valid To
1	default	SELF	CN=vpn300_B8ECA3A9C...	CN=vpn300_B8ECA3A9C...	2017-04-25 12:41:25 GMT	2027-04-23 12:41:25 GMT

Page 1 of 1 | Show 50 Items | Displaying 1 - 1 of 1

**CONFIGURATION > Object > Certificate > default > Edit > Export Certificate with Private Key**

**Edit My Certificates**

Issuer: CN=vpn300\_B8ECA3A9C003

Signature Algorithm: rsa-pkcs1-sha256

Valid From: 2017-04-25 12:41:25 GMT

Valid To: 2027-04-23 12:41:25 GMT

Key Algorithm: rsaEncryption (2048 bits)

Subject Alternative Name: vpn300\_B8ECA3A9C003

Key Usage: DigitalSignature, KeyEncipherment, DataEncipherment, KeyCertSi

Extended Key Usage:

Basic Constraint: Subject Type=CA, Path Length Constraint=1

MD5 Fingerprint: 1b:a9:ff:f3:e6:42:44:9c:90:8d:bc:3e:f9:07:af:26

SHA1 Fingerprint: 1b:dd:6e:b2:c7:89:2e:ea:43:a0:ee:d2:55:3a:ff:15:89:bc:64:70

**Certificate in PEM (Base-64) Encoded Format**

```
-----BEGIN X509 CERTIFICATE-----
MIIDSzCCAjOgAwIBAgIJAP0XXinyW6C/MA0GCSqGSIb3DQEBCwUAMB4xHDAaBgNV
BAMME3ZwbjMwMF9COEVDQTNBOUMwMDMwHhcNMTcwNDI1MTI0MTI1WhcNMjcw
NDIz
```

Password:

Save default certificate as \*.p12 file to Windows 7 Operation System.



default.p12

In Windows 7 Operating System **Start Menu > Search Box**, type **mmc** and press **Enter**.

**Start Menu > Search Box > mmc**

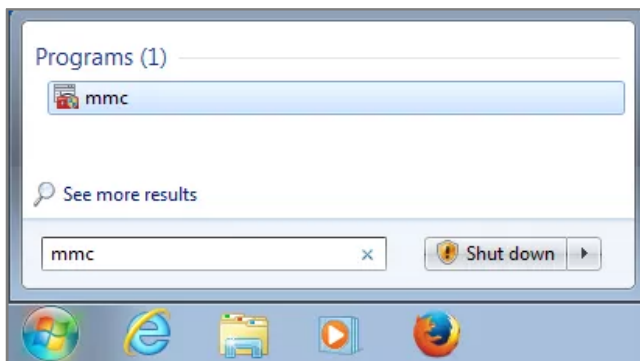

In the mmc console window, click **File > Add/Remove Snap-in...**

**File > Add/Remove Snap-in...**

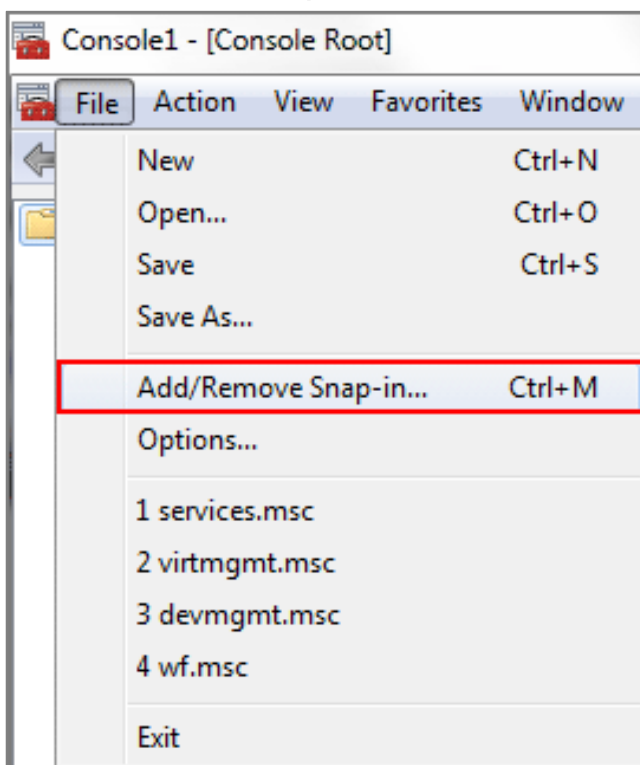

In the **Available snap-ins**, select the **Certificates** and click **Add** button. Select **Computer account > Local Computer**. Then, click **Finished** and **OK** to close the **Snap-ins** window.

## Available snap-ins > Certificates > Add

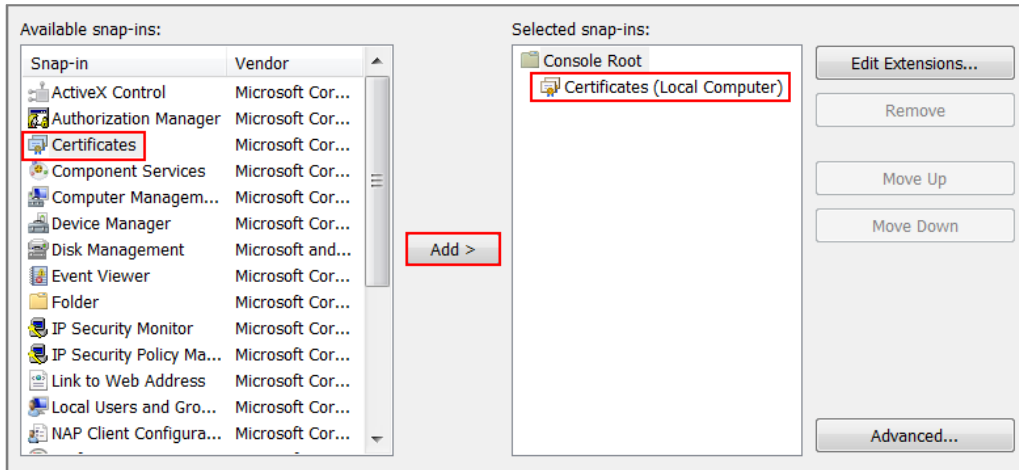

In the mmc console window, open the **Certificates (Local Computer) > Trusted Root Certification Authorities**, right click **Certificate > All Tasks > Import...**

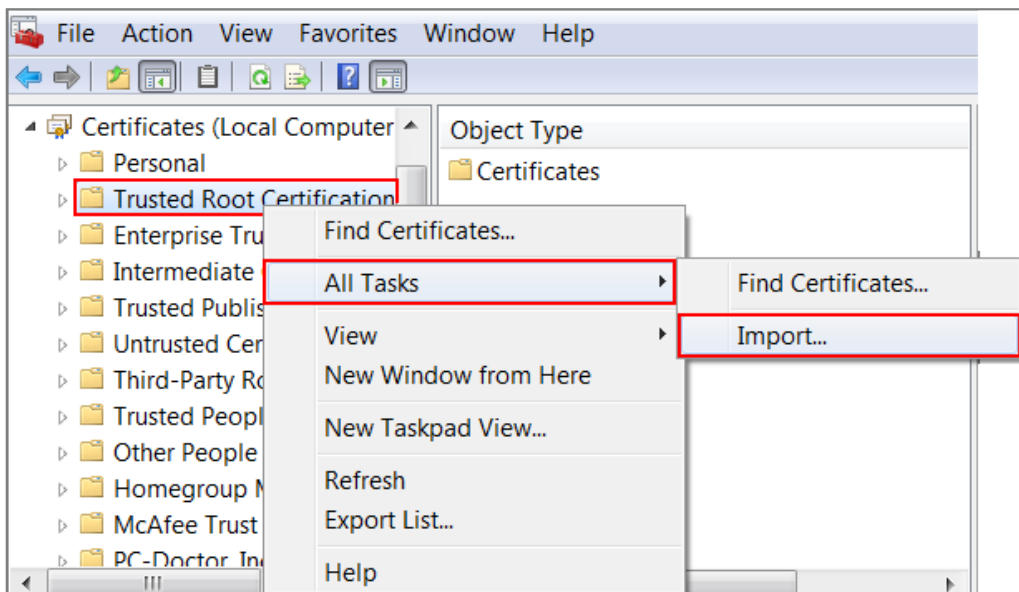

Click **Next**, Then, **Browse...**, and locate the .p12 file you downloaded earlier. Then, click **Next**.

**File to Import**  
Specify the file you want to import.

---

File name:

Note: More than one certificate can be stored in a single file in the following formats:

- Personal Information Exchange- PKCS #12 (.PFX,.P12)
- Cryptographic Message Syntax Standard- PKCS #7 Certificates (.P7B)
- Microsoft Serialized Certificate Store (.SST)

Click **Next**, type **zyx123** in the **Password** field and click **Next** again

**Password**  
To maintain security, the private key was protected with a password.

---

Type the password for the private key.

Password:

Enable strong private key protection. You will be prompted every time the private key is used by an application if you enable this option.

Mark this key as exportable. This will allow you to back up or transport your keys at a later time.

Include all extended properties.

Select **Place all certificates in the following store** and then click **Browse** and find **Trusted Root Certification Authorities**. Click **Next**, then click **Finish**.

**Certificate Store**  
Certificate stores are system areas where certificates are kept.

---

Windows can automatically select a certificate store, or you can specify a location for the certificate.

Automatically select the certificate store based on the type of certificate

Place all certificates in the following store

Certificate store:

 Note: Each ZyWALL/USG device has its own self-signed certificate by factory default. When you reset to the default configuration file, the original self-signed certificate is erased, and a new self-signed certificate will be created when the ZyWALL/USG boots the next time.



## Test the Result

Type <http://www.youtube.com/> or <https://www.youtube.com/> into the browser.  
An error message occurs.

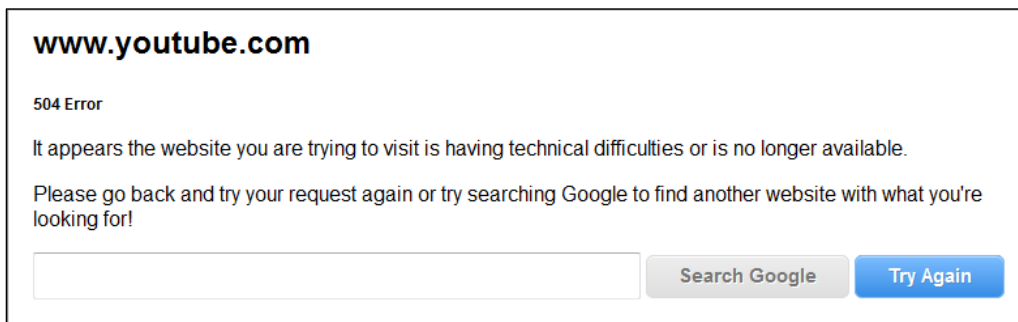

Go to the ZyWALL/USG **Monitor > Log**, you will see [alert] log message such as below.

Priority	Category	Message	Note
alert	Application Patrol	Rule_id=1 SSI=Y App=[Streaming Media]Youtube.access Action=reject SID=67137542	ACCESS BLOCK
alert	Application Patrol	Rule_id=1 SSI=Y App=[Streaming Media]Youtube.access Action=reject SID=67137542	ACCESS BLOCK

## What Could Go Wrong?

If you are not be able to configure any **Application Patrol** policies or it's not working, there are two possible reasons:

You have not subscribed for the **Application Patrol** service.

You have subscribed for the **Application Patrol** service but the license is expired.

You can click the link from the **CONFIGURATION > Licensing > Registration** screen of your ZyXEL device's Web Configurator or click the myZyXEL.com 2.0 icon from

the portal page (<https://portal.myzyxel.com/>) to register or extend your

**Application Patrol** license.

After you apply the **Application Patrol** service, the running session will continue till it's finished.

## How to continuously run a ZySH script

This example shows how to use shell script and continuously run a ZySH script automatically for maintenance purpose.

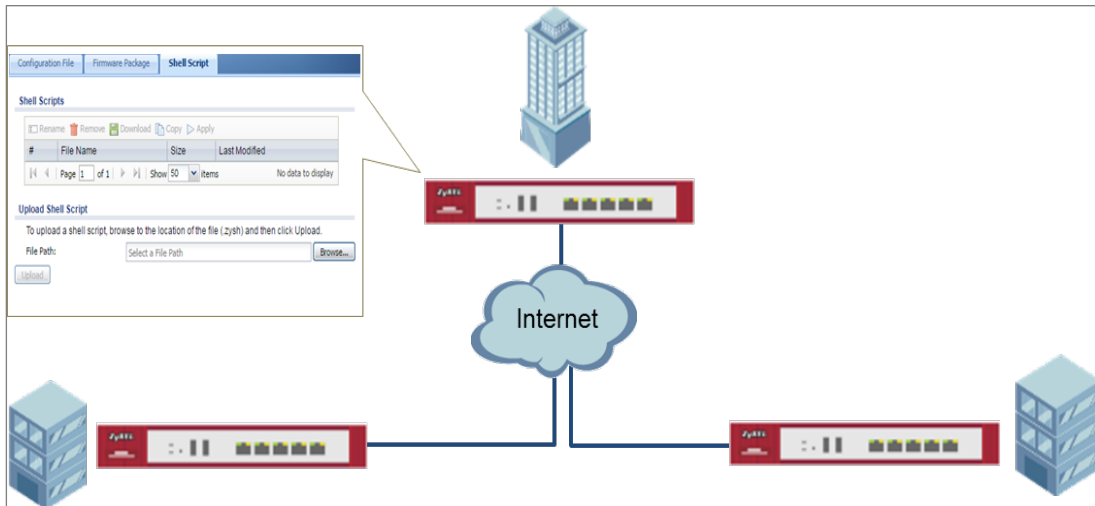

ZyWALL/USG continuously run a ZySH script Settings

 Note: This example was tested using USG110 (Firmware Version: ZLD 4.25).

## Set Up the Shell Script

- 1 Run Windows Notepad application and input below command:

```
Untitled - Notepad
File Edit Format View Help
configure terminal
no firewall activate
schedule-run 1 enable_firewall.zysh daily 02:00
```

- 2 Save this file as "disable\_firewall.zysh"

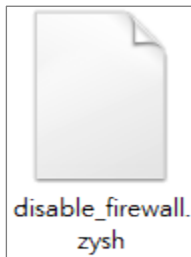

- 3 Run Windows Notepad application and input below command:

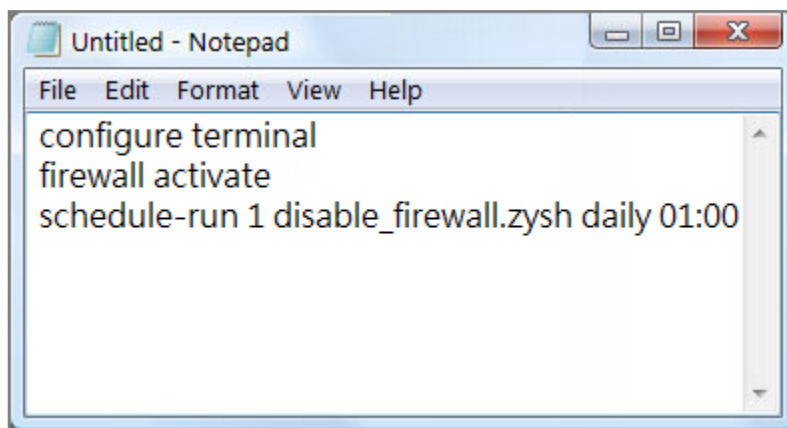

- 4 Save this file as "enable\_firewall.zysh"

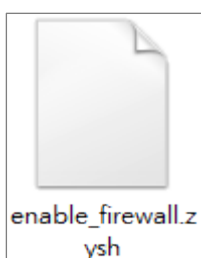

- 5 In the ZyWALL/USG, go to **MAINTENANCE > File Manager > Shell Script**. Click **Browse...** to find the disable\_firewall.zysh and enable\_firewall.zysh file. Click **Upload** to begin the upload process.

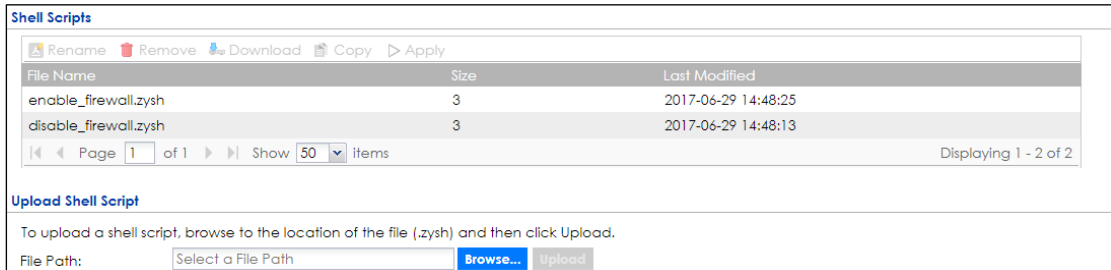

## Set Up the Schedule Run

6 Issuing below commands:

```
Router> configure terminal
```

```
Router(config)# schedule-run 1 disable_firewall.zysh daily 15:15
```

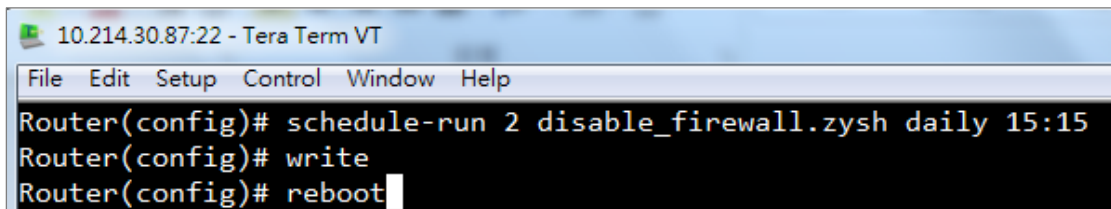

## Check the Result

1 In the ZyWALL/USG, go to **DASHBOARD**.

### DASHBOARD



## How To Register Your Device and Services at myZyXEL.com

myZyXEL.com is ZyXEL's online services center where you can register your ZyXEL device and manage subscription services available for the device. To update signature files or use a subscription service, you have to register the device and activate the corresponding service at myZyXEL.com.

MyZyXEL.com 2.0 Management Architecture

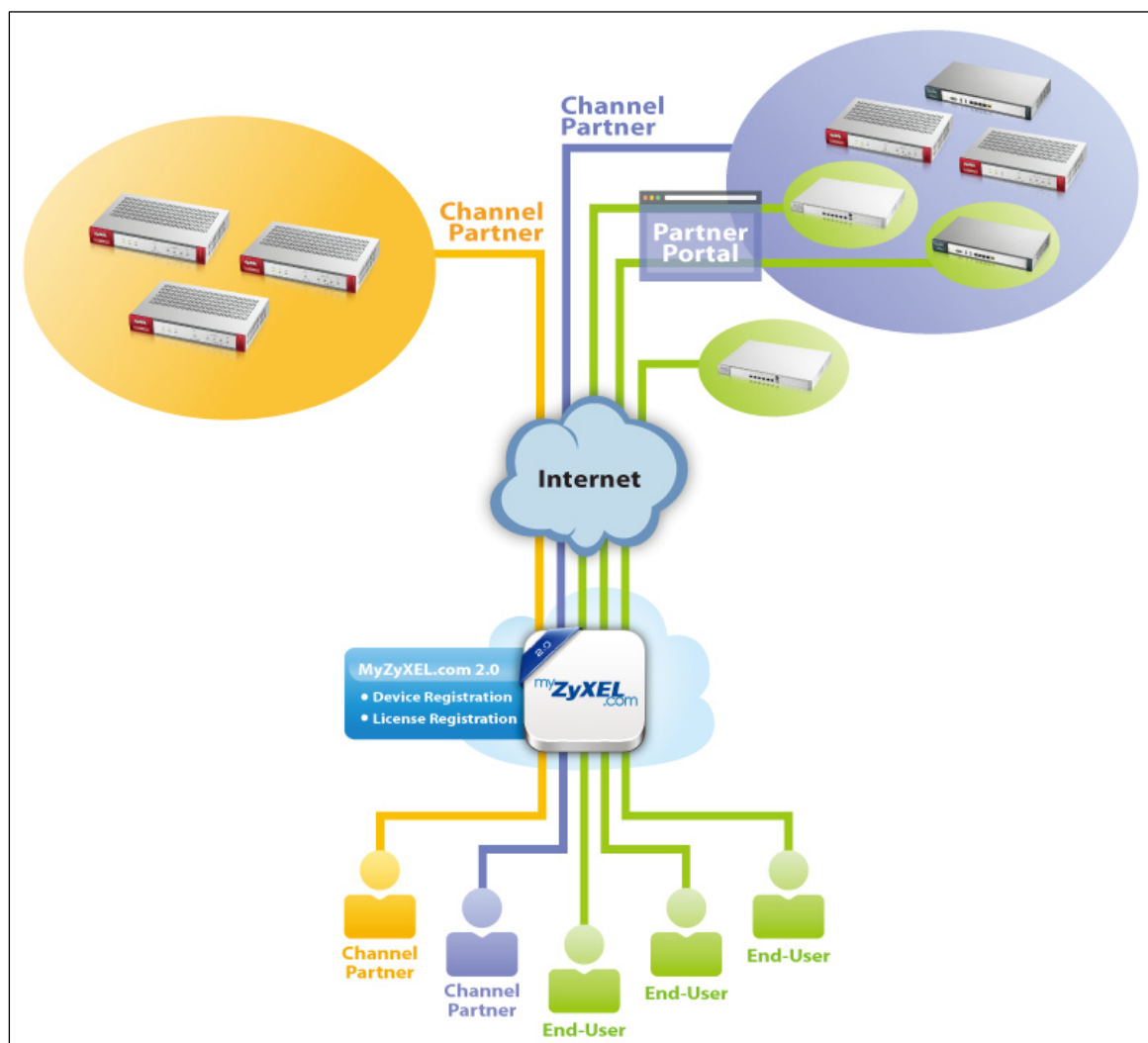

## Account Creation

After you click the link from the **Registration** screen of your ZyXEL device's Web Configurator or click **the myZyXEL.com 2.0** icon from the portal page (<https://portal.myzyxel.com/>), the **Sign In** screen displays.

### CONFIGURATION > Licensing > Registration

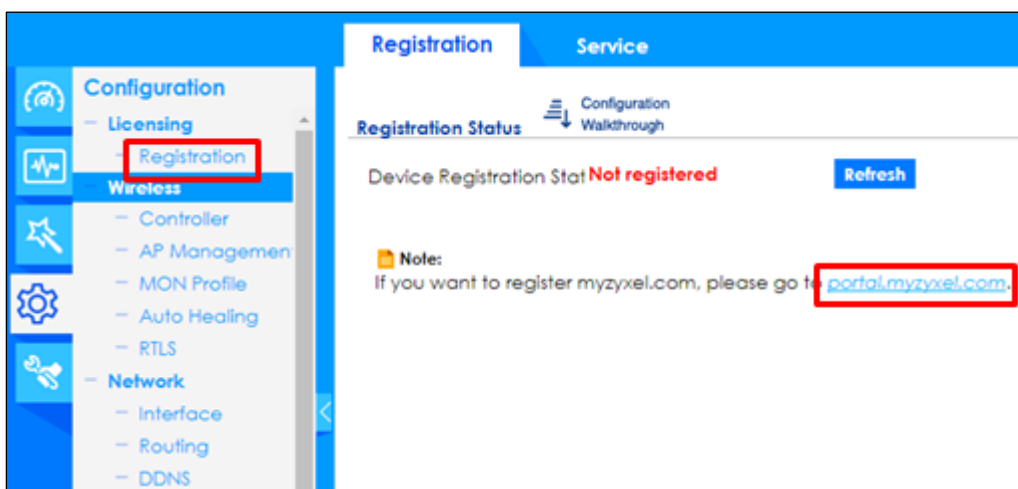

Click **Not a Member Yet** to open the **Sign Up** screen where you can create an account.

## myZyXEL.com > Not a Member Yet

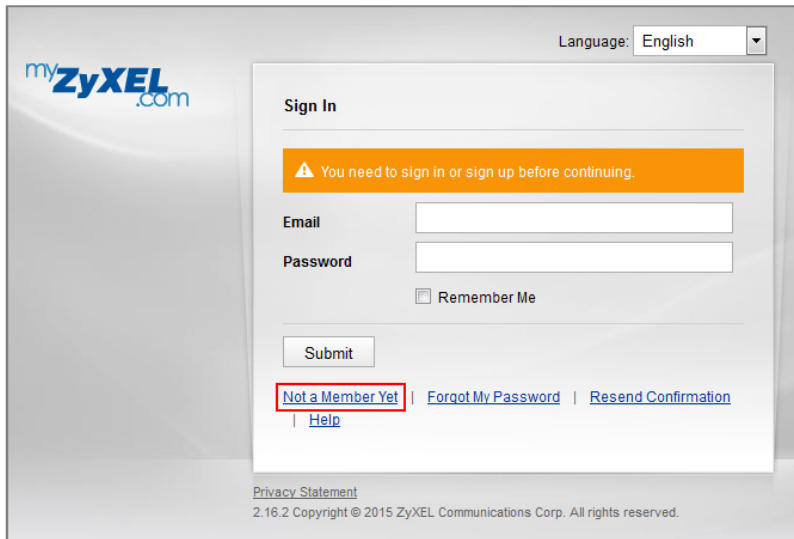

Select Registration Type to create an Individual account or a Business account. Individual account is for non-commercial, end user of ZyXEL products. Business account is for commercial users; VAT # is required (the requirement varies in selection of different countries)

## myZyXEL.com > Not a Member Yet > Sign-up

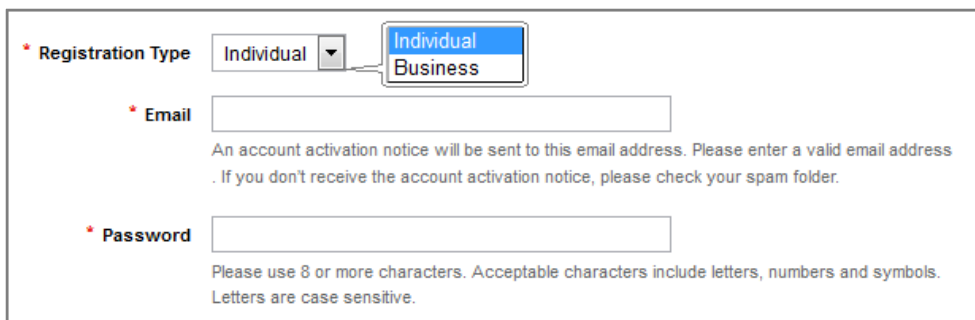

 Note: The business account can be changed into a channel partner account by an administrator. With a channel partner account, you can register multiple devices and/or services at a time and check service status reports. Contact your sales representative to have a channel partner account.





The screenshot shows the 'myZyXEL.com' interface. On the left is a navigation menu with the following items: Dashboard, Device Management, Service Management, Maintenance Management (with a sub-item License Check), Device Registration (highlighted with a red box), and Service Registration. The main content area is titled 'Device Registration' and contains the following fields: 'Product Select' (a dropdown menu set to 'Device'), 'MAC Address' (a text input field with a red border and a sample value 'i.e. 20:13:10:00:00:A0'), 'Serial Number' (a text input field with a red border), 'Name' (a text input field with a placeholder 'Enter a name for this device (optional)'), and 'Reseller' (a text input field with a 'Check' button next to it and a placeholder 'Enter the email address, VAT number or company name of the reseller selling you the device.'). At the bottom of the form are 'Submit' and 'Cancel' buttons.

## Service Registration (In the Case of Standard License)

Click **Service Registration** in the navigation panel to open the screen. Fill in the **License Key** as shown on **E-iCard License**.

The screenshot shows the 'myZyXEL.com' interface. On the left is a navigation menu with the following items: Dashboard, Device Management, Service Management, Maintenance Management (with a sub-item License Check), Device Registration, and Service Registration (highlighted with a red box). The main content area is titled 'Service Registration' and contains a single text input field for 'License Key' with a red border. At the bottom of the form are 'Submit' and 'Cancel' buttons.

Go to the **Service Management** page and click the **Link** button. Select the device then click the **Activate** button to initiate the services license. You will get a **Service Activation Notice** Email when you activate a new service.

**Service Management**

Product Select  Search

License Key	Name	Type	Amount/Time	Linked Device	Status
S-CCF001-7B2655063E2A...	Content Filter_Commtouch	Standard	731 / 731 days	<a href="#">Link</a>	Available
	Kaspersky Anti-Virus_Trial	Trial	30 / 30 days	00:00:AA:80:38:15	<input type="button" value="Activate"/>
	Anti-Spam_Trial	Trial	30 / 30 days	00:00:AA:80:38:15	<input type="button" value="Activate"/>
	IDP_Trial	Trial	253 / 253 days	00:00:AA:80:38:15	<input type="button" value="Activate"/>

## Device Management (In the Case of Registering Bundled Licenses)

Go to **Device Management** and click on the **MAC Address** hyper link of your device. In the **Linked Services** page, click the **Activate** button to initiate the services license. You will get a **Service Activation Notice** Email when you activate a new service.

**Device Management**

Product Select  Search

Model	MAC Address	Linked Services	Registration Time	Status	Link to CF Report
ZyWALL 110	<a href="#">00:00:AA:80:38:15</a>	<ul style="list-style-type: none"> <li>IDP</li> <li>Anti-Spam</li> <li>Kaspersky Anti-Virus</li> <li>Content Filter</li> </ul>	2014-08-07 12:44	Active	<input type="button" value="Link"/>

**Linked Services**

Name	Remaining Amount / Period	Total Licensed Amount / Period	Trial	Status
IDP_Standard	397 days	397 days	Standard	<input type="button" value="Activate"/>
Anti-Spam_Standard	397 days	397 days	Standard	<input type="button" value="Activate"/>
Kaspersky Anti-Virus_Standard	397 days	397 days	Standard	<input type="button" value="Activate"/>
Content Filter_Standard	397 days	397 days	Standard	<input type="button" value="Activate"/>

## Refresh Service

After service activated, please go to the ZyWALL/USG **CONFIGURATION** >

**Licensing** > **Registration** > **Service** and click the **Service License Refresh** button to update the **Status**.

License Status					
#	Service	Status	Registration Type	Expiration Date	Count
1	IDP/AppPatrol Signature Service	Licensed	Standard	2016-7-2	N/A
2	Anti-Virus Signature Service	Licensed	Standard	2016-7-2	N/A
3	Anti-Spam Service	Licensed	Standard	2016-7-2	N/A
4	Content Filter Service	Licensed	Standard	2016-7-2	N/A
5	SSL VPN Service	Licensed			255
6	Managed AP Service	Default	Standard		2

Page 1 of 1 | Show 50 items | Displaying 1 - 6 of 6

---

License Refresh

**Service License Refresh**

## What Could Go Wrong?

If you can't activate your device's service license, please check if you entered a correct license key. Or your login session connecting to the device's Web GUI or to myZyXEL.com might have been timed out. Please try to login again.

If the device fails to register and connect to myzyxel.com, please ensure that the WAN interface IP address can public access to Internet is working properly.

If you forget your password of myzyxel.com account, please click the "Forgot My Password" link on the login screen and enter your email address. MyZyXEL.com 2.0 will send an email to you with a link to change your password.



Dear Customer,

You have requested to reset your myZyXEL.com password. Please click the following link to change your password.  
[https://portal.myzyxel.com/users/password/edit?reset\\_password\\_token=1fwwdWf9gpc27m-CeQm43](https://portal.myzyxel.com/users/password/edit?reset_password_token=1fwwdWf9gpc27m-CeQm43)

**\*\*This is an automatically generated email, please do not reply\*\***

Best Regards,  
myZyXEL.com Administrator  
ZyXEL Communications Corp.  
[info@myzyxel.com](mailto:info@myzyxel.com)

If you forget your registered email address on myZyXEL.com, please go to the link below and submit a request to ZyXEL support team for further support:

[http://www.zyxel.com/form/Support\\_Feedback.shtml](http://www.zyxel.com/form/Support_Feedback.shtml)

## How To Exempt Specific Users From Security Control

This is an example of using a ZyWALL/USG Security Policy to exempt three corporate executives from security control, while controlling Internet access for other employees' accounts.

Exempt Specific Users from Security Control Example

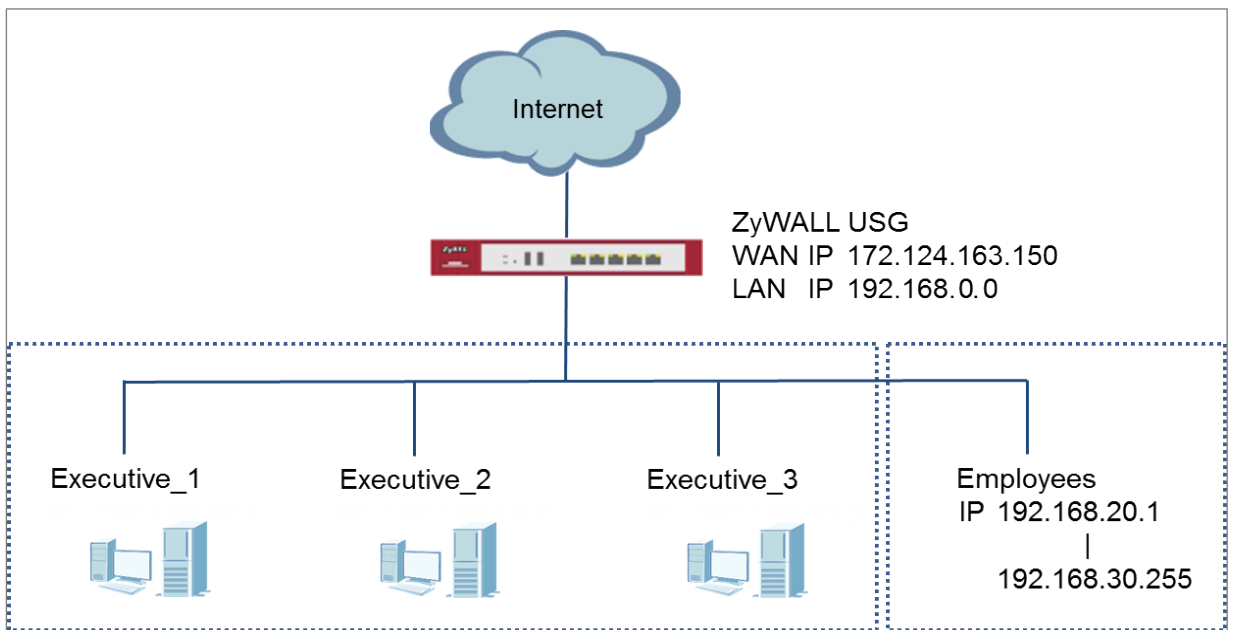

 Note: All network IP addresses and subnet masks are used as examples in this article. Please replace them with your actual network IP addresses and subnet masks. This example was tested using USG310 (Firmware Version: ZLD 4.25).

## Set Up the Security Policy on the ZyWALL/USG for Employees

In the ZyWALL/USG, go to **CONFIGURATION > Object > Address > Add Address Rule** to create address range for employees.

**CONFIGURATION > Object > Address > Add Address Rule**

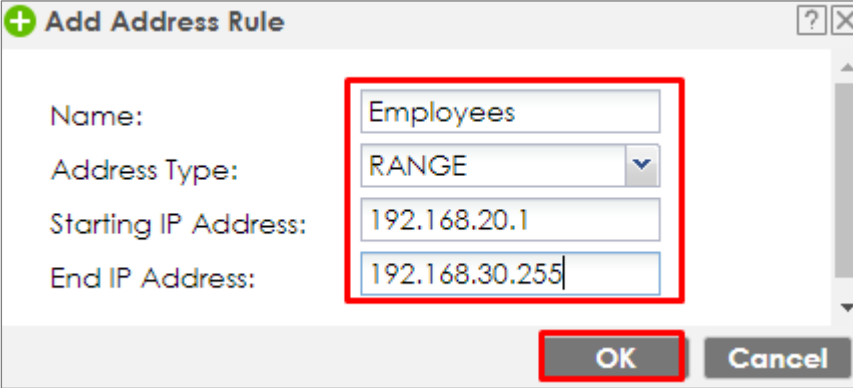

**+ Add Address Rule**

Name: Employees

Address Type: RANGE

Starting IP Address: 192.168.20.1

End IP Address: 192.168.30.255

OK Cancel

Set up **Security Policy** for employees, go to **CONFIGURATION > Security Policy > Policy Control > Add corresponding**, configure a **Name** for you to identify the employees' **Security Policy** profile.

For **From** and **To** policies, select the direction of travel of packets to which the policy applies. Select **Source** to be the **Employees** to apply the policy to all traffic coming from them. In order to view the test result later on, set **Log matched traffic** to be **log**.

Scroll down to **UTM Profile**, select the general policy that allows employees to access the Internet. (Using built-in Office profile in this example blocks the non-productive services, such as Advertisement & Pop-Ups, Gambling and Peer to Peer services...etc.).

**CONFIGURATION > Security Policy > Policy Control > Add corresponding > Employees\_Security**

<input checked="" type="checkbox"/> Enable		
Name:	<input type="text" value="Employees_Security"/>	
Description:	<input type="text"/>	(Optional)
From:	<input type="text" value="LAN"/>	
To:	<input type="text" value="any (Excluding ZyV)"/>	
Source:	<input type="text" value="Employees"/>	
Destination:	<input type="text" value="any"/>	
Service:	<input type="text" value="any"/>	
User:	<input type="text" value="any"/>	
Schedule:	<input type="text" value="none"/>	
Action:	<input type="text" value="allow"/>	
Log matched traffic:	<input type="text" value="log"/>	

<b>UTM Profile</b>				
<input checked="" type="checkbox"/>	Content Filter:	<input type="text" value="Office_profile"/>	Log:	<input type="text" value="by profile"/>
<input type="checkbox"/>	SSL Inspection:	<input type="text" value="none"/>	Log:	<input type="text" value="by profile"/>



## Set Up the Security Policy on the ZyWALL/USG for Executives

In the ZyWALL/USG, go to **CONFIGURATION > Object > User/Group > Add A User** to create **User Name/Password** for each executive.

**CONFIGURATION > Object > User/Group > Add A User**

User Configuration	
User Name :	<input type="text" value="Executive_1"/>
User Type:	<input type="text" value="user"/>
Password:	<input type="password" value="****"/>
Retype:	<input type="password" value="****"/>
Description:	<input type="text" value="Local User"/>

User Configuration	
User Name :	<input type="text" value="Executive_2"/>
User Type:	<input type="text" value="user"/>
Password:	<input type="password" value="****"/>
Retype:	<input type="password" value="****"/>
Description:	<input type="text" value="Local User"/>

User Configuration	
User Name :	<input type="text" value="Executive_3"/>
User Type:	<input type="text" value="user"/>
Password:	<input type="password" value="****"/>
Retype:	<input type="password" value="****"/>
Description:	<input type="text" value="Local User"/>

Then, go to **CONFIGURATION > Object > User/Group > Group > Add Group** to create a **Group Members' Name** and move the just created executives user object to **Member**.

**CONFIGURATION > Object > Address Group > Add Address Group Rule**

**Configuration**

Name:

Description:  (Optional)

**Member List**

Available		Member
=== Object ===		
Executive_1	➔	
Executive_2		
Executive_3		
ad-users	⬅	
ldap-users		
radius-users		

Set up **Security Policy** for executives, go to **CONFIGURATION > Security Policy > Policy Control > Add corresponding**, configure a **Name** for you to identify the executives' **Security Policy** profile.

For **From** and **To** policies, select the direction of travel of packets to which the policy applies. Select **User** to be the **Executives** to apply the policy to all traffic coming from them.

In order to view the test result later on, set **Log matched traffic** to be **log**.

Leave all **UTM Profiles** disabled.

**CONFIGURATION > Security Policy > Policy Control > Add corresponding > Employees\_Security**

<input checked="" type="checkbox"/> Enable	
Name:	Executive_Security
Description:	<input type="text"/> (Optional)
From:	LAN
To:	any (Excluding ZyV
Source:	any
Destination:	any
Service:	any
User:	Executive
Schedule:	none
Action:	allow
Log matched traffic:	log

UTM Profile

## Test the Result

Connect to the Internet from two computers: one from executive\_1 and one from an employee address (192.168.30.9).

Go to the ZyWALL/USG **Monitor > Log**, you will see [notice] log message such as below. In this example result, a connection from executive\_1 has user login message and always with **ACCESS FORWARD** information. A connection from employee address (192.168.30.9) and some of the services are with **ACCESS BLOCK** information

## Monitor > Log

Priority	Category	Message	Source	Destination	Note
notice	Security Policy Control	priority:1, from LAN to ANY, TCP, service others, ACCEPT	192.168.1.33:60045	172.23.5.208:8080	ACCESS FORWARD
notice	Security Policy Control	priority:1, from LAN to ANY, TCP, service others, ACCEPT	192.168.1.33:60044	59.124.183.66:443	ACCESS FORWARD
notice	User	User Executive_1 (MAC=F0:DE:F1:B7:FB:7E) from http/https has logged in Device	192.168.1.33	59.124.183.150	Account: Executive_1

Priority	Category	Message	Source	Destination	Note
notice	Security Policy Control	priority:2, from LAN to ANY, TCP, service others, ACCEPT	192.168.30.9:50928	74.125.23.189:443	ACCESS FORWARD
info	Application Patrol	Rule_id=2 SSI=N App=[Social Network]Google-plus:authority Action=reject SID=402692097	192.168.30.9:50926	74.125.23.113:443	ACCESS BLOCK
info	Application Patrol	Rule_id=2 SSI=N App=[Social Network]Facebook:authority Action=reject SID=402653953	192.168.30.9:51041	66.220.158.19:443	ACCESS BLOCK

## What Could Go Wrong?

If you are not be able to configure any **UTM** policies or it's not working, there are two possible reasons:

- You have not subscribed for the **UTM** service.

- You have subscribed for the **UTM** service but the license is expired.

You can click the link from the **CONFIGURATION > Licensing > Registration** screen of your ZyXEL device's Web Configurator or click the myZyXEL.com 2.0 icon from the portal page (<https://portal.myzyxel.com/>) to register or extend your **UTM** license.

## How To Detect and Prevent TCP Port Scanning with ADP

This is an example of using a ZyWALL/USG ADP (Anomaly Detection and Prevention) Profile to protect against anomalies based on violations of protocol standards (RFCs – Requests for Comments) and abnormal traffic flows such as port scans.

ZyWALL/USG with ADP Profile Setting Example

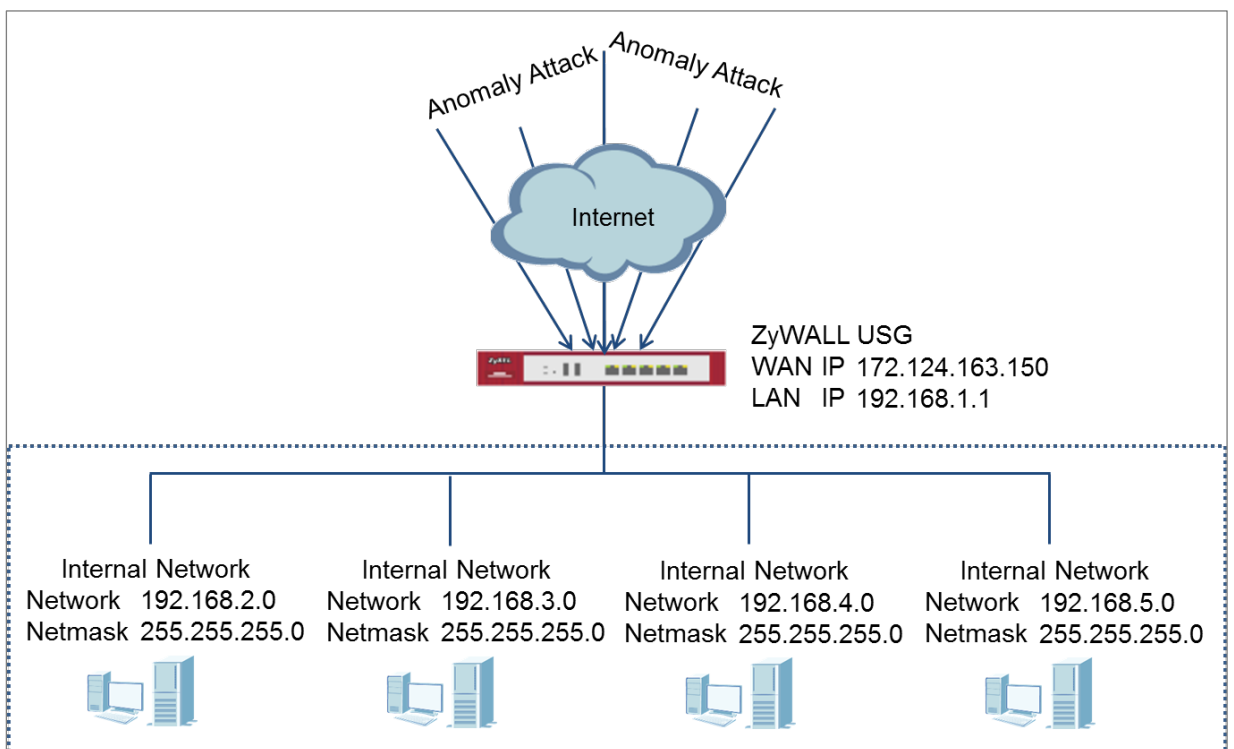

 Note: All network IP addresses and subnet masks are used as examples in this article. Please replace them with your actual network IP addresses and subnet masks. This example was tested using USG310 (Firmware Version: ZLD 4.25).

## Set Up the ADP Profile on the ZyWALL/USG

In the ZyWALL/USG, go to **CONFIGURATION > Security Policy > ADP > Profile**, click the **Add** icon. A pop-up screen will appear allowing you to choose a base profile. Select a base profile to go to the profile details screen.

**CONFIGURATION > Security Policy > ADP > Profile > Base Profile**

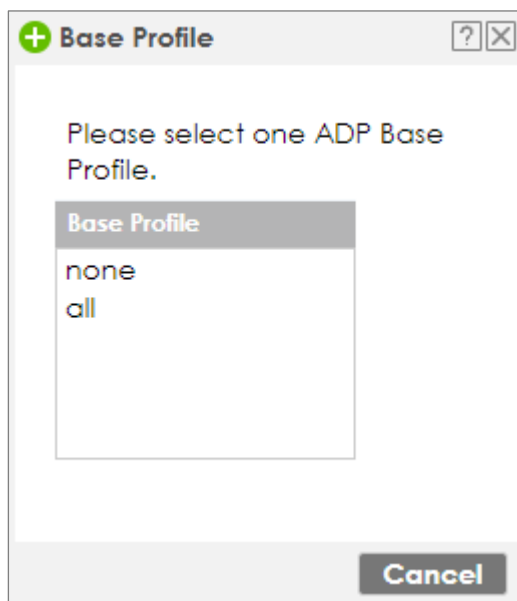

The **Traffic Anomaly** screen will display. A **Name** is automatically generated that you can edit. Enable or disable individual scan or flood types by selecting a row and clicking **Activate** or **Inactivate**.

In the **Scan Detection** section, selecting levels in the **Sensitivity** drop-down menu and set **Block Period** for the duration applies blocking to the source IP address.

In the **Flood Detection** section, set **Block Period** for the duration applies blocking to the destination IP address. Set a **Threshold** number (the number of packets per second that match the flood detection criteria) for your network. Click **OK**.

**CONFIGURATION > Security Policy > ADP > Profile > Base Profile > Traffic Anomaly**

**General**

Name:

Description:

**Scan Detection**

Sensitivity:

Block Period:  (1-3600 seconds)

#	Status	Name ^	Log	Action
1		(portscan) IP Protocol Scan	no	none
2		(portscan) TCP Portscan	no	none
3		(portscan) UDP Portscan	no	none
4		(sweep) ICMP Sweep	no	none
5		(sweep) IP Protocol Sweep	no	none
6		(sweep) TCP Port Sweep	no	none
7		(sweep) UDP Port Sweep	no	none

Page 1 of 1 Show 50 items Displaying 1 - 7 of 7

**Flood Detection**

Block Period:  (1-3600 seconds)

#	Status	Name ^	Log	Action	Threshold(p...
1		(flood) ICMP Flood	no	none	<input type="text" value="1000"/>
2		(flood) IP Flood	no	none	1000
3		(flood) TCP Flood	no	none	1000
4		(flood) UDP Flood	no	none	1000

Page 1 of 1 Show 50 items Displaying 1 - 4 of 4

Click the **Protocol Anomaly** tab. A **Name** is automatically generated that you can edit. Enable or disable individual rules by selecting a row and clicking **Activate** or **Inactivate**. Edit the default log options and actions by selecting a row and making a selection in the **Log** or **Action** drop-down menus. Click **OK**.

**CONFIGURATION > Security Policy > ADP > Profile > Base Profile > Protocol Anomaly**

**General**

Name:

Description:

**TCP Decoder**

Activate  Inactivate

#	Status	Name	Log	Action
1		(tcp_decoder) BAD-LENGTH-OPTI...	no	none
2		(tcp_decoder) EXPERIMENTAL-OP...	no	none
3		(tcp_decoder) OBSOLETE-OPTION...	no	none
4		(tcp_decoder) OVERSIZE-OFFSET A...	no	none
5		(tcp_decoder) TRUNCATED-OPTIO...	no	none
6		(tcp_decoder) TTCP-DETECTED AT...	no	none
7		(tcp_decoder) UNDERSIZE-LEN ATT...	no	none
8		(tcp_decoder) UNDERSIZE-OFFSET ...	no	none
9		(tcp_decoder) tcp-fragment ATTA...	no	none

Page 1 of 1 Show 50 items Displaying 1 - 9 of 9

**UDP Decoder**

Activate  Inactivate

#	Status	Name	Log	Action
1		(udp_decoder) OVERSIZE-LEN ATT...	no	none
2		(udp_decoder) TRUNCATED-HEAD...	no	none
3		(udp_decoder) UNDERSIZE-LEN AT...	no	none

Page 1 of 1 Show 50 items Displaying 1 - 3 of 3

**ICMP Decoder**

Activate  Inactivate

#	Status	Name	Log	Action
1		(icmp_decoder) TRUNCATED-ADD...	no	none
2		(icmp_decoder) TRUNCATED-HEA...	no	none
3		(icmp_decoder) TRUNCATED-TIME...	no	none
4		(icmp_decoder) icmp-fragment ...	no	none

Page 1 of 1 Show 50 items Displaying 1 - 4 of 4

**IP Decoder**

Activate  Inactivate

#	Status	Name	Log	Action
1		(ip_decoder) BAD-LENGTH-OPTIO...	no	none
2		(ip_decoder) IP-land ATTACK	no	none
3		(ip_decoder) TRUNCATED-OPTION...	no	none
4		(ip_decoder) UNDERSIZE-LEN ATTA...	no	none
5		(ip_decoder) ip-spoof ATTACK	no	none
6		(ip_decoder) ip-teardrop ATTACK	no	none

Page 1 of 1 Show 50 items Displaying 1 - 6 of 6

Go to **CONFIGURATION > Security Policy > ADP > General**, select **Enable Anomaly**



**Detection and Prevention.** Then, select the just created **Anomaly Profile** and click **Apply**.

**CONFIGURATION > Security Policy > ADP > General**

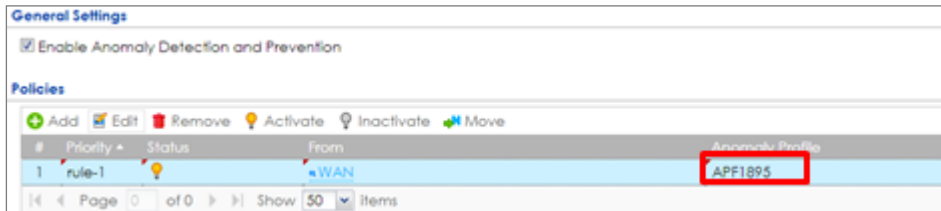

## Test the Result

Download Nmap free security scanner for testing the result:

<https://nmap.org/download.html>

Open the Nmap GUI, set the **Target** to be the WAN IP of ZyWALL/USG (172.124.163.150 in this example) and set **Profile** to be **Intense Scan**. Click **Scan**.

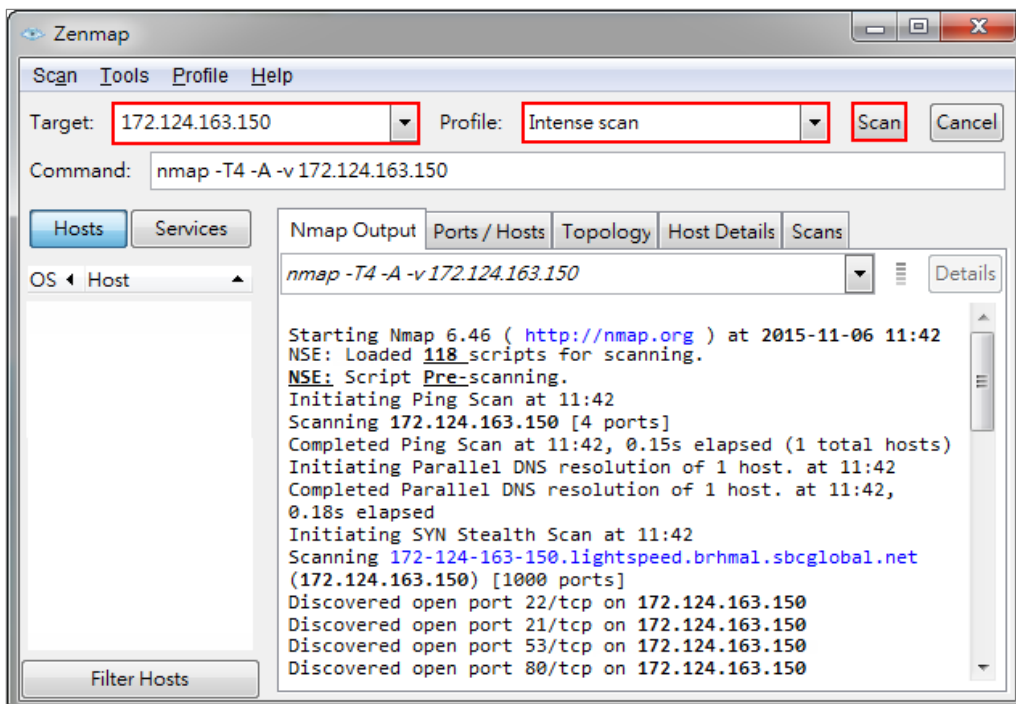

Go to the ZyWALL/USG **Monitor > Log**, you will see [warn] log message such as below.

### Monitor > Log

Priority	Category	Message	Source	Destination	Note
warn	ADP	from Any to ZyWALL, [type=Scan-Detection(8910011)] tcp-portscan-syn tcp-portscan-syn Action: Block Severity: medium	192.168.123.33:40347	172.124.163.150:1271	ACCESS BLOCK
warn	ADP	from Any to ZyWALL, [type=Scan-Detection(8910011)] tcp-portscan-syn tcp-portscan-syn Action: Block Severity: medium	192.168.123.33:40374	172.124.163.150:8888	ACCESS BLOCK
warn	ADP	from Any to ZyWALL, [type=Scan-Detection(8910011)] tcp-portscan-syn tcp-portscan-syn Action: Block Severity: medium	192.168.123.33:40348	172.124.163.150:13	ACCESS BLOCK
warn	ADP	from Any to ZyWALL, [type=Scan-Detection(8910011)] tcp-portscan-syn tcp-portscan-syn Action: Block Severity: medium	192.168.123.33:40347	172.124.163.150:15003	ACCESS BLOCK

## What Could Go Wrong?

You may find that certain rules are triggering too many false positives or false negatives. A false positive is when valid traffic is flagged as an attack. A false negative is when invalid traffic is wrongly allowed to pass through the ZyWALL/USG. As each network is different, false positives and false negatives are common on initial ADP deployment. You could create a new 'monitor profile' that creates logs but all actions are disabled. Observe the logs over time and try to eliminate the causes of the false alarms. When you're satisfied that they have been reduced to an acceptable level, you could then create an 'inline profile' whereby you configure appropriate actions to be taken when a packet matches a detection.

## How To Block Facebook

This is an example of using a ZyWALL/USG UTM Profile in a Security Policy to block access to a specific social network service. You can use Content Filter, SSL Inspection and Policy Control to make sure that a certain web page cannot be accessed through both HTTP and HTTPS protocols.

ZyWALL/USG with Block Facebook Settings Example

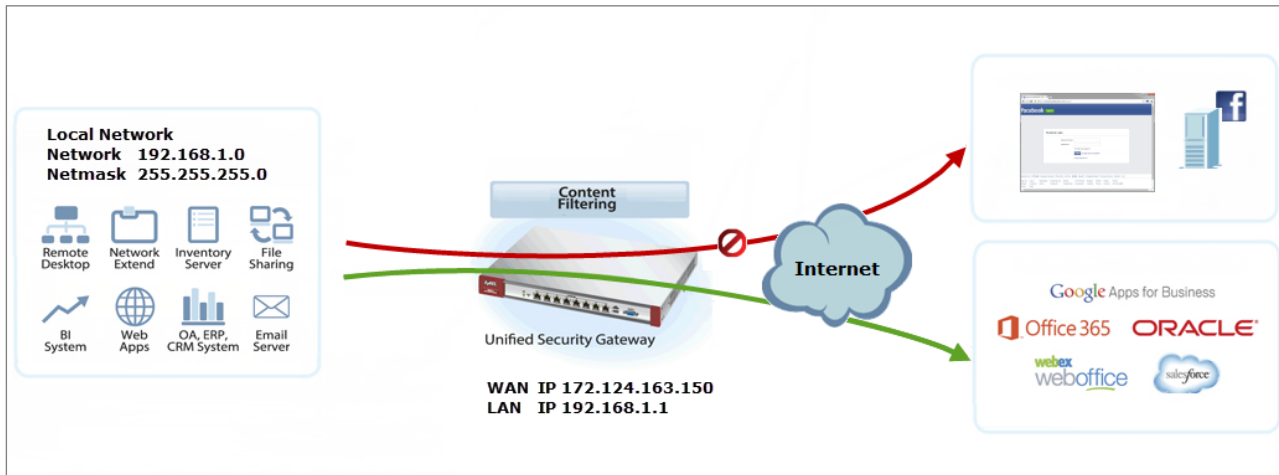

 Note: All network IP addresses and subnet masks are used as examples in this article. Please replace them with your actual network IP addresses and subnet masks. This example was tested using USG310 (Firmware Version: ZLD 4.25).

## Set Up the Content Filter on the ZyWALL/USG

In the ZyWALL/USG, go to **CONFIGURATION > UTM Profile > Content Filter > Profile Management > Add Filter File > Custom Service**. Configure a **Name** for you to identify the **Content Filter Profile** and select **Enable Custom Service**.

**CONFIGURATION > UTM Profile > Content Filter > Profile > Profile Management > Add Filter File > Custom Service > General Settings**

**General Settings**

Name:

Description:  (Optional)

Enable Custom Service

Allow web traffic for trusted web sites only

Check Common Trusted/Forbidden List

Scroll down to the **Blocked URL Keywords** section, click **Add** and use "\*" as a wildcard to match any string in trusted/forbidden web sites and blocked URL keywords (\*.facebook\*.com in this example). Click **OK**.

**CONFIGURATION > UTM Profile > Content Filter > Profile > Profile Management > Add Filter File > Custom Service > Blocked URL Keywords**

**Blocked URL Keywords**

#	Blocked URL Keywords
1	*.facebook*.com

Page 0 of 0 | Show 50 items | No data to display

## Set Up the SSL Inspection on the ZyWALL/USG

In the ZyWALL/USG, go to **CONFIGURATION > UTM Profile > SSL Inspection > Add rule**, configure a **Name** for you to identify the **SSL Inspection** profile.

Then, select the **CA Certificate** to be the certificate used in this profile. Select

**Block** to **Action for Connection with SSL v3** and select **Log** type to be **log alert**.

Leave other actions as default settings.

**CONFIGURATION > UTM Profile > SSL Inspection > Add rule**

General Settings			
Name:	<input type="text" value="Facebook_Block"/>		
Description:	<input type="text"/>		
CA Certificate:	<input type="text" value="default"/>		
SSL/TLS version supported minimum:	<input type="text" value="ssl3"/>	Log:	<input type="text" value="no"/>
Action for connection with unsupported suit:	<input type="text" value="pass"/>	Log:	<input type="text" value="no"/>
Action for connection with untrusted cert chain:	<input type="text" value="pass"/>	Log:	<input type="text" value="log"/>

## Set Up the Security Policy on the ZyWALL/USG

In the ZyWALL/USG, go to **CONFIGURATION > Security Policy > Policy Control**, configure a **Name** for you to identify the **Security Policy** profile. For **From** and **To** policies, select the direction of travel of packets to which the policy applies. Select the **Schedule** that defines when the policy applies (Facebook\_Block in this example).

Scroll down to **UTM Profile**, select **Content Filter** and select a profile from the list box (Facebook\_Block in this example). Then, select **SSL Inspection** and select a profile from the list box (Facebook\_Block in this example).

### CONFIGURATION > Security Policy > Policy Control

<input checked="" type="checkbox"/> Enable	
Name:	Facebook_Block
Description:	(Optional)
From:	LAN
To:	any (Excluding ZyV)
Source:	any
Destination:	any
Service:	any
User:	any
Schedule:	none
Action:	allow
Log matched traffic:	no

<b>UTM Profile</b>	
<input checked="" type="checkbox"/> Content Filter:	Facebook_Block Log: by profile
<input checked="" type="checkbox"/> SSL Inspection:	Facebook_Block Log: by profile

## Export Certificate from ZyWALL/USG and Import it to Windows 7 Operation System

When SSL inspection is enabled and an access website does not trust the ZyWALL/USG certificate, the browser will display a warning page of security certificate problems.

Go to ZyWALL/USG **CONFIGURATION > Object > Certificate > default > Edit** to export default certificate from ZyWALL/USG with Private Key (zyx123 in this example).

### CONFIGURATION > Object > Certificate > default

#	Name	Type	Subject	Issuer	Valid From	Valid To
1	default	SELF	CN=vpn300_B8ECA3A9C...	CN=vpn300_B8ECA3A9C...	2017-04-25 12:41:25 GMT	2027-04-23 12:41:25 GMT

### CONFIGURATION > Object > Certificate > default > Edit > Export Certificate with Private Key

Issuer: CN=vpn300\_B8ECA3A9C003  
 Signature Algorithm: rsa-pkcs1-sha256  
 Valid From: 2017-04-25 12:41:25 GMT  
 Valid To: 2027-04-23 12:41:25 GMT  
 Key Algorithm: rsaEncryption (2048 bits)  
 Subject Alternative Name: vpn300\_B8ECA3A9C003  
 Key Usage: DigitalSignature, KeyEncipherment, DataEncipherment, KeyCertSi  
 Extended Key Usage:  
 Basic Constraint: Subject Type=CA, Path Length Constraint=1  
 MD5 Fingerprint: 1b:a9:ff:f3:e6:42:44:9c:90:8d:bc:3e:f9:07:af:26  
 SHA1 Fingerprint: 1b:dd:6e:b2:c7:89:2e:ea:43:a0:ee:d2:55:3a:ff:15:89:bc:64:70

**Certificate in PEM (Base-64) Encoded Format**  
 -----BEGIN X509 CERTIFICATE-----  
 MIIDSzCCAjOgAwIBAgIJAP0XXinyW6C/MA0GC5qGSIlb3DQEBcwUAMB4xHDAaBgNV  
 BAMME3ZwbjMwMF9COEVDQTNBOUMwMDMwHhcNMtcwNDI1MTI0MTI1WhcNMjcw  
 NDlz

Password:

Save default certificate as \*.p12 file to Windows 7 Operation System.



default.p12

In Windows 7 Operating System **Start Menu > Search Box**, type **mmc** and press **Enter**.

**Start Menu > Search Box > mmc**

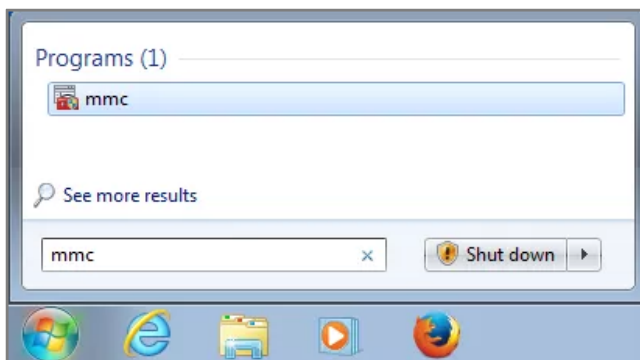



In the mmc console window, click **File > Add/Remove Snap-in...**

### File > Add/Remove Snap-in...

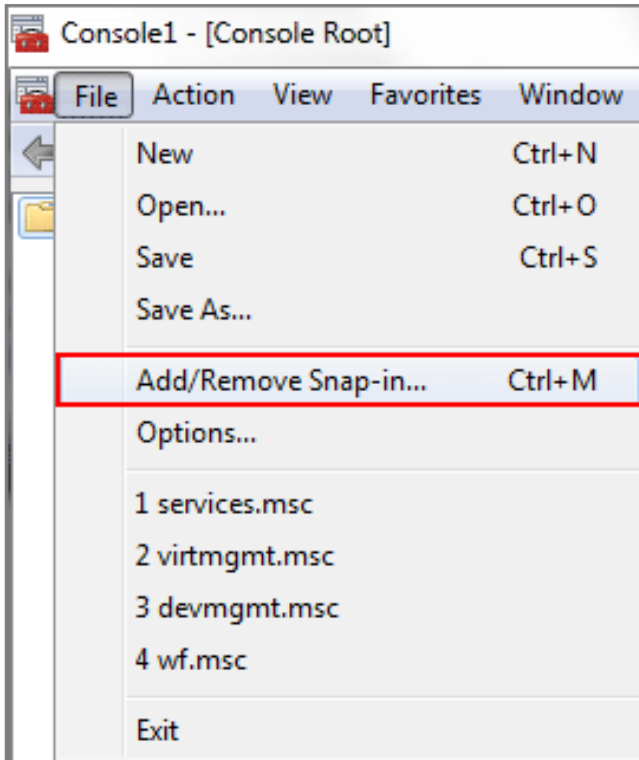

In the **Available snap-ins**, select the **Certificates** and click **Add** button. Select **Computer account > Local Computer**. Then, click **Finished** and **OK** to close the **Snap-ins** window.

### Available snap-ins > Certificates > Add

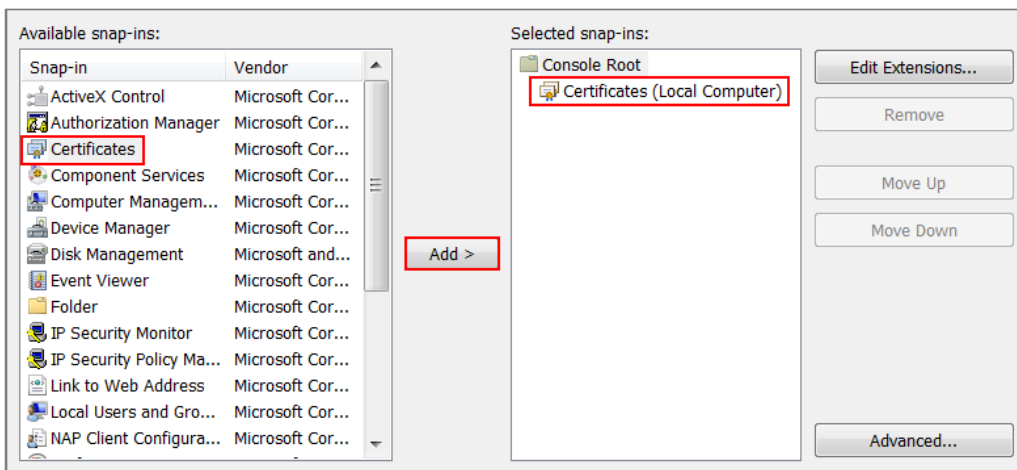

In the mmc console window, open the **Certificates (Local Computer) > Trusted Root Certification Authorities**, right click **Certificate > All Tasks > Import...**

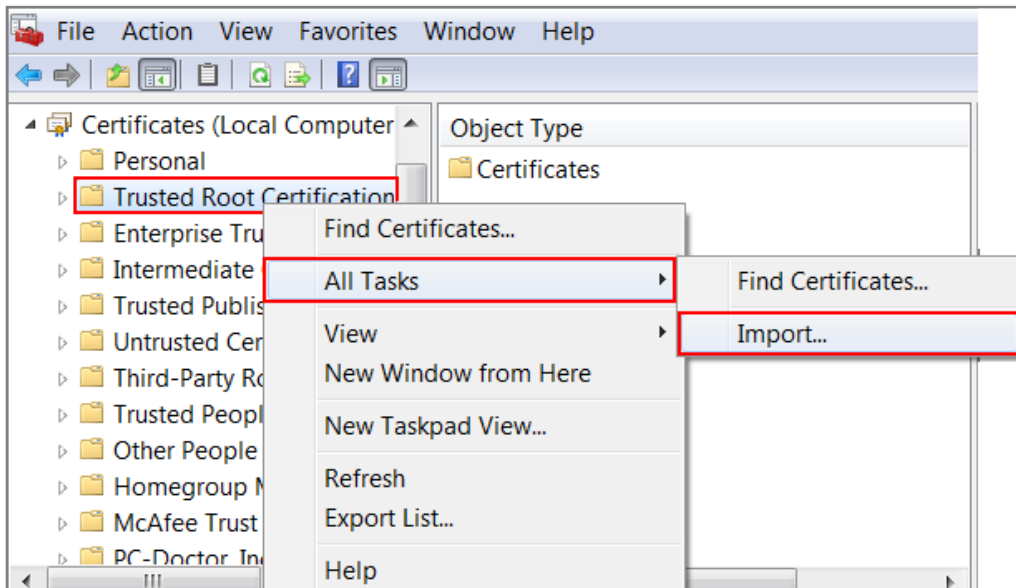

Click **Next**. Then, **Browse...**, and locate the .p12 file you downloaded earlier. Then, click **Next**.

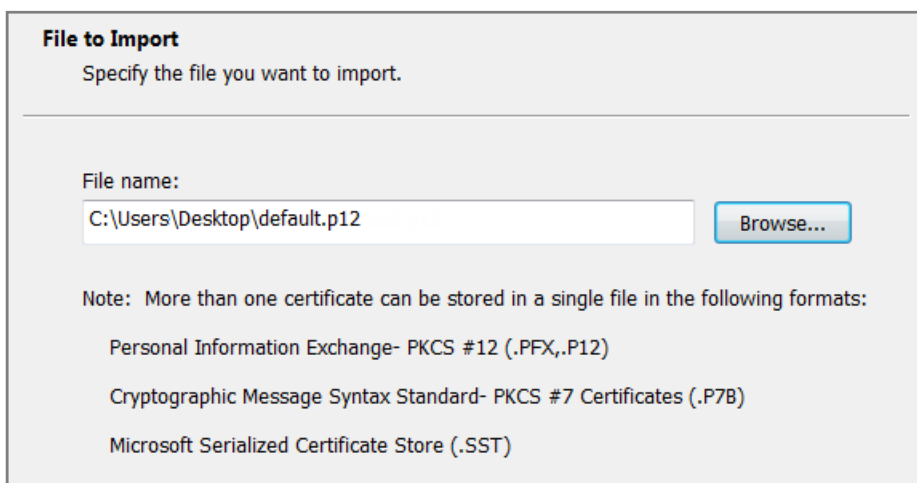

Click **Next**, type **zyx123** in the **Password** field and click **Next** again

**Password**

To maintain security, the private key was protected with a password.

---

Type the password for the private key.

Password:

•••••

Enable strong private key protection. You will be prompted every time the private key is used by an application if you enable this option.

Mark this key as exportable. This will allow you to back up or transport your keys at a later time.

Include all extended properties.

Select **Place all certificates in the following store** and then click **Browse** and find **Trusted Root Certification Authorities**. Click **Next**, then click **Finish**.

**Certificate Store**

Certificate stores are system areas where certificates are kept.

---

Windows can automatically select a certificate store, or you can specify a location for the certificate.

Automatically select the certificate store based on the type of certificate

Place all certificates in the following store

Certificate store:

Trusted Root Certification Authorities

Browse...

 **Note:** Each ZyWALL/USG device has its own self-signed certificate by factory default. When you reset to default configuration file, the original self-signed certificate is erased, and a new self-signed certificate will be created when the ZyWALL/USG boots the next time.

## Test the Result

Type <http://www.facebook.com/> or <https://www.facebook.com/> into the browser, the error message occurs.

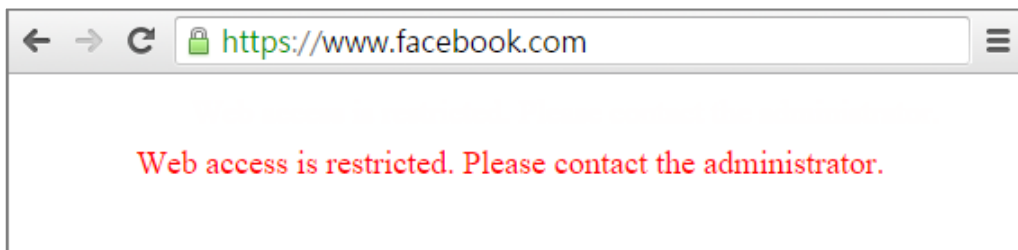

Go to the ZyWALL/USG **Monitor > Log**, you will see [alert] log message such as below.

### Monitor > Log

Priority	Category	Message	Note
alert	Blocked web sites	d2ebu295n9axq5.webhst.com: Keyword blocking, Rule_id=1, SSI=N	WEB BLOCK
alert	Blocked web sites	d2ebu295n9axq5.webhst.com: Keyword blocking, Rule_id=1, SSI=N	WEB BLOCK

## What Could Go Wrong?

If you are not be able to configure any **Content Filter** policies or it's not working, there are two possible reasons:

You have not subscribed for the **Content Filter** service.

You have subscribed for the **Content Filter** service but the license is expired.

You can click the link from the **CONFIGURATION > Licensing > Registration** screen of your ZyXEL device's Web Configurator or click the myZyXEL.com 2.0 icon from the portal page (<https://portal.myzyxel.com/>) to register or extend your **Content Filter** license.

## How To Exempt Specific Users From a Blocked Website

This is an example of using a ZyWALL/USG Security Policy to exempt three corporate executives from a blocked Website, while controlling Internet access for other employees' accounts.

With executives connect to a blocked Website using PCs with static IP addresses, you could set up address group to allow their traffic.

ZyWALL/USG with Exempt Specific Users From a Blocked Website Example

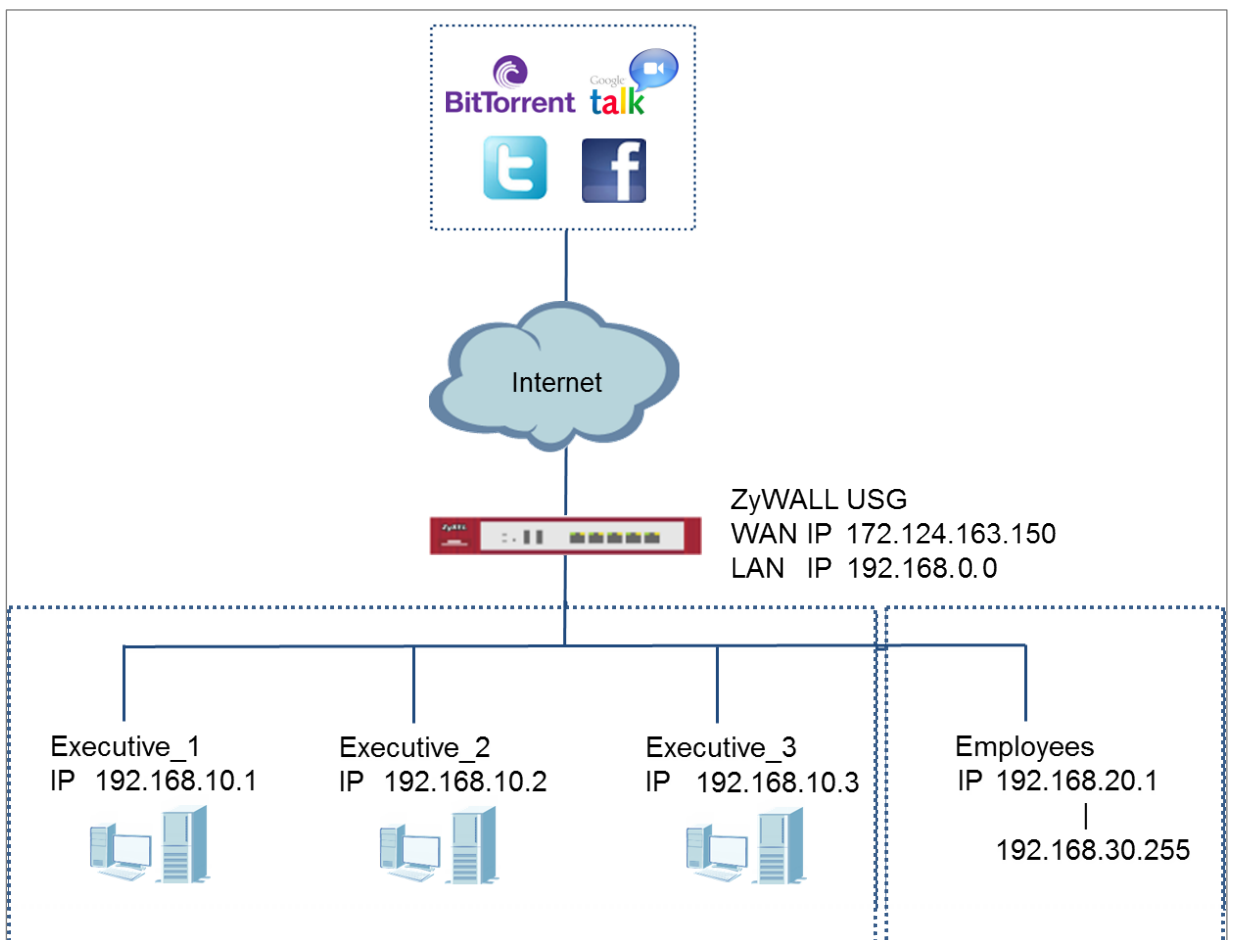

 Note: All network IP addresses and subnet masks are used as examples in this article. Please replace them with your actual network IP addresses and subnet masks. This example was tested using USG310 (Firmware Version: ZLD 4.25).

## Set Up the Security Policy on the ZyWALL/USG for Employees

In the ZyWALL/USG, go to **CONFIGURATION > Object > Address > Add Address Rule** to create address range for employees.

**CONFIGURATION > Object > Address > Add Address Rule**



**Edit Address Rule Employees**

Name: Employees

Address Type: RANGE

Starting IP Address: 192.168.20.1

End IP Address: 192.168.30.255

OK Cancel

Set up **Security Policy** for employees, go to **CONFIGURATION > Security Policy > Policy Control > Add corresponding**, configure a **Name** for you to identify the employees' **Security Policy** profile.

For **From** and **To** policies, select the direction of travel of packets to which the policy applies. Select **Source** to be the **Employees** to apply the policy to all traffic coming from them.

Scroll down to **UTM Profile**, select the general policy that allows employees to access the Internet. (Using built-in Office profile in this example blocks the non-productive services, such as Advertisement & Pop-Ups, Gambling and Peer to Peer services...etc.).

**CONFIGURATION > Security Policy > Policy Control > Add corresponding > Employees\_Security**

<input checked="" type="checkbox"/> Enable		
Name:	Employees Security	
Description:		(Optional)
From:	LAN	
To:	any (Excluding ZyV	
Source:	Employees	
Destination:	any	
Service:	any	
User:	any	
Schedule:	none	
Action:	allow	
Log matched traffic:	log	

<b>UTM Profile</b>				
<input checked="" type="checkbox"/>	Content Filter:	Office profile	Log:	by profile
<input type="checkbox"/>	SSL Inspection:	none	Log:	by profile



## Set Up the Security Policy on the ZyWALL/USG for Executives

In the ZyWALL/USG, go to **CONFIGURATION > Object > Address > Add Address Rule** to create address for each executives.

**CONFIGURATION > Object > Address > Add Address Rule**

The screenshot shows a dialog box titled "Add Address Rule" with a green plus icon and a close button. It contains three input fields: "Name" with the value "Executive\_1", "Address Type" with a dropdown menu set to "HOST", and "IP Address" with the value "192.168.10.1". At the bottom right, there are "OK" and "Cancel" buttons.

The screenshot shows a dialog box titled "Add Address Rule" with a green plus icon and a close button. It contains three input fields: "Name" with the value "Executive\_2", "Address Type" with a dropdown menu set to "HOST", and "IP Address" with the value "192.168.10.2". At the bottom right, there are "OK" and "Cancel" buttons.

The screenshot shows a dialog box titled "Add Address Rule" with a green plus icon and a close button. It contains three input fields: "Name" with the value "Executive\_3", "Address Type" with a dropdown menu set to "HOST", and "IP Address" with the value "192.168.10.3". At the bottom right, there are "OK" and "Cancel" buttons.

Then, go to **CONFIGURATION > Object > Address Group > Add Address Group Rule** to create a **Group Members' Name** and move the just created executives

address object to **Member**.

**CONFIGURATION > Object > Address Group > Add Address Group Rule**

**Configuration**

Name:  (Optional)

Description:  (Optional)

**Member List**

Available	Member
=== Object ===	
ad-users	
ldap-users	
radius-users	
<b>Executive_1</b>	
Executive_2	
Executive_3	

Set up **Security Policy** for executives, go to **CONFIGURATION > Security Policy > Policy Control > Add corresponding**, configure a **Name** for you to identify the executives' **Security Policy** profile.

For **From** and **To** policies, select the direction of travel of packets to which the policy applies. Select **Source** to be the **Executives** to apply the policy to all traffic coming from them. In order to view the results later, to have the ZyWALL/USG generate **Log matched traffic (log)**.

Leave all UTM Profiles disabled.

**CONFIGURATION > Security Policy > Policy Control > Add corresponding > Executives\_Security**

<input checked="" type="checkbox"/> Enable	
Name:	<input type="text" value="Executive_Security"/>
Description:	<input type="text"/> (Optional)
From:	<input type="text" value="LAN"/>
To:	<input type="text" value="any (Excluding ZyV"/>
Source:	<input type="text" value="any"/>
Destination:	<input type="text" value="any"/>
Service:	<input type="text" value="any"/>
User:	<input type="text" value="Executive"/>
Schedule:	<input type="text" value="none"/>
Action:	<input type="text" value="allow"/>
Log matched traffic:	<input type="text" value="log"/>

## Test the Result

Connect to the Internet from two computers: one from executive\_2 address (192.168.10.2) and one from an employee address (192.168.20.1) and both access to <https://hangouts.google.com/>.

Go to the ZyWALL/USG **Monitor > Log**, you will see [notice] and [info] log message such as below. In this example result, connections from executive\_2 address (192.168.10.2) use **Security Policy** priority: 1. Connections from employee address (192.168.20.1) use **Security Policy** priority: 2 and **UTM Profile** Rule\_id=2.

Priority	Category	Message	Source	Destination	Note
notice	Security Policy Control	priority:1, from LAN to ANY, TCP, service others, ACCEPT	192.168.10.2:52549	172.23.6.115:5088	ACCESS FORWARD
notice	Security Policy Control	priority:1, from LAN to ANY, TCP, service others, ACCEPT	192.168.10.2:54956	64.233.189.125:5222	ACCESS FORWARD

Priority	Category	Message	Source	Destination	Note
info	Application Patrol	Rule_id=2 SSI=N App=[Instant messaging]Google Talk:authority Action=reject SID=2305	192.168.20.1:53690	64.233.189.125:5222	ACCESS BLOCK
notice	Security Policy Control	priority:2, from LAN to ANY, TCP, service others, ACCEPT	192.168.20.1:53690	64.233.189.125:5222	ACCESS FORWARD
info	Application Patrol	Rule_id=2 SSI=N App=[Social Network]Google-plus:authority Action=reject SID=402692097	192.168.20.1:53688	74.125.203.102:443	ACCESS BLOCK

## What Could Go Wrong?

If you are not be able to configure any **UTM** policies or it's not working, there are two possible reasons:

You have not subscribed for the **UTM** service.

You have subscribed for the **UTM** service but the license is expired.

You can click the link from the **CONFIGURATION > Licensing > Registration** screen of your ZyXEL device's Web Configurator or click the myZyXEL.com 2.0 icon from the portal page (<https://portal.myzyxel.com/>) to register or extend your **UTM** license.

## How To Control Access To Google Drive

This is an example of using a ZyWALL/USG UTM Profile in a Security Policy to block access to a specific file transfer service. You can use Application Patrol and Policy Control to make sure that a certain file transfer service cannot be accessed through both HTTP and HTTPS protocols.

### ZyWALL/USG with Control Access To Google Drive Settings Example

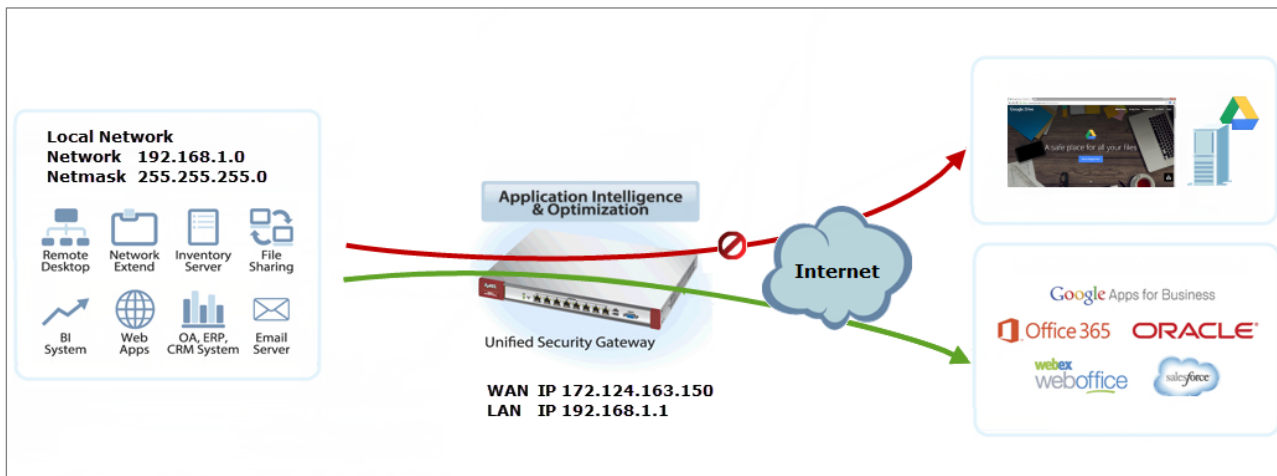

 Note: All network IP addresses and subnet masks are used as examples in this article. Please replace them with your actual network IP addresses and subnet masks. This example was tested using USG310 (Firmware Version: ZLD 4.25).

## Set Up the SSL Inspection on the ZyWALL/USG

In the ZyWALL/USG, go to **CONFIGURATION > UTM Profile > SSL Inspection > Add rule**, configure a **Name** for you to identify the **SSL Inspection** profile.

Then, select the **CA Certificate** to be the certificate used in this profile. Select **Block** to **Action for Connection with SSL v3** and select **Log** type to be **log alert**. Leave other actions as default settings.

**CONFIGURATION > UTM Profile > SSL Inspection > Add rule**

General Settings			
Name:	<input type="text" value="Google Drive Contr."/>		
Description:	<input type="text"/>		
CA Certificate:	<input type="text" value="default"/>		
SSL/TLS version supported minimum:	<input type="text" value="ssl3"/>	Log:	<input type="text" value="log alert"/>
Action for connection with unsupported suit:	<input type="text" value="pass"/>	Log:	<input type="text" value="no"/>
Action for connection with untrusted cert chain:	<input type="text" value="pass"/>	Log:	<input type="text" value="log"/>

## Set Up the Security Policy on the ZyWALL/USG

In the ZyWALL/USG, go to **CONFIGURATION > Security Policy > Policy Control**, configure a **Name** for you to identify the **Security Policy** profile. For **From** and **To** policies, select the direction of travel of packets to which the policy applies.

Scroll down to **UTM Profile**, select **Content Filter** and select a profile from the list box (Facebook\_Block in this example). Then, select **SSL Inspection** and select a profile from the list box (Facebook\_Block in this example).

### CONFIGURATION > Security Policy > Policy Control

<input checked="" type="checkbox"/> Enable	
Name:	Google_Drive_Contr
Description:	(Optional)
From:	LAN
To:	any (Excluding ZyV
Source:	any
Destination:	any
Service:	any
User:	any
Schedule:	none
Action:	allow
Log matched traffic:	no

<b>UTM Profile</b>		
<input type="checkbox"/> Content Filter:	none	Log: by profile
<input checked="" type="checkbox"/> SSL Inspection:	Google_Drive_Cor	Log: by profile

## Export Certificate from ZyWALL/USG and Import it to Windows 7



## Operation System

When SSL inspection is enabled and an access website does not trust the ZyWALL/USG certificate, the browser will display a warning page of security certificate problems.

Go to ZyWALL/USG **CONFIGURATION > Object > Certificate > default > Edit** to export default certificate from ZyWALL/USG with Private Key (zyx123 in this example).

### CONFIGURATION > Object > Certificate > default

#	Name	Type	Subject	Issuer	Valid From	Valid To
1	default	SELF	CN=vpn300_B8ECA3A9C...	CN=vpn300_B8ECA3A9C...	2017-04-25 12:41:25 GMT	2027-04-23 12:41:25 GMT

Page 1 of 1 | Show 50 Items | Displaying 1 - 1 of 1

### CONFIGURATION > Object > Certificate > default > Edit > Export Certificate with Private Key

**Edit My Certificates**

Issuer: CN=vpn300\_B8ECA3A9C003  
 Signature Algorithm: rsa-pkcs1-sha256  
 Valid From: 2017-04-25 12:41:25 GMT  
 Valid To: 2027-04-23 12:41:25 GMT  
 Key Algorithm: rsaEncryption (2048 bits)  
 Subject Alternative Name: vpn300\_B8ECA3A9C003  
 Key Usage: DigitalSignature, KeyEncipherment, DataEncipherment, KeyCertSi  
 Extended Key Usage:  
 Basic Constraint: Subject Type=CA, Path Length Constraint=1  
 MD5 Fingerprint: 1b:a9:ff:f3:e6:42:44:9c:90:8d:bc:3e:f9:07:af:26  
 SHA1 Fingerprint: 1b:dd:6e:b2:c7:89:2e:ea:43:a0:ee:d2:55:3a:ff:15:89:bc:64:70

**Certificate in PEM (Base-64) Encoded Format**

```
-----BEGIN X509 CERTIFICATE-----
MIIDSzCCAJOgAwIBAgIJAP0XXinyW6C/MA0GCSqGSIb3DQEBCwUAMB4xHDAaBgNV
BAMME3ZwbjMwMF9COEVDQTNBOUMwMDMwHhcNMTCwNDI1MTI0MTI1WhcNMjcw
NDIz
```

Password: [.....]

Save default certificate as \*.p12 file to Windows 7 Operation System.



default.p12

In Windows 7 Operating System **Start Menu > Search Box**, type **mmc** and press **Enter**.

**Start Menu > Search Box > mmc**

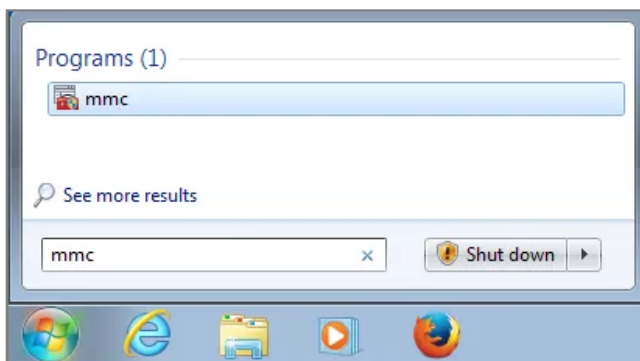

In the mmc console window, click **File > Add/Remove Snap-in...**

**File > Add/Remove Snap-in...**

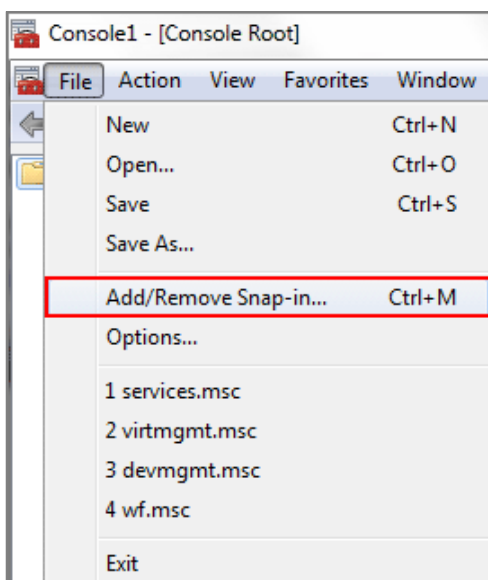

In the **Available snap-ins**, select the **Certificates** and click **Add** button. Select **Computer account > Local Computer**. Then, click **Finished** and **OK** to close the **Snap-ins** window.

### Available snap-ins > Certificates > Add

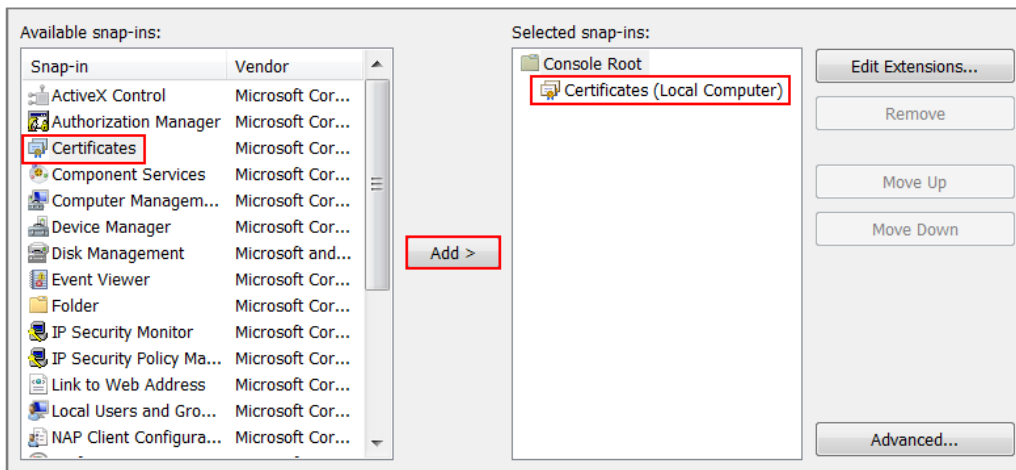

In the mmc console window, open the **Certificates (Local Computer) > Trusted Root Certification Authorities**, right click **Certificate > All Tasks > Import...**

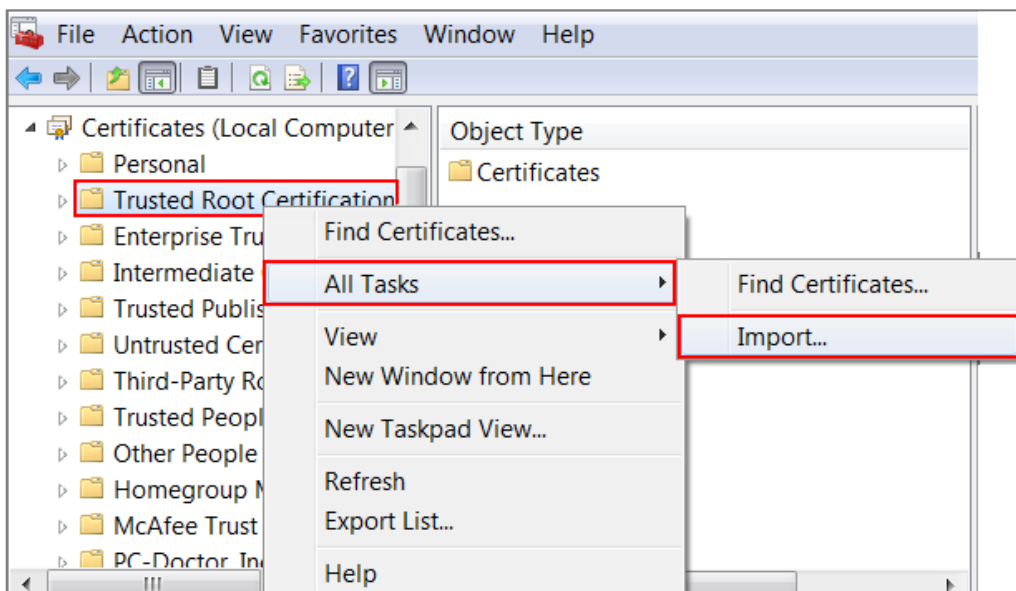

Click **Next**. Then, **Browse...**, and locate the .p12 file you downloaded earlier. Then, click **Next**.

**File to Import**  
Specify the file you want to import.

---

File name:  
C:\Users\Desktop\default.p12

Note: More than one certificate can be stored in a single file in the following formats:

- Personal Information Exchange- PKCS #12 (.PFX,.P12)
- Cryptographic Message Syntax Standard- PKCS #7 Certificates (.P7B)
- Microsoft Serialized Certificate Store (.SST)

Click **Next**, type **zyx123** in the **Password** field and click **Next** again

**Password**  
To maintain security, the private key was protected with a password.

---

Type the password for the private key.

Password:

Enable strong private key protection. You will be prompted every time the private key is used by an application if you enable this option.

Mark this key as exportable. This will allow you to back up or transport your keys at a later time.

Include all extended properties.

Select **Place all certificates in the following store** and then click **Browse** and find **Trusted Root Certification Authorities**. Click **Next**, then click **Finish**.

**Certificate Store**

Certificate stores are system areas where certificates are kept.

---

Windows can automatically select a certificate store, or you can specify a location for the certificate.

Automatically select the certificate store based on the type of certificate

Place all certificates in the following store

Certificate store:

 Note: Each ZyWALL/USG device has its own self-signed certificate by factory default. When you reset to default configuration file, the original self-signed certificate is erased, and a new self-signed certificate will be created when the ZyWALL/USG boots the next time.

## Test the Result

Type <http://drive.google.com/> or <https://drive.google.com/> into the browser, the error message occurs.

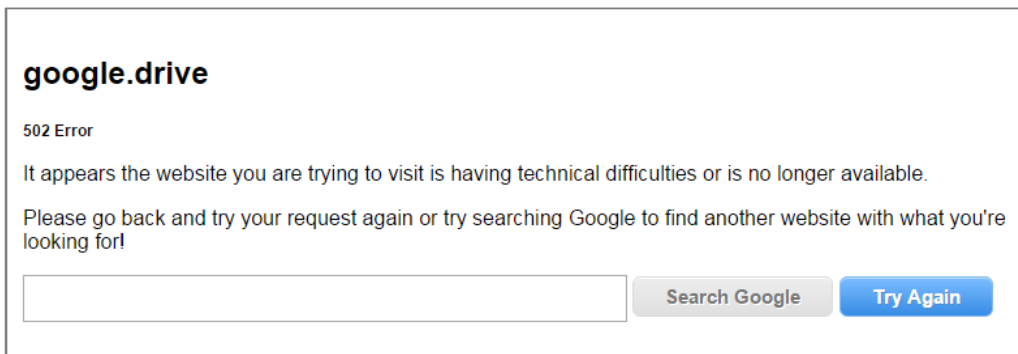

Go to the ZyWALL/USG **Monitor > Log**, you will see [alert] log message such as below.

### Monitor > Log

Priority	Category	Message	Note
alert	Application Patrol	Rule_id=1 SSI=Y App=[File Transfer]Google-drive:access Action=reject SID=50335494	ACCESS BLOCK
alert	Application Patrol	Rule_id=1 SSI=Y App=[File Transfer]Google-drive:access Action=reject SID=50335494	ACCESS BLOCK

## What Could Go Wrong?

If you are not be able to configure any **Application Patrol** policies or it's not working, there are two possible reasons:

You have not subscribed for the **Application Patrol** service.

You have subscribed for the **Application Patrol** service but the license is expired.

You can click the link from the **CONFIGURATION > Licensing > Registration** screen of your ZyXEL device's Web Configurator or click the myZyXEL.com 2.0 icon from the portal page (<https://portal.myzyxel.com/>) to register or extend your **Application Patrol** license.

## How To Block HTTPS Websites Using Content Filtering and SSL Inspection

This is an example of using a ZyWALL/USG Content Filtering, SSL Inspection and Security Policy to block access to malicious or not business-related websites.

ZyWALL/USG with Block HTTPS Websites Using Content Filtering and SSL Inspection Settings Example

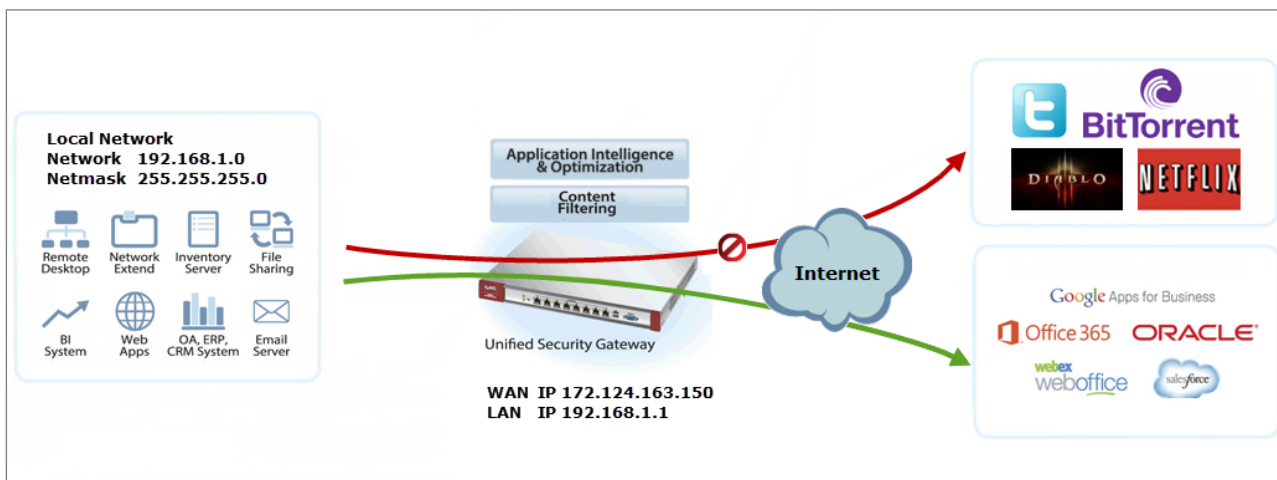

 **Note:** All network IP addresses and subnet masks are used as examples in this article. Please replace them with your actual network IP addresses and subnet masks. This example was tested using USG310 (Firmware Version: ZLD 4.25).



## Set Up the Content Filter on the ZyWALL/USG

In the ZyWALL/USG, go to **CONFIGURATION > UTM Profile > Content Filter > Profile Management > Add Filter File > Category Service**. Configure a **Name** for you to identify the **Content Filter Profile** and select **Enable Custom Service**.

**CONFIGURATION > UTM Profile > Content Filter > Profile > Profile Management > Add > Category Service > General Settings**

**General Settings**

License Status: Licensed  
 License Type: Standard  
 Name: Office\_Profile  
 Description: [ ] (Optional)

Enable SafeSearch  
 Enable Content Filter Category Service  
 Log all web pages

Action for Unsafe Web Pages: Block [ ] Log  
 Action for Managed Web Pages: Block [ ] Log  
 Action for Unrated Web Pages: Warn [ ] Log  
 Action When Category Server Is Unavailable: Warn [ ] Log

Scroll down to the **Security Threat (unsafe)** section and select all categories of web pages that are known to pose a threat to your computers.

**CONFIGURATION > UTM Profile > Content Filter > Profile > Profile Management > Add Filter File > Category Service > Security Threat (unsafe)**

**Security Threat (unsafe)**

Anonymizers  
 Botnets  
 Compromised  
 Malware  
 Network Errors  
 Parked Domains  
 Phishing & Fraud  
 Spam Sites

Scroll down to the **Managed Categories** section and select the categories that are not business-related. Click **OK**.

**CONFIGURATION > UTM Profile> Content Filter > Profile > Profile Management > Add Filter File > Category Service > Managed Categories**

Managed Categories		
<input checked="" type="checkbox"/> Advertisements & Pop-Ups	<input checked="" type="checkbox"/> Alcohol/Tobacco	<input type="checkbox"/> Arts
<input type="checkbox"/> Business	<input type="checkbox"/> Transportation	<input type="checkbox"/> Chat
<input type="checkbox"/> Forums & Newsgroups	<input type="checkbox"/> Computers & Technology	<input checked="" type="checkbox"/> Criminal Activity
<input checked="" type="checkbox"/> Dating & Personals	<input type="checkbox"/> Download Sites	<input type="checkbox"/> Education
<input type="checkbox"/> Entertainment	<input type="checkbox"/> Finance	<input checked="" type="checkbox"/> Gambling
<input checked="" type="checkbox"/> Games	<input type="checkbox"/> Government	<input checked="" type="checkbox"/> Hate & Intolerance
<input type="checkbox"/> Health & Medicine	<input checked="" type="checkbox"/> Illegal Drugs	<input type="checkbox"/> Job Search
<input checked="" type="checkbox"/> Streaming Media & Downloads	<input type="checkbox"/> News	<input type="checkbox"/> Non-profits & NGOs
<input checked="" type="checkbox"/> Nudity	<input type="checkbox"/> Personal Sites	<input type="checkbox"/> Politics
<input checked="" type="checkbox"/> Pornography/Sexually Explicit	<input type="checkbox"/> Real Estate	<input type="checkbox"/> Religion
<input type="checkbox"/> Restaurants & Dining	<input type="checkbox"/> Search Engines/Portals	<input type="checkbox"/> Shopping
<input checked="" type="checkbox"/> Social Networking	<input type="checkbox"/> Sports	<input type="checkbox"/> Translators
<input type="checkbox"/> Travel	<input checked="" type="checkbox"/> Violence	<input checked="" type="checkbox"/> Weapons
<input type="checkbox"/> Web-based Email	<input type="checkbox"/> General	<input type="checkbox"/> Leisure & Recreation
<input checked="" type="checkbox"/> Cults	<input type="checkbox"/> Fashion & Beauty	<input type="checkbox"/> Greeting Cards
<input checked="" type="checkbox"/> Hacking	<input checked="" type="checkbox"/> Illegal Software	<input type="checkbox"/> Image Sharing
<input type="checkbox"/> Information Security	<input type="checkbox"/> Instant Messaging	<input checked="" type="checkbox"/> Peer to Peer
<input type="checkbox"/> Private IP Addresses	<input checked="" type="checkbox"/> School Cheating	<input checked="" type="checkbox"/> Sex Education
<input checked="" type="checkbox"/> Tasteless	<input checked="" type="checkbox"/> Child Abuse Images	

If you are not sure which category a web page belongs to, you can enter a web site URL in the text box of **Test Web Site Category**.

**CONFIGURATION > UTM Profile> Content Filter > Profile > Profile Management > Add Filter File > Category Service > Test Web Site Category**

Test Web Site Category	
URL to test:	<input type="text" value="https://www.youtube.com"/>
<input type="button" value="Test Against Content Filter Category Server"/>	

## Set Up SSL Inspection on the ZyWALL/USG

In the ZyWALL/USG, go to **CONFIGURATION > UTM Profile > SSL Inspection > Add rule**, and configure a **Name** for you to identify the **SSL Inspection** profile.

Then, select the **CA Certificate** to be the certificate used in this profile. Select to **pass** or **block** SSLv2/unsupported suit/untrusted cert chain traffic that matches

traffic bound to this policy here.

Select desired **Log** type whether to have the ZyWALL/USG generate a log (log), log and alert (log alert) or neither (no) by default when traffic matches this policy.

**CONFIGURATION > UTM Profile > SSL Inspection > Add rule**

General Settings			
Name:	<input type="text" value="Office_Control"/>		
Description:	<input type="text"/>		
CA Certificate:	<input type="text" value="default"/>		
SSL/TLS version supported minimum:	<input type="text" value="ssl3"/>	Log:	<input type="text" value="no"/>
Action for connection with unsupported suit:	<input type="text" value="pass"/>	Log:	<input type="text" value="no"/>
Action for connection with untrusted cert chain:	<input type="text" value="pass"/>	Log:	<input type="text" value="log"/>

## Set Up the Security Policy on the ZyWALL/USG

In the ZyWALL/USG, go to **CONFIGURATION > Security Policy > Policy Control**, configure a **Name** for you to identify the **Security Policy** profile. For **From** and **To** policies, select the direction of travel of packets to which the policy applies.

Scroll down to **UTM Profile**, select **Content Filter** and select a profile from the list box (Office\_profile in this example). Then, select **SSL Inspection** and select a profile from the list box (Office\_Control in this example).

### CONFIGURATION > Security Policy > Policy Control

<input checked="" type="checkbox"/> Enable		
Name:	Office_Control	
Description:		(Optional)
From:	LAN	
To:	any (Excluding ZyV	
Source:	any	
Destination:	any	
Service:	any	
User:	any	
Schedule:	none	
Action:	allow	
Log matched traffic:	no	

<b>UTM Profile</b>				
<input checked="" type="checkbox"/>	Content Filter:	Office_profile	Log:	by profile
<input checked="" type="checkbox"/>	SSL Inspection:	Office_Control	Log:	by profile

## Export Certificate from ZyWALL/USG and Import it to Windows 7 Operation System

When SSL inspection is enabled and an access website does not trust the ZyWALL/USG certificate, the browser will display a warning page of security certificate problems.

Go to ZyWALL/USG **CONFIGURATION > Object > Certificate > default > Edit** to export default certificate from ZyWALL/USG with Private Key (zyx123 in this example).

### CONFIGURATION > Object > Certificate > default

#	Name	Type	Subject	Issuer	Valid From	Valid To
1	default	SELF	CN=vpn300_B8ECA3A9C...	CN=vpn300_B8ECA3A9C...	2017-04-25 12:41:25 GMT	2027-04-23 12:41:25 GMT

### CONFIGURATION > Object > Certificate > default > Edit > Export Certificate with Private Key

Issuer: CN=vpn300\_B8ECA3A9C003  
 Signature Algorithm: rsa-pkcs1-sha256  
 Valid From: 2017-04-25 12:41:25 GMT  
 Valid To: 2027-04-23 12:41:25 GMT  
 Key Algorithm: rsaEncryption (2048 bits)  
 Subject Alternative Name: vpn300\_B8ECA3A9C003  
 Key Usage: DigitalSignature, KeyEncipherment, DataEncipherment, KeyCertSi  
 Extended Key Usage:  
 Basic Constraint: Subject Type=CA, Path Length Constraint=1  
 MD5 Fingerprint: 1b:a9:ff:f3:e6:42:44:9c:90:8d:bc:3e:f9:07:af:26  
 SHA1 Fingerprint: 1b:dd:6e:b2:c7:89:2e:ea:43:a0:ee:d2:55:3a:ff:15:89:bc:64:70

**Certificate in PEM (Base-64) Encoded Format**  
 -----BEGIN X509 CERTIFICATE-----  
 MIIDSzCCAjOgAwIBAgIJAP0XXinyW6C/MA0GCSqGSIb3DQEBCwUAMB4xHDAaBgNV  
 BAMME3ZwbjMwMF9COEVDQTNBOUMwMDMwHhcNMTcwNDI1MTI0MTI1WhcNMjcw  
 NDlz

Password:

Save default certificate as \*.p12 file to Windows 7 Operation System.



default.p12

In Windows 7 Operating System **Start Menu > Search Box**, type **mmc** and press **Enter**.

**Start Menu > Search Box > mmc**

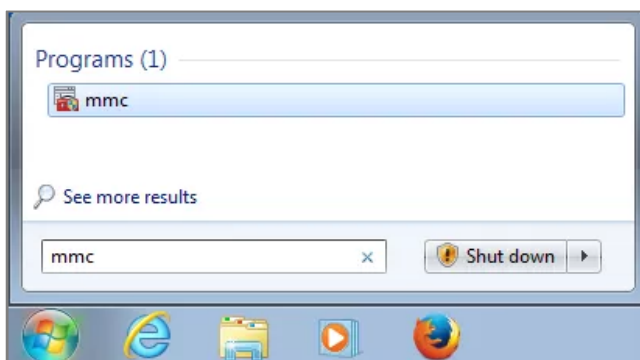

In the mmc console window, click **File > Add/Remove Snap-in...**

**File > Add/Remove Snap-in...**

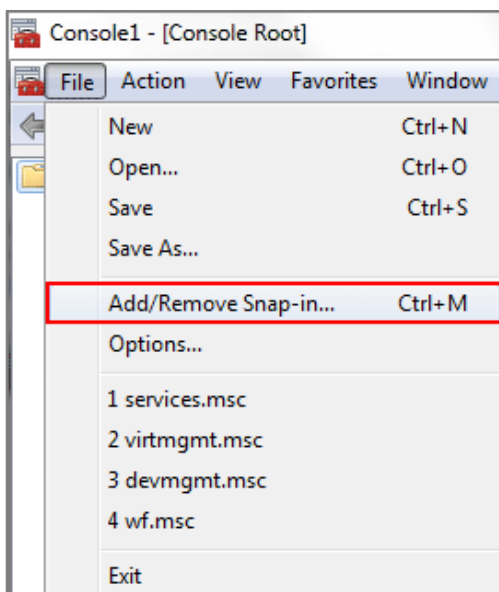

In the **Available snap-ins**, select the **Certificates** and click **Add** button. Select **Computer account > Local Computer**. Then, click **Finished** and **OK** to close the **Snap-ins** window.

### Available snap-ins > Certificates > Add

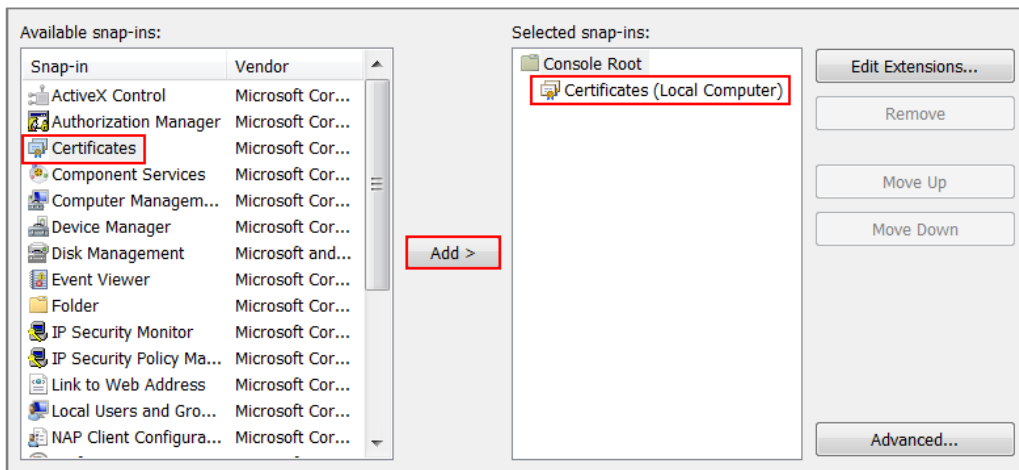

In the mmc console window, open the **Certificates (Local Computer) > Trusted Root Certification Authorities**, right click **Certificate > All Tasks > Import...**

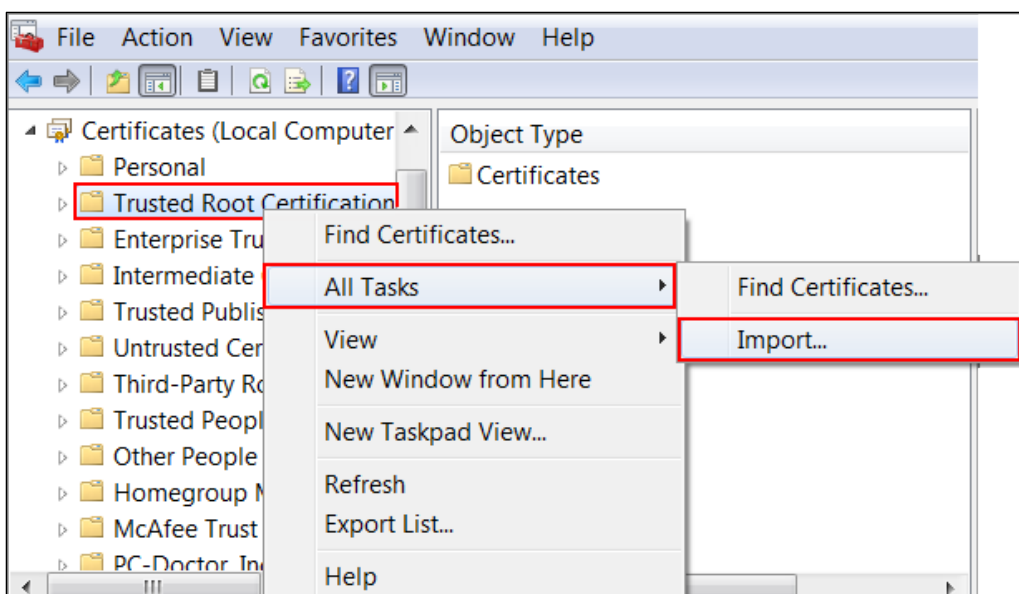

Click **Next**. Then, **Browse...**, and locate the .p12 file you downloaded earlier. Then, click **Next**.

**File to Import**  
Specify the file you want to import.

---

File name:  
C:\Users\Desktop\default.p12

Note: More than one certificate can be stored in a single file in the following formats:

- Personal Information Exchange- PKCS #12 (.PFX,.P12)
- Cryptographic Message Syntax Standard- PKCS #7 Certificates (.P7B)
- Microsoft Serialized Certificate Store (.SST)

Click **Next**, type **zyx123** in the **Password** field and click **Next** again

**Password**  
To maintain security, the private key was protected with a password.

---

Type the password for the private key.

Password:

Enable strong private key protection. You will be prompted every time the private key is used by an application if you enable this option.

Mark this key as exportable. This will allow you to back up or transport your keys at a later time.

Include all extended properties.



Select **Place all certificates in the following store** and then click **Browse** and find **Trusted Root Certification Authorities**. Click **Next**, then click **Finish**.

**Certificate Store**

Certificate stores are system areas where certificates are kept.

---

Windows can automatically select a certificate store, or you can specify a location for the certificate.

Automatically select the certificate store based on the type of certificate

Place all certificates in the following store

Certificate store:

 Note: Each ZyWALL/USG device has its own self-signed certificate by factory default. When you reset to default configuration file, the original self-signed certificate is erased, and a new self-signed certificate will be created when the ZyWALL/USG boots the next time.

## Test the Result

Type <http://www.bittorrent.com/> or <http://us.battle.net/d3/en/> into the browser.

The error message occurs.

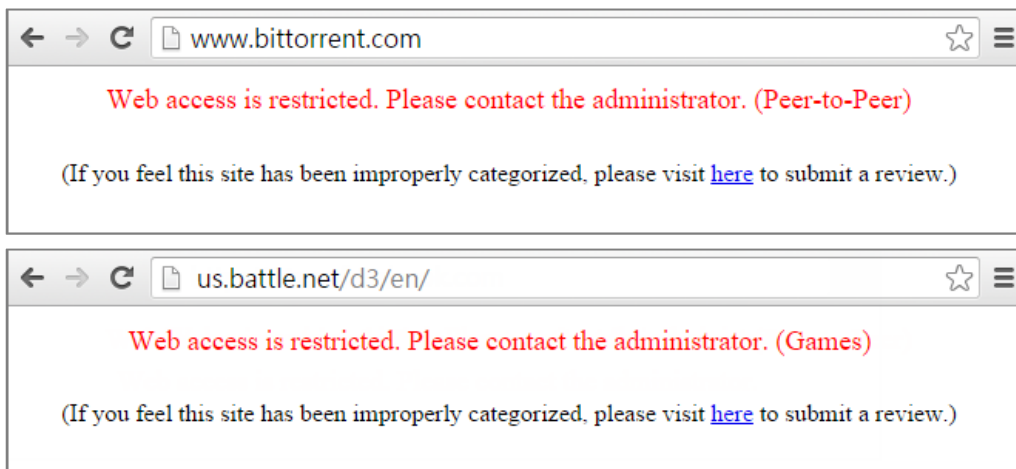

Go to the ZyWALL/USG **Monitor > Log** to see [alert] log message such as below.

### Monitor > Log

Priority	Category	Message	Note
alert	Blocked web sites	www.bittorrent.com : Peer-to-Peer, Rule_id=1, SSI=N	WEB BLOCK
alert	Blocked web sites	us.battle.net : Games, Rule_id=1, SSI=N	WEB BLOCK

## What Could Go Wrong?

If you are not be able to configure any **Content Filter** policies or it's not working, there are two possible reasons:

You have not subscribed for the **Content Filter** service.

You have subscribed for the **Content Filter** service but the license is expired.

You can click the link from the **CONFIGURATION > Licensing > Registration** screen of your ZyXEL device's Web Configurator or click the myZyXEL.com 2.0 icon from the portal page (<https://portal.myzyxel.com/>) to register or extend your **Content Filter** license.

## How To Block the Spotify Music Streaming Service

This is an example of using a ZyWALL/USG IDP Profile to block DNS query packet. When the Spotify software launches, it will send a DNS query for Spotify's public server. In this example, you can create a custom IDP to block DNS query packet if this packet includes the Spotify signature.

ZyWALL/USG with Block the Spotify Service Example

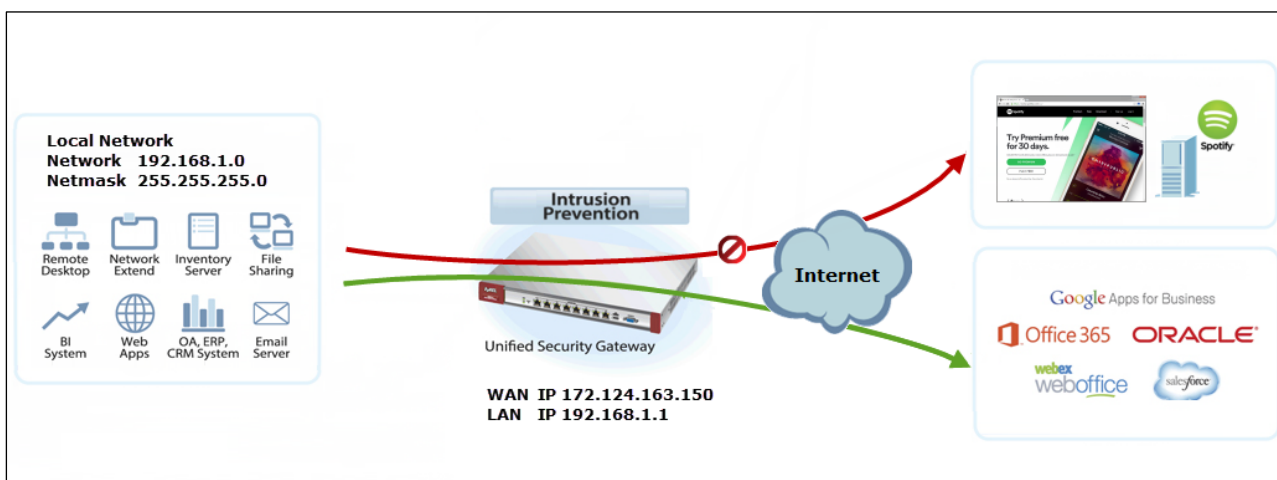

 Note: All network IP addresses and subnet masks are used as examples in this article. Please replace them with your actual network IP addresses and subnet masks. This example was tested using USG310 (Firmware Version: ZLD 4.25).

## Set Up IDP Profile on the ZyWALL/USG

In the ZyWALL/USG, go to **CONFIGURATION > UTM Profile > IDP > Custom Signatures > Add Custom Signatures**, configure a **Name** for you to identify the IDP Profile. Select **medium** as the **Severity** level. Select all **Platform**. Select **Policy Type** to be **Access-Control** here to limit access network resources such as servers.

**CONFIGURATION > Security Policy > IDP > Custom Signatures > Add Custom Signatures > Setup & Information**

**Setup**

Name: Spotify  
Signature ID: 9986234

**Information**

Severity: medium

Platform:
  Windows
  Linux
  FreeBSD
  Solaris  
 Other-Unix
  Network-Device
  MAC
  iOS  
 Android
  Windows-Mobile
  Symbian
  Others

Policy Type: Access-Control

Scroll down to the **Payload Options** section, the type Spotify's software signature: |73||70||6F||74||69||66||79| into the **Content** field. Click **OK**.

**CONFIGURATION > Security Policy > IDP > Custom Signatures > Add Custom Signatures > Payload Options**

**Payload Options**

Payload Size: [ ] Bytes

#	Offset	Content	Case-insensitive	Decode as URI
1	0	73  70  6F  74  69  66  79	no	no

In the ZyWALL/USG, go to **CONFIGURATION > UTM Profile > IDP > Profile > Base Profile**. A pop-up screen will appear and select a **Base Profile** to go to the profile details screen.

**CONFIGURATION > UTM Profile > IDP > Profile > Base Profile**

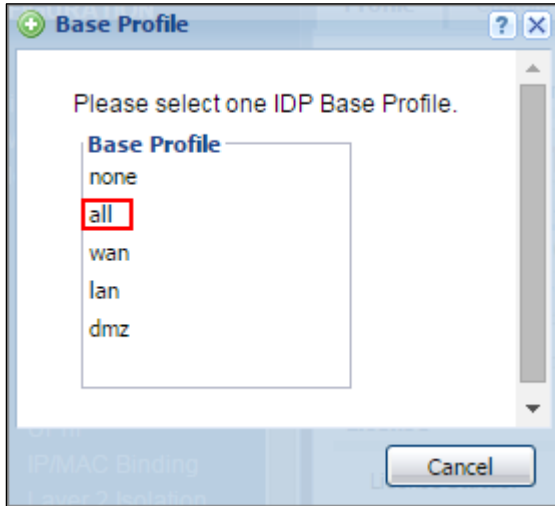

Configure a **Name** for you to identify the **IDP** Profile. **Activate** the newly created IDP Profile and select **Action** to be **drop**. Select **Log** type to be **log alert** in order to view the result later.

**CONFIGURATION > UTM Profile > IDP > Profile > Base Profile > Add Profile**

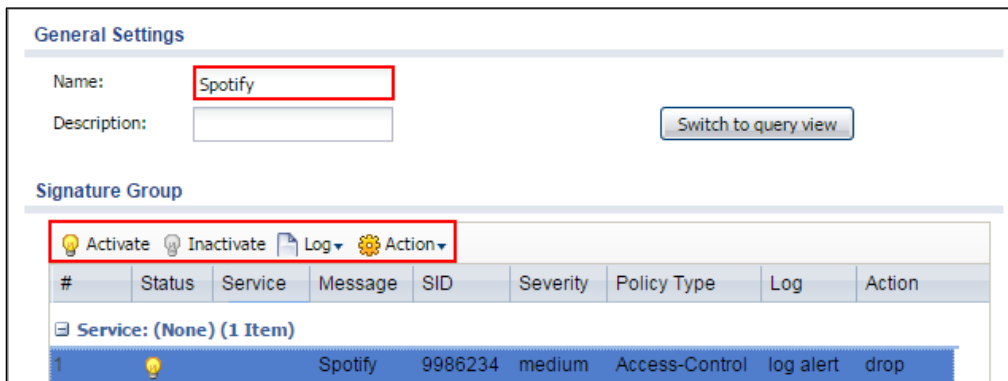

## Test the Result

Type <http://www.spotify.com/> or [https://www.spotify.com /](https://www.spotify.com/) into the browser, the error message occurs.

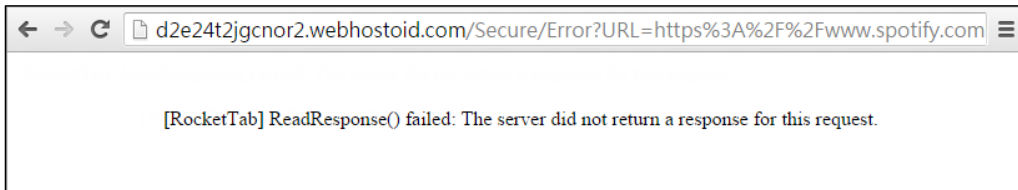

Go to the ZyWALL/USG **Monitor > Log**, you will see [crit] log message such as below.

### Monitor > Log

Priority	Category	Message	Note
crit	IDP	Rule_id=1 SSL=Y [type=custom-signature(9986234)] Spotify Action: Drop Packet Severity: medium	ACCESS BLOCK

## What Could Go Wrong?

If you are not be able to configure any **IDP** policies or it's not working, there are two possible reasons:

You have not subscribed for the **IDP** service.

You have subscribed for the **IDP** service but the license is expired.

You can click the link from the **CONFIGURATION > Licensing > Registration** screen of your ZyXEL device's Web Configurator or click the myZyXEL.com 2.0 icon from the portal page (<https://portal.myzyxel.com/>) to register or extend your

**Application Patrol** license.

## How does Anti-Malware work

There are many virus exist on the internet. And it may auto-downloaded on unexpected situation when you surfing between websites. The Anti-Malware is a good choose to protecting your computer to downloads unsafe application or files.

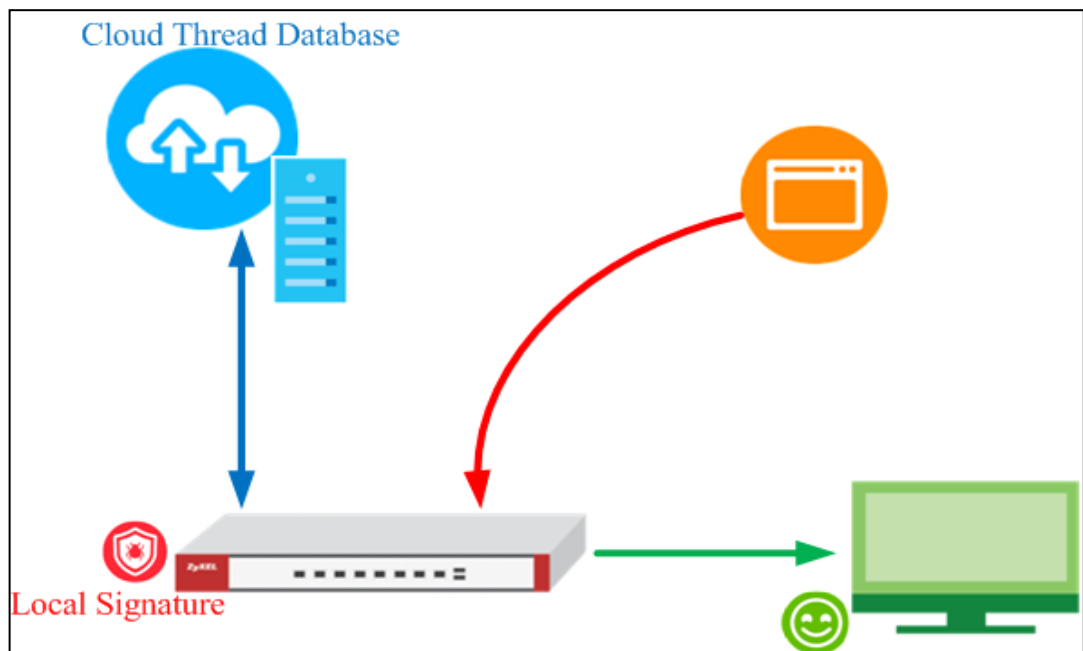

After you enabled Anti-Malware function, it will enabled “**Cloud Threat Database**” and “**Anti-Malware Signature**” in the same time.

The **Cloud Threat Database** is means your downloaded files will decompressed by device first, and then check files with cloud data base server if it exist unsafe file or not.

The **Anti-Malware Signature** is means your downloaded files will checked by local signatures that exist on device itself. It is helpful when your device unable access to internet at that moment.

 Note: In the default setting, the **Cloud Threat Database** is enabled and with higher priority when scanning the files.



## Enable Anti-Malware function to protecting your traffic

Go to **CONFIGURATION > Security Service > Anti-Malware** > Tick in **enable** checkbox to enable Anti-Malware function.

**Configuration > Security Service > Anti-Malware** > Tick in **enable** checkbox

The screenshot shows the ZyXel web interface for Anti-Malware configuration. The 'General Settings' section has the 'Enable' checkbox checked and highlighted with a red box. Below it, 'Scan and detect EICAR test virus' is also checked. The 'Actions When Matched' section includes 'Destroy infected file' (checked), a 'Log' dropdown set to 'log', and 'Check White List' (checked). There are two tables for White List and Black List, both showing 'No data to display'. The 'File decompression' section has 'Enable file decompression (ZIP and RAR)' checked and 'Destroy compressed files that could not be decompressed' unchecked. The 'Signature Information' section lists details for 'Anti-Malware' (Current Version: 3.0.1.20180327.0, Signature Number: 404077, Released Date: 2018-03-27 01:32:19) and 'Cloud Threat Database' (Current Version: 1.0.0.20180226.0, Signature Number: 20001, Released Date: 2018-02-25 18:15:02). At the bottom, there are 'Apply' and 'Reset' buttons.

 Note: The Anti-Malware license is required. So you must enabled Anti-Malware function on your myzyxel.com account.

## Test the result

After you enabled Anti-Malware function and your PC downloaded the virus file from internet. You device will detected it and drop the file directly.

Then your file is unable opened or replaced by "0".

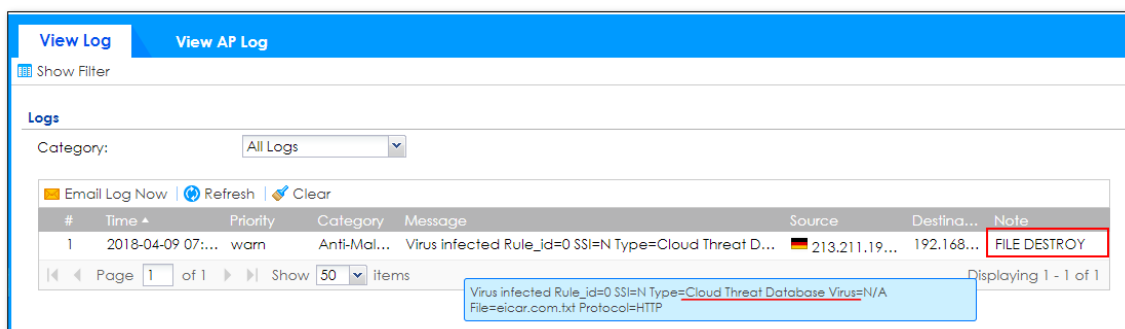

## Additional configuration

**White List:** You can use wildcard to allowing specific type files.

**Black List:** You can use wildcard to drop specific type files.

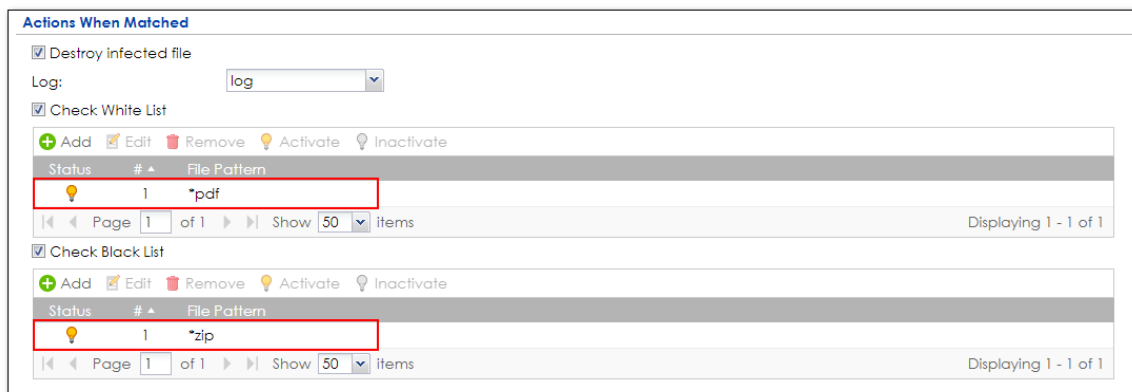

**Logs**

Category:

Email Log Now | Refresh | Clear

#	Time	Priority	Categ...	Message	Source	Destination	Note
2	2018-04-0...	info	Anti-M...	FTP, NWA1123-ACv2_5.20(ABEL.4)C0_2.pdf matched the <u>White-List *pdf</u>	66.85.12...	192.168.1...	
1	2018-04-0...	info	Anti-M...	HTTP, elcar_com.zip matched the <u>Black-List *zip</u>	213.211....	192.168.1...	

Page 1 of 1 | Show 50 items | Displaying 1 - 2 of 2

## What can go wrong

- 1 The Anti-Malware service license is required
- 2 The Anti-Malware is able decompress the file. But it is not support multi-layer zip files.
- 3 In the default setting, could thread batabase is enabled. You can use the CLI command to activate/deactivate cloud base service. It means the scanning priority will be changed.
  - a. **Router(config)# debug anti-virus ctdb activate**
  - b. **Router(config)# debug anti-virus ctdb deactivate**

## How to Configure an Email Security Policy with Mail Scan and DNSBL

This is an example of using ATP Series' UTM Profile to mark or discard spam (unsolicited commercial or junk e-mail). Use the Email Security white list to identify legitimate e-mail. Use the Email Security black list to identify spam e-mail. The ATP Series can also check e-mail against a DNS Black List (DNSBL) of IP addresses of servers that are suspected of being used by spammers.

ATP Series with Email Security Profile to mark or discard spam e-mail  
Example



**Figure 1** Using Email Security to Detect Spam

 Note: All network IP addresses and subnet masks are used as examples in this article. Please replace them with your actual network IP addresses and subnet masks. This example was tested using ATP200 (Firmware Version: ZLD 4.32).

## Set Up the Email Security on ATP Series

In the ATP Series, go to **CONFIGURATION > Security Service > Email Security**; Enable this feature on General Settings page. Select **Check IP Reputation (SMTP only)** to have the ATP Series scan for spam e-mail by IP Reputation. Select **Check Mail Content** to identify Spam Email by content, such as malicious content. Select **Check Virus Outbreak** to scan viruses attached in emails. On advance section, leave Query Timeout Settings to be the default settings.

Select from the list of available **Scan Options** and desired Log type whether to have the ATP Series generate a log (**log**), log and alert (**log alert**) or neither (**no**) by default when traffic matches this policy. Click **Apply** to save the configuration

## CONFIGURATION > Security Service > Email Security

Enable

Check White List  
 Check Black List  
 Check IP Reputation (SMTP only)  
 Check Mail Content  
 Check Virus Outbreak  
 Check Mail Phishing  
 Check DNSBL

Black List Spam Tag:  (Optional)  
 Mail Content Spam Tag:  (Optional)  
 Virus Outbreak Tag:  (Optional)  
 Mail Phishing Tag:  (Optional)  
 DNSBL Spam Tag:  (Optional)

**DNSBL Domain List**

[+ Add](#) [Edit](#) [Remove](#) [Activate](#) [Inactivate](#)

Status	#	DNSBL Domain
Page 0 of 0 Show 50 items No data to display		

**Action**

Actions For Spam Mail ⓘ

SMTP:   
 POP3:   
 Log:  ⓘ

Action taken when mail session threshold is reached

Forward Session

1. Register the device to myZyxel.com.
2. Activate Application Security.

#	Service	Status	Service Type	Expiration Date	Count	Action
1	Web Security	Activated	Standard	2019-5-13	N/A	<a href="#">Renew</a>
2	Application Security	Activated	Standard	2019-5-13	N/A	<a href="#">Renew</a>
3	Malware Blocker	Activated	Standard	2019-5-13	N/A	<a href="#">Renew</a>
4	Intrusion Prevention	Activated	Standard	2019-5-13	N/A	<a href="#">Renew</a>
5	Geo Enforcer	Activated	Standard	2019-5-13	N/A	<a href="#">Renew</a>
6	Sandboxing	Activated	Standard	2019-5-13	N/A	<a href="#">Renew</a>
7	SecuReporter	Activated	Standard	2019-5-13	N/A	<a href="#">Renew</a>
8	Managed AP Service	Activated	Standard	2019-5-13	8	<a href="#">Renew</a>
9	Firmware Upgrade Service	Activated			N/A	

Page 1 of 1 Show 50 items Displaying 1 - 9 of 9

- Go to **CONFIGURATION > Security Service> Email Security>Enable Check Black List** to have the ATP Series treat e-mail that matches (an active) black list entry as spam.

**General Settings** Email Security

Enable

Check White List

Check Black List

Black List Spam Tag:  (Optional)

- Continue to **Rule Summary on Black/White List**, click the **Add** icon. A pop-up screen will appear allowing you to configure **Content (Subject, IP/IPv6 Address, E-Mail Address and Mail Header)**, Use wildcards (\*) to configure **Mail Subject Keyword**. (\*sell\* in this example). Click **OK** to return to the **General** screen.

### CONFIGURATION > Security Service> Black/White List

**+ Add Rule** ? X

Enable Rule

Type:  ▼

Mail Subject Keyword:

- In the ATP Series, go to **CONFIGURATION > Security Service> Email Security>Enable Check DNSBL**  
Press Add and enter the **DNSBL Domain** for a DNSBL service (zen.spamhaus.org in this example). Click **Apply**.

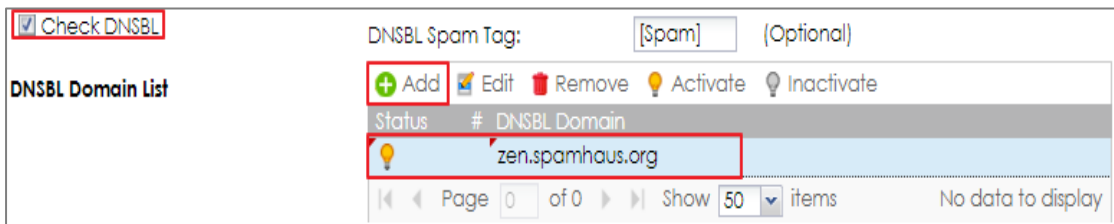

## Test the result

1. Send the mail subject with "sell".

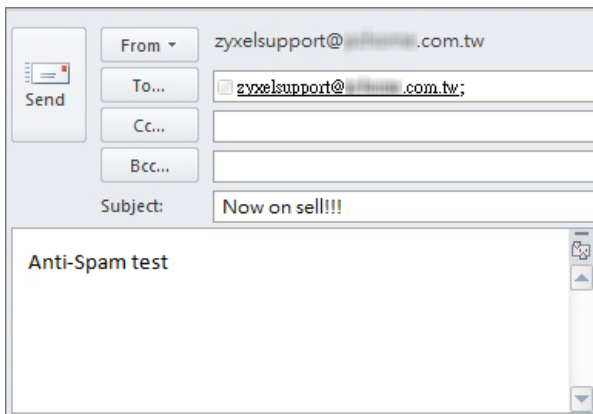

2. You will receive the mail subject with [Spam] tag.

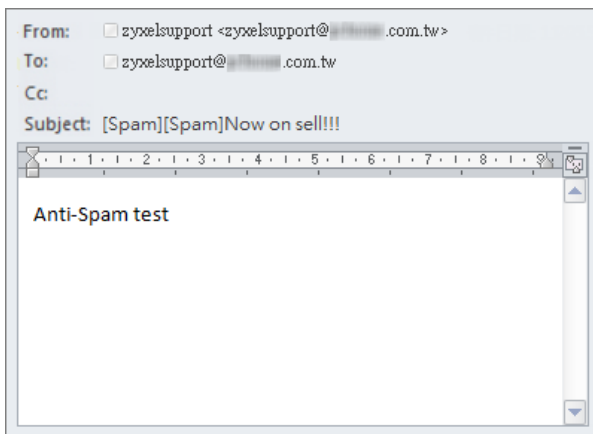

## What can go wrong

1. If Email Security is not working, there are two possible reasons:
  - You have not subscribed for the **Email Security** service.
  - You have subscribed for the **Email Security** service but the license (**Application Security**) is expired.
2. You can click the link from the **CONFIGURATION > Licensing > Registration** screen of your ZyXEL device's Web Configurator or click the myZyXEL.com 2.0 icon from the portal page (<https://portal.myzyxel.com/>) to register or extend your **Application Security** license.



## How to Configure Botnet Filter on ATP series?

Botnets are organized groups of infected computers. Those infected PCs will try to connect to the command-and-control server and ask for commands. When the attacker sends command to the command-and-control server, it will relay those commands to the clients (infected computers) and perform attacks on particular targets.

The following steps will walk you through an example of how to configure Botnet Filter (IP blocking and URL blocking) on the ATP.

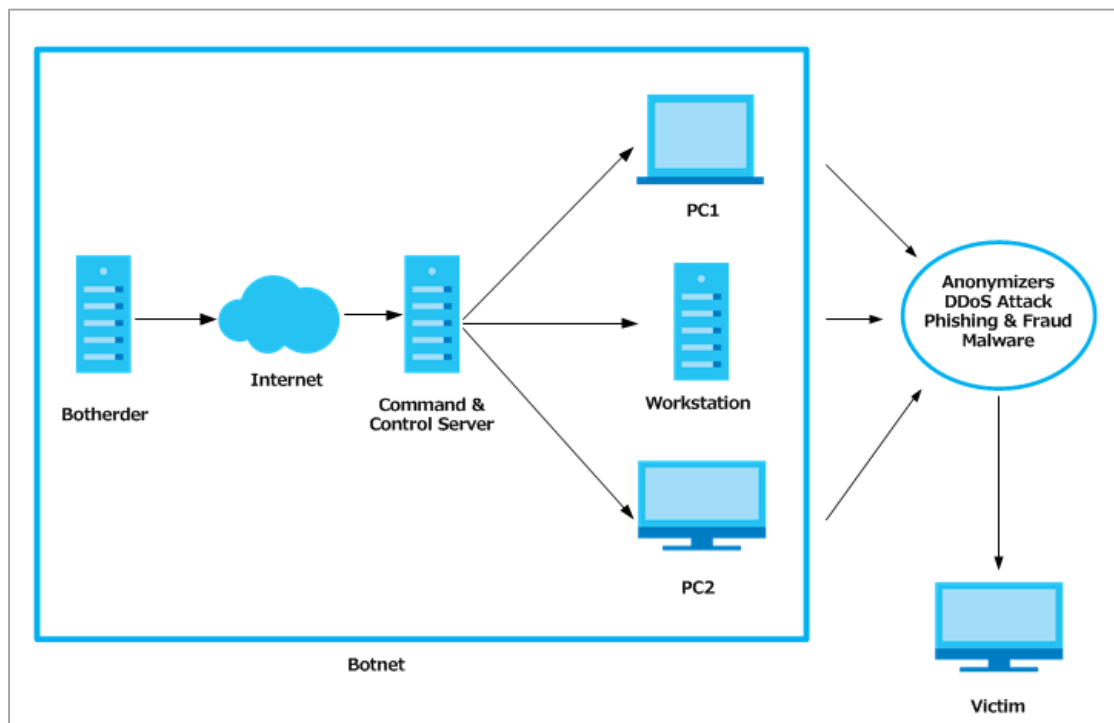

## Prerequisites before setting up Botnet Filter function

1. License status check
2. Update the Botnet Filter signature

## License activation

Before setting up the Botnet Filter function, users need to make sure their licenses are purchased and activated.

To check the license activation status:

Go to configuration > Licensing > Registration > Service and check on the “Application Security” service which includes the Botnet Filtering function.

Registration		Service		Service Status			
#	Service	Status	Service Type	Expiration Date	Count	Action	
1	Web Security	Activated	Standard	2019-5-13	N/A	<a href="#">Renew</a>	
2	Application Security	Activated	Standard	2019-5-13	N/A	<a href="#">Renew</a>	
3	Malware Blocker	Activated	Standard	2019-5-13	N/A	<a href="#">Renew</a>	
4	Intrusion Prevention	Activated	Standard	2019-5-13	N/A	<a href="#">Renew</a>	
5	Geo Enforcer	Activated	Standard	2019-5-13	N/A	<a href="#">Renew</a>	
6	Sandboxing	Activated	Standard	2019-5-13	N/A	<a href="#">Renew</a>	
7	SecuReporter	Activated	Standard	2019-5-13	N/A	<a href="#">Renew</a>	
8	Managed AP Service	Activated	Standard	2019-5-13	8	<a href="#">Renew</a>	
9	Firmware Upgrade Service	Activated			N/A		

Page 1 of 1 | Show 50 Items | Displaying 1 - 9 of 9

## Update Botnet Filter Signatures

To make sure the device has the most updated signature, we suggest users to update their Botnet Filter signature before using this function.

To update the Botnet Filter signature:

Go to **Configuration > Security Service > Botnet Filter**. Then click **“Update Signatures”**

**Signature Information**









Current Version: 1.0.1.20180703.0

Signature Number: 200000

Released Date: 2018-07-03 10:07:39

[Update Signatures](#)

Then the device will redirect users to the “**Service Status**” page. Click on the cloud icon  and the device will start signature downloading process

Signature					
Service Status					
Feature	Type	Current Version	Released Date	Last Sync	Action
Anti-Malware	Anti-Malware Signature	2.0.1.20180627.0	2018-06-27 09:31:58 (UTC+08:00)	2018-07-04 23:55:01	 
	Cloud Threat Databa...	1.0.0.20180704.0	2018-07-04 02:15:03 (UTC+08:00)		
App-Patrol	App-Patrol	1.0.0.20180517.0	2018-05-17 09:45:17 (UTC+08:00)	2018-06-20 04:52:18	 
IDP	IDP	4.0.1.20180626.0	2018-06-26 13:10:00 (UTC+08:00)	2018-07-01 00:27:01	 
Botnet Filter	Botnet Filter	1.0.1.20180703.0	2018-07-03 10:07:39 (UTC+08:00)	2018-07-05 02:59:01	 

Once the signature updating process was done. The GUI will pop up the following message to notify users.

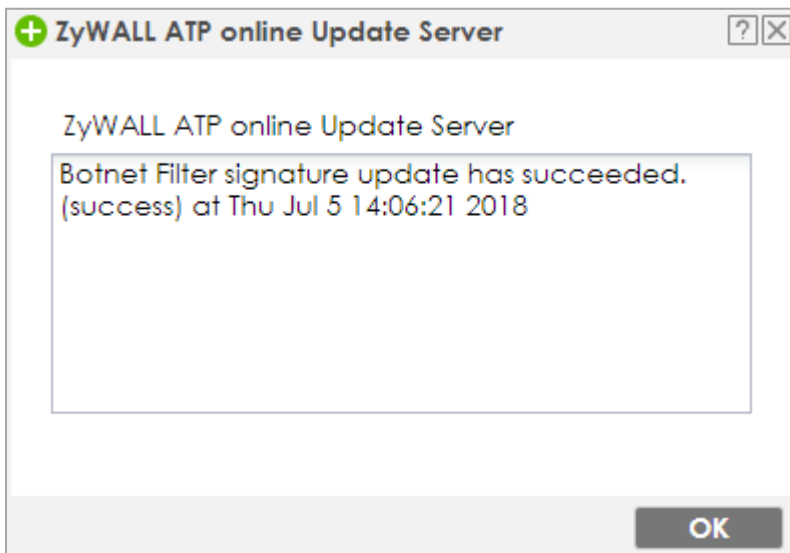

Now the Botnet Filtering function is ready to go.

## Set Up the IP Blocking on the ATP series

Go to **Configuration > Security Service > Botnet Filter**.

Select the **Enable IP Blocking** check box. There're some actions can be selected "reject-both", user can decide if they'd like to "forward", "reject-sender" or "reject-receiver" the blocked IP . In addition, users can select if they want to log the related events or not.

The screenshot shows the 'Botnet Filter' configuration page. Under the 'IP Blocking' section, the 'Enable' checkbox is checked. The 'Action' dropdown menu is set to 'reject-both', and the 'Log' dropdown menu is set to 'log'. Red boxes highlight these three elements.

## Test the Result

User access IP: 5.9.32.230

Go to **Monitor > Security Statistics > Botnet Filter** to check summary.

IP: 5.9.32.230 is blocked due to command & control.

The screenshot shows the 'Summary' page of the Botnet Filter. Under 'General Settings', the 'Collect Statistics' checkbox is checked. Below this, there are buttons for 'Apply', 'Reset', 'Refresh', and 'Flush Data'. The 'Summary' section displays statistics: IP Scanned: 16, IP Hit Count: 9, URL Scanned: 0, and URL Hit Count: 0. The 'IP Detected' section contains a table with the following data:

Time	Source IP	Botnet IP	Threat Category
2018/04/11 09:58:32	192.168.1.33	5.9.32.230:80	command & control
2018/04/11 09:58:32	192.168.1.33	5.9.32.230:80	command & control
2018/04/11 09:58:32	192.168.1.33	5.9.32.230:80	command & control
2018/04/11 09:58:31	192.168.1.33	5.9.32.230:80	command & control

## Set up the URL Blocking on the ATP series

Go to **Configuration > Security Service > Botnet Filter**.

Select the **Enable URL Blocking** check box, check the categories that need to be blocked. Users can only check those categories as their requirement. Choose the Action the device will take (In this example we select "block" to block certain URLs) and if they want to Log those events on the device.

**URL Blocking**

Enable

Anonymizers       Botnet C&C       Compromised  
 Malware       Phishing & Fraud       Spam Sites

Action:

Log:

Message to display when a site is blocked

Denied Access Message:

Redirect URL:

## Test the Result

Browse the Phishing website URL from the host browser. Users will be redirected to an error page in the browser that notifies users they are visiting to the "Phishing & Fraud" categorized URL

← → ↻ 🏠 [websectest.ctmail.com/31\\_Phishing\\_and\\_Fraud.htm](http://websectest.ctmail.com/31_Phishing_and_Fraud.htm)

Web access is restricted. Please contact the administrator. (Phishing & Fraud)

(If you feel this site has been improperly categorized, please visit [here](#) to submit a review.)

Go to **Monitor > Security Statistics > Botnet Filter** to check summary where users will see the related threat log was recorded

**Summary**

**General Settings**

Collect Statistics since 2018-04-11 10:03:39 to 2018-04-11 10:08:04

[Apply](#) [Reset](#) [Refresh](#) [Flush Data](#)

**Summary**

IP Scanned: 0  
IP Hit Count: 0  
URL Scanned: 80  
URL Hit Count: 2

**IP Detected**

Time	Source IP	Botnet IP	Threat Category
No data to display			

**URL Detected**

Time	Source IP	Botnet URL	Threat Category
Apr 11 10:03:52 2018	192.168.1.33	websectest.ctmail.com/31_Phishi...	Phishing & Fraud
Apr 11 10:03:43 2018	192.168.1.33	websectest.ctmail.com/42_Malw...	Malware

Page 1 of 1 Show 50 items Displaying 1 - 2 of 2

## How to Use Sandboxing to Detect Unknown Malware

The traditional security service such as Anti-Virus and IDP are signature-based solution, so they have no chance to detect unknown threats. ZyWALL ATP enhances UTM service and integrates Sandbox solution as a second layer of defense to detect and mitigate advanced threats. Zyxel Sandbox is a cloud-based service that can identify previously unknown malware. Each new threat discovered by Sandbox will be converted to known signatures in the cloud threat database of Anti-Malware. The Anti-Malware examines file for threats before deciding to block or pass to Sandbox. If the file has never been inspected by Sandbox, ZyWALL ATP copies this file to the caches and then forwards the file. A copy of the file is sent to Sandbox for analysis and the analysis result is recorded on device's local cache. Once ZyWALL ATP detects the file again, it can identify the file and take the action based on the previous analysis result on local cache. With the cooperation of Anti-Malware, ATP can immediately block threat which previous detected by Sandbox. This example illustrates how to configure Sandboxing on ATP gateway to detect unknown malware.

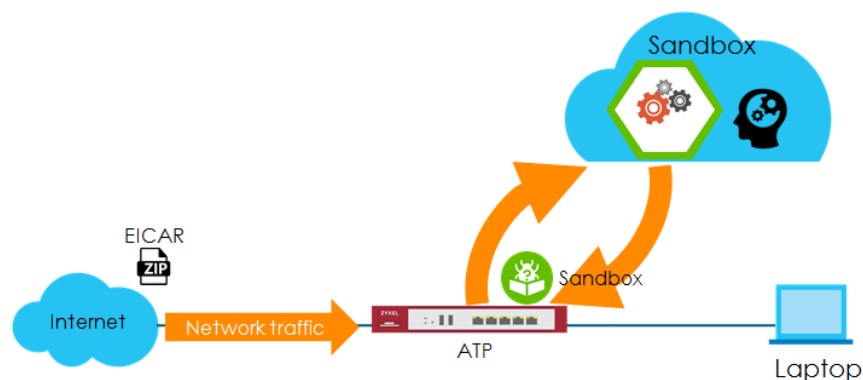

**Figure 1** Using Sandboxing to Detect Unknown Malware

 Note: All network IP addresses and subnet masks are used as examples in this article. Please replace them with your actual network IP addresses. This example was tested using the ATP200 (Firmware Version: ZLD 4.32).

## Set Up Sandboxing on ATP

1. Register the device to myZyxel.com.
2. Activate Sandboxing license.

Service Status						
#	Service	Status	Service Type	Expiration Date	Count	Action
1	Web Security	Activated	Standard	2019-4-28	N/A	<a href="#">Renew</a>
2	Application Security	Activated	Standard	2019-4-28	N/A	<a href="#">Renew</a>
3	Malware Blocker	Activated	Standard	2019-4-28	N/A	<a href="#">Renew</a>
4	Intrusion Prevention	Activated	Standard	2019-4-28	N/A	<a href="#">Renew</a>
5	Geo Enforcer	Activated	Standard	2019-4-28	N/A	<a href="#">Renew</a>
6	Sandboxing	Activated	Standard	2019-4-28	N/A	<a href="#">Renew</a>
7	SecuReporter	Activated	Standard	2019-4-28	N/A	<a href="#">Renew</a>
8	Managed AP Service	Activated	Standard	2019-4-28	18	<a href="#">Renew</a>
9	Firmware Upgrade Service	Activated			N/A	

Page 1 of 1 Show 50 Items Displaying 1 - 9 of 9

3. In the ATP, go to **CONFIGURATION > Security Service > Sandboxing > File Submission Options**, the default supported file types are listed.

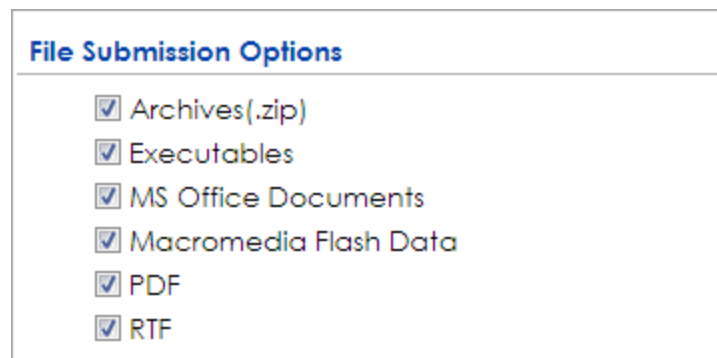

Use the command to check the status of each file type. If the status is "no", the file type is not scanned by Sandboxing.

**Router> show sandbox file-type all**



```
Router> show sandbox file-type all
```

No.	Show_name	Name	Status
1	Archives(.zip)	archives	yes
2	CHM	chm	no
3	EICAR	eicar	no
4	Executables	executables	yes
5	Macromedia Flash Data	macromedia-flash-data	yes
6	MS Office Documents	ms-office-document	yes
7	PDF	pdf	yes
8	RTF	rtf	yes
9	Unknow Type	unknow-type	no

Use the following commands to make Sandboxing access and check a certain file type.

```
Router> configure terminal
```

```
Router(config)# sandbox file-type eicar
```

```
Router(config)# write
```

```
Router> configure terminal
Router(config)# sandbox file-type eicar
Router(config)# write
Router(config)# show sandbox file-type all
```

No.	Show_name	Name	Status
1	Archives(.zip)	archives	yes
2	CHM	chm	no
3	EICAR	eicar	yes
4	Executables	executables	yes
5	Macromedia Flash Data	macromedia-flash-data	yes
6	MS Office Documents	ms-office-document	yes
7	PDF	pdf	yes
8	RTF	rtf	yes
9	Unknow Type	unknow-type	no

4. Go to **CONFIGURATION > Security Service > Sandboxing > General**, enable Sandboxing and select action and log for malicious and suspicious files to monitor the result.

**General**

Enable Sandboxing

Action For Malicious File:

Log For Malicious File:

Action For Suspicious File:

Log For Suspicious File:

5. Enable Collect Statistics to monitor the scan results and statistics.

### MONITOR > Security Statistics > Sandboxing

**General Settings**

Collect Statistics since 2018-07-03 10:41:08 to 2018-07-03 10:41:08

**Submission Summary**

Total:	0
Scanning:	0
Scanned:	0
Destroyed Files:	0

**Scan Result**

Malicious Files:	0
Suspicious Files:	0
Safe Files:	0
Other:	0

**Statistics**

#	File Name	Hash	Type	Occurence	Update Time
<span>« Page 0 of 0 »</span> <span> Show 50 items</span> <span style="float: right;">No data to display</span>					

## Test the Result

- 4 Go to <http://www.eicar.org/85-0-Download.html> to download eicar\_com.zip file.

www.eicar.org/85-0-Download.html

**BE UP TO DATE  
RSS FEED**

Order eicar news and events as rss feed.

[EICAR News](#) [EICAR Events](#)

caused by the scanner which puts the file into quarantine. The test file will be treated just like any other real virus infected file. Read the user's manual of your AV scanner what to do or contact the vendor/manufacturer of your AV scanner.

**IMPORTANT NOTE**

EICAR cannot be held responsible when these files or your AV scanner in combination with these files cause any damage to your computer. **YOU DOWNLOAD THESE FILES AT YOUR OWN RISK.** Download these files only if you are sufficiently secure in the usage of your AV scanner. EICAR cannot and will not provide any help to remove these files from your computer. Please contact the manufacturer/vendor of your AV scanner to seek such help.

**Download area using the standard protocol http**

<a href="#">eicar.com</a> 68 Bytes	<a href="#">eicar.com.txt</a> 68 Bytes	<a href="#">eicar_com.zip</a> 184 Bytes	<a href="#">eicarcom2.zip</a> 308 Bytes
---------------------------------------	---	--	--

**Download area using the secure, SSL enabled protocol https**

<a href="#">eicar.com</a> 68 Bytes	<a href="#">eicar.com.txt</a> 68 Bytes	<a href="#">eicar_com.zip</a> 184 Bytes	<a href="#">eicarcom2.zip</a> 308 Bytes
---------------------------------------	---	--	--

- When you download eicar\_com.zip for the first time, it is considered to be an unknown malware. The file is allowed to pass and a copy of eicar\_com.zip will be sent to Sandbox for further scan.

**MONITOR > Log > View Log > Sandboxing**

View Log
View AP Log

Show Filter

**Logs**

Category:

Email Log Now | Refresh | Clear

#	Time	Priority	Category	Message	Source	Destination	Note
1	2018-04-...	alert	Sandbox	Malicious File name: eicar_com.zip, md5: 6ce6f4...	192.168.1.33:1...	213.211.198...	
2	2018-04-...	info	Sandbox	Query File name: eicar_com.zip, md5: 6ce6f415...	192.168.1.33:1...	213.211.198...	
134	2018-04-...	info	Sandbox	sandbox daemon Start OK...			
135	2018-04-...	info	Sandbox	dc connector Start OK			

Displaying 1 - 4 of 4

The eicar\_com.zip file is detected by Sandbox as a malicious file.

**MONITOR > Security Statistics > Sandboxing**

**Summary**

**General Settings**

Collect Statistics since 2018-04-27 16:55:12 to 2018-04-27 17:04:09

Apply
Reset
Refresh
Flush Data

**Submission Summary**

Total: 1

Scanning: 0

Scanned: 1

Destroyed File: 0

**Scan Result**

Malicious File: 1

Suspicious File: 0

Clean File: 0

Other: 0

**Statistics**

#	File Name	Hash	Type	Occurence	Update Time
1	eicar_com.zip	6ce6f415d8475545be5ba114f208b0ff	Malicious	1	2018-04-27 17:03:18

**Note:** Disable anti-virus software on your laptop in order to test Sandbox.

- 6 Download eicar\_com.zip file again. ZyWALL ATP destroyed the eicar\_com.zip file at the second time when you download the file and generate the log.

**MONITOR > Log > View Log > Sandboxing**

**View Log** View AP Log

Show Filter

**Logs**

Category: Sandbox

Email Log Now | Refresh | Clear

#	Time	Priority	Category	Message	Source	Destination	Note
1	2018-04-2...	crit	Sandbox	MALICIOUS infected SSIN File=eicar_com.z...	213.211.198...	192.168.1.33:1853	FILE DEST...
4	2018-04-2...	alert	Sandbox	Malicious File name: eicar_com.zip, md5: 6...	192.168.1.33:1845	213.211.198...	<span style="background-color: #007bff; color: white; padding: 2px 5px;">FILE DESTROY</span>
5	2018-04-2...	info	Sandbox	Query File name: eicar_com.zip, md5: 6ce6...	192.168.1.33:1845	213.211.198...	
137	2018-04-2...	info	Sandbox	sandbox daemon Start OK...			
138	2018-04-2...	info	Sandbox	dc connector Start OK			

Page 1 of 1 | Show 50 items | Displaying 1 - 5 of 5

**MONITOR > Security Statistics > Sandboxing**

604/774

**Summary**

---

**General Settings**

Collect Statistics since 2018-04-27 16:55:11 to 2018-04-27 17:11:14

Apply
Reset
Refresh
Flush Data

---

**Submission Summary**

Total: 2

Scanning: 0

Scanned: 2

Destroyed File: 1

---

**Scan Result**

Malicious File: 2

Suspicious File: 0

Clean File: 0

Other: 0

---

**Statistics**

#	File Name	Hash	Type	Occurence	Update Time
1	eicar_com.zip	6ce6f415d8475545be5ba114f208b0ff	Malicious	2	2018-04-27 17:08:26

⏪ Page 1 of 1 ⏩ Show 50 Items Displaying 1 - 1 of 1

## What Can Go Wrong?

- 7 SSL inspection needs to be enabled and applied to the corresponding security policy rule for HTTPS traffic.
- 8 Only Windows (Win XP, Win 7, Win 10) and Mac OSX operating system are supported.
- 9 The local cache of the analysis result will be deleted when the device reboots.

## How to Configure Bandwidth Management for FTP and HTTP Traffic

This is an example of using ZyWALL/USG Bandwidth Management (BWM) to control the bandwidth allocation for FTP and HTTP traffic. You can use source interface, destination interface, destination port, schedule, user, source, destination information, DSCP code and service type as criteria to create a sequence of specific conditions to allocate bandwidth for the matching packets. When the BWM is configured, you can limit bandwidth consuming services, such as FTP, while providing consistent HTTP service with bandwidth guarantees.

ZyWALL/USG with Bandwidth Management for HTTP and FTP Traffic Example

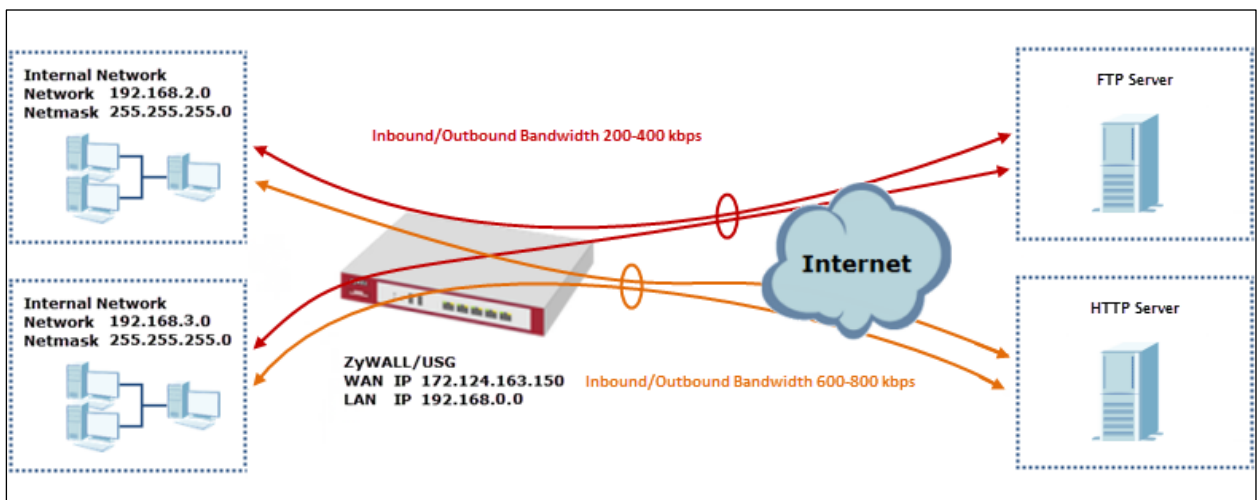

 Note: All network IP addresses and subnet masks are used as examples in this article. Please replace them with your actual network IP addresses and subnet masks. The total available bandwidth assumption is 1,600 kbps. This example was tested using USG310

## Set Up the Bandwidth Management for FTP on the ZyWALL/USG

In the ZyWALL/USG, go to **CONFIGURATION > BWM > Configuration > Add Policy**, select **Enable** and type **FTP Any-to-WAN** as the policy's **Description**.

Leave the **Incoming Interface** to **any** and select the Outgoing Interface to be **wan1**. Select **Service Type** to be the **Service Object** and select **FTP** from the list box.

Set the **Guaranteed Bandwidth Inbound** to 200 (kbps) and set **Priority 5** (low-to-medium). Set the **Maximum** to 400 (kbps). Set the **Guaranteed Bandwidth Outbound** to 200 (kbps) and set **Priority 5**. Set the **Maximum** to 400 (kbps).

In order to view the result later, set the **Log** setting to be **log alert**. Click **OK** to return to the **General** screen.

## CONFIGURATION > BWM > Configuration > Add Policy

**Configuration**

Enable

Description:  (Optional)

BWM Type:  Shared  Per user  Per-Source-IP ?

---

**Criteria**

User:

Schedule:

Incoming Interface:

**Outgoing Interface:**

Source:

Destination:

DSCP Code:

**Service Type:**

Service Object:

---

**DSCP Marking**

DSCP Marking

Inbound Marking:

Outbound Marking:

---

**Bandwidth Shaping**

Guaranteed Bandwidth	Inbound: <input type="text" value="200"/> kbps (0 : disabled)	Priority: <input type="text" value="5"/>
	<input type="checkbox"/> Maximize Bandwidth Usage	Maximum <input type="text" value="400"/> kbps
	Outbound: <input type="text" value="200"/> kbps (0 : disabled)	Priority: <input type="text" value="5"/>
	<input type="checkbox"/> Maximize Bandwidth Usage	Maximum <input type="text" value="400"/> kbps

---

**802.1P Marking**

Priority Code:  (0-7)

Interface:  ?

---

**Related Setting**

Log:



Note: In Bandwidth Management, the highest priority is (1) the lowest priority is (7).

## Set Up the Bandwidth Management for HTTP on the



## ZyWALL/USG

In the ZyWALL/USG, go to **CONFIGURATION > BWM > Configuration > Add Policy**, select **Enable** and type **HTTP Any-to-WAN** as the policy's Description (Optional).

Leave the **Incoming Interface** to **any** and select the Outgoing Interface to be **wan1**. Select **Service Type** to be the **Service Object** and select **HTTP** from the list box.

Set the **Guaranteed Bandwidth Inbound** to 600 (kbps) and set higher **Priority 3**. Set the **Maximum** to 800 (kbps). Set the **Guaranteed Bandwidth Outbound Priority 3**.

In order to view the result later, set the **Log** setting to be **log alert**. Click **OK** to return to the **General** screen.

**CONFIGURATION > BWM > Configuration > Add Policy**

**Configuration**

Enable

Description: HTTP Any-to-WAN (Optional)

BWM Type:  Shared  Per user  Per-Source-IP ⓘ

**Criteria**

User: any

Schedule: none

Incoming Interface: any

Outgoing Interface: ge1

Source: any

Destination: any

DSCP Code: any

Service Type: service-object

Service Object: HTTP

**DSCP Marking**

DSCP Marking

Inbound Marking: preserve

Outbound Marking: preserve

**Bandwidth Shaping**

Guaranteed Bandwidth

Inbound: 600 kbps (0 : disabled) Priority: 3

Maximize Bandwidth Usage Maximum: 800 kbps

Outbound: 600 kbps (0 : disabled) Priority: 3

Maximize Bandwidth Usage Maximum: 800 kbps

**802.1P Marking**

Priority Code: 0 (0-7)

Interface: none ⓘ

**Related Setting**

Log: log alert

 Note: In Bandwidth Management, the highest priority is (1) the lowest priority is (7).

## Set Up the Bandwidth Management Global Setting on the

## ZyWALL/USG

In the ZyWALL/USG, go to **CONFIGURATION > BWM > BWM Global Setting**, select **Enable**.

**CONFIGURATION > BWM > BWM Global Setting**





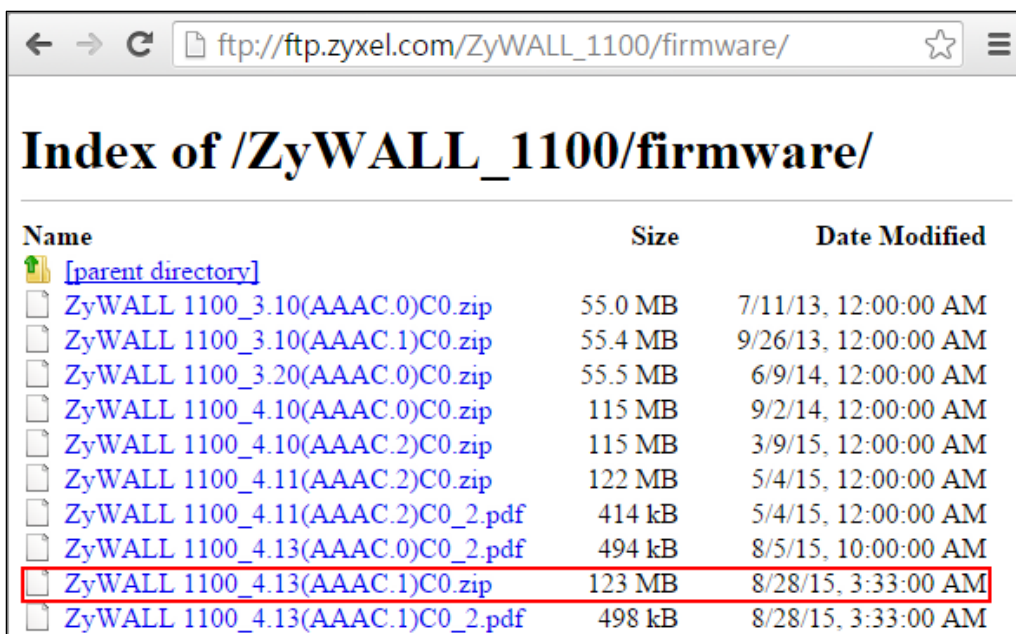

## Test the Result

Access the Internet to generate FTP traffic and HTTP traffic. In this example, a 123 MB file is downloading from an FTP server. The FTP file should download slowly.



Go to the ZyWALL/USG **Monitor > Log**, you will see [alert] log message such as below.

### Monitor > Log

Priority	Category	Message	Source	Destination
alert	BWM	Mode=port-base Rule=2 matched	192.168.1.33:51495	 216.241.54.88:54190
alert	BWM	Mode=port-base Rule=2 matched	192.168.1.33:51494	 216.241.54.88:21
alert	BWM	Mode=port-base Rule=2 matched	192.168.1.33:51493	 216.241.54.88:13700
alert	BWM	Mode=port-base Rule=2 matched	192.168.1.33:51492	 216.241.54.88:21

### What Could Go Wrong?

If the "outbound" in the guaranteed bandwidth settings apply to traffic going from the connection initiator to the outgoing interface. "Inbound" refers to the reverse direction.

## How to Limit BitTorrent or Other Peer-to-Peer Traffic

This is an example of using ZyWALL/USG Bandwidth Management (BWM) to control the bandwidth allocation for peer-to-peer traffic. You can use source interface, destination interface, destination port, schedule, user, source, destination information, DSCP code and service type as criteria to create a sequence of specific conditions to allocate bandwidth for the matching packets. When the BWM is configured, you can limit bandwidth consuming Application traffic, such as Peer-to-Peer (P2P) service.

ZyWALL/USG with Bandwidth Management for Peer-to-Peer Traffic Example

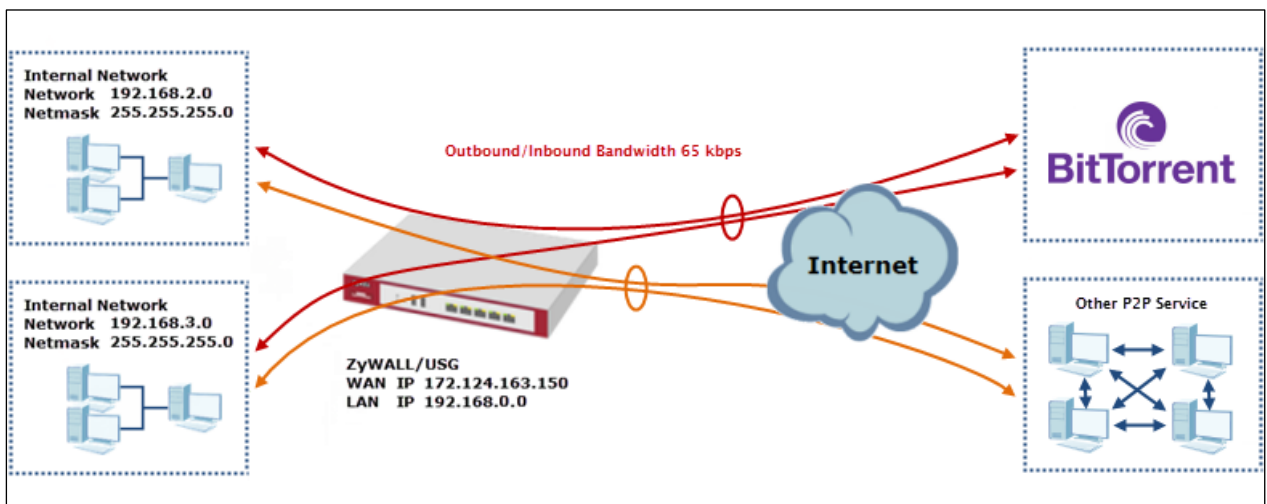

 Note: All network IP addresses and subnet masks are used as examples in this article. Please replace them with your actual network IP addresses and subnet masks. The total available bandwidth assumption is 1,600 kbps. This example was tested using USG310

## Set Up the Application Patrol Profile on the ZyWALL/USG

In the ZyWALL/USG, go to **CONFIGURATION > Object > Application > Add Application Rule**. Configure a **Name** for you to identify the **Application Profile**. Then, click **Add** to create an **Application Object**.

**CONFIGURATION > Object > Application > Add Application Rule**

Name:

Description:  (Optional)

#	Category	Application
No data to display		

Page 1 of 1 | Show 50 items

In the **Application Object**, select **By Service**, type a keyword and click **Search** to display all signatures containing that keyword. Select all **Query Result** and Click **OK**.

**CONFIGURATION > Object > Application > Add Application Rule > Add Application Object**

Query

Search:

Query Result

#	<input checked="" type="checkbox"/>	Category	Application
1	<input checked="" type="checkbox"/>	P2P	BitTorrent Series (transfer)
2	<input checked="" type="checkbox"/>	P2P	BitTorrent Series (access)
3	<input checked="" type="checkbox"/>	P2P	BitTorrent Series (connect)

Page 1 of 1 | Show 50 items | Displaying 1 - 3 of 3

## Set Up the Bandwidth Management for BitTorrent on the ZyWALL/USG

In the ZyWALL/USG, go to **CONFIGURATION > BWM > Configuration > Add Policy**, select **Enable** and type **BitTorrent Any-to-Any** as the policy's **Description**.

Leave the **Incoming Interface** to **any** and select the Outgoing Interface to be **wan1**. Select **Service Type** to be the **Service Object** and select **BitTorrent** from the list box.

Set the **Guaranteed Bandwidth Inbound** to 65 (kbps) and set **Priority 5** (low-to-medium). Set the **Maximum** to 512(kbps). Set the **Guaranteed Bandwidth Outbound** to 65 (kbps) and set **Priority 5**. Set the **Maximum** to 512 (kbps). Click **OK** to return to the **General** screen.

## CONFIGURATION > BWM > Configuration > Add Policy

### Configuration

Enable

Description: BitTorrent Any-to-Any (Optional)

BWM Type:  Shared  Per user  Per-Source-IP 

---

### Criteria

User: any

Schedule: none

Incoming Interface: any

Outgoing Interface: any

Source: any

Destination: any

DSCP Code: any

Service Type:  Service Object  Application Object

Application Object: BitTorrent

---

### DSCP Marking

DSCP Marking

Inbound Marking: preserve

Outbound Marking: preserve

---

### Bandwidth Shaping

Guaranteed Bandwidth	Inbound:	65	kbps (0 : disabled)	Priority:	5
	<input type="checkbox"/> Maximize Bandwidth Usage			Maximum:	512 kbps
Outbound:		65	kbps (0 : disabled)	Priority:	5
	<input type="checkbox"/> Maximize Bandwidth Usage			Maximum:	512 kbps

 Note: In Bandwidth Management, the highest priority is (1) the lowest priority is (7).



## Set Up the Bandwidth Management Global Setting on the ZyWALL/USG

In the ZyWALL/USG, go to **CONFIGURATION > BWM > BWM Global Setting**, select **Enable**.

**CONFIGURATION > BWM > BWM Global Setting**

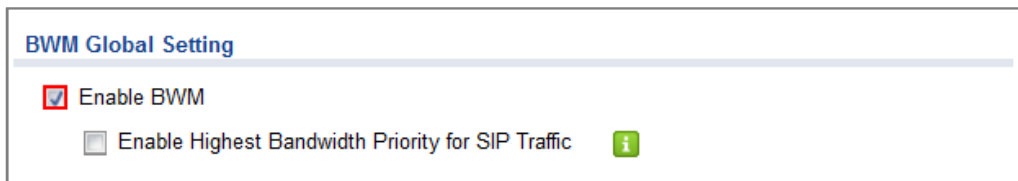

## Test the Result

Download BitTorrent application for testing the result:

<http://www.bittorrent.com/downloads>

In this example, an 826 MB file is downloading, the **Down Speed** limited to maximum 65 kB/s.

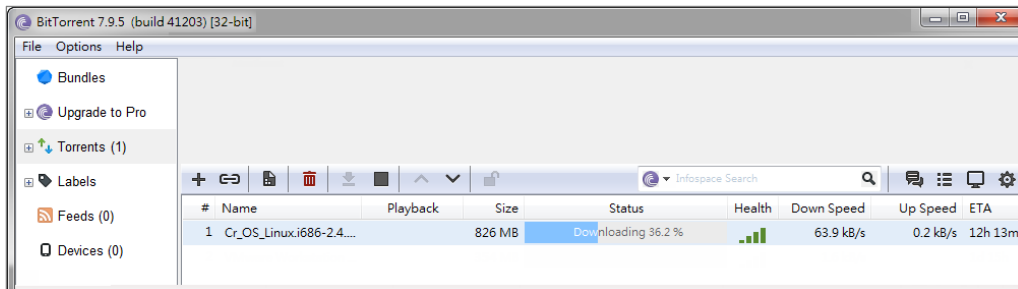

Go to the ZyWALL/USG **Monitor > Log**, you will see [alert] log message such as below.

**Monitor > Log**

Priority	Category	Message	Source	Destination	Protocol
alert	BWM	Mode=port-less Rule=1 matched	192.168.1.33:53722	187.34.56.190:13867	udp
alert	BWM	Mode=port-less Rule=1 matched	192.168.1.33:53722	84.250.209.195:51413	udp
alert	BWM	Mode=port-less Rule=1 matched	192.168.1.33:53722	89.43.62.55:51016	udp

## What Could Go Wrong?

If the "outbound" in the guaranteed bandwidth settings apply to traffic going from the connection initiator to the outgoing interface. "Inbound" refers to the reverse direction.

Make sure you have registered the **Application Patrol** service on the ZyWALL/USG to use **Application Object** as the **Service Type** in the bandwidth management rules.

Service Type:  Service Object  Application Object

Application Object: BitTorrent

You can click the link from the **CONFIGURATION > Licensing > Registration** screen of your ZyXEL device's Web Configurator or click the myZyXEL.com 2.0 icon from the portal page (<https://portal.myzyxel.com/>) to register or extend your **Application Patrol** license.

## How to Configure a Trunk for WAN Load Balancing with a Static or Dynamic IP Address

This is an example of using ZyWALL/USG Trunk for two WAN connections to the Internet. The available bandwidth for the connections is 1000 kbps (wan1 with static IP address) and 512 Kbps (wan2 with dynamic IP address) respectively. As these connections have different bandwidths, we will use the Weighted Round Robin (WRR) algorithm to send traffic to wan1 and wan2 in a 2:1 ratio.

ZyWALL/USG with WAN Load Balancing Example

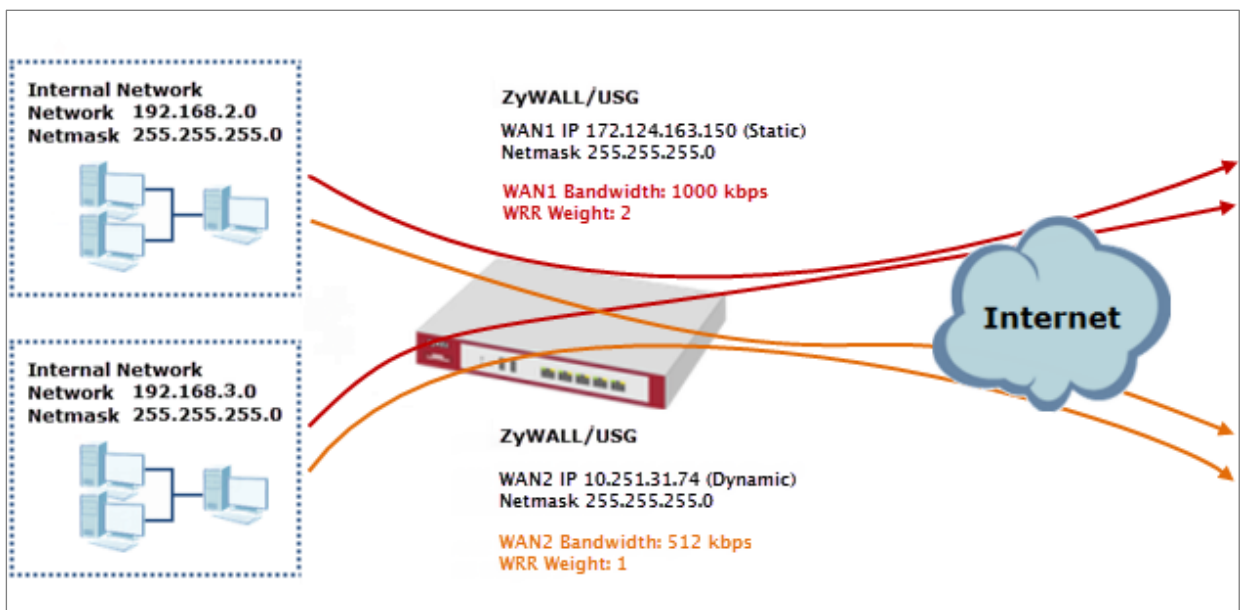

 Note: All network IP addresses and subnet masks are used as examples in this article. Please replace them with your actual network IP addresses and subnet masks. This example was tested using USG310 (Firmware Version: ZLD 4.25).

## Set Up the Available Bandwidth on WAN1 Interfaces on the ZyWALL/USG

In the ZyWALL/USG, go to **CONFIGURATION > Interface > Ethernet > WAN1 > Egress Bandwidth** and enter the available bandwidth (1000 kbps) in the **Egress Bandwidth** field. Click **OK**.

**CONFIGURATION > Interface > Ethernet > WAN1**

<b>General Settings</b>	
<input checked="" type="checkbox"/> Enable Interface	
<b>Interface Properties</b>	
Interface Type:	external <span>i</span>
Interface Name:	WAN1
Port:	P1
Zone:	WAN <span>i</span>
MAC Address:	B8:EC:A3:A9:C0:0B
Description:	<input type="text"/> (Optional)
<b>IP Address Assignment</b>	
<input type="radio"/> Get Automatically	
<input checked="" type="checkbox"/> Advance	
<input checked="" type="radio"/> Use Fixed IP Address	
IP Address:	172.124.163.150
Subnet Mask:	255.255.255.0
Gateway:	<input type="text"/> (Optional)
Metric:	0 (0-15)
<input checked="" type="checkbox"/> Enable IGMP Support	
<input checked="" type="radio"/> IGMP Upstream	
<input type="radio"/> IGMP Downstream	
<b>Interface Parameters</b>	
Egress Bandwidth:	1000 Kbps <span>i</span>

## Set Up the Available Bandwidth on WAN2 Interfaces on the ZyWALL/USG

In the ZyWALL/USG, go to **CONFIGURATION > Interface > Ethernet > WAN2 > Egress Bandwidth** and enter the available bandwidth (512 kbps) in the **Egress Bandwidth** field. Click **OK**.

**CONFIGURATION > Interface > Ethernet > WAN2**

The screenshot shows the configuration page for the WAN2 interface. The 'Egress Bandwidth' field is highlighted with a red box and contains the value '512'. Other fields include 'Interface Type' (external), 'Interface Name' (WAN2), 'Port' (P3), 'Zone' (WAN), 'MAC Address' (B8:EC:A3:A9:C0:0D), and 'IP Address Assignment' (Get Automatically, 10.251.31.74).

## Set Up the WAN Trunk on the ZyWALL/USG

In the ZyWALL/USG, go to **CONFIGURATION > Interface > Trunk > User Configuration > Add Trunk**. Configure a **Name** for you to identify the Trunk profile and set the **Load Balancing Algorithm** field to be the **Weighted Round Robin**.

Add **WAN1** and enter **2** in the **Weight** column. Add **WAN2** and enter **1** in the **Weight** column. Click **OK** to return to the **Configuration** screen.

**CONFIGURATION > Interface > Trunk > User Configuration > Add Trunk**

Name:

Load Balancing Algorithm:

#	Member	Mode	Weight
1	WAN1	Active	2
2	WAN2	Active	1

Page 1 of 1 Show 50 items Displaying 1 - 2 of 2

In the **Configuration** screen, go to **Default WAN Trunk** section, select **User Configured Trunk** and select the newly created Trunk from the list box. Click **Apply**.

**CONFIGURATION > Interface > Trunk > Default WAN Trunk**

**Default WAN Trunk**

Advance

Default Trunk Selection

SYSTEM\_DEFAULT\_WAN\_TRUNK

User Configured Trunk:

## Test the Result

Browse any website to test the result.

The Weighted Round Robin (WRR) algorithm is best suited for situations where the bandwidths set for the two WAN interfaces are different. An interface with a larger weight (**WAN1**) gets more chances to transmit traffic than an interface with a smaller weight (**WAN2**).

**MONITOR > Interface Summary > Interface Statistics**

Interface Statistics					
Refresh					
Name	Status	TxPkts	RxPkts	Tx B/s	Rx B/s
+ ge1	Down	0	0	0	0
+ WAN1	1000M/Full	16501	47815	0	634
+ WAN2	1000M/Full	268	169	0	0

## What Could Go Wrong?

If there is no traffic passing through either WAN1 or WAN2 interfaces, check that the **Mode** of both WAN1 & WAN2 should be **Active**. If a trunk is in **Passive** mode, the ZyWALL/USG will use this connection only when all of the connections set to **Active** mode are down.

## How to Configure DNS Inbound Load Balancing to balance DNS Queries Among Interfaces

This is an example of using the ZyWALL/USG dynamically responding to DNS query messages with its least loaded interface's IP address. The DNS query senders will then transmit packets to that interface instead of an interface that has a heavy load. This example assumes that your company's domain name is www.example.com. You want your ZyWALL/USG's WAN1 (202.1.2.3) and WAN2 (202.5.6.7) to use DNS inbound load balancing to balance traffic loading coming from the Internet.

ZyWALL/USG with DNS Inbound Load Balancing Example

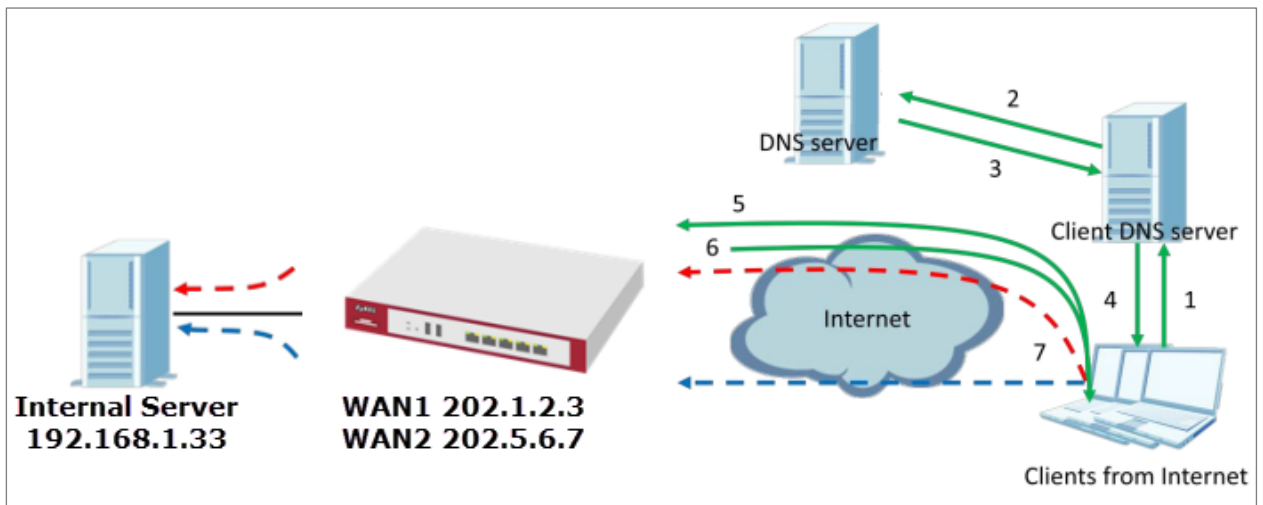

 Note: All network IP addresses and subnet masks are used as examples in this article. Please replace them with your actual network IP addresses and subnet masks. This example was tested using USG310 (Firmware Version: ZLD 4.25).



## Set Up the DNS Inbound Load Balancing on the ZyWALL/USG

In the ZyWALL/USG, go to **CONFIGURATION > Network > DNS Inbound LB**. Edit the **Query Domain Name**, set the **Load Balancing Algorithm** field to be the **Least Load - Total**. Click **Add** to create a new **Load Balancing Member**.

**CONFIGURATION > Network > DNS Inbound LB**

**General Setting**

Enable

**DNS Settings**

Query Domain Name:

Time to Live:  (0-604800 seconds, 0 is unchanged)

**Query From Settings**

IP Address:

Zone:

**Load Balancing Member**

Load Balancing Algorithm:

Failover IP Address:  (Optional)

#	IP Address	Monitor Interface
No data to display		

If you want to configure Security Option Control, please go to [DNS](#)

**CONFIGURATION > Network > DNS Inbound LB**

The screenshot shows a dialog box titled "Add Load Balancing Member" with a sub-header "Load Balancing Member". It contains the following fields and options:

- Member: 1
- Monitor Interface: WAN1 (highlighted with a red box) | DHCP client -- 202.1.2.3/255.255.255.0
- IP Address:
  - Same as Monitor Interface: 202.1.2.3
  - Custom: 0.0.0.0

At the bottom right, there are "OK" and "Cancel" buttons, with "OK" highlighted by a red box.

## CONFIGURATION > Network > DNS Inbound LB

The screenshot shows a dialog box titled "Add Load Balancing Member" with a sub-header "Load Balancing Member". It contains the following fields and options:

- Member: 2
- Monitor Interface: WAN2 (highlighted with a red box) | DHCP client -- 202.5.6.7/255.255.255.0
- IP Address:
  - Same as Monitor Interface: 202.5.6.7
  - Custom: 0.0.0.0

At the bottom right, there are "OK" and "Cancel" buttons, with "OK" highlighted by a red box.

Go to **the Global Setting page** to select **Enable DNS Load Balancing**.

## CONFIGURATION > Network > DNS Inbound LB

The screenshot shows a "Global Setting" section with a single checkbox labeled "Enable DNS Load Balancing". The checkbox is checked and highlighted with a red box.

## Set Up the NAT Rule on the ZyWALL/USG

In the ZyWALL/USG, go to **CONFIGURATION > Network > NAT**. Configure the **Virtual**

**Server** to forward the traffic from WAN to Internal Server (192.168.1.33). Click **OK**.

**CONFIGURATION > Network > NAT**

General Settings	
<input checked="" type="checkbox"/> Enable Rule	
Rule Name:	NAT_WAN1
Port Mapping Type	
Classification:	<input checked="" type="radio"/> Virtual Server <input type="radio"/> 1:1 NAT <input type="radio"/> Many 1:1 NAT
Mapping Rule	
Incoming Interface:	WAN1
Original IP:	User Defined
User-Defined Original IP:	202.1.2.3 (IP Address)
Mapped IP:	User Defined
User-Defined Mapped IP:	192.168.1.33 (IP Address)
Port Mapping Type:	Port
Protocol Type:	any
Original Port:	80
Mapped Port:	80

General Settings	
<input checked="" type="checkbox"/> Enable Rule	
Rule Name:	NAT_WAN2
Port Mapping Type	
Classification:	<input checked="" type="radio"/> Virtual Server <input type="radio"/> 1:1 NAT <input type="radio"/> Many 1:1 NAT
Mapping Rule	
Incoming Interface:	WAN2
Original IP:	User Defined
User-Defined Original IP:	202.5.6.7 (IP Address)
Mapped IP:	User Defined
User-Defined Mapped IP:	192.168.1.33 (IP Address)
Port Mapping Type:	Port
Protocol Type:	any
Original Port:	80
Mapped Port:	80

## Test the Result

Open the browser and query <http://zyxel.for-our.info/>.

Create a **Security Policy** in order to view the testing result. Set **Destination** to be the Internal Server IP address (192.168.1.33 in this example) and set **Log** type to be the **Log Alert**.

Go to the ZyWALL/USG **Monitor > Log**, you will see [alert] log message such as below. The **Source Interface** is the WAN1 or WAN2 interface which is handling the least amount of outgoing and incoming traffic.

Prior...	Category	Message	Source	Source I...	Destination	Note
alert	Security Policy ...	priority:1, from ANY to ANY, TCP, service oth...	202.1.2.4:52268	WAN2	192.168.1.33:80	ACCESS FORWA...
alert	Security Policy ...	priority:1, from ANY to ANY, TCP, service oth...	202.1.2.4:52267	WAN2	192.168.1.33:80	ACCESS FORWA...
alert	Security Policy ...	priority:1, from ANY to ANY, TCP, service oth...	202.1.2.4:52266	WAN1	192.168.1.33:80	ACCESS FORWA...
alert	Security Policy ...	priority:1, from ANY to ANY, TCP, service oth...	202.1.2.4:52265	WAN1	192.168.1.33:80	ACCESS FORWA...
alert	Security Policy ...	priority:1, from ANY to ANY, TCP, service oth...	202.1.2.4:52260	WAN1	192.168.1.33:80	ACCESS FORWA...
alert	Security Policy ...	priority:1, from ANY to ANY, TCP, service oth...	202.1.2.4:52259	WAN1	192.168.1.33:80	ACCESS FORWA...
alert	Security Policy ...	priority:1, from ANY to ANY, TCP, service oth...	202.1.2.4:52258	WAN2	192.168.1.33:80	ACCESS FORWA...
alert	Security Policy ...	priority:1, from ANY to ANY, TCP, service oth...	202.1.2.4:52257	WAN2	192.168.1.33:80	ACCESS FORWA...

## What Could Go Wrong?

If you cannot access the Internal Server, please check that the NAT configuration matches the Internal Server IP address and Port number. If the NAT configuration is correct, please check the system status of your Internal Server is up.

## How to Manage Voice Traffic

This is an example of using Application Layer Gateway (ALG) to allow the SIP (Session Initiation Protocol) voice traffic through the ZyWALL/USG. To achieve high-quality voice transmissions, use ZyWALL/USG provides Bandwidth Management (BWM) function to effectively manage bandwidth according to flexible criteria. You can limit bandwidth consuming services, such as Peer-to-Peer (P2P) and FTP service while providing a higher priority and consistent bandwidth for voice traffic.

ZyWALL/USG with Voice Traffic Management Example

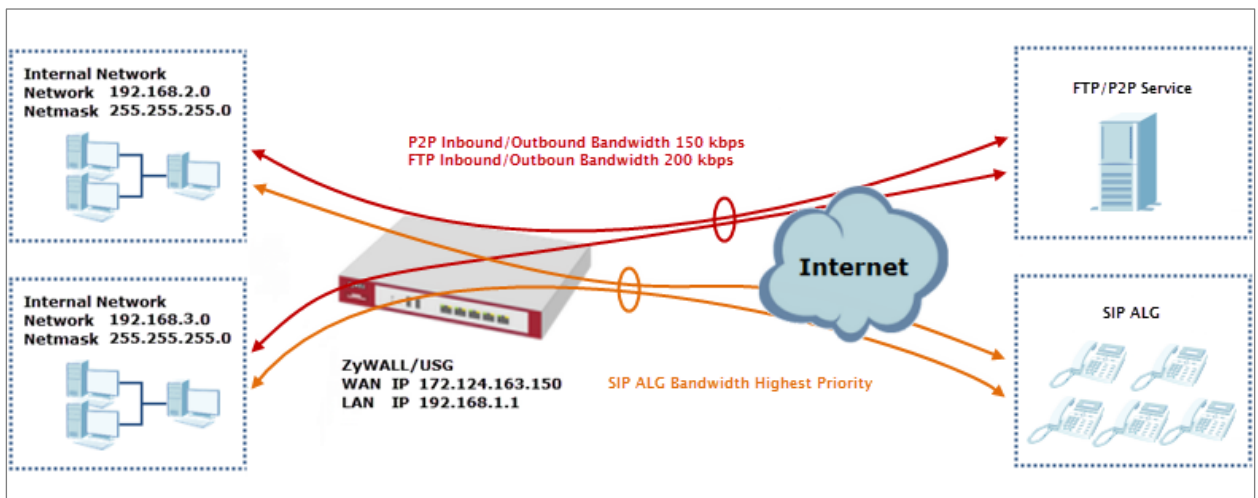

 Note: All network IP addresses and subnet masks are used as examples in this article. Please replace them with your actual network IP addresses and subnet masks. This example was tested using USG310 (Firmware Version: ZLD 4.25).

## Set Up the SIP ALG on the ZyWALL/USG

In the ZyWALL/USG, go to **CONFIGURATION > Network > SIP > SIP Settings**, select **Enable SIP ALG**, **Enable SIP Transformations** (optional), **Restrict Peer to Peer Signaling Connection** and **Restrict Peer to Peer Media Connection**. Make sure the **SIP Signaling Port** is configured the same as your VoIP phone SIP signaling port. Click **Apply**.

**CONFIGURATION > BWM > Configuration > Add Policy**

**SIP Settings**

Enable SIP ALG

Enable SIP Transformations

Enable Configure SIP Inactivity Timeout

SIP Media Inactivity Timeout :  (seconds)

SIP Signaling Inactivity Timeout :  (seconds)

Restrict Peer to Peer Signaling Connection

Restrict Peer to Peer Media Connection i

SIP Signaling Port :

#	Port
1	5060

 **Note:** If you are using a custom or additional UDP port number (not 5060) for SIP traffic, use the **Add** icon to add **SIP Signaling Port** numbers.

## Set Up the Bandwidth Management for SIP on the ZyWALL/USG

In the ZyWALL/USG, go to **CONFIGURATION > BWM > BWM Global Settings**, select

Enable **BWM** and **Enable Highest Bandwidth Priority for SIP Traffic**.

**CONFIGURATION > BWM > BWM Global Settings > Enable BWM**

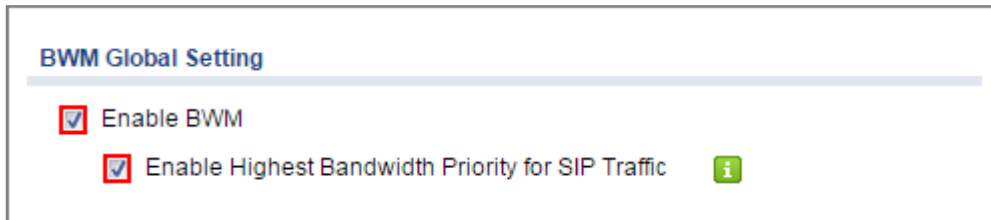

**BWM Global Setting**

Enable BWM

Enable Highest Bandwidth Priority for SIP Traffic 

## Set Up the Bandwidth Management for P2P on the ZyWALL/USG

In the ZyWALL/USG, go to **CONFIGURATION > BWM > Configuration > Add Policy**, select **Enable** and type **P2P Any-to-WAN** as the policy's **Description**.

Leave the **Incoming Interface** to **any** and select the Outgoing Interface to be **WAN1**. Select **Service Type** to be the **Application Object** and select **P2P** from the list box.

Set the **Guaranteed Bandwidth Inbound** to 100 (kbps) and set **Priority** 5. Set the **Maximum** to 150 (kbps). Set the **Guaranteed Bandwidth Outbound** to 100 (kbps) and set **Priority** 5. Set the **Maximum** to 150 (kbps). Click **OK** to return to the **General** screen.

## CONFIGURATION > BWM > Configuration > Add Policy

**Configuration**

Enable

Description: P2P Any-to-WAN (Optional)

BWM Type:  Shared  Per user  Per-Source-IP i

---

**Criteria**

User: any

Schedule: none

Incoming Interface: any

Outgoing Interface: WAN1

Source: any

Destination: any

DSCP Code: any

Service Type:  Service Object  Application Object

Application Object: P2P

---

**DSCP Marking**

DSCP Marking

Inbound Marking: preserve

Outbound Marking: preserve

---

**Bandwidth Shaping**

Guaranteed Bandwidth

Inbound: 100 kbps (0 : disabled) Priority: 5

Maximize Bandwidth Usage Maximum: 150 kbps

Outbound: 100 kbps (0 : disabled) Priority: 5

Maximize Bandwidth Usage Maximum: 150 kbps

 Note: In Bandwidth Shaping, the highest priority is (1) the lowest priority is (7).

## Set Up the Bandwidth Management for FTP on the ZyWALL/USG

In the ZyWALL/USG, go to **CONFIGURATION > BWM > Configuration > Add Policy**, select **Enable** and type **FTP Any-to-Any** as the policy's **Description**.



Leave the **Incoming Interface** to **any** and select the Outgoing Interface to be **WAN1**. Select **Service Type** to be the **Service Object** and select **FTP** from the list box.

Set the **Guaranteed Bandwidth Inbound** to 150 (kbps) and set **Priority** 5. Set the **Maximum** to 200 (kbps). Set the **Guaranteed Bandwidth Outbound** to 150 (kbps) and set **Priority** 5. Set the **Maximum** to 200 (kbps). Click **OK** to return to the **General** screen.

## CONFIGURATION > BWM > Configuration > Add Policy

**Configuration**

Enable

Description: FTP Any-to-WAN (Optional)

BWM Type:  Shared  Per user  Per-Source-IP i

---

**Criteria**

User: any

Schedule: none

Incoming Interface: any

Outgoing Interface: WAN1

Source: any

Destination: any

DSCP Code: any

Service Type:  Service Object  Application Object

Service Object: FTP

---

**DSCP Marking**

DSCP Marking

Inbound Marking: preserve

Outbound Marking: preserve

---

**Bandwidth Shaping**

Guaranteed Bandwidth

	Inbound: <span style="border: 1px solid red; padding: 2px;">150</span> kbps (0 : disabled)	Priority: <span style="border: 1px solid red; padding: 2px;">5</span>
	<input type="checkbox"/> Maximize Bandwidth Usage	Maximum: <span style="border: 1px solid red; padding: 2px;">200</span> kbps
	Outbound: <span style="border: 1px solid red; padding: 2px;">150</span> kbps (0 : disabled)	Priority: <span style="border: 1px solid red; padding: 2px;">5</span>
	<input type="checkbox"/> Maximize Bandwidth Usage	Maximum: <span style="border: 1px solid red; padding: 2px;">200</span> kbps

Note: In Bandwidth Shaping, the highest priority is (1) the lowest priority is (7).

## Test the Result

Add a **Security Policy** rule to view the SIP log:

### CONFIGURATION > BWM > Configuration > Add Policy







Dial Phone Number 1001 (192.168.10.2 in this example) from Phone Number 1002 (192.168.100.2 in this example), go to the ZyWALL/USG **Monitor > Log**, you will see [alert] log message such as below. The **Destination** IP address is the SIP Server IP address.

### Monitor > Log

Priority	Category	Message	Source	Destination	Note
alert	Security Policy Control	priority:1, from ANY to ANY, UDP, service SIP, ACCEPT	192.168.100.2:5060	172.124.163.150:5060	ACCESS FORWARD

Go to the ZyWALL/USG **Monitor > Traffic Statics** and review the SIP traffic and other services to optimize the **Guaranteed** and **Maximum BMW** of bandwidth consuming services.

### Monitor > Traffic Statics

#	Service Port	Protocol	Direction	Amount
1	sip(Port : 5060)	UDP	Ingress	 10.137(MBytes)
2	sip(Port : 5060)	UDP	Egress	 10.138(MBytes)
3	ftp(Port : 21)	TCP	Ingress	 863(Bytes)
4	ftp(Port : 21)	TCP	Egress	 807(Bytes)
5	https(Port : 443)	TCP	Ingress	 29.716(KBytes)
6	www(Port : 80)	TCP	Egress	 1.196(KBytes)

## What Could Go Wrong?

If you see [alert] log message such as below, the voice traffic is blocked by the priority 1 **Security Policy**. The ZyWALL/USG checks the security policy in order and applies the first security policy the traffic matches. If the voice traffic matches a policy that comes earlier in the list, it may be unexpectedly blocked. Please change your policy setting or move the voice traffic policy to the higher priority.

### Monitor > Log

Priority	Category	Message	Source	Destination	Note
alert	Security Policy Control	priority:1, from ANY to ANY, UDP, service others, DROP	192.168.100.2:5060	172.124.163.150:5060	ACCESS BLOCK
alert	Security Policy Control	priority:1, from ANY to ANY, UDP, service others, DROP	192.168.100.2:5060	172.124.163.150:5060	ACCESS BLOCK

## How to Manage ZyWALL/USG Configuration Files

This is an example of how to rename, download, copy, apply and upload configuration files. Once your ZyWALL/USG is configured and functioning properly, it is highly recommended that you back up your configuration file before making further configuration changes. The backup configuration file will be useful in case you need to return to your previous settings.

The **system-default.conf** file contains the ZyWALL/USG's default settings. This configuration file is included when you upload a firmware package.

The **startup-config.conf** file is the configuration file that the ZyWALL/USG is currently using. If you make and save changes during your management session, the changes are applied to this configuration file.

The **lastgood.conf** is the most recently used (valid) configuration file that was saved when the device last restarted.

ZyWALL/USG with Configuration Files Example

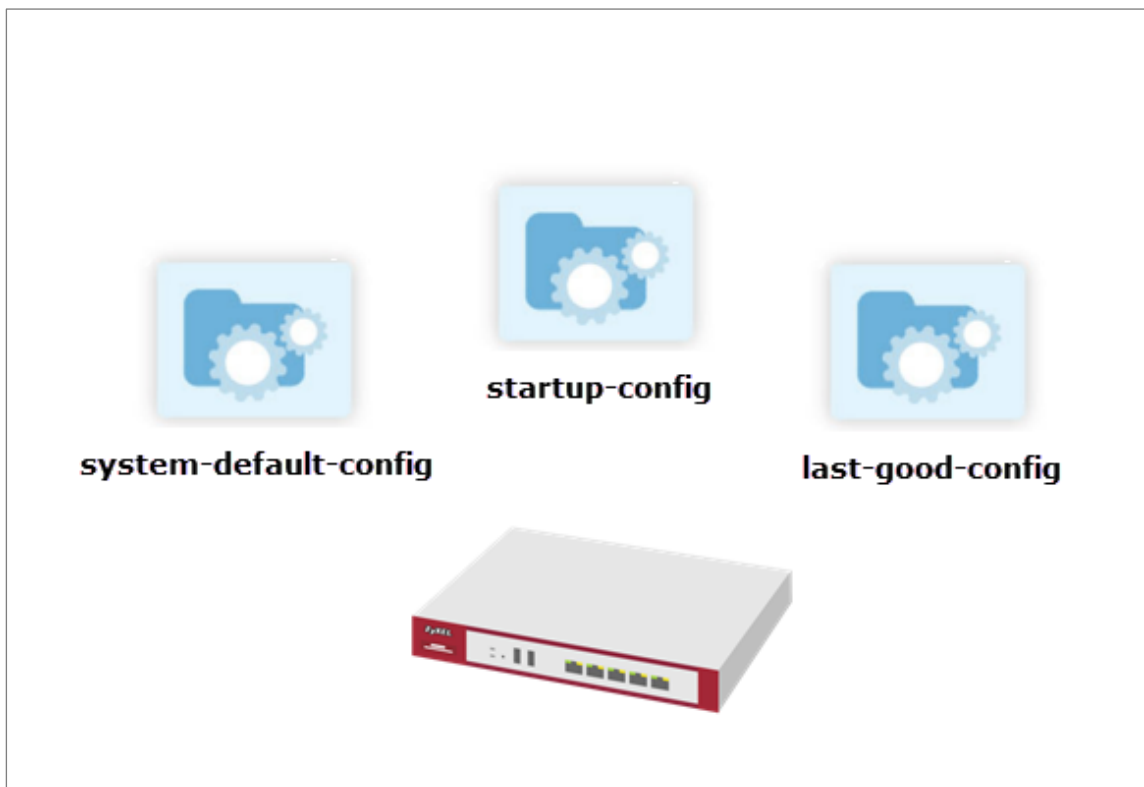

 Note: This example was using USG310 (Firmware Version: ZLD 4.25).

## Rename the Configuration Files from the ZyWALL/USG

In the ZyWALL/USG, go to **MAINTENANCE > File Manager > Configuration File**, select the configuration file and click **Rename**. A pop-up screen will appear allowing you to edit the **Target file** name. Click **OK** to save the **Rename** configuration.

### MAINTENANCE > File Manager > Configuration File

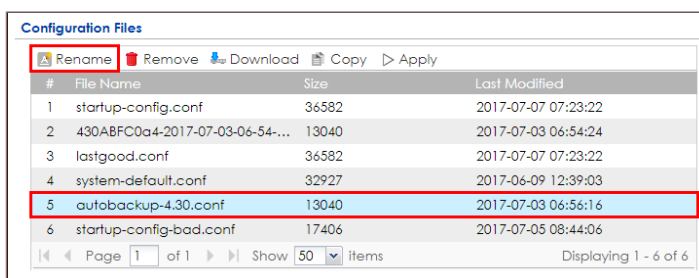

#	File Name	Size	Last Modified
1	startup-config.conf	36582	2017-07-07 07:23:22
2	430ABFC0a4-2017-07-03-06-54-...	13040	2017-07-03 06:54:24
3	lastgood.conf	36582	2017-07-07 07:23:22
4	system-default.conf	32927	2017-06-09 12:39:03
5	autobackup-4.30.conf	13040	2017-07-03 06:56:16
6	startup-config-bad.conf	17406	2017-07-05 08:44:06

### MAINTENANCE > File Manager > Configuration File > Rename

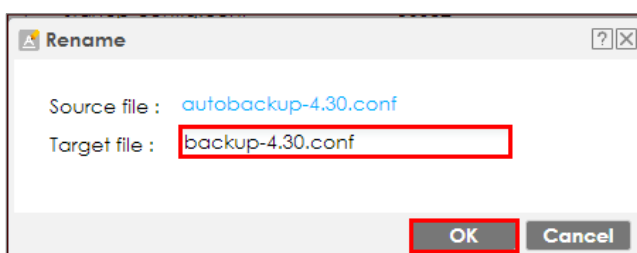

**Rename**

Source file : [autobackup-4.30.conf](#)

Target file :

## Download the Configuration Files on the ZyWALL/USG

In the ZyWALL/USG, go to **MAINTENANCE > File Manager > Configuration File**, select the configuration file and click **Download** to back up your configuration file from ZyWALL/USG to your computer.

## MAINTENANCE > File Manager > Configuration File

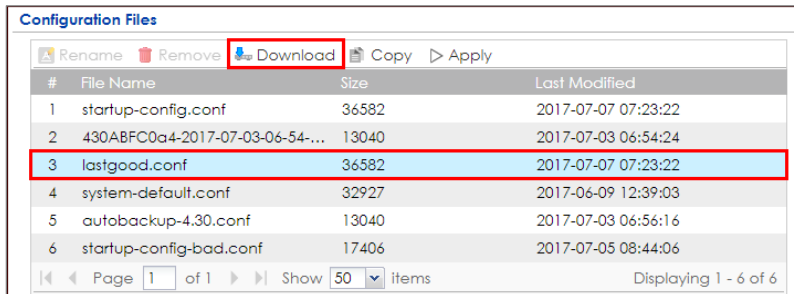

Configuration Files

Rename Remove Download Copy Apply

#	File Name	Size	Last Modified
1	startup-config.conf	36582	2017-07-07 07:23:22
2	430ABFC0a4-2017-07-03-06-54-...	13040	2017-07-03 06:54:24
3	lastgood.conf	36582	2017-07-07 07:23:22
4	system-default.conf	32927	2017-06-09 12:39:03
5	autobackup-4.30.conf	13040	2017-07-03 06:56:16
6	startup-config-bad.conf	17406	2017-07-05 08:44:06

Page 1 of 1 Show 50 items Displaying 1 - 6 of 6

## Copy the Configuration Files on the ZyWALL/USG

In the ZyWALL/USG, go to **MAINTENANCE > File Manager > Configuration File**, select the configuration file and click **Copy**. A pop-up screen will appear allowing you to edit the **Target file** name. Click **OK** to save the **Copy** configuration.

## MAINTENANCE > File Manager > Configuration File

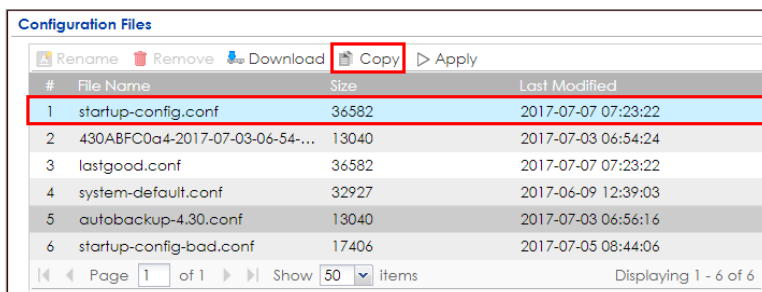

Configuration Files

Rename Remove Download Copy Apply

#	File Name	Size	Last Modified
1	startup-config.conf	36582	2017-07-07 07:23:22
2	430ABFC0a4-2017-07-03-06-54-...	13040	2017-07-03 06:54:24
3	lastgood.conf	36582	2017-07-07 07:23:22
4	system-default.conf	32927	2017-06-09 12:39:03
5	autobackup-4.30.conf	13040	2017-07-03 06:56:16
6	startup-config-bad.conf	17406	2017-07-05 08:44:06

Page 1 of 1 Show 50 items Displaying 1 - 6 of 6

## MAINTENANCE > File Manager > Configuration File > Copy



Copy File

Source file : startup-config.conf

Target file : startup-config(1).conf

OK Cancel

## Apply the Configuration Files on the ZyWALL/USG

In the ZyWALL/USG, go to **MAINTENANCE > File Manager > Configuration File**, select a specific configuration file to have ZyWALL/USG use it. For example, select the **system-default.conf** file and click **Apply** to reset all of the ZyWALL/USG settings to the factory defaults. Or select the **lastgood.conf** which is the most recently used (valid) configuration file that was saved when the device last restarted. If you uploaded and applied a configuration file with an error, select this file then click **Apply** to return to a valid configuration.

### MAINTENANCE > File Manager > Configuration File

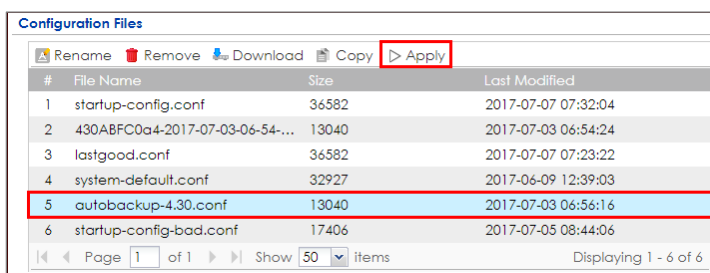

#	File Name	Size	Last Modified
1	startup-config.conf	36582	2017-07-07 07:32:04
2	430ABFC0a4-2017-07-03-06-54-...	13040	2017-07-03 06:54:24
3	lastgood.conf	36582	2017-07-07 07:23:22
4	system-default.conf	32927	2017-06-09 12:39:03
5	autobackup-4.30.conf	13040	2017-07-03 06:56:16
6	startup-config-bad.conf	17406	2017-07-05 08:44:06

A pop-up screen will appear allowing you to edit the **Target file** name. Select **Immediately stop applying the configuration file and roll back to the previous configuration** to get the ZyWALL/USG started with a fully valid configuration file as quickly as possible. Click **OK** to have the ZyWALL/USG start applying the configuration file.

### MAINTENANCE > File Manager > Configuration File > Apply Configuration File

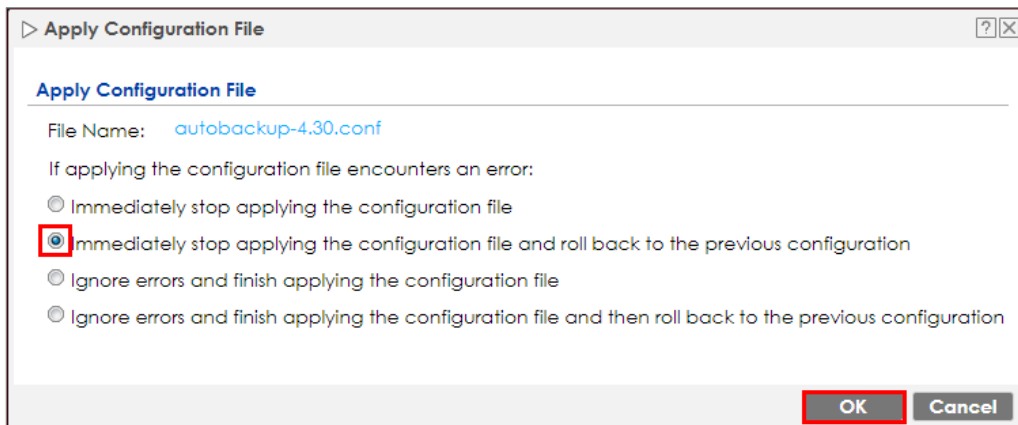

 Note: Do not shut down the ZyWALL/USG while the configuration file is being applied.

## Upload the Configuration Files from the ZyWALL/USG

In the ZyWALL/USG, go to **MAINTENANCE > File Manager > Configuration File > Upload Configuration File**, select **Browse** to upload a new or previously saved configuration file from your computer to your ZyWALL/USG. You cannot upload a configuration file named **system-default.conf** or **lastgood.conf**. If you upload **startup-config.conf**, it will replace the current configuration and immediately apply the new settings.

### MAINTENANCE > File Manager > Configuration File

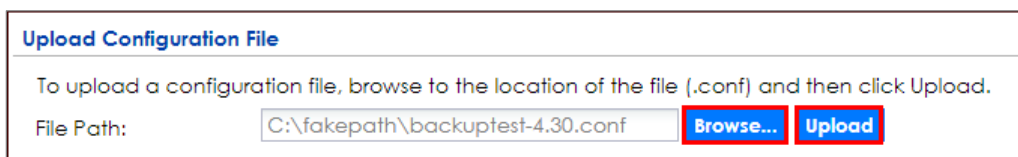

## What Could Go Wrong?

If you cannot apply a configuration file and the device shows error message, go to **Monitor > Log** to check the [alert] log message and make the correction of the



configuration file. In this example, the [alert] log message shows the configuration file has an incomplete static DHCP address so that the device can't apply it.

**MAINTENANCE > File Manager > Configuration File > Apply Configuration File**

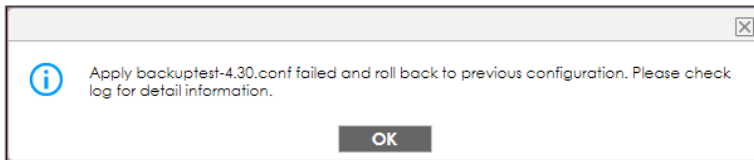

**Monitor > Log**

Priority	Category	Message	Note
alert	File Manager	Going to rollback previous running-config.	Apply Config
alert	File Manager	ERROR: #configure terminal interface _ether dmz ip address 192.168.3.1 255....	Apply Config

## How to Manage ZyWALL/USG Firmware

This is an example of using ZyWALL/USG to check your current firmware version and upload firmware to the ZyWALL/USG. You can upload firmware to be the **Running** firmware or **Standby** firmware.

ZyWALL/USG with Firmware Management Example

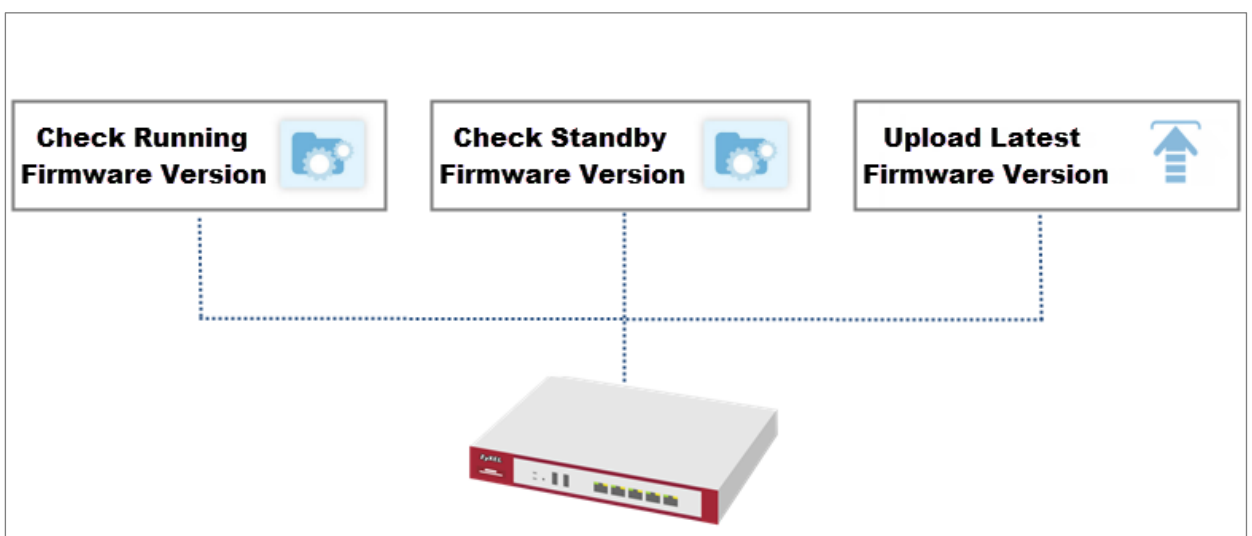

 Note: The firmware update can take up to five minutes. Do not turn off or reset the ZyWALL/USG while the firmware update is in progress. This example was using USG110 (Firmware Version: ZLD 4.25).

## Download the Current Firmware Version from ZyXEL.com

Go to [www.zyxel.com/support/download\\_landing.shtml](http://www.zyxel.com/support/download_landing.shtml) and download the current firmware package.

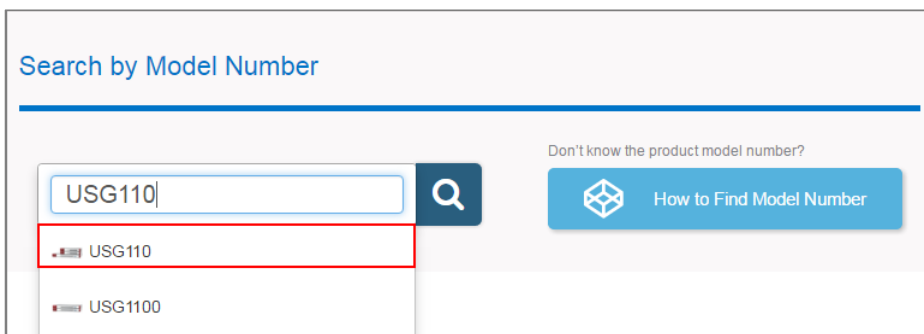

The screenshot shows a search interface titled "Search by Model Number". It features a search input field containing "USG110" and a search button. Below the input field, a dropdown menu is open, showing two results: "USG110" (highlighted with a red box) and "USG1100". To the right of the search field, there is a link "Don't know the product model number?" and a button "How to Find Model Number".

Material	Version	Checksum	Release Date	Release Note	Download
Firmware	4.15(AAPH.0)C0		Mar 25, 2016		
3G Dongle Document	3		Mar 26, 2015		

Extract firmware zip file.



USG110\_4.15(AAPH.0)C0.zip

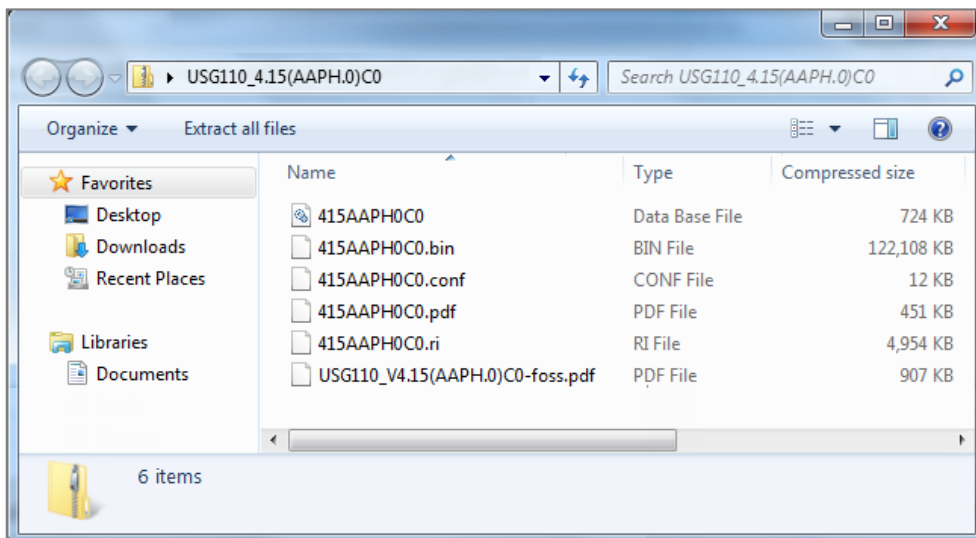

## Upload the Firmware on the ZyWALL/USG

In the ZyWALL/USG, go to **MAINTENANCE > File Manager > Firmware Package > Upload File**. Click the **To upload image file in system space** pull-down menu and select **(1)** or **(2)**. The default **Standby** system space is **(2)**, so if you want to upload new firmware to be the **Running** firmware, then select the **Running** system space

(1). The ZyWALL/USG will reboot automatically.

If you upload firmware to the **Standby** system space (2), you have the option to select **Reboot now** or **Don't Reboot**.

**MAINTENANCE > File Manager > Firmware Package > Upload File > (1)**

**Firmware Status**

Reboot now

#	Status	Model	Version	Released Date
1	Running	USG110	V4.13(AAPH.1)ITS-WK41-r64509	2015-10-13 23:09:45
2	Standby	USG110	V4.11(AAPH.2)	2015-04-20 20:41:35

Page 1 of 1 | Show 50 items | Displaying 1 - 2 of 2

---

**Upload File**

To upload image file in system space: 1

Boot Options

Reboot now

Don't Reboot

To upload firmware, browse to the location of the file (\*.bin) and then click Upload.

File Path:

**MAINTENANCE > File Manager > Firmware Package > Upload File > (2)**

**Firmware Status**

Reboot now

#	Status	Model	Version	Released Date
1	Running	USG110	V4.13(AAPH.1)ITS-WK41-r64509	2015-10-13 23:09:45
2	Standby	USG110	V4.11(AAPH.2)	2015-04-20 20:41:35

Page 1 of 1 | Show 50 items | Displaying 1 - 2 of 2

---

**Upload File**

To upload image file in system space: 2

Boot Options

Reboot now

Don't Reboot

To upload firmware, browse to the location of the file (\*.bin) and then click Upload.

File Path:

To upload firmware, click **Browse** to the location of the file (\*.bin) and then click **Upload**.

**Upload File**

To upload image file in system space:

Boot Options

Reboot now  
 Don't Reboot

To upload firmware, browse to the location of the file (\*.bin) and then click Upload.

File Path:

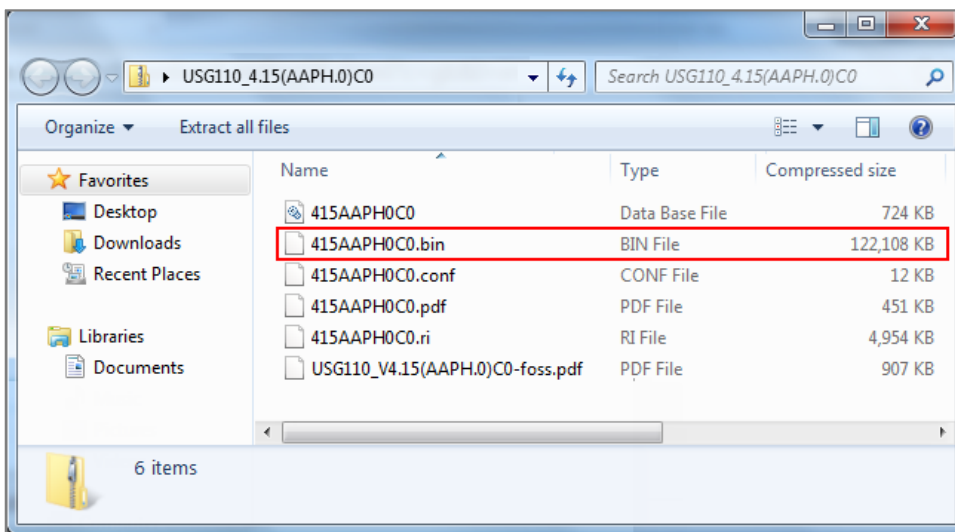

**Upload File**

To upload image file in system space:

Boot Options

Reboot now  
 Don't Reboot

To upload firmware, browse to the location of the file (\*.bin) and then click Upload.

File Path:

 Note: The default **Running** system space is (1), the **Standby** system space is (2). If you select the **Standby** firmware and click **Reboot now** or you upload file to **Standby** system space (2) and select **Boot Options** to be **Reboot now**. After reboot process complete, the **Running** system space will be (2). **Standby** system space will be (1).

## What Could Go Wrong?

If you cannot download the firmware, please check if you enable the **Destroy compressed files that could not be decompressed** function in **Anti-Virus**.

ZyWALL/USG firmware package is ZIP file, the ZyWALL/USG classifies the firmware package as not being able to decompress will delete it. Please disable this option while downloading the firmware package.

## How to Get Started Using the Wizards

When you log into the Web Configurator for the first time or when you reset the ZyWALL/USG to its default configuration, the **Installation Setup Wizard** screen displays. This is an example of using ZyWALL/USG Wizards to configure Internet connection settings, wireless settings and device registration services.

ZyWALL/USG with Installation Setup Wizard Example

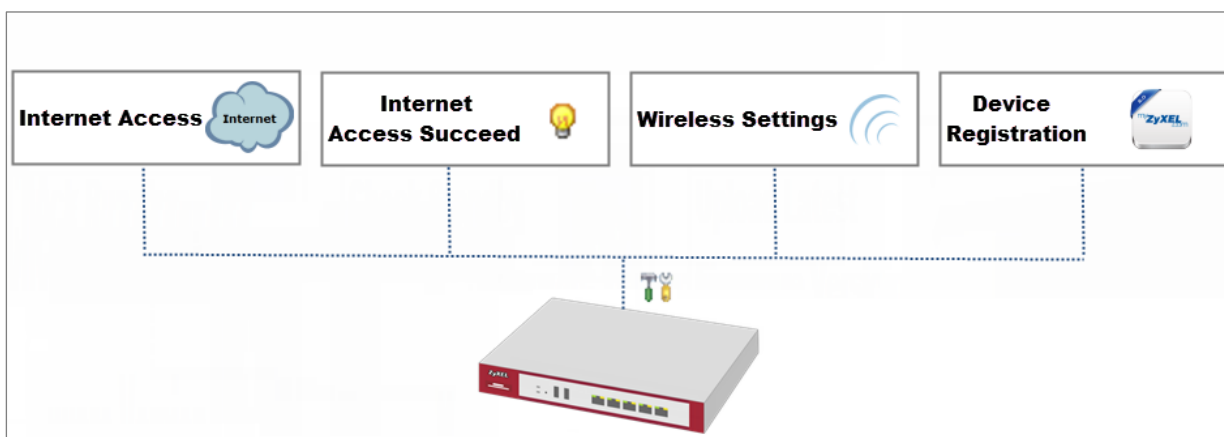

 Note: You need internet access to activate your ZyWALL/USG subscription services. This example was tested using USG310 (Firmware Version: ZLD 4.25).

## Set Up the Internet Access (Ethernet) Wizard on the

### ZyWALL/USG

In the ZyWALL/USG **Installation Setup Wizard** Welcome page, click **Next** to start configuring. Click the double arrow in the upper right corner to display <<

) or hide (>>) the help.

## Installation Setup Wizard > Welcome

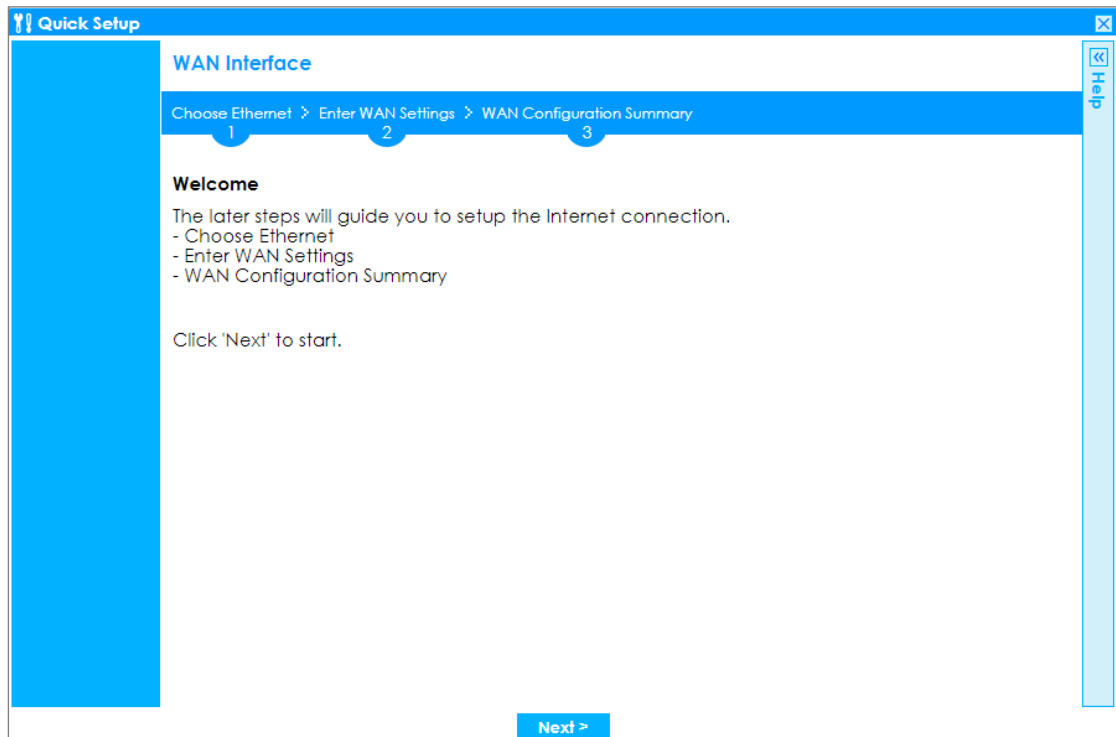

In the **Internet Access** page, you can configure Internet connections from two



Internet service providers (ISPs). Connect your ISP devices to your ZyWALL/USG WAN port, select **I have two ISPs** if you want to configure two Internet connections or leave it cleared to configure just one.

Choose the **Encapsulation** option to be **Ethernet**, leave **Zone** as default setting Internet connection belongs to the WAN zone.

In the **IP Address Assignment** section, select **Auto** if your ISP did not assign you a fixed IP address or select **Static** if your ISP did assign you a fixed IP address. Click **Next**.

## Installation Setup Wizard > Welcome > Internet Access

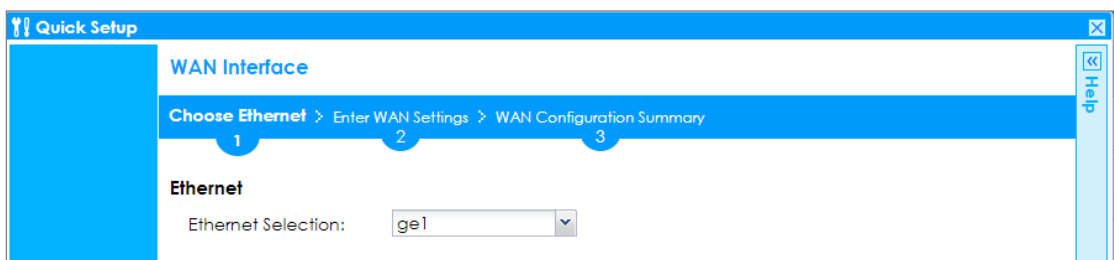

The screenshot shows the 'Quick Setup' window for the 'WAN Interface' section. A progress bar at the top indicates three steps: 'Choose Ethernet' (1), 'Enter WAN Settings' (2), and 'WAN Configuration Summary' (3). The 'Ethernet' section is active, showing 'Ethernet Selection:' with a dropdown menu set to 'ge1'.

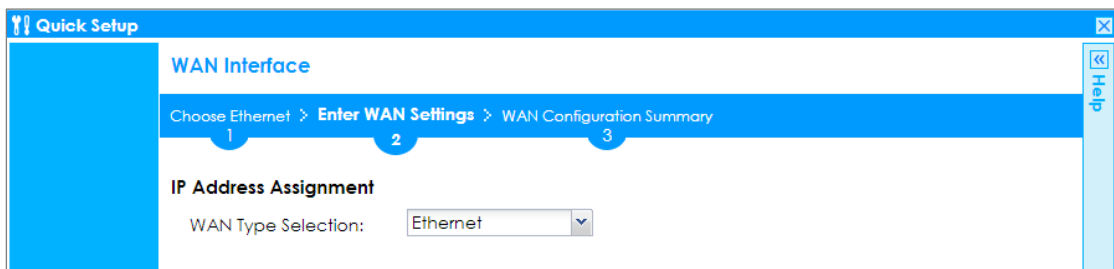

The screenshot shows the 'Quick Setup' window for the 'WAN Interface' section. The progress bar is the same. The 'IP Address Assignment' section is active, showing 'WAN Type Selection:' with a dropdown menu set to 'Ethernet'.



The screenshot shows the 'Quick Setup' window for the 'WAN Interface' section. The progress bar is the same. The 'Interface' section is active, showing 'WAN Interface:' set to 'ge1', 'Zone:' set to 'WAN', and 'IP Address Assignment:' set to 'Static' (highlighted with a red box).

Enter the **IP Address**, **IP Subnet Mask** and **Gateway IP Address** exactly as given by

your ISP or network administrator. First/Second DNS Servers are optional. Click **Next**.

**Installation Setup Wizard > Welcome > Internet Access**

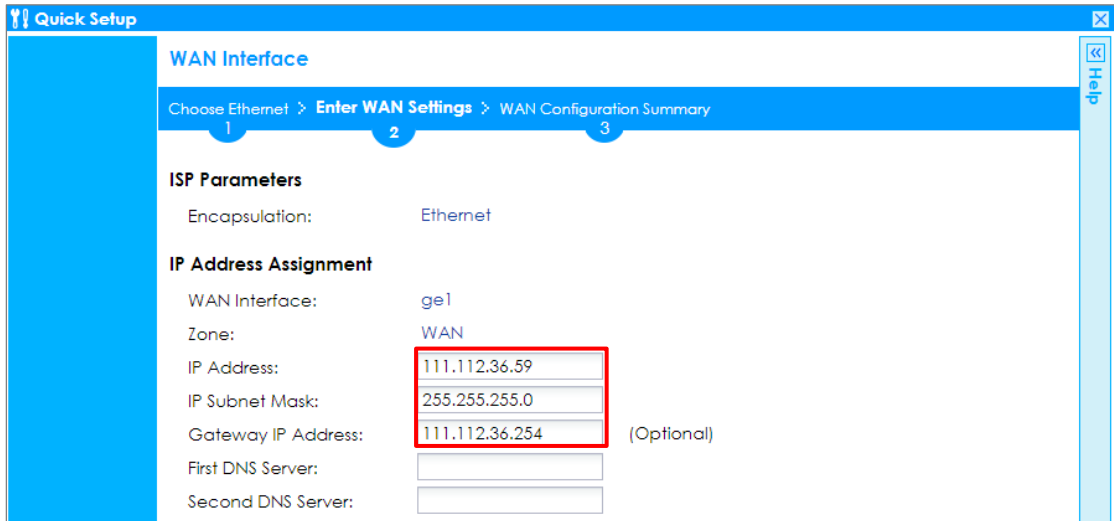

The **Internet Access Succeed** page will display the summary of Internet access of the **First Setting**. If you select **I have two ISPs** in **Internet Access > ISP Setting**, click **Next** to configure the second WAN interface or continue to the **Wireless Settings** page.

**Installation Setup Wizard > Welcome > Internet Access > Internet Access Succeed**

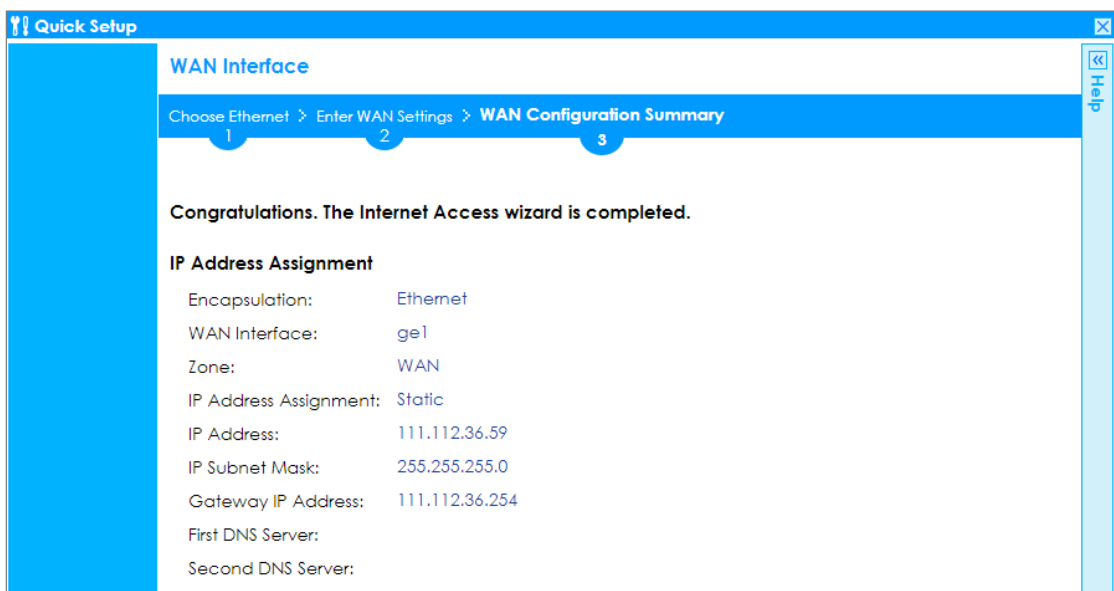

## Set Up the Internet Access (PPPoE) Wizard on the ZyWALL/USG

In the ZyWALL/USG **Installation Setup Wizard** Welcome page, click **Next** to start configuring for Internet. Click the double arrow in the upper right corner to display (<<) or hide (>>) the help.

### Installation Setup Wizard > Welcome

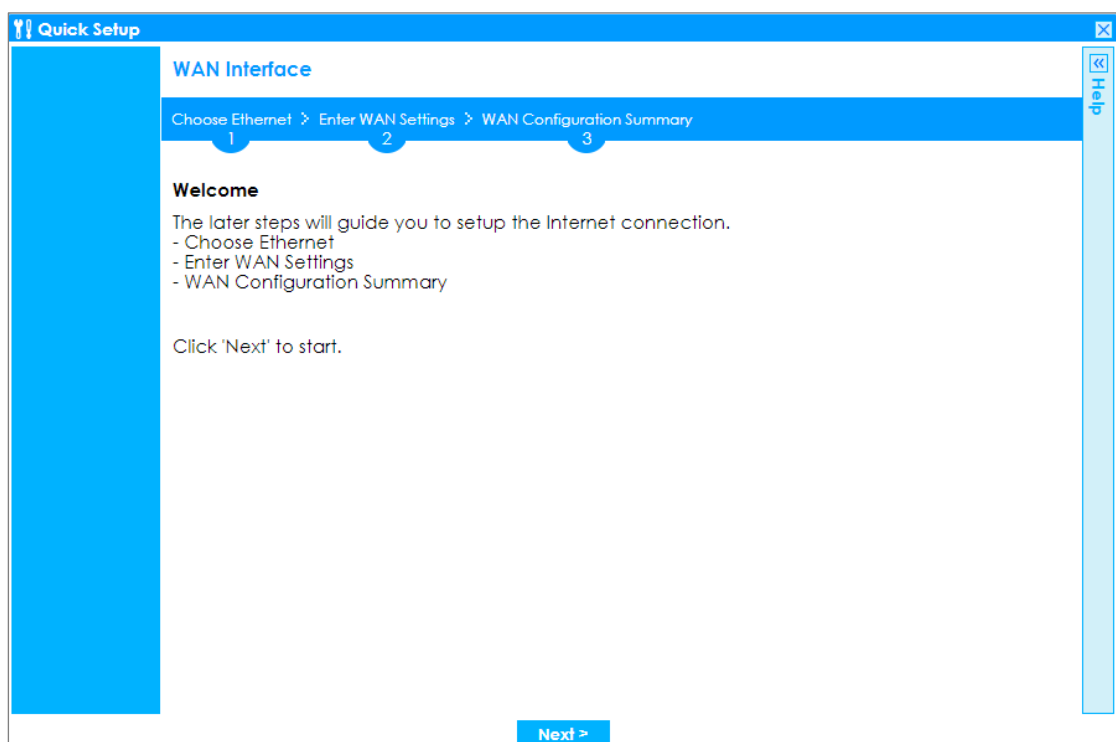

In the **Internet Access** page, you can configure Internet connections from two Internet service providers (ISPs). Connect your ISP devices to your ZyWALL/USG WAN port, select **I have two ISPs** if you want to configure two Internet connections or leave it cleared to configure just one.

Choose the **Encapsulation** option to be **PPP over Ethernet**, leave **Zone** as default setting Internet connection belongs to the WAN zone. Leave the **IP Address**

**Assignment** section to be the **Auto** and click **Next**.

**Installation Setup Wizard > Welcome > Internet Access**

The screenshot shows the 'WAN Interface' configuration page in the 'Quick Setup' wizard. The breadcrumb trail is 'Choose Ethernet > Enter WAN Settings > WAN Configuration Summary'. Step 1, 'Choose Ethernet', is highlighted. Under the 'Ethernet' section, the 'Ethernet Selection' dropdown menu is set to 'ge1'.

The screenshot shows the 'WAN Interface' configuration page in the 'Quick Setup' wizard. The breadcrumb trail is 'Choose Ethernet > Enter WAN Settings > WAN Configuration Summary'. Step 2, 'Enter WAN Settings', is highlighted. Under the 'IP Address Assignment' section, the 'WAN Type Selection' dropdown menu is set to 'PPPoE'.

The screenshot shows the 'WAN Interface' configuration page in the 'Quick Setup' wizard. The breadcrumb trail is 'Choose Ethernet > Enter WAN Settings > WAN Configuration Summary'. Step 3, 'WAN Configuration Summary', is highlighted. Under the 'Interface' section, the 'WAN Interface' is 'ge1\_ppp', the 'Zone' is 'WAN', and the 'IP Address Assignment' dropdown menu is set to 'Auto'.

Select the **Authentication Type** to be the authentication method by the remote node. Enter the **User Name** and **Password** exactly as given by your ISP or network administrator. Select **Nailed-UP** if you want to keep the connection always up or type the desired **Idle Timeout** value in seconds. Click **Next**.

**Installation Setup Wizard > Welcome > Internet Access**

**Quick Setup**

**WAN Interface**

Choose Ethernet > **Enter WAN Settings** > WAN Configuration Summary

1 2 3

**ISP Parameters**

Encapsulation: PPPoE

Service Name: (Optional)

Authentication Type: Chap/PAP

User Name : ZYXEL\_PPPoE

Password: .....

Retype to Confirm: .....

Nailed-Up

Idle timeout: 100 Seconds

**IP Address Assignment**

WAN Interface: ge1\_ppp

Zone: WAN

IP Address: Auto

**Note**

Configure PPPoE will change ethernet interface ip address as 0.0.0.0.

< Back Next >

The **Internet Access Succeed** page will display the summary of Internet access of the **First Setting**. If you select **I have two ISPs** in **Internet Access > ISP Setting**, click **Next** to configure the second WAN interface.

**Installation Setup Wizard > Welcome > Internet Access > Internet Access Succeed**

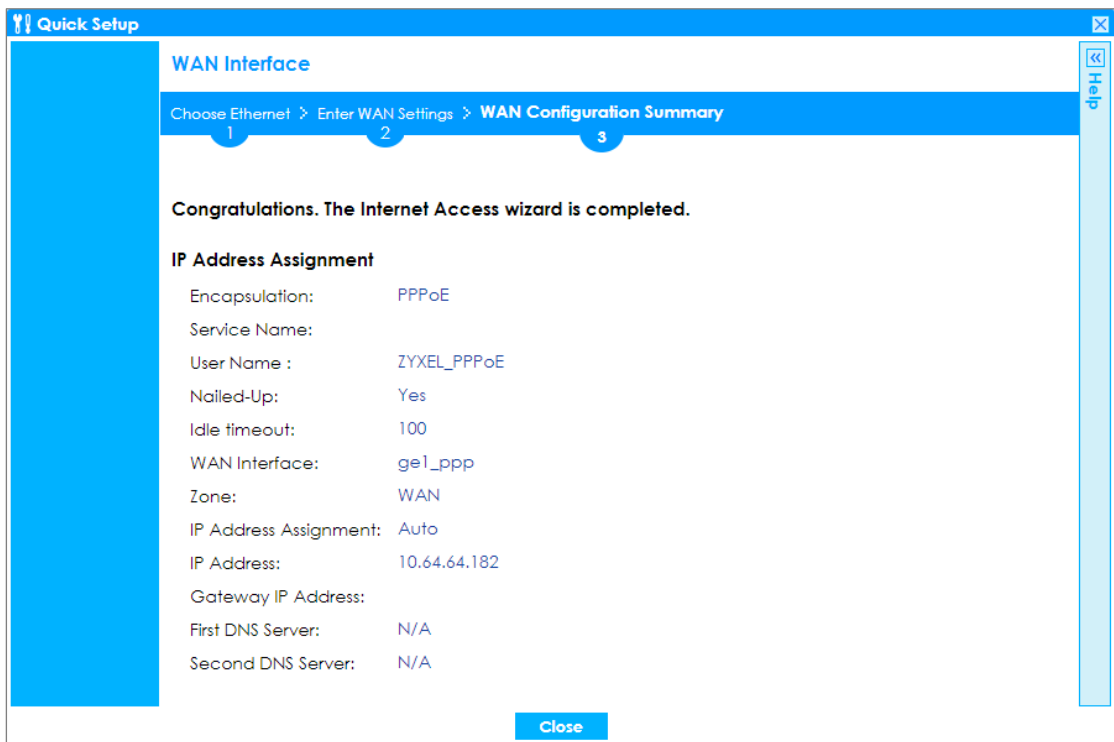

## Set Up the Internet Access (PPTP) Wizard on the ZyWALL/USG

In the ZyWALL/USG **Installation Setup Wizard** Welcome page, click **Next** to start configuring for Internet. Click the double arrow in the upper right corner to display (<<) or hide (>>) the help.

**Installation Setup Wizard > Welcome**

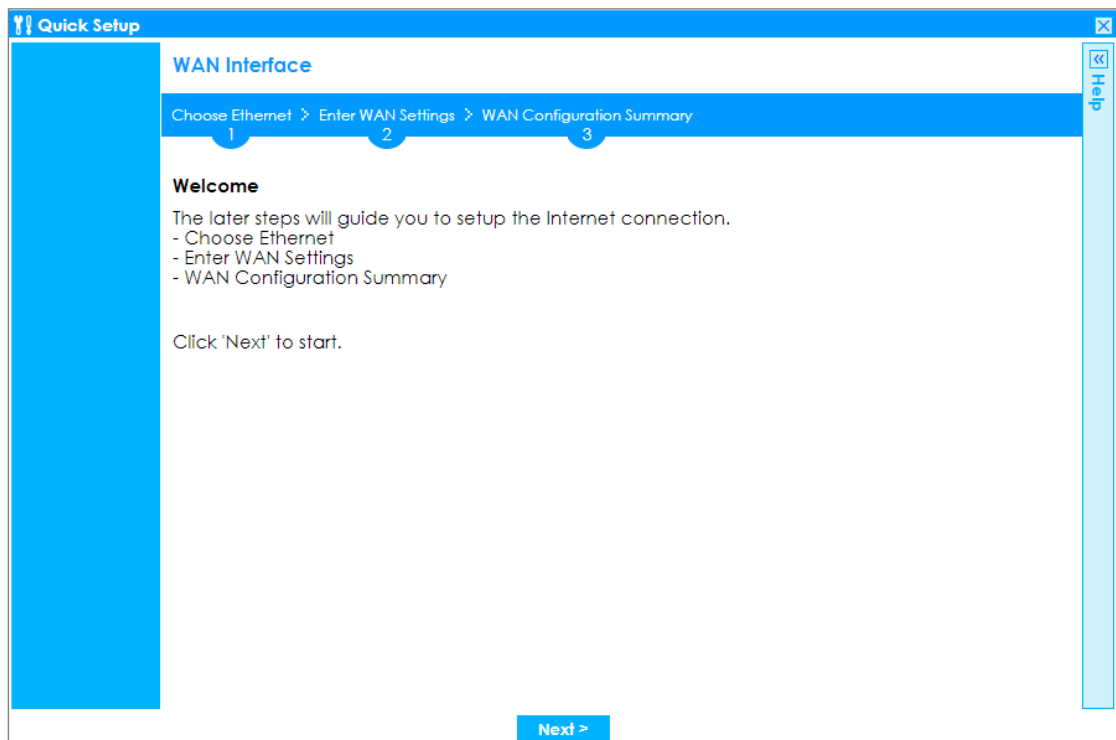

In the **Internet Access** page, you can configure Internet connections from two Internet service providers (ISPs). Connect your ISP devices to your ZyWALL/USG WAN port, select **I have two ISPs** if you want to configure two Internet connections or leave it cleared to configure just one.

Choose the **Encapsulation** option to be the **PPTP**, leave **Zone** as default setting Internet connection belongs to the WAN zone. Leave the **IP Address Assignment** section to be the **Auto** and click **Next**.

**Installation Setup Wizard > Welcome > Internet Access**

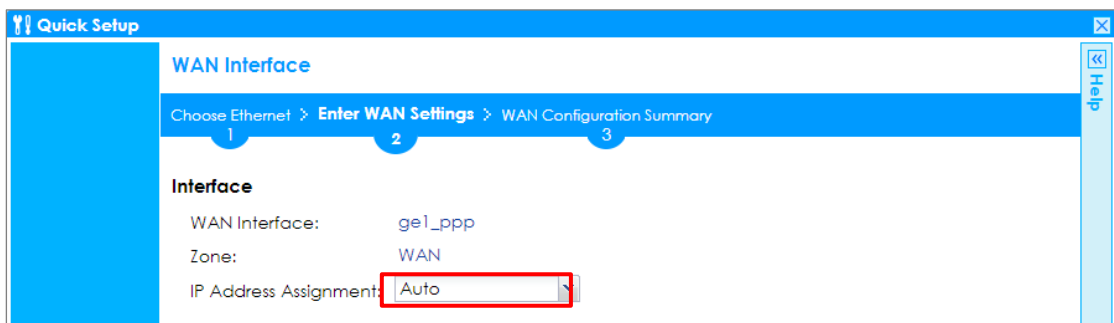
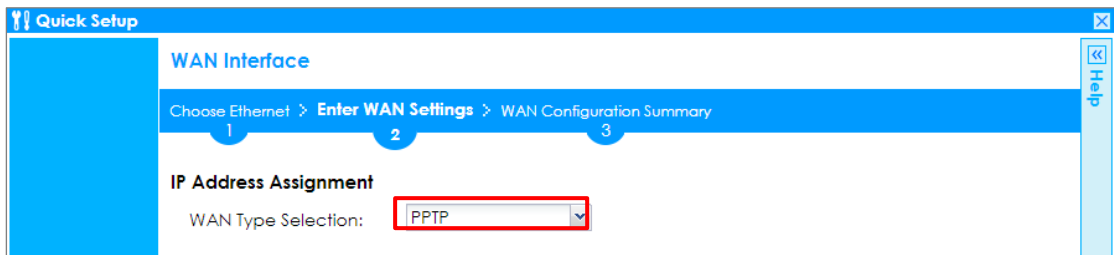

Select the **Authentication Type** to be the authentication method by the remote node. Enter the **User Name** and **Password** exactly as given by your ISP or network administrator. Select **Nailed-UP** if you want to keep the connection always up or type the desired **Idle Timeout** value in seconds. Click **Next**.

Enter the **Base IP Address**, **IP Subnet Mask**, **Gateway IP Address** assigned to you by your ISP. Type the **Server IP** address of the **PPTP Server**. Click **Next**.

**Installation Setup Wizard > Welcome > Internet Access**



**Quick Setup**

**WAN Interface**

Choose Ethernet > **Enter WAN Settings** > WAN Configuration Summary

1 2 3

**ISP Parameters**

Encapsulation: PPTP

Authentication Type: Chap/PAP

User Name : ZYXEL\_PPTP

Password: .....

Retype to Confirm: .....

Nailed-Up

Idle timeout: 100 Seconds

**PPTP Configuration**

Base Interface: ge1

Base IP Address: 111.111.36.99

IP Subnet Mask: 255.255.255.0

Gateway IP Address: 111.111.36.254 (Optional)

Server IP: 172.168.10.1 (Optional)

Connection ID: (Optional)

< Back Next >

The **Internet Access Succeed** page will display the summary of Internet access of the **First Setting**. If you select **I have two ISPs** in **Internet Access > ISP Setting**, click **Next** to configure the second WAN interface.

**Installation Setup Wizard > Welcome > Internet Access > Internet Access Succeed**

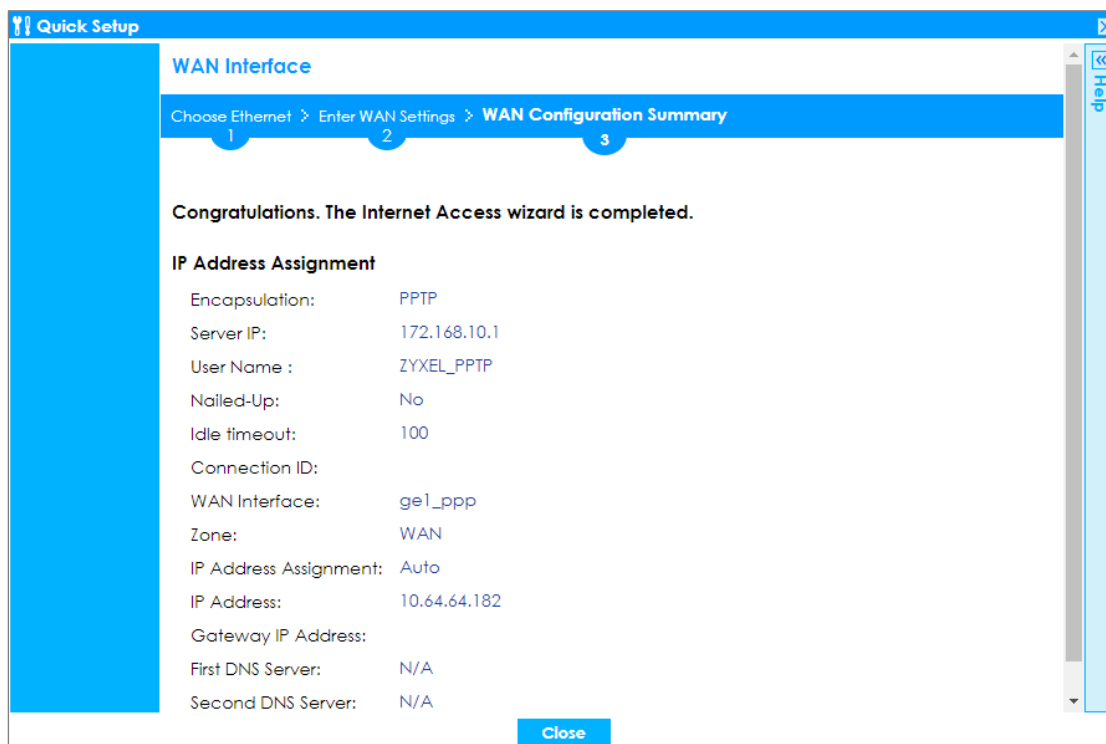

## Set Up the Wireless Settings Wizard on the ZyWALL/USG

In the **Wireless Settings** page, select **Yes** if you want the ZyWALL/USG to enable AP Controller feature in your network; select **No** if you want to skip this setting. Click **Next**.

**Installation Setup Wizard > Welcome > Internet Access > Internet Access Succeed > Wireless Settings**

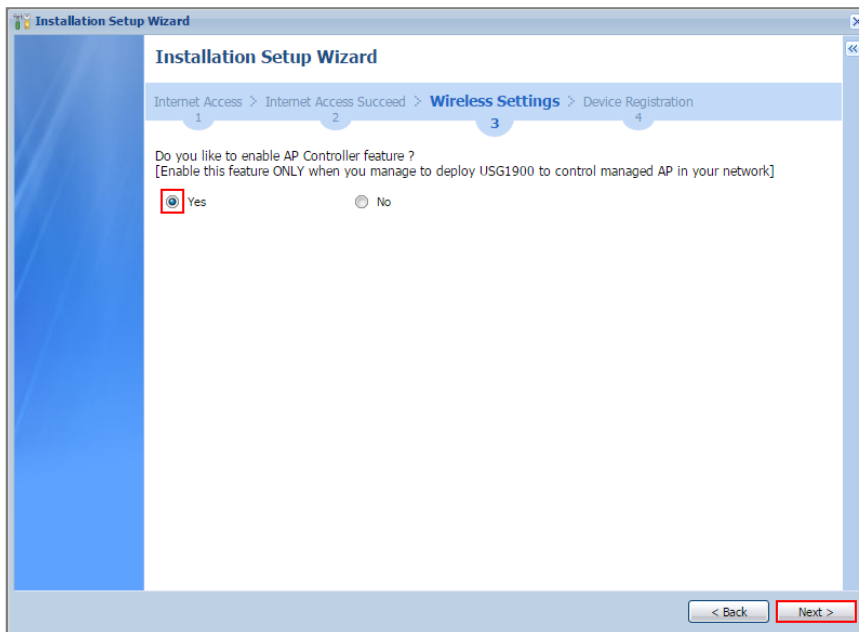

Configure descriptive **SSID** name (1-32 characters) for the wireless LAN. Select **Pre-Shared Key** (8-63 characters) to add security on this wireless network. Otherwise, select **None** to allow any wireless client to associate this network without authentication.

Select **Hidden SSID** to hide the SSID from site tool scanning.

Select **Enable Intra-BSS Traffic blocking** if you want to prevent crossover traffic from within the same wireless network. Wireless clients in that network can still access the wired network but cannot communicate with each other.

**For Built-in Wireless AP only**, ZyWALL/USGs with **W** in the model name have a built-in AP. Select an interface to bridge with the built-in AP wireless network. Devices connected to this interface will then be in the same broadcast domain as devices

in the AP wireless network.

**Installation Setup Wizard > Welcome > Internet Access > Internet Access Succeed > Wireless Settings**

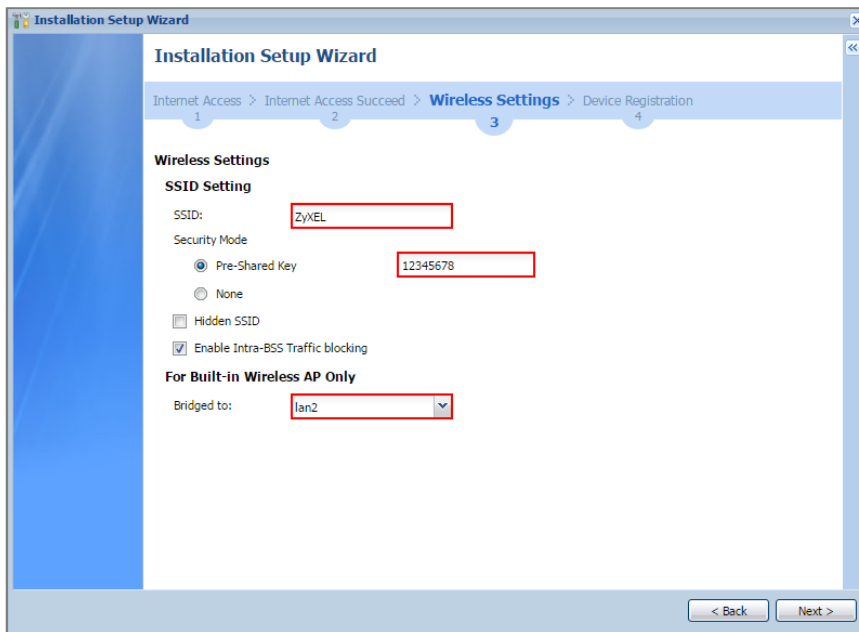

## Set Up the Device Registration on the ZyWALL/USG

The ZyWALL/USG must be connected to the Internet in order to register.

Click [portal.myzyxel.com](http://portal.myzyxel.com) to register the device, you need the ZyWALL/USG's serial number and LAN MAC address to register it. See **How To Register Your Device and**

Services at [myZyXEL.com](http://myZyXEL.com) for more details. Use the **Configuration > Licensing > Registration > Service** screen to update your service subscription status. Click **Finish**.

**Installation Setup Wizard > Welcome > Internet Access > Internet Access Succeed > Wireless Settings > Device Registration**

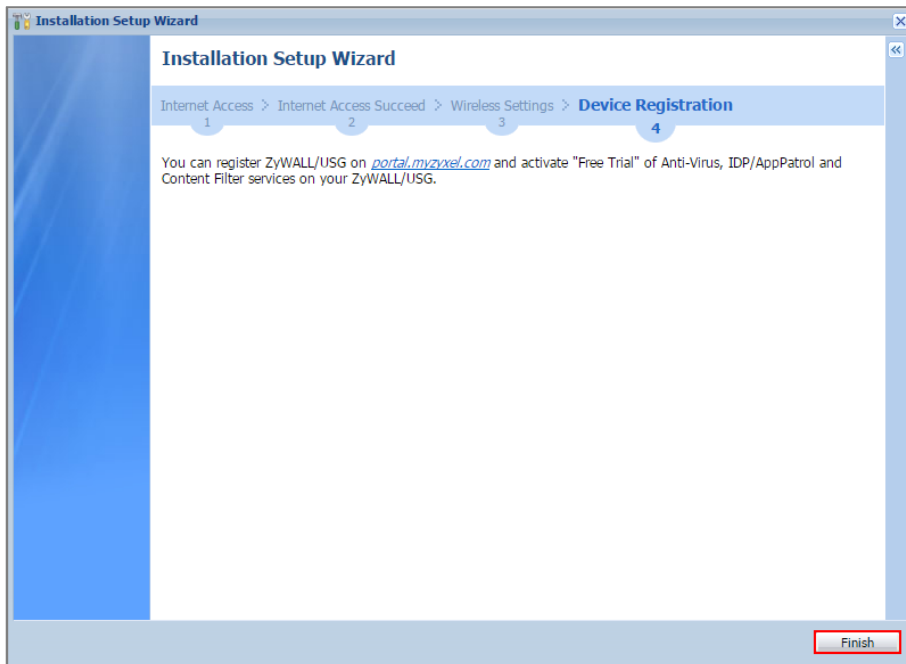

## How to Configure the 3G/LTE Interface on the ZyWALL/USG as a WAN Backup

This is an example of using ZyWALL/USG to configure 3G/LTE interface as a WAN backup that ensures the ZyWALL/USG provides the continuously Internet connections when the primary WAN interface is down. After configuration, it can provide additional mobile broadband WAN connectivity or a redundant link for maximum reliability.

ZyWALL/USG with 3G/LTE Interface as a WAN Backup Example

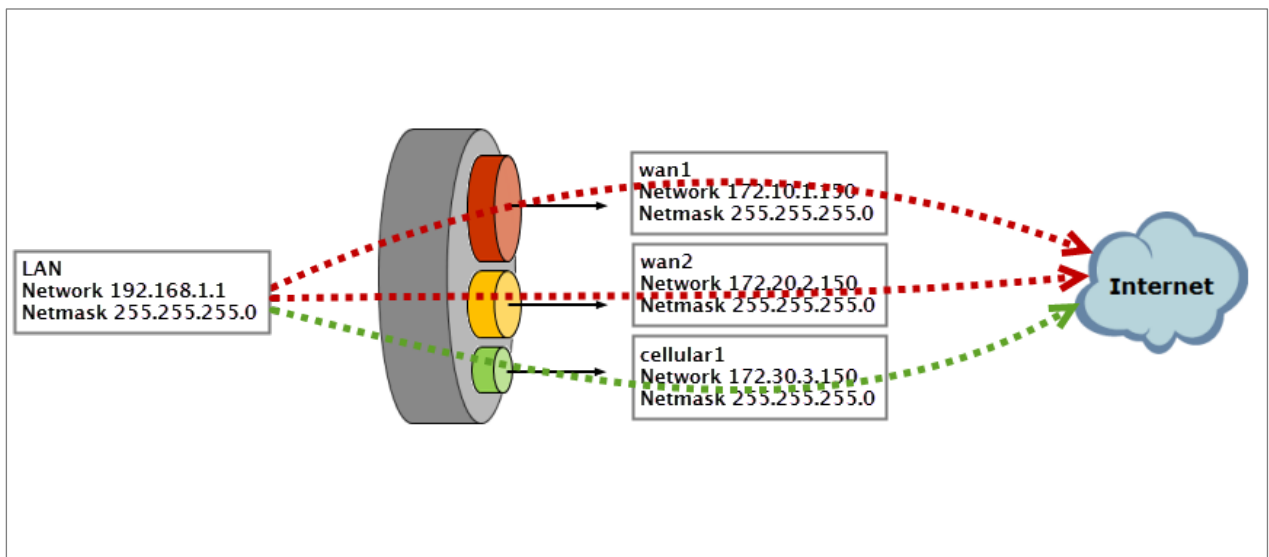

 Note: This example includes weighted load balancing (Weighted Round Robin) so that most of your Internet traffic is handled by ISP connected to wan1 before it fails over to 3G/LTE.

All network IP addresses and subnet masks are used as examples in this article. Please replace them with your actual network IP addresses and subnet masks. This example was tested using USG310 (Firmware Version: ZLD 4.25).

## Set Up the 3G/LTE Interface on the ZyWALL/USG

Connect a compatible mobile broadband USB device to use a cellular connection.

In the ZyWALL/USG, go to **CONFIGURATION > Network > Interface > Cellular**, the connected device will automatically display in the **Cellular Interface Summary**.

Click **Activate** and then the **Apply** button at the bottom of this page.

### CONFIGURATION > Network > Interface > Cellular > Activate

Cellular Interface Summary					
#	Status	Name	Extension Slot	Connected Device	ISP Settings
1		cellular1	USB 1	Huawei E3131	Device Profile 1

Page 1 of 1 | Show 50 items | Displaying 1 - 1 of 1

The default **Connectivity** method is **Nailed-Up**. The connection should always be up after you activate the cellular interface. You can click **Edit** and go to the **Connectivity** section to clear the **Nailed-Up** check box to have the ZyWALL/USG to establish the connection only when there is traffic.

### CONFIGURATION > Network > Interface > Cellular > Connect

Cellular Interface Summary					
#	Status	Name	Extension Slot	Connected Device	ISP Settings
1		cellular1	USB 1	Huawei E156G	

Page 1 of 1 | Show 50 items | Displaying 1 - 1 of 1

### CONFIGURATION > Network > Interface > Cellular > Edit

Connectivity	
<input checked="" type="checkbox"/>	Nailed-Up

## Set Up the Trunk on the ZyWALL/USG

In the ZyWALL/USG, go to **CONFIGURATION > Network > Interface > Trunk > User Configuration > Add Trunk**, configure a **Name** for you to identify the Trunk profile and set the **Load Balancing Algorithm** field to be the **Weighted Round Robin**.

Add **wan1** and enter **3** in the **Weight** column. Add **wan2** and enter **2** in the **Weight** column. Add **cellular1**, change **Mode** to be the **Passive** mode, enter **1** in the **Weight** column. Click **OK** to return to the **Configuration** screen.

**CONFIGURATION > Network > Interface > Trunk > User Configuration > Add Trunk**

**Edit WAN\_backup**

Name: WAN\_backup

Load Balancing Algorithm: Weighted Round Robin

#	Member	Mode	Weight
1	ge1	Active	1
2	cellular1	Passive	0
3	ge2	Active	2

Page 1 of 1 | Show 50 items | Displaying 1 - 3 of 3

In the **Configuration** screen, go to **Default WAN Trunk** section, select **User Configured Trunk** and select the newly created Trunk from the list box. Click **Apply**.

**CONFIGURATION > Network > Interface > Trunk > Default WAN Trunk > User Configured Trunk**



**Default WAN Trunk**

Advance

Default Trunk Selection

SYSTEM\_DEFAULT\_WAN\_TRUNK  
 User Configured Trunk: WAN\_Backup

## Test the Result

Check the **Interface Statistics** when wan1 and wan2 connections are up. You can see both wan1 and wan2 **Status** are up, **Tx B/s** displays the transmission speed and **Rx B/s** displays the reception speed; cellular1 **Status** is connected but there is no traffic going through this interface.

### MONITOR > Interface Status > Interface Statistics

**Interface Statistics**

Name	Status	TxPkts	RxPkts	Tx B/s	Rx B/s
wan1	1000M/Full	359860	1314443	2587	1152
wan2	100M/Full	2438	23927	192	64
ge3	Down	0	0	0	0
ge4	Down	0	0	0	0
ge5	Down	0	0	0	0
ge6	Down	0	0	0	0
ge7	Down	0	0	0	0
ge8	Down	0	0	0	0
cellular1	Connected	0	0	0	0

After disconnecting both wan1 and wan2, you can see both wan1 and wan2 **Status** are **Down** and no traffic goes through these two interfaces. The backup cellular1 **Status** is connected and all the traffic is going through this interface.

## MONITOR > Interface Status > Interface Statistics

Interface Statistics						
Refresh						
Name	Status	TxPkts	RxPkts	Tx B/s	Rx B/s	
+ ge1	Down	0	0	0	0	
+ ge2	1000M/Full	6764	35208	0	0	
+ ge3	Down	1	0	0	0	
+ ge4	Down	2	0	0	0	
+ ge5	Down	1	0	0	0	
+ ge6	Down	2	0	0	0	
+ ge7	Down	1	0	0	0	
+ ge8	Down	1	0	0	0	
- cellular1	Connected (00:10:34)	164	119	0	0	

## What Could Go Wrong?

If there is no traffic going through cellular interface when other interfaces are down, please make sure you have a compatible mobile broadband device installed or connected. Go to

[http://www.zyxel.com/support/download\\_landing.shtml](http://www.zyxel.com/support/download_landing.shtml) and see the **3G Dongle Document** to check the compatible mobile broadband devices. Also, make sure the cellular interface is enabled and the cellular interface has the correct user name, password, and PIN code configured with the correct casing.

## How to Configure Two Different WAN Interfaces with Different IP Addresses in the Same VLAN

This is an example of using ZyWALL/USG to configure two different WAN interfaces with different IP addresses in the same VLAN. After configuration, you can have the same VLAN ID for two different WAN interfaces.

ZyWALL/USG with Two Different WAN Interfaces with Different IP Addresses in the Same VLAN Example

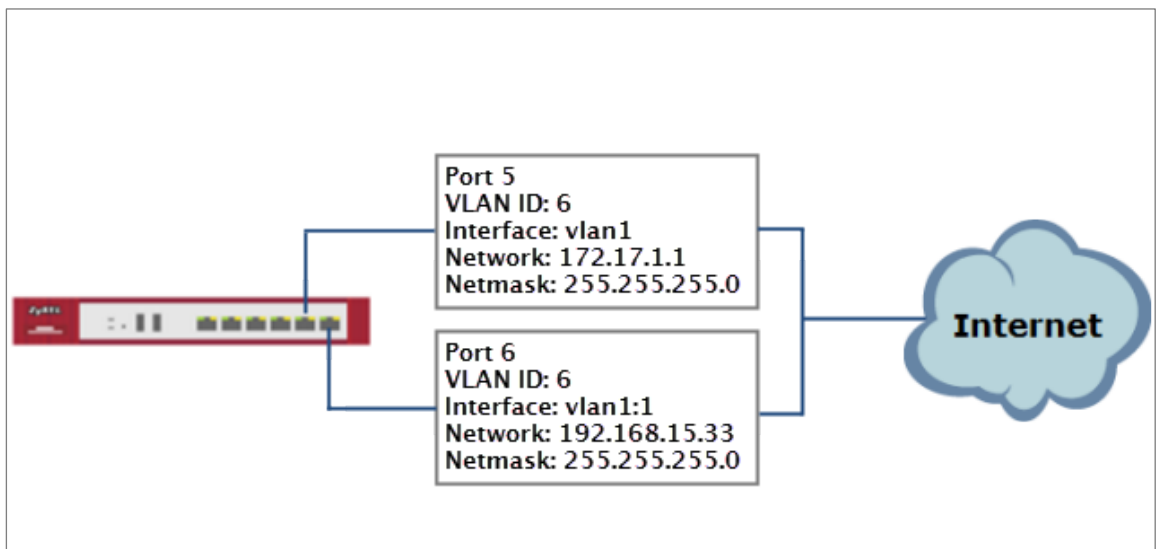

 Note: This example requires the ZyWALL/USG models which can apply port grouping. All network IP addresses and subnet masks are used as examples in this article. Please replace them with your actual network IP addresses and subnet masks. This example was tested using ZyWALL USG300 (Firmware Version: ZLD 4.25).

## Set Up the Port Grouping on the ZyWALL/USG

In the ZyWALL/USG, go to **CONFIGURATION > Network > Interface > Port Grouping**, select the ports that you want to assign to a representative Interface (in this example, **Port 4** and **Port 5** are configured as **ge5**).

**CONFIGURATION > Network > Interface > Port Grouping**

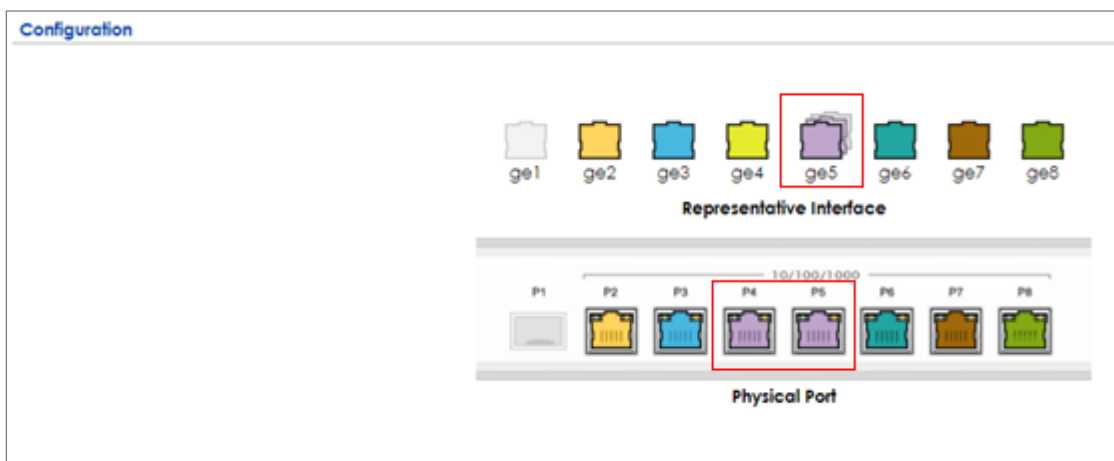

## Set Up the VLAN on the ZyWALL/USG

In the ZyWALL/USG, go to **CONFIGURATION > Network > Interface > VLAN**. Set **Interface Type** to be **External**. Set **Zone** to be **WAN**, configure **Base Port** to be **ge5**. Enter the **VLAN ID** and configure the fixed IP address (172.17.1.1/24 in this example). Click **OK** to go back to the **Configuration** page.

**CONFIGURATION > Network > Interface > VLAN**

**General Settings**

Enable Interface

---

**Interface Properties**

Interface Type: external ⓘ

Interface Name: vlan1

Zone: none ⓘ

Base Port: ge5

VLAN ID: 1 (1-4094)

Advance

Description:  (Optional)

**IP Address Assignment**

Get Automatically

Advance

Use Fixed IP Address

IP Address: 172.17.1.1

Subnet Mask: 255.255.255.0

Gateway: 172.17.1.254 (Optional)

Metric:  (0-15)

In the **Configuration** page, select the **vlan1** entry and click **Create Virtual Interface** on the upper bar. Configure the Fixed IP address (192.168.15.33/24 in this example). Click **OK**.

**CONFIGURATION > Network > Interface > VLAN > vlan1**

#	Status	Name	Port/VID	IP Address	Mask
1	<span style="color: orange;">⚡</span>	vlan1	ge5/1	static-172.17.1.1	255.255.255.0

Page 1 of 1 | Show 50 items | Displaying 1 - 1 of 1

**CONFIGURATION > Network > Interface > VLAN > vlan1:1**

**Interface Properties**

Interface Name: vlan1:1

Description:  (Optional)

---

**IP Address Assignment**

IP Address: 192.168.15.33

Subnet Mask: 255.255.255.0

Gateway: 192.168.15.1 (Optional)

Metric:  (0..15)

## Set Up the Routing on the ZyWALL/USG

In the ZyWALL/USG, go to **CONFIGURATION > Network > Routing**, set **Next-Hop Type** to be **Interface** and set **Interface** to be the **vlan1**.

**CONFIGURATION > Network > Routing**

Configuration	
<input checked="" type="checkbox"/> Enable	
Description:	Vlan_Routing (Optional)
Criteria	
User:	any
Incoming:	any (Excluding ZyV)
Source Address:	any
Destination Address:	any
DSCP Code:	any
Schedule:	none
Service:	any
Next-Hop	
Type:	interface
Interface:	vlan1

## Test the Result

Check the **Interface Statistics**, you can see **vlan1 Status** is up, **Tx B/s** displays the transmission speed and **Rx B/s** displays the reception speed. Port 5 and Port 6 are configured in the same **vlan1** but use different IP addresses.

**MONITOR > Interface Status > Interface Statistics**



Interface Statistics

Refresh

Name	Status	TxPkts	RxPkts	Tx B/s	Rx B/s
ge1	Down	0	0	0	0
ge2	1000M/Full	9269	14934	0	94
ge3	Down	2	0	0	0
ge4	Down	12951	11412	0	0
ge5	Up	2150	2117	16803	1901
- vlan1	Up	326	0	42	0
- ge5_ppp	Inactive			0	0
ge6	Down	4	0	0	0
ge7	Down	2	0	0	0
ge8	Down	1	0	0	0

## What Could Go Wrong?

If you cannot configure a particular VLAN interface on top of an Ethernet interface, please whether this VLAN has just been created on top of other Ethernet interface.

## How to Let a Server Use the Same Public IP Address as the WAN Interface Using the Bridge Interface

This is an example of using ZyWALL/USG to configure an internal server in bridge mode without applying network address translation (NAT). The Internet users can

reach this server directly by its public IP address.

## ZyWALL/USG with Bridge Interface Example

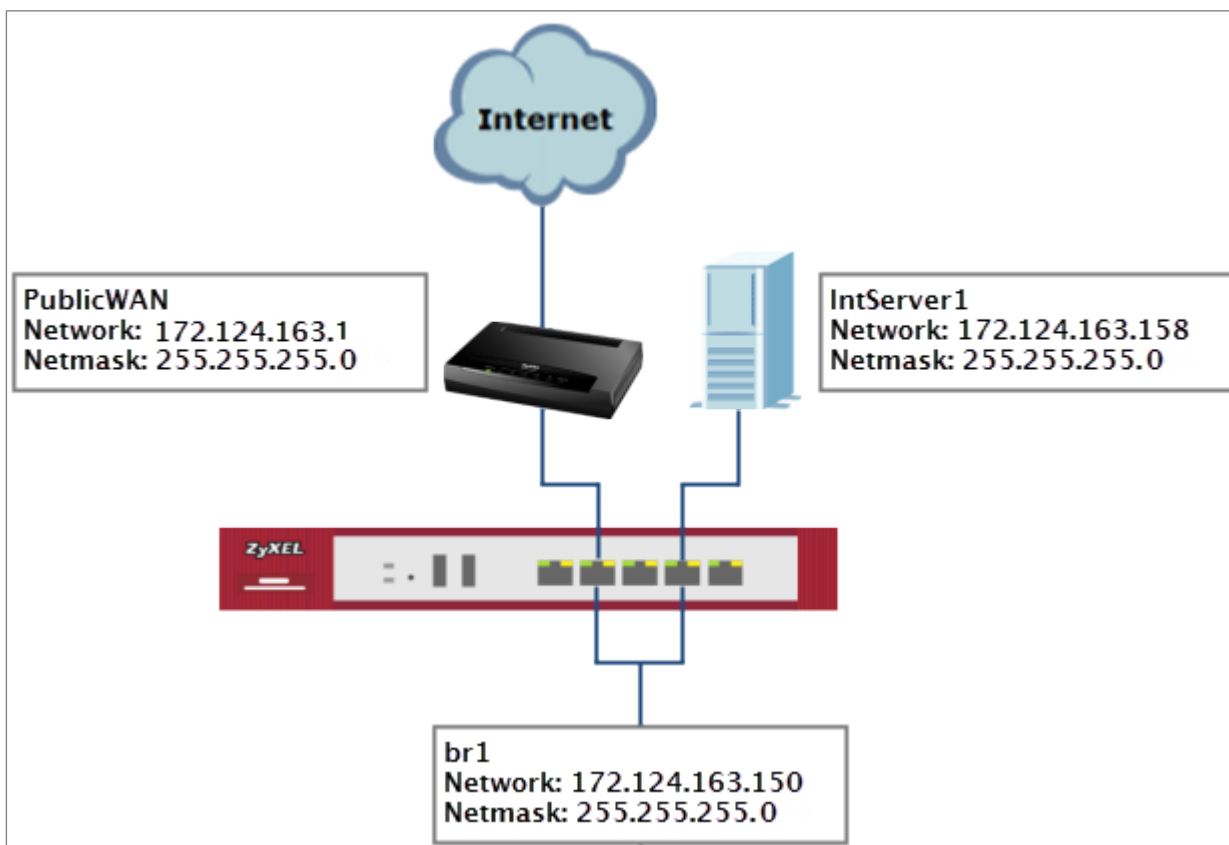

 Note: All network IP addresses and subnet masks are used as examples in this article. Please replace them with your actual network IP addresses and subnet masks. This example was tested using USG310 (Firmware Version: ZLD 4.25).

## Set Up the Bridge Interface on the ZyWALL/USG

In the ZyWALL/USG, go to **CONFIGURATION > Network > Interface > Bridge > add**



**Bridge**, select **Interface Type** to be the **general** type, select **Zone** to be the **LAN** zone. In the **Member Configuration**, select internal server (**IntServer1** interface in this example) and public IP address (**Public WAN** interface in this example) to be in the same member group.

In the **IP Address Assignment** section, select **Used Fixed IP Address** and configure br1 IP address (172.124.163.150/24 in this example).

**CONFIGURATION > Network > Interface > Bridge > add Bridge**

**General Settings**

Enable Interface

---

**Interface Properties**

Interface Type: general ⓘ

Interface Name:

Zone: LAN ⓘ

Description:  (Optional)

---

**Member Configuration**

Available		Member
ge1	+ +	
ge2		
ge3		
ge4		
ge5		
IntServer1		
PublicWAN		

---

**IP Address Assignment**

Get Automatically

Advance

Use Fixed IP Address

IP Address: 172.124.163.150

Subnet Mask: 255.255.255.0

Gateway: 172.124.163.129 (Optional)

Metric:  (0-15)

After creating the bridge interface, connect the server's network cable to **IntServer1** port and set the server's IP to be in the same subnet (172.124.163.158 in this example).

## Test the Result

Check the **Interface Statistics**, you can see br1 **Status** is up, **Tx B/s** displays the transmission speed and **Rx B/s** displays the reception speed. **IntServer1** and **PublicWAN** are configured in the same vlan1 but using different IP address.

### MONITOR > Interface Status > Interface Statistics

Interface Statistics						
Refresh						
Name	Status	TxPkts	RxPkts	Tx B/s	Rx B/s	
ge1	Down	0	0	0	0	
ge2	1000M/Full	9877	17204	0	0	
ge3	Down	2	0	0	0	
ge4	1000M/Full	13950	13611	0	0	
ge5	Down	2434	2372	0	0	
ge6	Down	4	0	0	0	
IntServer1	Down	1329	1120	0	0	
PublicWAN	1000M/Full	1135	1320	0	0	
- br1	Up	14	618	0	0	

Server can access Internet successfully by using its IP address (172.124.163.158 in this example) and Internet users can also reach this server by this public address as well.

### Windows 7 > cmd > ping 172.124.163.158

```
C:\Documents and Settings\ZyXEL-CS0>ping 172.124.163.158

Pinging 172.124.163.158 with 32 bytes of data:

Reply from 172.124.163.158: bytes=32 time=37ms TTL=44
Reply from 172.124.163.158: bytes=32 time=26ms TTL=44
Reply from 172.124.163.158: bytes=32 time=32ms TTL=44
Reply from 172.124.163.158: bytes=32 time=22ms TTL=44

Ping statistics for 172.124.163.158:
    Packets: Sent = 4, Received = 4, Lost = 0 (0% loss),
    Approximate round trip times in milli-seconds:
        Minimum = 0ms, Maximum = 0ms, Average = 0ms
```

## What Could Go Wrong?

If you cannot configure a particular bridge IP address, please check if this IP address already created on other Ethernet interface.

## How to Allow Public Access to a Server Behind ZyWALL/USG

This is an example of using ZyWALL/USG to configure a securely access to internal server behind ZyWALL/USG with network address translation (NAT). The Internet users can reach this server directly by its public IP address and a NAT mapping rule will forward the traffic from the Internet to the Intranet. It provides security and decrease the number of IP addresses an organization needs.

ZyWALL/USG enables Public Access to a Server with NAT

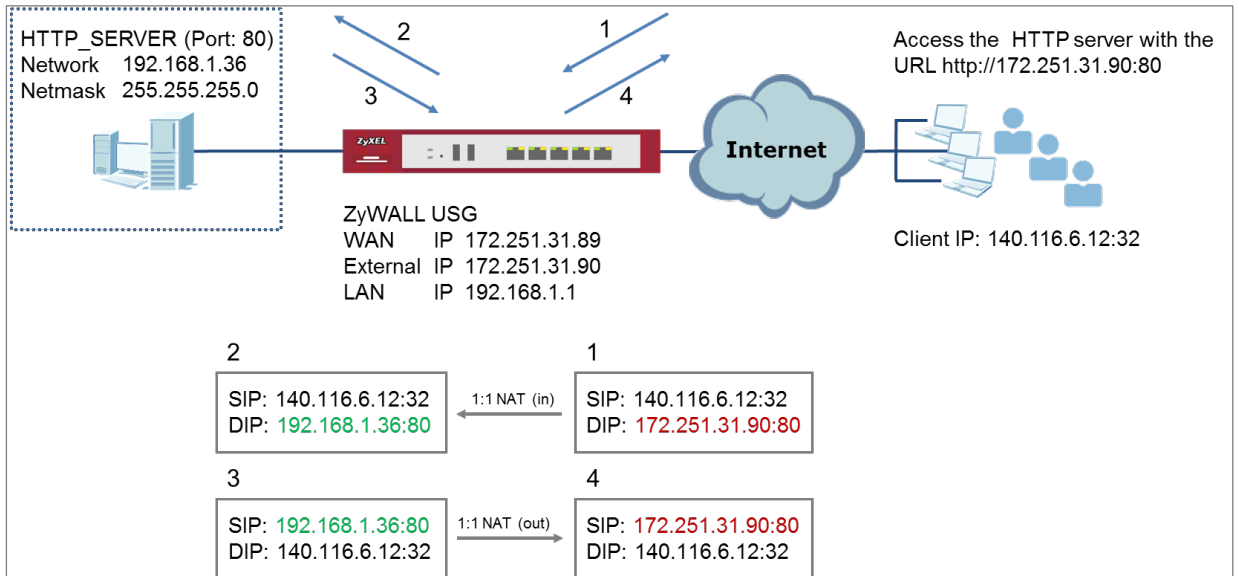

Note: All network IP addresses and subnet masks are used as examples in this article. Please replace them with your actual network IP addresses and subnet masks. This example was tested using USG310 (Firmware Version: ZLD 4.25).

## Set Up the NAT on the ZyWALL/USG

In the ZyWALL/USG, go to **CONFIGURATION > Network > NAT > add NAT**, select **Enable Rule**. Select **1:1 NAT**. Set **Incoming Interface** to be the **wan1** interface. Type **User-Defined Original IP** (172.251.31.90 in this example) and type **User-Defined Mapped IP** (192.168.1.34 in this example). Set **Port Mapping Type** to **Service**, set **Original Service** and **Mapped Service** to **HTTP** in this example. Click **OK**.

**CONFIGURATION > Network > NAT > add NAT**

<b>General Settings</b>	
<input checked="" type="checkbox"/> Enable Rule	
Rule Name:	http_server
<b>Port Mapping Type</b>	
Classification:	<input type="radio"/> Virtual Server <input checked="" type="radio"/> 1:1 NAT <input type="radio"/> Many 1:1 NAT
<b>Mapping Rule</b>	
Incoming Interface:	ge1
Original IP:	User Defined
User-Defined Original IP:	172.251.31.90 (IP Address)
Mapped IP:	User Defined
User-Defined Mapped IP:	192.168.1.34 (IP Address)
Port Mapping Type:	any

## Set Up the Security Policy on the ZyWALL/USG

In the ZyWALL/USG, go to **CONFIGURATION > Security Policy > Policy Control > add corresponding**, select **Enable**. Configure a Name for your to identify the security policy (http\_server\_access in this example). Set **From: WAN** and **To: LAN1**. Set **Destination** to the lan subnet where your server is (LAN\_SUBNET\_GE3 in this example). Set **Service** to **HTTP**, set **Action** to **allow**. Click **OK**.

**CONFIGURATION > Security Policy > Policy Control > add corresponding**

<input checked="" type="checkbox"/> Enable	
Name:	http_server_access
Description:	(Optional)
From:	WAN
To:	LAN1
Source:	any
Destination:	LAN_SUBNET_GE4
Service:	HTTP
User:	any
Schedule:	none
Action:	allow
Log matched traffic:	no

## Test the Result

Type <http://172.251.31.90/> into the browser, it displays the HTTP service page.

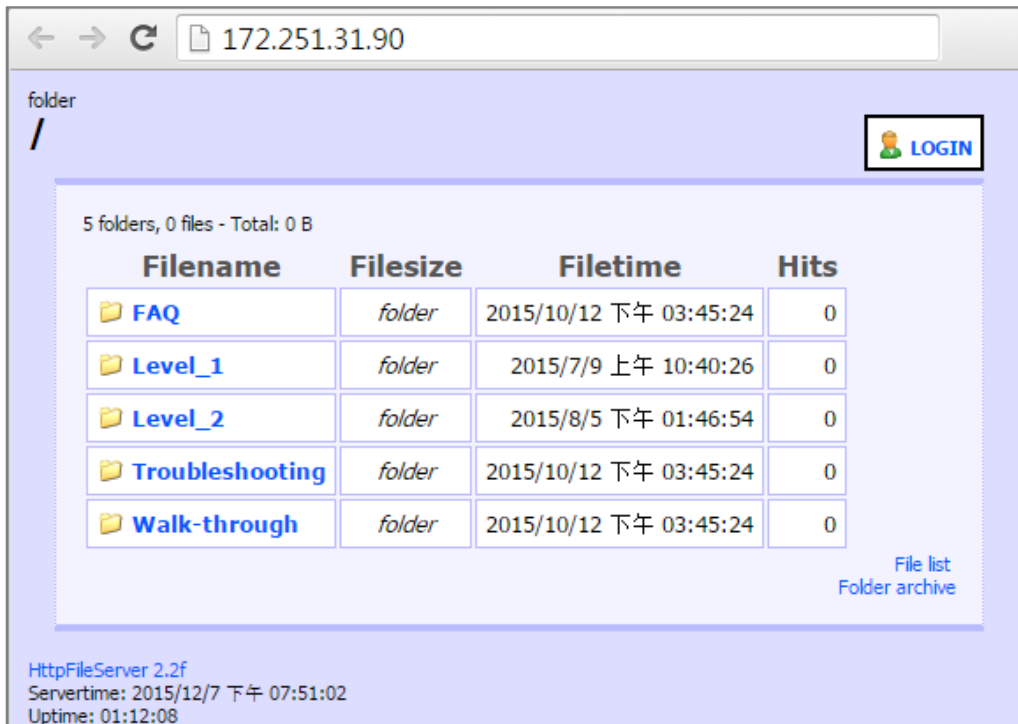

## What Could Go Wrong?

If you cannot access your server via public IP address, please make sure all your public IP addresses are routing properly. To do one by one assign them to the ZyWALL's WAN port. Test to make sure you have internet access with the public IP address.

If you cannot access the ZyWALL from the internet with any IP address on your public IP, this is a routing issue on the service end. Please contact the ISP to fix the

routing for the public IPs.

If you see [notice] log message as below, the HTTPS traffic is blocked by the priority 1 Security Policy. The ZyWALL/USG checks the security policy in order and applies the first security policy the traffic matches. If the HTTPS traffic matches a policy that comes earlier in the list, it may be unexpectedly blocked. Please change your policy setting or move the policy to the higher priority.

### Monitor > Log

# ^	Priority	Category	Message	Note
1	notice	Security Policy Control	priority:1, from LAN to ANY, TCP, service HTTPS, REJECT [count=3]	ACCESS BLOCK
2	notice	Security Policy Control	priority:1, from LAN to ANY, TCP, service HTTPS, REJECT [count=3]	ACCESS BLOCK

 Note: The default setting of **Security Policy** is without log notification (except **PolicyDefault**), if you want to check which policy may potentially block the traffic, please select this policy and set the **Log matched traffic** to be **log** or **log alert**.

## How to Set Up a WiFi Network with ZyXEL APs

This is an example of using ZyWALL/USG to manage the Access Points (APs) and allow wireless access to the network.

ZyWALL/USG as AP Controller Example

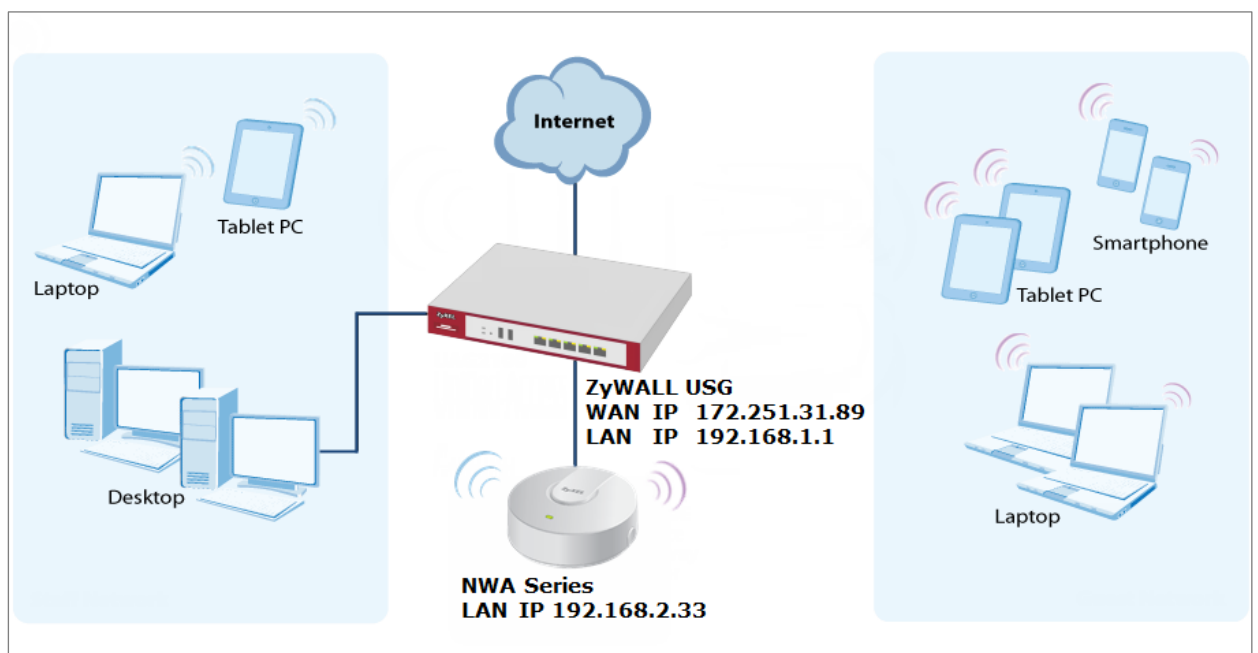

 Note: All network IP addresses and subnet masks are used as examples in this article. Please replace them with your actual network IP addresses and subnet masks. This example was tested using USG310 (Firmware Version: ZLD 4.25).



## Set Up the AP Management on the ZyWALL/USG

In the ZyWALL/USG, go to **CONFIGURATION > Wireless > Controller > Configuration**, set **Registration Type** to **Manual**. This is recommended as the registration mechanism cannot automatically differentiate between friendly and rogue APs.

**CONFIGURATION > Wireless > Controller > Configuration**

**Controller Setting**

Country Code:

Registration Type:  **Manual**  Always Accept

Connect the ZyXEL AP unit to the lan interface.

Go to **MONITOR > Wireless > AP Information > AP List** and the ZyXEL AP is listed. A green question mark displays in the Status column since the AP is not yet managed by the ZyWALL/USG. Select the listed AP and click **Add to Mgnt AP List** on the upper bar.

**Monitor > Wireless > AP Information > AP List**

#	Status	Descriptio...	CPU ...	IP Address	Model	Group	Station	Rece...	Regis...	MAC Add...	Mgnt...	Last ...	LED st...	Pow...
1		AP-58:8B:F...		192.168.2.33	NWA...		0		Un-M...	58:8B:F3:9...	0 / -			N/A

Page 1 of 1 | Show 50 items | Displaying 1 - 1 of 1



Note: The APs may take few minutes to appear in the AP List.

Go to **CONFIGURATION > Object > AP Profile > SSID > SSID List** to configure a name to identify the **SSID**.

**CONFIGURATION > Object > AP Profile > SSID > SSID List**

Profile Name:	default
SSID:	ZyXEL_API
Security Profile:	default
MAC Filtering Profile:	disable
QoS:	WMM
Rate Limiting (Per Station Traffic Rate) ⓘ	
Downlink:	0 mbps (0~160, 0 is unlimited)
Uplink:	0 mbps (0~160, 0 is unlimited)
Band Select:	disable
Forwarding Mode:	Local bridge
VLAN ID:	1 (1~4094)
<input type="checkbox"/> Hidden SSID	
<input type="checkbox"/> Enable Intra-BSS Traffic blocking	
<input type="checkbox"/> Schedule SSID ⓘ	

Go to **CONFIGURATION > Object > AP Profile > SSID > Security List** to select the **Security Mode** to be the **wpa2**. Then, set a **Pre-Shared Key** (8-63 characters) and select the **Cipher Type** to be the **auto** to have ZyWALL/USG automatically chooses the best available cipher based on the cipher currently in use by the wireless network. Click **OK**.

**CONFIGURATION > Object > AP Profile > SSID > Security List**

<b>General Settings</b>	
Profile Name:	default
Security Mode:	wpa2

**Authentication Settings**

802.1X  
 Auth. Method:   
 ReAuthentication Timer:  (30~30000 seconds, 0 is unlimited)

PSK  
 Pre-Shared Key:   
 Cipher Type:   
 Idle timeout:  (30-30000 seconds)  
 Group Key Update Timer:  (30-30000 seconds)

Management Frame Protection   
  Optional   
  Required

## Test the Result

Go to the ZyWALL/USG **Monitor > Wireless > AP Information > AP List**, you can check the list of APs which are currently connected to it and the details information such as **Registration** type, **Model** and **Recent On-line Time /Last Off-line Time**.

**MONITOR > Wireless > AP Information > AP List**

**AP List**

[Config AP](#)  
 [+ Add to Mgnt AP List](#)  
 [More Information](#)  
 [Reboot](#)  
 [DCS Now](#)  
 [Log](#)  
 [Suppression On](#)  
 [Suppression Off](#)

#	Status	Description	IP Address	Model	Registration	MAC Address	LED status	Power Mode
1		AP-58:8B:F3:91:6B:C7	192.168.2.33	NWA5123-AC	Un-Mgnt AP	58:8B:F3:91:6B:C7	N/A	

Page 1 of 1    Show 50 items    Displaying 1 - 1 of 1

Go to the ZyWALL/USG **Monitor > Wireless > Station Info > Station List**, you can check the list of wireless stations associated with a managed AP and the details information such as **SSID Name**, **Signal Strength** and the transmit (**Tx**)/receive (**Rx**) data rate.

**MONITOR > Wireless > Station Info > Station List**

**Station List**

#	MAC Address	Associat...	SSID Name	Security ...	Signal Strength	Channel	Band	IP Address	Tx R...	Rx R...	Tx	Rx
1	04:4B:ED:85:6...	AP-588BF...	ZyXEL	NONE	-65dBm	6	2.4G	192.168.2...	15M	32M	102177	49447

Page 1 of 1    Show 50 items    Displaying 1 - 1 of 1

Using a mobile device to connect to SSID: **ZyXEL\_AP1** and type the password (zyxel123) for authentication. Go to the ZyWALL/USG **Monitor > Log**, you will see [info] log message as shown below. The ZyWALL/USG will assign an IP address to

the mobile device and the mobile device can access the Internet.

## MONITOR > Log

349	info	DHCP	DHCP server assigned 192.168.1.33 to TWNBZT02643-02(30:65:EC:49:85:EA...	DHCP ACK
350	info	DHCP	Requested 192.168.1.33 from TWNBZT02643-02(30:65:EC:49:85:EA) [count...	DHCP Request

## What Could Go Wrong?

If you can't see AP information in the AP List, please check the number of APs connected to the ZyWALL/USG has exceeded the maximum Managed AP number it can support. You can check the maximum support number of each ZyWALL/USG in the Datasheet from ZyXEL Download Library -

[http://www.zyxel.com/support/download\\_landing.shtml](http://www.zyxel.com/support/download_landing.shtml)

If your mobile device can't find the AP SSID you configured, please go to **CONFIGURATION > Object > AP Profile > SSID > SSID List** and check if the **Hidden SSID** option is enabled.

If your mobile device can't access to the Internet via AP connects to the ZyWALL/USG, please check if the LAN outgoing security policy allow access to the Internet.

If your mobile device is not connected to the AP automatically even you've joined the Wifi network before and you see [Wlan Station Info] log message as shown below, please check if this AP is removed from your mobile device's saved Wifi network list.

## MONITOR > Log

#	Priority	Category	Message	Note
17	info	Wlan Station Info	STA Disassociation(8:DISASSOC_STA_HAS_LEFT) by STA Logout. MA...	
100	info	Wlan Station Info	STA Disassociation(3:DEAUTH_LEAVING) by STA Logout. MAC:D4:9...	
10	info	Wlan Station Info	STA Disassociation(3:DEAUTH_LEAVING) by STA Logout. MAC:D4:9...	
105	info	Wlan Station Info	STA Disassociation(3:DEAUTH_LEAVING) by STA Logout. MAC:D4:9...	

## **How to Set Up Guest WiFi Network Accounts**

This is an example of using ZyWALL/USG to configure guest WiFi accounts to allow limited wireless access to the Internet using only HTTP, HTTPS, and DNS protocols. For the wireless network setup, please see the tutorial about How to Set Up WiFi with ZyXEL AP.

ZyWALL/USG with Guest WiFi Accounts Example

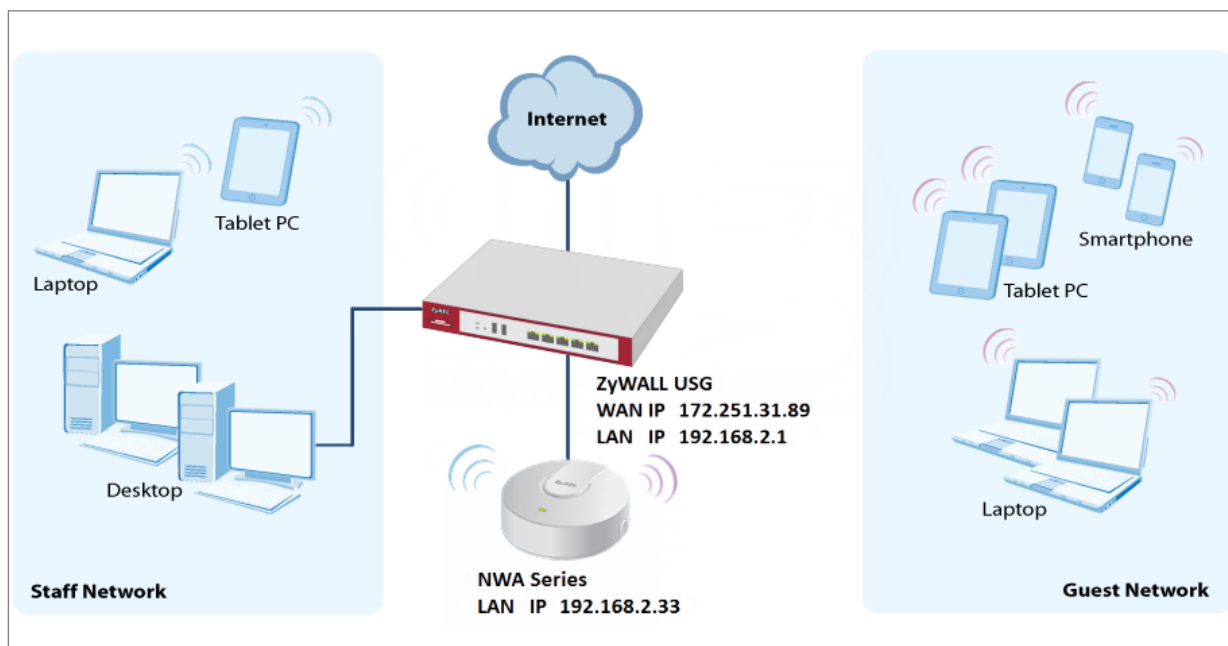

 Note: All network IP addresses and subnet masks are used as examples in this article. Please replace them with your actual network IP addresses and subnet masks. This example was tested using USG310 (Firmware Version: ZLD 4.25).

## Set Up the WiFi Guest Account, Address Range and Service

### Rule on the ZyWALL/USG

In the ZyWALL/USG, go to **CONFIGURATION > Object > User/Group > User > Add A User** to configure the **User Name** the guest Wi-Fi user and set **User Type** to **guest**. Set a secured **Password** (4-31 characters) and enter it again for confirmation.

Set the **Authentication Timeout Settings** to be **Use Manual Settings** to enter the number of minutes this user has to renew the current session before the user is logged out.

**CONFIGURATION > Object > User/Group > User > Add A User**

**User Configuration**

User Name : WiFi\_guest

User Type: user

Password: \*\*\*\*

Retype: \*\*\*\*

Description: Local User

Authentication Timeout Settings:  Use Default Settings  Use Manual Settings

Lease Time: 240 (0-1440 minutes, 0 is unlimited)

Reauthentication Time: 240 (0-1440 minutes, 0 is unlimited)

In the ZyWALL/USG, go to **CONFIGURATION > Object > Address > Add Address Rule** to create the guest Wi-Fi user access subnet. In this example, AP is connected to ZyWALL/USG LAN interface 192.168.2.0/24. Configure the **Name** for you to identify the Wi-Fi guest subnet. Set the **Network** to be 192.168.2.0 and set the **Netmask** to be 255.255.255.0. Click **OK**.

**CONFIGURATION > Object > Address > Add Address Rule**

**+ Add Address Rule**

Name: WiFi\_guest

Address Type: SUBNET

Network: 192.168.2.0

Netmask: 255.255.255.0

OK Cancel

In the ZyWALL/USG, go to **CONFIGURATION > Object > Service > Service Group >**

**Add Service Group Rule** to create the allowed protocols for guest Wi-Fi user. Configure the **Name** for you to identify the **Service Group**. Set **HTTP**, **HTTPS** and **DNS** to be in the same member group and click **OK**.

**CONFIGURATION > Object > Service > Service Group > Add Service Group Rule**

**Configuration**

Name:

Description:

**Configuration**

Available	Member
<p>=== Object ===</p> <ul style="list-style-type: none"> <li>AH</li> <li>AIM</li> <li>AUTH</li> <li>Any_TCP</li> <li>Any_UDP</li> <li>BGP</li> <li>BONJOUR</li> <li>BOOTP CLIENT</li> </ul>	<p>=== Object ===</p> <ul style="list-style-type: none"> <li>HTTP</li> <li>HTTPS</li> </ul> <p>=== Group ===</p> <ul style="list-style-type: none"> <li>DNS</li> </ul>

## Set Up the Web Authentication on the ZyWALL/USG

In the ZyWALL/USG, go to **CONFIGURATION > Web Authentication > Web Authentication Policy Summary > Auth. Policy Add** to configure policy to redirect HTTP traffic to the user login screen. Configure the **Description (Optional)** for you to identify the auth. Policy. Then, scroll down the **Source Address** list to choose the newly created **wifi-guest**. Set the **Authentication** to be **required**. Select **Force User Authentication**.

**CONFIGURATION > Web Authentication > Web Authentication Policy Summary > Auth. Policy Add**



**General Settings**

Enable Policy

Description:  (Optional)

---

**User Authentication Policy**

Incoming Interface:

Source Address:  SUBNET, 192.168.2.0/24

Destination Address:

Schedule:

Authentication:

Single Sign-on

Force User Authentication i

Authentication Type:

In the ZyWALL/USG, go to **CONFIGURATION > Web Authentication > General Settings** and select **Enable Web Authentication**.

**CONFIGURATION > Web Authentication > General Settings**

**Global Setting**

Enable Web Authentication

## Set Up the Security Policy on the ZyWALL/USG

In the ZyWALL/USG, go to **CONFIGURATION > Security Policy > Policy > Add corresponding**. Configure a **Name** for you to identify the **Security Policy** profile. Set **From: LAN** and **To: any (Excluding ZyWALL)**. Set **Service** to be the Service Group Rule (wifi\_guest\_access in this example). Set **User** to be the Wi-Fi guest user (wifi\_guest\_access in this example). Select Log type to **log alert** in order to view the result later.

**CONFIGURATION > Security Policy > Policy > Add corresponding**

<input checked="" type="checkbox"/> Enable		
Name:	WiFi_guest	
Description:		(Optional)
From:	any	
To:	any (Excluding ZyV	
Source:	any	
Destination:	any	
Service:	Wifi_guest_access	
User:	Wifi_guest	
Schedule:	none	
Action:	allow	
Log matched traffic:	log alert	

## Test the Result

Using a mobile device to connect to the AP which is connected to the ZyWALL/USG. When you try to access the Internet, it will redirect to the user login screen.

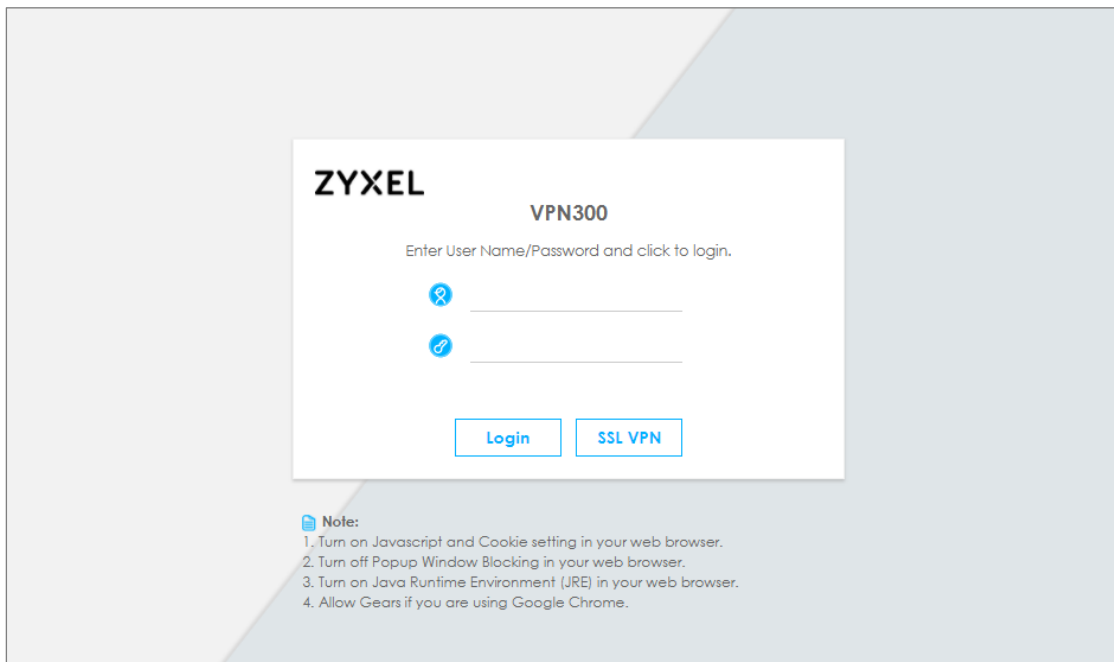

Type the Wi-Fi guest **User Name** and **Password**, click **Login**.

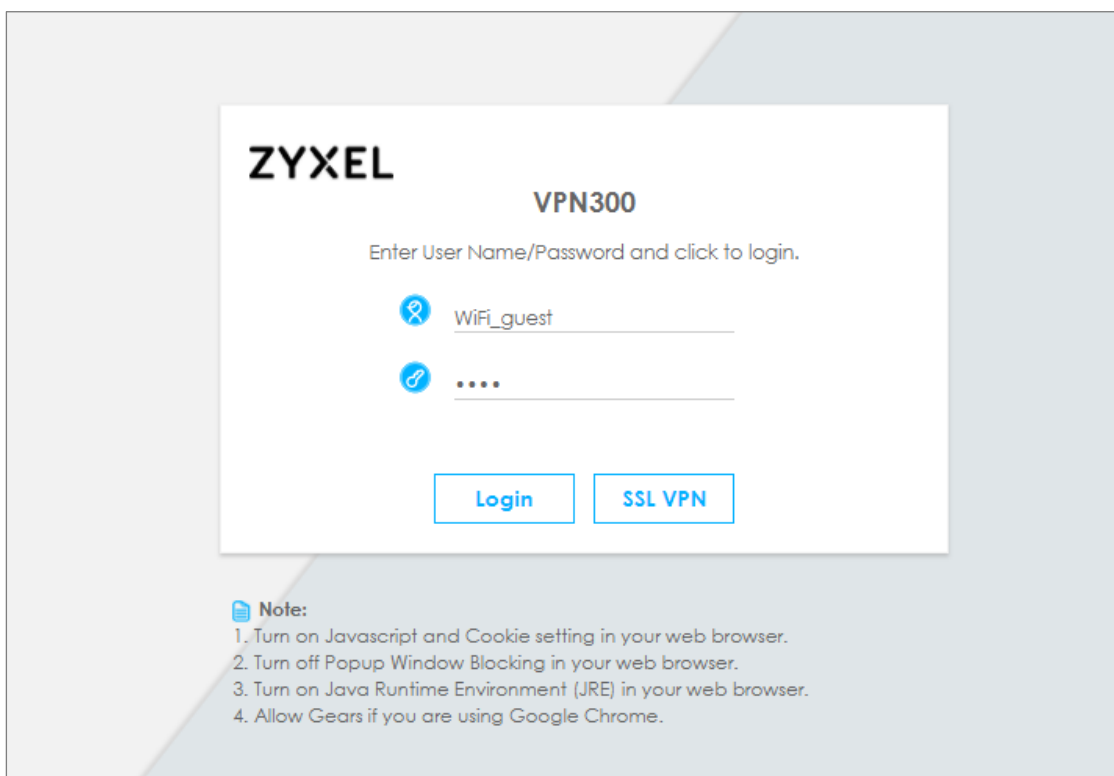

The access session page will appear.

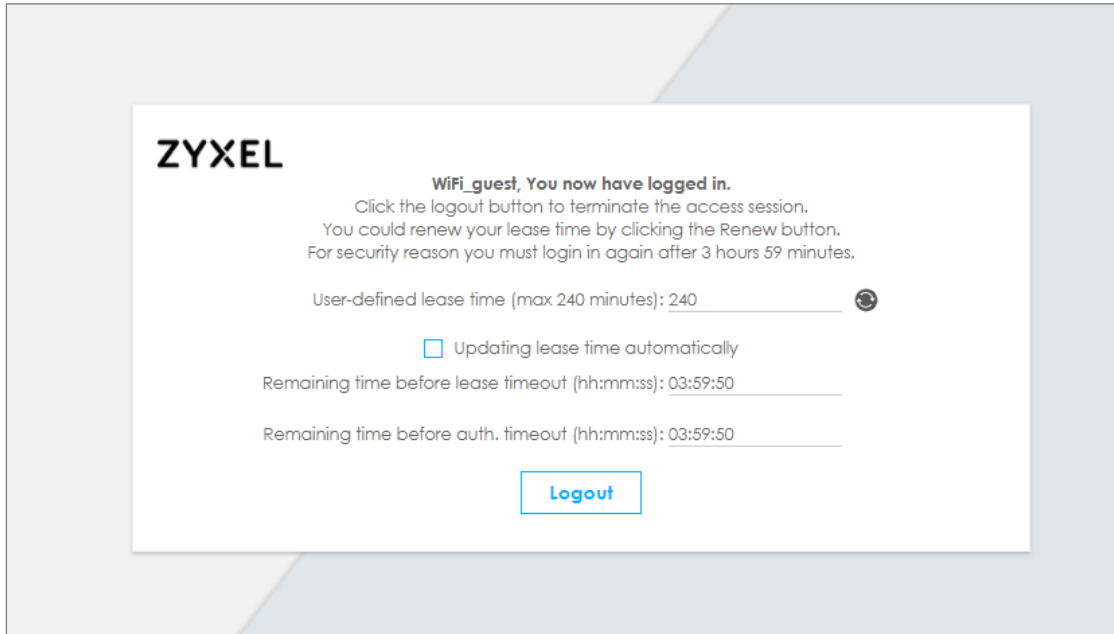

Go to the ZyWALL/USG **Monitor > System Status > Login Users**, you will see current login user list shown as below.

**Monitor > System Status > Login Users**

User ID	Reauth/Lease Time	Type	IP Address	MAC	User Info
wifi_guest	03:19:30 / 03:19:30	http/https	192.168.2.34	90:3C:92:1C:C5:8B	guest(wifi_guest)

#	User ID	Reauth/Lease Time	Type	IP Address	MAC	User Info
1	WiFi_guest	03:57:03 / 03:57:03	http/https	192.168.2.33	00:1E:33:28:4F:AE	guest(WiFi_guest)

Attempt to access FTP server (prohibited service in this example) and it gets an error message.

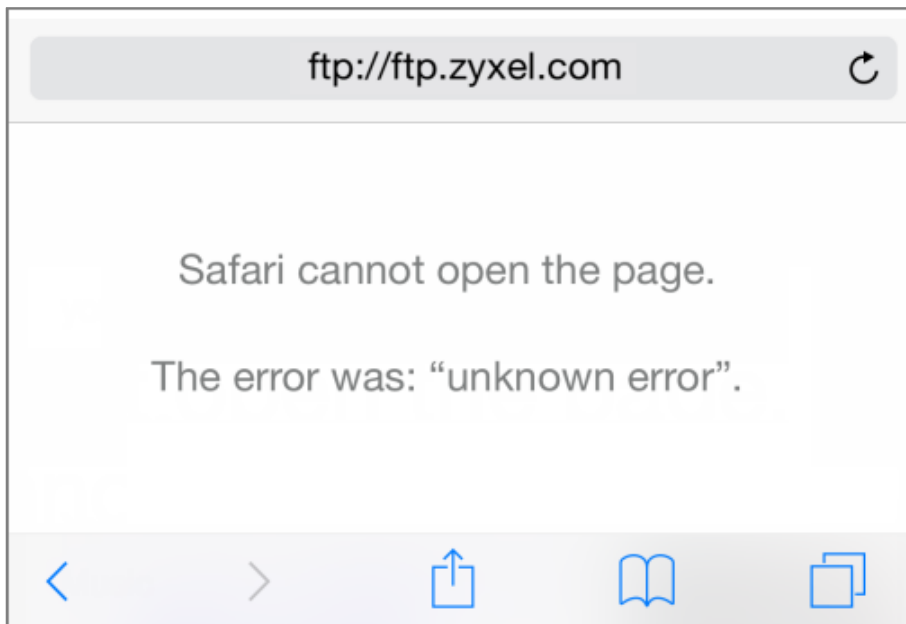

Go to the ZyWALL/USG **Monitor > Log**, you will see [notice] log message shown as below. The access to FTP service port 21 is blocked in this example.

### Monitor > Log

notice	Security Policy Control	Match default rule, DROP [count=2]	192.168.2.33:56799	36.226.188.36:21	ACCESS BLOCK
--------	-------------------------	------------------------------------	--------------------	------------------	--------------

## What Could Go Wrong?

If you see [notice] log shown as below, the Wi-Fi guest traffic is blocked by the **priority 1 Security Policy**. The ZyWALL/USG checks the security policy in order and applies the first security policy to the matched traffic. If the Wi-Fi guest traffic matches a policy that comes earlier in the list, it may be unexpectedly blocked. Please change your policy setting or move the Wi-Fi guest policy to the higher priority.

### Monitor > Log

Priority	Category	Message	Source	Destination	Note
notice	Security Policy Control	priority:1, from LAN to ANY, UDP, service Wifi_guest, REJECT	192.168.2.33:52555	172.25.5.210:53	ACCESS BLOCK
notice	Security Policy Control	priority:1, from LAN to ANY, TCP, service Wifi_guest, REJECT	192.168.2.33:59691	119.161.14.17:443	ACCESS BLOCK

 Note: The default setting of **Security Policy** is without log notification (except **PolicyDefault**), if you want to check which policy may potentially block the traffic, please select this policy and set the **Log matched traffic** to be **log** or **log alert**.

## How to create a Wi-Fi VLAN interfaces to separate staff network and Guest network

This example shows how to create Wi-Fi VLAN interfaces to separate staff network and Guest network. Suppose there should be no limitation for the staff network, but restrict the guests not access the USG.

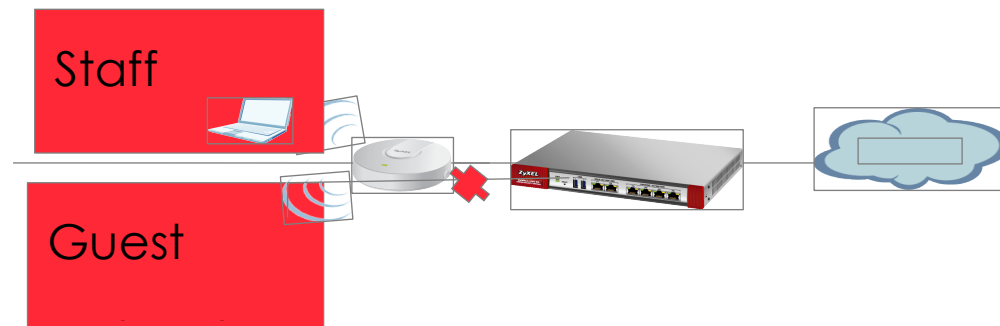

Separate the Staff and Guest network

 Note: All network IP addresses and subnet masks are used as examples in this article. Please replace them with your actual network IP addresses and subnet masks. This example was tested using USG210 (Firmware Version: ZLD 4.25)

## Set up Wi-Fi VLAN interfaces

### Create VLAN interfaces

Go to **CONFIGURATION > Object > Zone**. Create a zone for the guest.

**CONFIGURATION > Object > Zone**

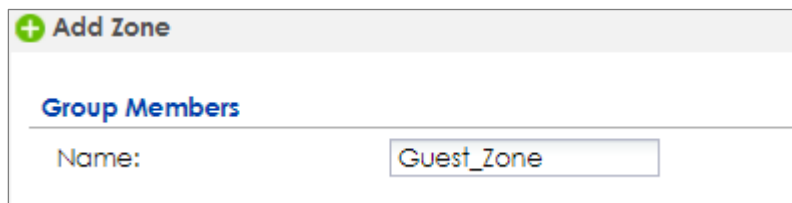

The screenshot shows a configuration window titled '+ Add Zone'. Below the title is a section labeled 'Group Members'. Under this section, there is a 'Name:' label followed by a text input field containing the text 'Guest\_Zone'.

Go to **CONFIGURATION > Network > Interface > VLAN**. Create VLAN16 for Staff\_WiFi and VLAN17 for Guest\_WiF

**CONFIGURATION > Network > Interface > VLAN > VLAN16**



**General Settings**

Enable Interface

**Interface Properties**

Interface Type:  ⓘ

Interface Name:

Zone:  ⓘ

Base Port:

VLAN ID:  (1-4094)

Advance

Description:  (Optional)

**IP Address Assignment**

IP Address:

Subnet Mask:

Enable IGMP Support

- IGMP Upstream
- IGMP Downstream

**DHCP Setting**

DHCP:

IP Pool Start Address:  Pool Size:

First DNS Server (Optional):

Second DNS Server (Optional):

Third DNS Server (Optional):

**CONFIGURATION > Network > Interface > VLAN > VLAN17**

**General Settings**

Enable Interface

**Interface Properties**

Interface Type:  ⓘ

Interface Name:

Zone:  ⓘ

Base Port:

VLAN ID:  (1-4094)

Advance

Description:  (Optional)

**IP Address Assignment**

IP Address:

Subnet Mask:

Enable IGMP Support

IGMP Upstream

IGMP Downstream

**DHCP Setting**

DHCP:

IP Pool Start Address:  Pool Size:

First DNS Server (Optional):

Second DNS Server (Optional):

Third DNS Server (Optional):

There will be two VLAN interfaces.

## CONFIGURATION > Network > Interface > VLAN

#	Status	Name	Port/VID	IP Address	Mask
1	🔆	vlan16	ge5/16	static --172.16.0.1	255.255.255.0
2	🔆	vlan17	ge6/17	static --172.17.0.1	255.255.255.0

Page 1 of 1 | Show 50 items | Displaying 1 - 2 of 2

### Set Up the User

Go to **Configuration > Object > User/Group > User**, and create users for the staff and the guest

#### Configuration > Object > User/Group > User > staff

+ Add A User ? X

**User Configuration**

User Name :

User Type:  ▾

Password:

Retype:

Description:

Authentication Timeout Settings  Use Default Settings  Use Manual Settings

Lease Time: 1440 minutes

Reauthentication Time: 1440 minutes

**Configuration > Object > User/Group > User > guest**

+ Add A User ? X

**User Configuration**

User Name :

User Type:  ▾

Password:

Retype:

Description:

Authentication Timeout Settings  Use Default Settings  Use Manual Settings

Lease Time: 1440 minutes

Reauthentication Time: 1440 minutes

There will be two users.

User	Group	Setting	MAC Address	
<b>Configuration</b>				
<span style="color: green;">+</span> Add <span style="color: orange;">✎</span> Edit <span style="color: red;">✖</span> Remove <span style="color: blue;">🔗</span> Object References				
#	User Name	User Type	Description	Reference
1	admin	admin	Administration account	0
2	ldap-users	ext-user	External LDAP Users	0
3	radius-users	ext-user	External RADIUS Users	0
4	ad-users	ext-user	External AD Users	0
5	WiFi_guest	guest	Local User	1
6	staff	user	Local User	0
7	guest	user	Local User	0

⏪ Page 1 of 1 ▶▶ Show 50 items Displaying 1 - 7 of 7

## Set Up the AP Profile

Go to **CONFIGURATION > Object > AP Profile > SSID > Security List**, and create two security profiles.

### CONFIGURATION > Object > AP Profile > SSID > Security List > Guest\_WPA2

<b>General Settings</b>	
Profile Name:	<input type="text" value="Guest_WPA2"/>
Security Mode:	<input type="text" value="wpa2"/>
<b>Fast Roaming Settings</b>	
<input type="checkbox"/> 802.11r	
<b>Radius Settings</b>	
Radius Server Type:	<input type="text" value="Internal"/>
<input type="checkbox"/> Proxy by controller directly	
<b>MAC Authentication Setting</b>	
<input type="checkbox"/> MAC Authentication	
Auth. Method:	<input type="text" value="default"/>
Delimiter (Account):	<input <="" td="" type="text" value="colon (:)"/>
Case (Account):	<input type="text" value="upper"/>
Delimiter (Calling Station ID):	<input <="" td="" type="text" value="colon (:)"/>
Case (Calling Station ID):	<input type="text" value="upper"/>

<b>Authentication Settings</b>	
<input type="radio"/> 802.1X	
Auth. Method:	<input type="text" value="default"/>
ReAuthentication Timer:	<input type="text" value="0"/> (30~30000 seconds, 0 is unlimited)
<input checked="" type="radio"/> PSK	
Pre-Shared Key:	<input type="text" value="12345678"/>
Cipher Type:	<input type="text" value="auto"/>
Idle timeout:	<input type="text" value="300"/> (30~30000 seconds)
Group Key Update Timer:	<input type="text" value="30000"/> (30~30000 seconds)
<input type="checkbox"/> Management Frame Protection <input checked="" type="radio"/> Optional <input type="radio"/> Required	

### CONFIGURATION > Object > AP Profile > SSID > Security List > Staff\_WPA2

<b>General Settings</b>	
Profile Name:	<input type="text" value="Staff_WPA2"/>
Security Mode:	<input type="text" value="wpa2"/>
<b>Fast Roaming Settings</b>	
<input type="checkbox"/> 802.11r	
<b>Radius Settings</b>	
Radius Server Type:	<input type="text" value="Internal"/>
<input type="checkbox"/> Proxy by controller directly	
<b>MAC Authentication Setting</b>	
<input type="checkbox"/> MAC Authentication	
Auth. Method:	<input type="text" value="default"/>
Delimiter (Account):	<input <="" td="" type="text" value="colon (:)"/>
Case (Account):	<input type="text" value="upper"/>
Delimiter (Calling Station ID):	<input <="" td="" type="text" value="colon (:)"/>
Case (Calling Station ID):	<input type="text" value="upper"/>

<b>Authentication Settings</b>	
<input type="radio"/> 802.1X	
Auth. Method:	<input type="text" value="default"/>
ReAuthentication Timer:	<input type="text" value="0"/> (30~30000 seconds, 0 is unlimited)
<input checked="" type="radio"/> PSK	
Pre-Shared Key:	<input type="text" value="12345678"/>
Cipher Type:	<input type="text" value="auto"/>
Idle timeout:	<input type="text" value="300"/> (30-30000 seconds)
Group Key Update Timer:	<input type="text" value="30000"/> (30-30000 seconds)
<input type="checkbox"/> Management Frame Protection <input checked="" type="radio"/> Optional <input type="radio"/> Required	

Go to **CONFIGURATION > Object > AP Profile > SSID > SSID List**, and create two SSID profiles.

**CONFIGURATION > Object > AP Profile > SSID > SSID List > Staff\_Wifi**

**+ Add SSID Profile** ? ✕

Create new Object ▾

Profile Name:

SSID:

Security Profile:  ▾

MAC Filtering Profile:  ▾

QoS:  ▾

Rate Limiting (Per Station Traffic Rate) ⓘ

Downlink:   ▾ (0~160, 0 is unlimited)

Uplink:   ▾ (0~160, 0 is unlimited)

Band Select:  ▾

Forwarding Mode:  ▾

VLAN ID:  (1~4094)

Hidden SSID

Enable Intra-BSS Traffic blocking

Schedule SSID ⓘ

**OK** **Cancel**

**CONFIGURATION > Object > AP Profile > SSID > SSID List > Guest\_Wifi**

+ Add SSID Profile
? X

+ Create new Object ▼

Profile Name:

SSID:

Security Profile:  ▼

MAC Filtering Profile:  ▼

QoS:  ▼

Rate Limiting (Per Station Traffic Rate) ⓘ

Downlink:   ▼ (0~160, 0 is unlimited)

Uplink:   ▼ (0~160, 0 is unlimited)

Band Select:  ▼

Forwarding Mode:  ▼

VLAN ID:  (1~4094)

Hidden SSID

Enable Intra-BSS Traffic blocking

Schedule SSID ⓘ

Go to **CONFIGURATION > Wireless > AP Management > AP Group**, and add an AP Group as **WiFi**.

**CONFIGURATION > Wireless > AP Management > AP Group**

**Add AP Group Profile**

**General Settings**

Group Name:

Description:  (Optional)

**Radio 1 Setting**

OP Mode:  AP Mode  MON Mode  Root AP  Repeater AP

Radio 1 AP Profile:

Output Power:  dBm (0~30)

#	SSID Profile
1	Staff_wifi
2	Guest_wifi
3	disable
4	disable
5	disable
6	disable
7	disable
8	disable

Go to **CONFIGURATION > Wireless > AP Management > Mgnt. AP List**, and Edit the AP List. Change the Group setting as **WiFi**

**CONFIGURATION > Wireless > AP Management > Mgnt. AP List,**

**Edit AP List**

Create new Object

**Configuration**

MAC: 40:4A:03:69:A5:04

Model: NWA5160N

Description:

Group Setting:

**Radio1 Setting**

Override Group Radio Setting

OP Mode:  AP Mode  MON Mode

Radio 1 Profile:

**Set Up the Security policy rule**



Go to **CONFIGURATION > Security Policy > Policy Control > Policy**. Add one rule to restrict Guest access USG, and another one to allow to access internet.

**CONFIGURATION > Security Policy > Policy Control > Policy > Guest\_ZyWALL**

**+ Add corresponding** [?] [X]

Create new Object ▾

Enable

Name:

Description:  (Optional)

From:  ▾

To:  ▾

Source:  ▾

Destination:  ▾

Service:  ▾

User:  ▾

Schedule:  ▾

Action:  ▾

Log denied traffic:  ▾

OK Cancel

**CONFIGURATION > Security Policy > Policy Control > Policy > Guest\_Internet**

**+ Add corresponding** ? ✕

Create new Object ▼

Enable

Name:

Description:  (Optional)

From:  ▼

To:  ▼

Source:  ▼

Destination:  ▼

Service:  ▼

User:  ▼

Schedule:  ▼

Action:  ▼

Log denied traffic:  ▼

**OK** **Cancel**

## Test result

Connect to the SSID Staff\_WiFi, and ping the USG interface.

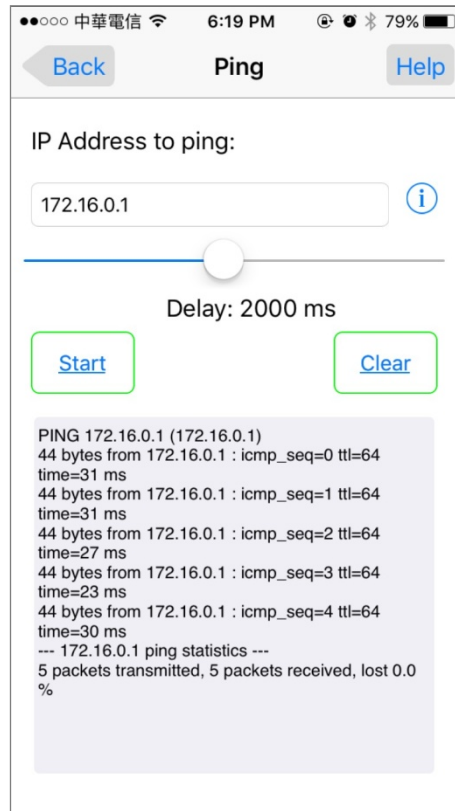
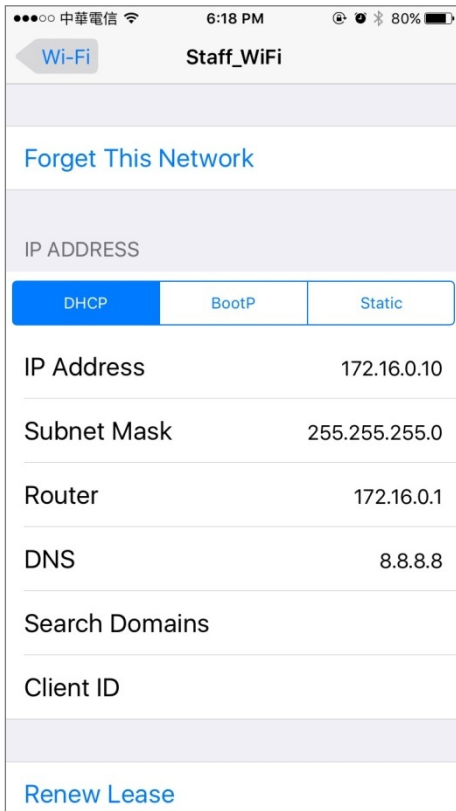

Connect to the SSID Guest\_WiFi, and ping the USG interface

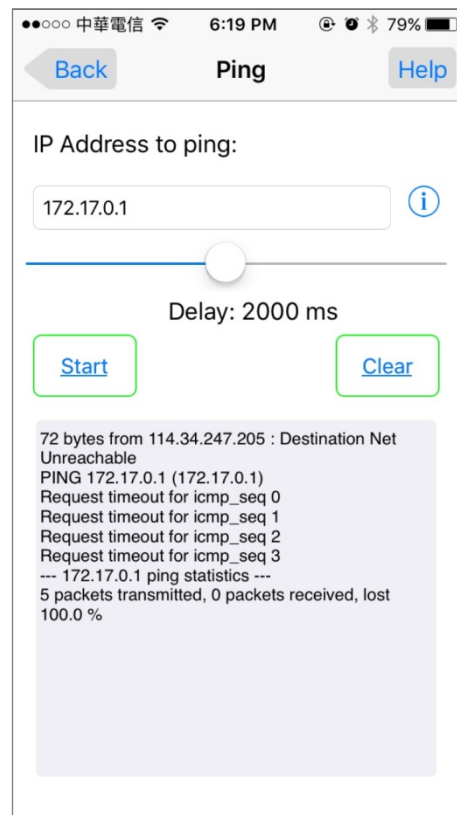
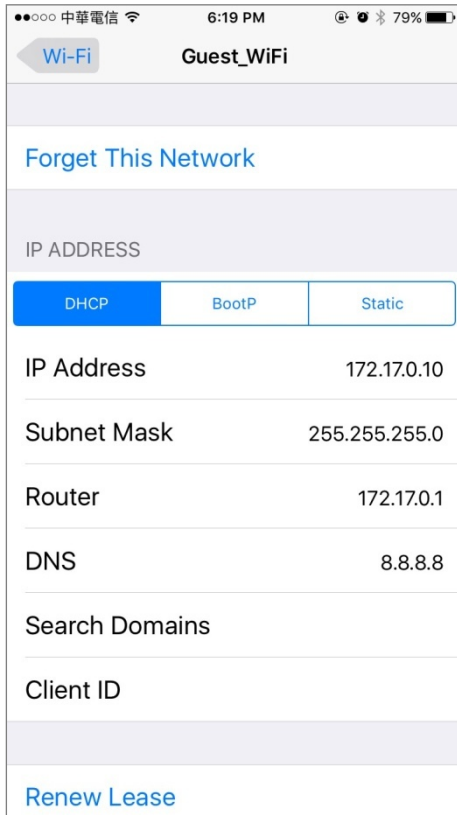

## What could go wrong

Choose the wrong zone for the Guest VLAN interface.

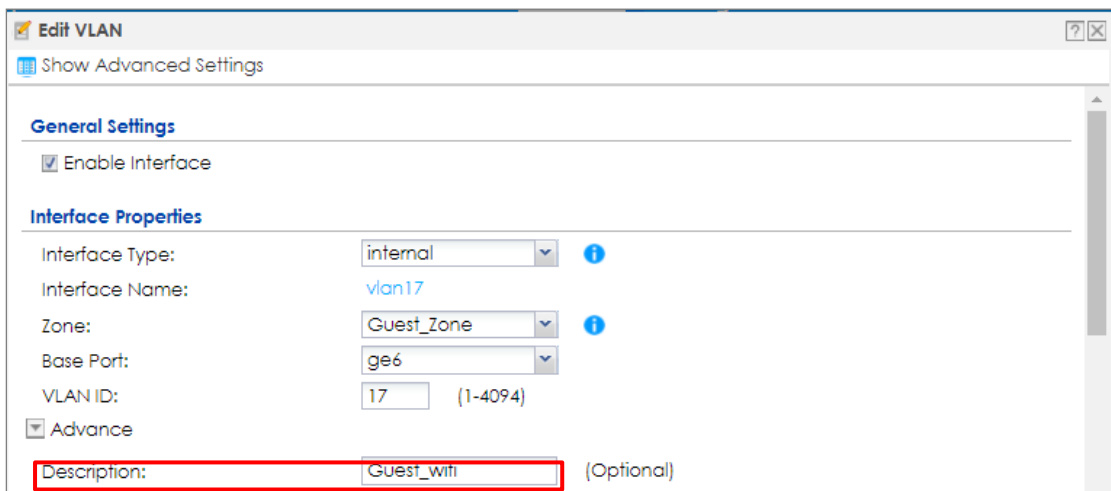

Not change the AP to the correct group

**Edit AP List**

Create new Object ▾

---

**Configuration**

MAC: 58:8B:F3:91:6B:C7

Model: NWA5123-AC

Description: AP-588BF3916BC7

Group setting: WiFi ▾

**Policy**

Show Filter

---

**General Settings**

Enable Policy Control

---

**IPv4 Configuration**

Allow Asymmetrical Route

+ Add Edit Remove Activate Inactivate Move Clone

Pri...	St...	Name	From	To	IPv4 Sou...	IPv4 Des...	Service	User	Schedule	Action	Log	UTM Profile
1		Guest_Internet	Guest_...	any (Exc...	any	any	any	any	none	allow	no	
2		Guest_ZyWALL	Guest_...	ZyWALL	any	any	any	any	none	deny	no	

## How to Set Up WiFi Networks with Microsoft Active Directory Authentication

This is an example of using ZyWALL/USG to configure guest WiFi accounts with Microsoft Active Directory (AD) to authenticate your WiFi guests. For the wireless network setup, please go to [How to Set Up WiFi with ZyXEL AP](#).

ZyWALL/USG with AD Guest WiFi Accounts Example

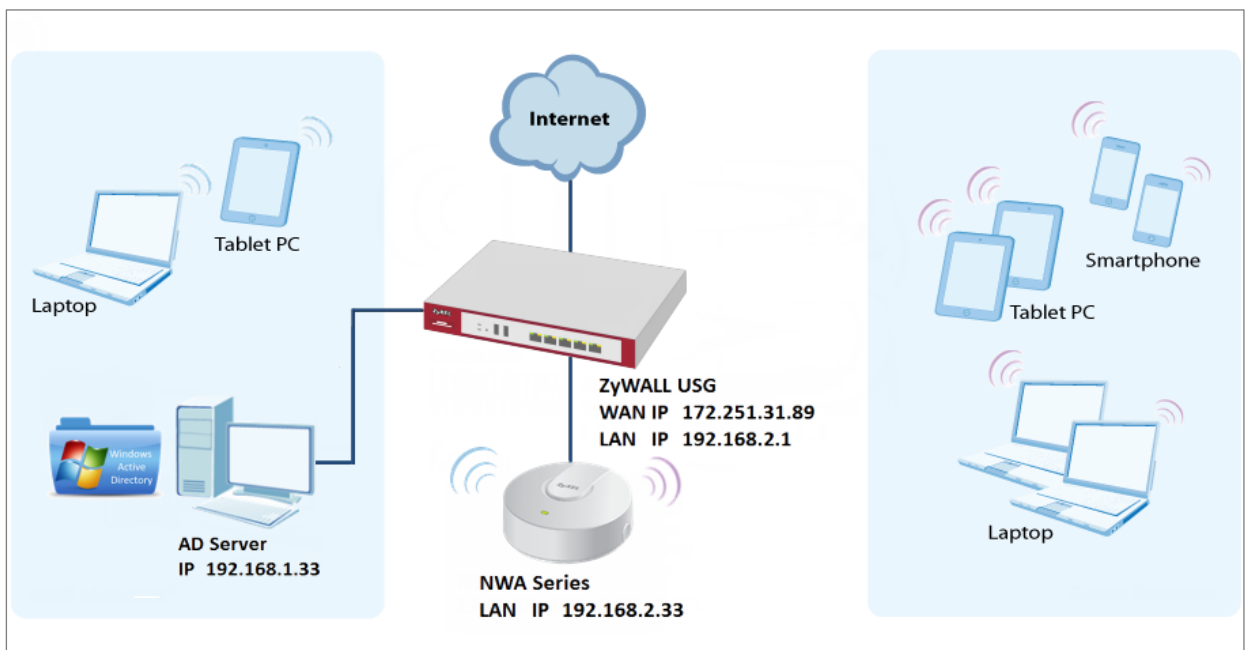

 Note: All network IP addresses and subnet masks are used as examples in this article. Please replace them with your actual network IP addresses and subnet masks. This example was tested using USG310 (Firmware Version: ZLD 4.25).

## Set Up the Wi-Fi Guest Account and Authentication Method on the ZyWALL/USG

In the ZyWALL/USG, go to **CONFIGURATION > Object > User/Group > User > ad-users**, set the **Authentication Timeout Settings** to **Use Manual Settings** and enter the number of minutes this user has to renew the current session before the user is logged out.

**CONFIGURATION > Object > User/Group > User > ad-users**

**Edit User ad-users**

**User Configuration**

User Name : ad-users

User Type: ext-user

Description: External AD Users

Authentication Timeout Settings:  Use Default Settings  Use Manual Settings

Lease Time: 1440 minutes

Reauthentication Time: 1440 minutes

In the ZyWALL/USG, go to **CONFIGURATION > Object > Authentication Method > default > Edit Authentication Method default**, click **Add** to insert group ad in the table. Click **OK**.

**CONFIGURATION > Object > User/Group > User > ad-users**

**Edit Authentication Method default**

**General Settings**

Name: default

+ Add Edit Remove Move

#	Method List
1	group ad

OK Cancel

In the ZyWALL/USG, go to **CONFIGURATION > Web Authentication > General Settings** and select **Enable Web Authentication**.

**CONFIGURATION > Web Authentication > General Settings**

Global Setting	
<input checked="" type="checkbox"/>	Enable Web Authentication

## Set Up the Active Directory Server Account on the ZyWALL/USG

In the ZyWALL/USG, go to **CONFIGURATION > Object > AAA Server > Active Directory > Add Active Directory** to configure the AD sever. Enter the **Server Address** (192.168.1.33 in this example) and **Based DN** (dc=cso,dc=net in this example). Specify the **Bind DN** for logging into the AD server (cn=Administrator,cn=users,dc=cso,dc=net in this example). If required, enter the **Password** for the ZyWALL/USG to bind (or log in) to the AD server.

**CONFIGURATION > Object > AAA Server > Active Directory > Add Active Directory**

General Settings		
Name:	ad	
Description:	<input type="text"/>	(Optional)
Server Settings		
Server Address:	<input type="text" value="192.168.1.33"/>	(IP or FQDN)
Backup Server Address:	<input type="text"/>	(IP or FQDN) (Optional)
Port:	<input type="text" value="389"/>	(1-65535)
Base DN:	<input type="text" value="dc=cso,dc=net"/>	
<input type="checkbox"/> Use SSL		
Search time limit:	<input type="text" value="5"/>	(1-300 seconds)
<input type="checkbox"/> Case-sensitive User Names		
Server Authentication		
Bind DN:	<input type="text" value="cn=administrator,cn=users,dc=cso,dc=net"/>	
Password:	<input type="password" value="••••"/>	
Retype to Confirm:	<input type="password" value="••••"/>	

Scroll down to the **Configuration Validation** section, use a user account from the server specified above to test if the configuration is correct. Enter the account's



user name (wifi\_guest in this example) in the **Username** field and click **Test**. A pop-up screen will appear allowing you to view the test result. Click **OK** to save the configuration.

**CONFIGURATION > Object > AAA Server > Active Directory > Add Active Directory**

**Configuration Validation**

Please enter an existing user account in this server to validate the above settings.

Username:

**Test Status:**

OK

**Returned User Attributes:**

```
dn: CN=wifi_guest,CN=Users,DC=cso,DC=net
objectClass: top
objectClass: person
objectClass: organizationalPerson
objectClass: user
cn: wifi_guest
givenName: wifi_guest
distinguishedName: CN=wifi_guest,CN=Users,DC=cso,DC=net
```

## Set Up the Security Policy on the ZyWALL/USG

In the ZyWALL/USG, go to **CONFIGURATION > Security Policy > Policy > Add corresponding**. Configure a **Name** for you to identify the **Security Policy** profile. Set **From: LAN** and **To: any (Excluding ZyWALL)**. Set **Service** to be the service rule for Wi-Fi guest (wifi\_guest\_access in this example). Set **User** to be the Wi-Fi guest user (ad-users in this example). Select Log type to be **log alert** in order to view the result later.

**CONFIGURATION > Security Policy > Policy > Add corresponding**

<input checked="" type="checkbox"/> Enable		
Name:	WiFi_Guest	
Description:		(Optional)
From:	LAN	
To:	any (Excluding ZyV	
Source:	any	
Destination:	any	
Service:	Wifi_guest_access	
User:	ad-users	
Schedule:	none	
Action:	allow	
Log matched traffic:	log alert	

## Test the Result

Using a mobile device to connect to the AP which is connected to the ZyWALL/USG. When you try to access the Internet, it will redirect to the user login screen.

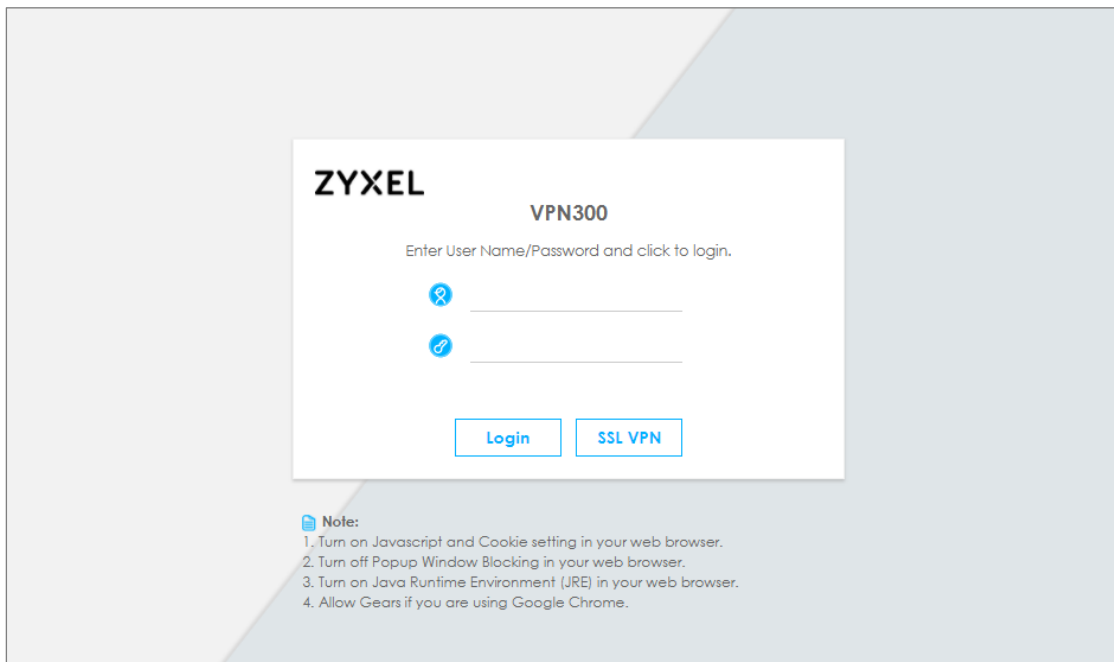

Type the Wi-Fi guest **User Name** and **Password**, click **Login**.

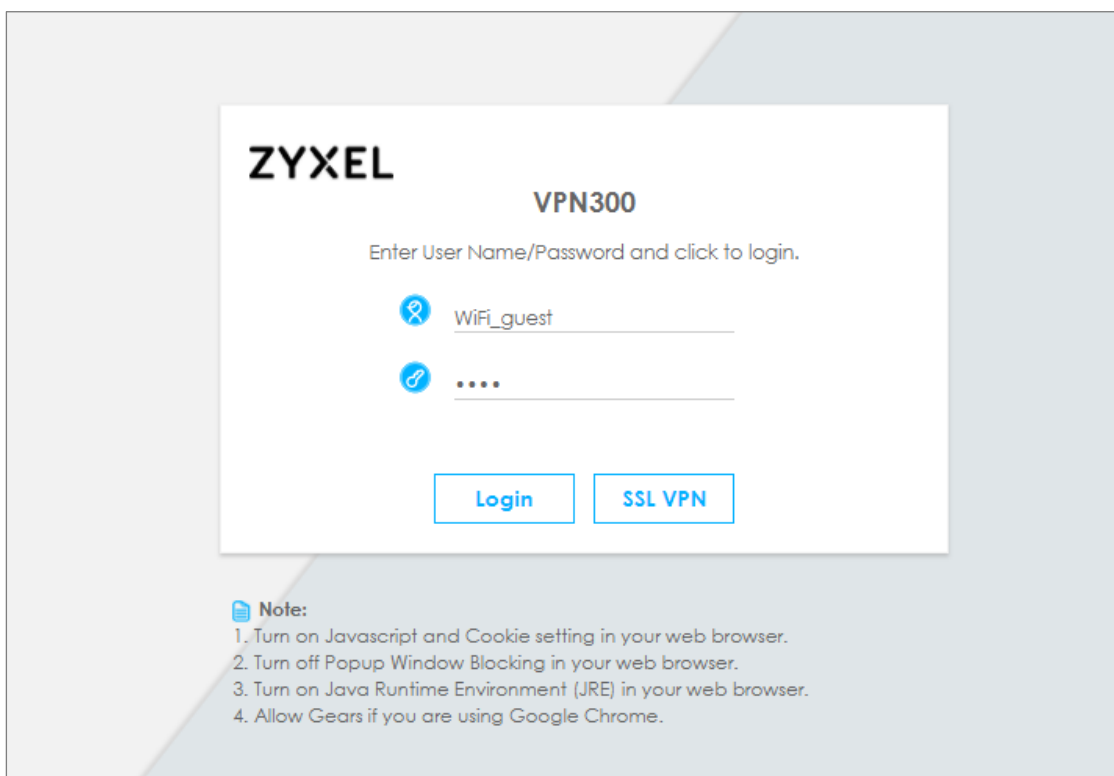

The access session page will appear.

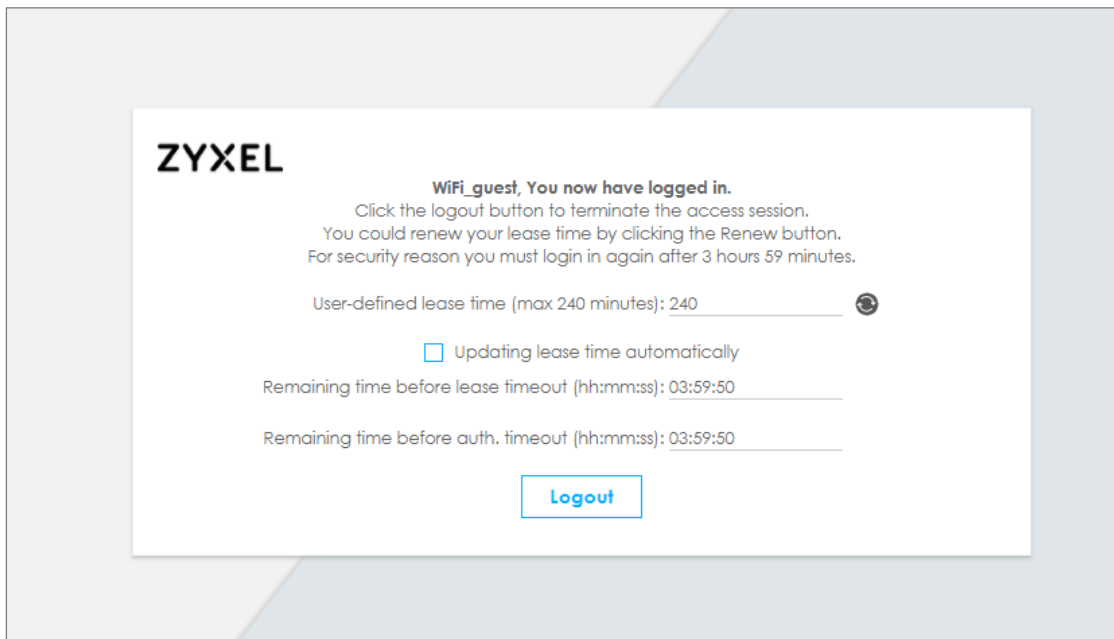

Go to the ZyWALL/USG **Monitor > System Status > Login Users**, you will see current login user list as below.

**Monitor > System Status > Login Users**

User ID	Reauth/Lease Time	Type	IP Address	MAC	User Info
WIFI_GUEST	03:59:42 / 03:59:42	http/https	192.168.2.34	90:3C:92:1C:C5:8B	ext-user(ad-users)

## What Could Go Wrong?

If you see [notice] log shown as below, the Wi-Fi guest traffic is blocked by the **priority 1 Security Policy**. The ZyWALL/USG checks the security policy in order and applies the first security policy the traffic matches. If the Wi-Fi guest traffic matches a policy that comes earlier in the list, it may be unexpectedly blocked. Please change your policy setting or move the Wi-Fi guest policy to the higher priority.

**Monitor > Log**

Priority	Category	Message	Note
notice	Security Policy Control	priority:1, from LAN to ANY, TCP, service HTTPS, REJECT [count=3]	ACCESS BLOCK
notice	Security Policy Control	priority:1, from LAN to ANY, TCP, service HTTPS, REJECT [count=3]	ACCESS BLOCK

If you see [alert] log message shown as below, the Wi-Fi guest traffic failed. Please make sure you enable **Web Authentication** and check your AD server is working properly.

### Monitor > Log

Priority	Category	Message	Note
alert	User	Failed login attempt to Device from http/https (incorrect passw...	Account: wifi_guest

 Note: The default setting of **Security Policy** is without log notification (except **PolicyDefault**), if you want to check which policy may potentially block the traffic, please select this policy and set the **Log matched traffic** to be **log** or **log alert**.

## How to Set Up IPv6 Interfaces for Pure IPv6 Routing

This example shows how to configure your ZyWALL/USG WAN and LAN interfaces which connects two IPv6 networks. ZyWALL/USG periodically advertises a network prefix of 2002:1111:1111:1111::/64 to the LAN through router advertisements.

ZyWALL/USG with Pure IPv6 Network Example

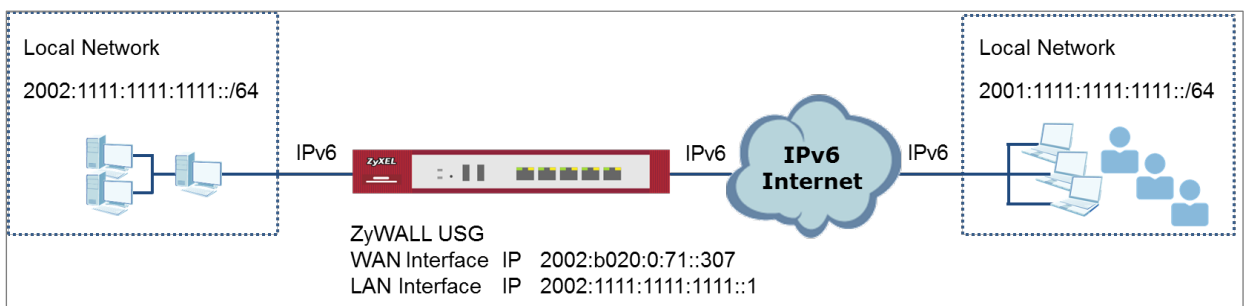

 Note: All network IP addresses and subnet masks are used as examples in this article. Please replace them with your actual network IP addresses and subnet masks. This example was tested using USG310 (Firmware Version: ZLD 4.25).

## Enable the IPv6 on the ZyWALL/USG

In the ZyWALL/USG, go to **CONFIGURATION > System > IPv6 > Global Setting**, select the **Enable IPv6** and click **Apply** at the bottom of the screen.

**CONFIGURATION > System > IPv6 > Global Setting**

Global Setting
<input checked="" type="checkbox"/> Enable IPv6

## Set Up the WAN IPv6 Interface on the ZyWALL/USG

In the ZyWALL/USG, go to **CONFIGURATION > Network > Interface > Ethernet > wan1**. Select **Enable Interface** and **Enable IPv6**. Select **Enable Stateless Address Auto-configuration (SLAAC)**. Click **OK**.

**CONFIGURATION > Network > Interface > Ethernet > wan1**

General Settings	
<input checked="" type="checkbox"/> Enable Interface	
General IPv6 Setting	
<input checked="" type="checkbox"/> Enable IPv6	<span>?</span>
Interface Properties	
Interface Type:	external <span>?</span>
Interface Name:	ge1
Port:	P1
Zone:	WAN <span>?</span>
MAC Address:	B8:EC:A3:A9:C0:0B
Description:	<input type="text"/> (Optional)
IPv6 Address Assignment	
<input checked="" type="checkbox"/> Enable Stateless Address Auto-configuration (SLAAC)	
Link-Local Address:	n/a
IPv6 Address/Prefix Length:	<input type="text"/> (Optional)

 Note: Your ISP or uplink router should enable router advertisement.

## Set Up the LAN IPv6 Interface on the ZyWALL/USG

In the ZyWALL/USG, go to **CONFIGURATION > Network > Interface > Ethernet > lan1**. Select **Enable Interface** and **Enable IPv6**. Select **Enable Stateless Address Auto-configuration (SLAAC)**. Select **Enable Router Advertisement** and click **Add** to configure a network prefix for the LAN1 (2002:1111:1111:1111::/64 in this example).

Click **OK**.

**CONFIGURATION > Network > Interface > Ethernet > lan1 > General Settings**

General Settings	
<input checked="" type="checkbox"/> Enable Interface	
General IPv6 Setting	
<input checked="" type="checkbox"/> Enable IPv6	<span>?</span>
Interface Properties	
Interface Type:	internal <span>?</span>
Interface Name:	Lan1
Port:	P5, P6
Zone:	LAN1 <span>?</span>
MAC Address:	B8:EC:A3:A9:C0:0F
Description:	<input type="text"/> (Optional)

**CONFIGURATION > Network > Interface > Ethernet > lan1 > IPv6 Router**

**Advertisement Setting**

IPv6 Router Advertisement Setting					
<input checked="" type="checkbox"/> Enable Router Advertisement					
<input type="checkbox"/> Advance					
Router Preference:	Medium				
<input type="checkbox"/> Advance					
Advertised Prefix Table	<div style="border: 1px solid #ccc; padding: 5px;"><div style="display: flex; justify-content: space-between; align-items: center;"><span><span style="color: green;">+</span> Add</span> <span><span style="color: blue;">✎</span> Edit</span> <span><span style="color: red;">✖</span> Remove</span></div><table border="1" style="width: 100%;"><thead><tr><th>#</th><th>IPv6 Address/Prefix Length</th></tr></thead><tbody><tr><td>1</td><td>2001:1111:1111:1111::/64</td></tr></tbody></table><div style="display: flex; justify-content: space-between; align-items: center;"><span>Page 1 of 1</span> <span>Show 50 items</span> <span>Displaying 1 -</span></div></div>	#	IPv6 Address/Prefix Length	1	2001:1111:1111:1111::/64
#	IPv6 Address/Prefix Length				
1	2001:1111:1111:1111::/64				

## Test the Result

Connect a computer to the ZyWALL/USG's LAN1.



Enable IPv6 support on your computer. In Windows XP, you need to use the IPv6 install command in a Command Prompt. In Windows 7, IPv6 is supported by default. You can enable IPv6 in the **Control Panel > Network and Sharing Center > Local Area Connection** screen

Your computer should get an IPv6 IP address (starting with 2002:1111:1111:1111: for this example) from the ZyWALL/USG.

**Window 7 > cmd > ipconfig**

```
C:\Windows\system32>ipconfig

Windows IP Configuration

Ethernet adapter Local Area Connection:

    Connection-specific DNS Suffix . : localdomain
    IPv6 Address. . . . . : 2002:1111:1111:1111:dc9:e2ff:7d32:19c9
    Temporary IPv6 Address. . . . . : 2002:1111:1111:1111:444d:9168:b972:2720
    Link-local IPv6 Address . . . . . : fe80::dc9:e2ff:7d32:19c9%12
    Default Gateway . . . . . : fe80::b2b2:dcff:fe70:c1d8%12
```

Open a web browser and type <http://test-ipv6.com/>. You can see the IPv6 connectivity result shown as below:

The screenshot shows a web browser window at [test-ipv6.com](http://test-ipv6.com/). The page has a navigation bar with 'Test IPv6', 'FAQ', 'Mirrors', and 'stats'. The main heading is 'Test your IPv6 connectivity.' Below this is a sub-navigation bar with 'Summary', 'Tests Run', 'Share Results / Contact', 'Other IPv6 Sites', and 'For the Help Desk'. The main content area displays several status messages:

- Your IPv6 address on the public Internet appears to be 2002:b020:0:71::307
- Your Internet Service Provider (ISP) appears to be HINET Data Communication Business Group, TW
- Since you have IPv6, we are including a tab that shows how well you can reach other IPv6 sites. [\[more info\]](#)
- Good news!** Your current configuration will continue to work as web sites enable IPv6.
- Your DNS server (possibly run by your ISP) appears to have IPv6 Internet access.

A large black bar highlights the 'Your readiness score' section, which shows a score of **10/10** for your IPv6 stability and readiness, when publishers are forced to go IPv6 only. Below the score is a link to 'test data' and a note '(Updated server side IPv6 readiness stats)'.

## What Could Go Wrong?

If your IPv6 connection is not working, please make sure you enable Auto-Configuration on the WAN1 IPv6 interface. If not, you will not have any default route to forward the LAN's IPv6 packets.

In Windows, some IPv6 related tunnels may be enabled by default such as Teredo and 6to4 tunnels. It may cause your computer to handle IPv6 packets in an unexpected way. It is recommended to disable those tunnels on your computer.

## How to Set Up an IPv6 6to4 Tunnel

This example shows how to configure your ZyWALL/USG to create IPv6 6to4 Tunnel. In this example, the ZyWALL/USG acts as a 6to4 router which connects the IPv4. After configuration, the ZyWALL/USG can assign an IPv6 to clients behind it and pass IPv6 traffic through IPv4 environment to access remote IPv6 network.

ZyWALL/USG with IPv6 6to4 Tunnel Example

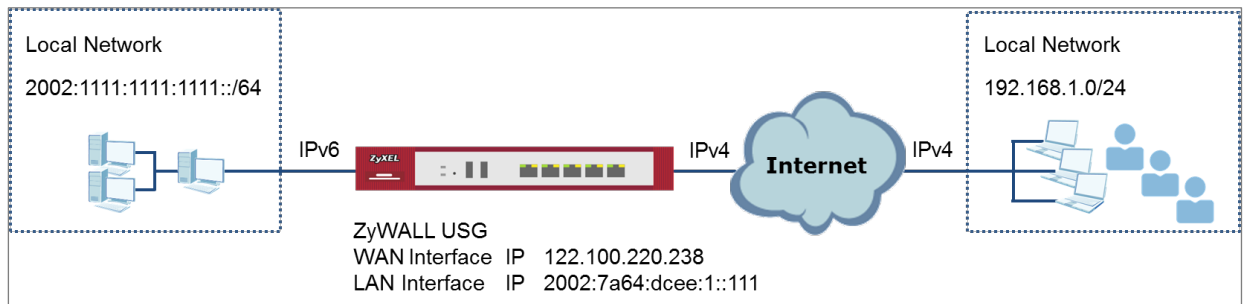

 Note: All network IP addresses and subnet masks are used as examples in this article. Please replace them with your actual network IP addresses and subnet masks. This example was tested using USG310 (Firmware Version: ZLD 4.25).

## Set Up the LAN IPv6 Interface on the ZyWALL/USG

The second and third sets of 16-bit IP address from the left must be converted from wan1 IP (122.100.220.238 in this example). It becomes 7a64:dcee in hexadecimal. (You can go to <https://isc.sans.edu/tools/ipv6.html#form> to convert an IPv4 address into its default 6-to-4 equivalent). You are free to use the fourth set of 16-bit IP address from the left in order to allocate different network addresses (prefixes) to IPv6 interfaces. In this example, the LAN1 network address is assigned to use 2002:7a64:dcee:1::/64 and the LAN1 IP address is set to

2002:7a64:dcee:1::111/128.

In the ZyWALL/USG, go to **CONFIGURATION > Network > Interface > Ethernet > lan1**, Select **Enable Interface** and **Enable IPv6**. Type 2002:7a64:dcee:1::111/128 in the **IPv6 Address/Prefix Length** field for the LAN1's IP address.

Enable **Router Advertisement**. Then click **Add** in the **Advertised Prefix Table** to add **2002:7a64:dcee:1::/64**. The LAN1 hosts will get the network prefix through the router advertisement messages sent by the LAN1 IPv6 interface periodically. Click **OK**.

**CONFIGURATION > Network > Interface > Ethernet > lan1 > General Settings**

General Settings	
<input checked="" type="checkbox"/> Enable Interface	
General IPv6 Setting	
<input checked="" type="checkbox"/> Enable IPv6	<span>?</span>
Interface Properties	
Interface Type:	internal <span>?</span>
Interface Name:	Lan1
Port:	P5, P6
Zone:	LAN1 <span>?</span>
MAC Address:	B8:EC:A3:A9:C0:0F
Description:	<input type="text"/> (Optional)
IPv6 Address Assignment	
<input type="checkbox"/> Enable Stateless Address Auto-configuration (SLAAC)	
Link-Local Address:	fe80::baec:a3ff:fea9:c00f/64
IPv6 Address/Prefix Length:	2002:7a64:dcee::111, (Optional)

**CONFIGURATION > Network > Interface > Ethernet > lan1 > IPv6 Router**

**Advertisement Setting**

IPv6 Router Advertisement Setting					
<input checked="" type="checkbox"/> Enable Router Advertisement					
<input type="checkbox"/> Advance					
Router Preference:	Medium				
<input type="checkbox"/> Advance					
Advertised Prefix Table	<div style="display: flex; align-items: center; gap: 5px;"> <span style="color: green;">+</span> Add           <span style="color: gray;">✎</span> Edit           <span style="color: red;">✖</span> Remove         </div> <table border="1" style="width: 100%; border-collapse: collapse;"> <thead> <tr> <th>#</th> <th>IPv6 Address/Prefix Length</th> </tr> </thead> <tbody> <tr> <td></td> <td>2002:7a64:dcee:1::/64</td> </tr> </tbody> </table> <div style="display: flex; justify-content: space-between; font-size: small; margin-top: 5px;"> <span>Page 1 of 1</span> <span>Show 50 items</span> <span>Displaying 1 -</span> </div>	#	IPv6 Address/Prefix Length		2002:7a64:dcee:1::/64
#	IPv6 Address/Prefix Length				
	2002:7a64:dcee:1::/64				

## Set Up the 6to4 Tunnel on the ZyWALL/USG

In the ZyWALL/USG, go to **CONFIGURATION > Network > Interface > Tunnel > Add**, Select **Enable**. Enter **tunnel0** as the **Interface Name** and select **6to4** as the **Tunnel Mode**. In the **6to4 Tunnel Parameter** section, this example just simply uses the default 6to4 Prefix, **2002::/16**. Enter your **Relay Router**'s IP address (**192.88.99.1** in this example). Select **wan1** as the **Gateway**. Click **OK**.

**CONFIGURATION > Network > Interface > Tunnel**

General Settings	
<input checked="" type="checkbox"/> Enable	
Interface Properties	
Interface Name:	tunnel0
Zone:	TUNNEL
Tunnel Mode:	6to4
IPv6 Address Assignment	
Metric:	0 (0-15)
6to4 Tunnel Parameter	
6to4 Prefix:	2002::/16
Relay Router:	192.88.99.1 (Optional)
<b>NOTE: traffic destined to the non-6to4 prefix domain tunnels to the relay router</b>	
<input type="checkbox"/> Advance	

Gateway Settings	
My Address	
<input checked="" type="radio"/> Interface	
ge2	DHCP client -- 10.214.30.82/255.255.255.0
<input type="radio"/> IP Address	
0.0.0.0	
Remote Gateway Address:	Automatic

## Test the Result

Connect a computer to the ZyWALL/USG's LAN1.

Enable IPv6 support on your computer. In Windows XP, you need to use the IPv6 install command in a Command Prompt. In Windows 7, IPv6 is supported by default. You can enable IPv6 in the **Control Panel > Network and Sharing Center > Local Area Connection** screen.

Your computer should get an IPv6 IP address (starting with 2002:7a64:dcee:1: in this example) from the ZyWALL/USG.

### Window 7 > cmd > ipconfig

```
C:\Windows\system32>ipconfig
Windows IP Configuration

Ethernet adapter Local Area Connection:

    Connection-specific DNS Suffix  . : localdomain
    IPv6 Address . . . . .           : 2002:7a64:dcee:1:dc9:e2ff:7d32:19c9
    Temporary IPv6 Address . . . . . : 2002:7a64:dcee:1:393c:37d8:5564:8f34
    Link-local IPv6 Address . . . . . : fe80::dc9:e2ff:7d32:19c9%12
    IPv4 Address . . . . .           : 192.168.1.34
    Subnet Mask . . . . .           : 255.255.255.0
    Default Gateway . . . . .       : fe80::b2b2:dccf:fe70:c1d8%12
                                      192.168.1.1
```

Type **ping -6 ipv6.google.com** in a Command Prompt to test. You should get a response.

### Window 7 > cmd > ping -6 ipv6.google.com

```
C:\Windows\system32>ping -6 ipv6.google.com
Pinging ipv6.l.google.com [2404:6800:4001:801::1000] with 32 bytes of data:
Reply from 2404:6800:4001:801::1000: time=69ms
Reply from 2404:6800:4001:801::1000: time=69ms
Reply from 2404:6800:4001:801::1000: time=69ms
Reply from 2404:6800:4001:801::1000: time=69ms
Ping statistics for 2404:6800:4001:801::1000
    Packets: Sent = 4, Received = 4, Lost = 0 (0% loss),
    Approximate round trip times in milli-seconds:
        Minimum = 69ms, Maximum = 69ms, Average = 69ms
```

## What Could Go Wrong?

If your IPv6 connection is not working, please make sure you disable Auto-Configuration on the LAN1 IPv6 interface. Enabling it will cause two default routes, however, the ZyWALL/USG only needs a default route generated by your relay router setting. Also, make sure you enable the WAN1 IPv4 interface. In 6to4, the ZyWALL/USG uses the WAN1 IPv4 interface to forward your 6to4 packets over the IPv4 network.

In Windows, some IPv6 related tunnels may be enabled by default such as Teredo and 6to4 tunnels. It may cause your computer to handle IPv6 packets in an unexpected way. It is recommended to disable those tunnels on your computer.

## How to Set Up an IPv6-in-IPv4 Tunnel

This example shows how to configure your ZyWALL/USG to create IPv6-in-IPv4 Tunnel. In this example, the ZyWALL/USG acts as IPv6-in-IPv4 routers which connect the IPv4 Internet and an individual IPv6 network. This configuration example only shows the settings on ZyWALL/USG\_Z. You can use similar settings to configure ZyWALL/USG\_Y.

ZyWALL/USG with IPv6-in-IPv4 Tunnel Example

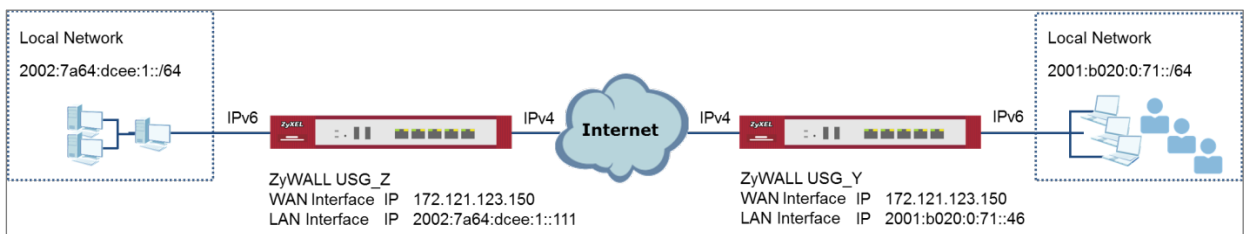

 Note: All network IP addresses and subnet masks are used as examples in this article. Please replace them with your actual network IP addresses and subnet masks. This example was tested using USG310 (Firmware Version: ZLD 4.25).

## Set Up the LAN IPv6 Interface on the ZyWALL/USG

In the ZyWALL/USG, go to **CONFIGURATION > Network > Interface > Ethernet > lan1**. Select **Enable Interface** and **Enable IPv6**. Type **2002:7a64:dcee:1::111/128** in the **IPv6 Address/Prefix Length** field for the LAN1's IP address.

Enable **Router Advertisement**. Then click **Add** in the **Advertised Prefix Table** to add **2002:7a64:dcee:1::/64**. The LAN1 hosts will get the network prefix through the router advertisement messages sent by the LAN1 IPv6 interface periodically. Click **OK**.



## CONFIGURATION > Network > Interface > Ethernet > lan1 > General Settings

**General Settings**

Enable Interface

---

**General IPv6 Setting**

Enable IPv6 ?

---

**Interface Properties**

Interface Type:  ?

Interface Name:

Port: P5, P6

Zone:  ?

MAC Address: B8:EC:A3:A9:C0:0F

Description:  (Optional)

---

**IPv6 Address Assignment**

Enable Stateless Address Auto-configuration (SLAAC)

Link-Local Address: fe80::baec:a3ff:fea9:c00f/64

IPv6 Address/Prefix Length:  (Optional)

## CONFIGURATION > Network > Interface > Ethernet > lan1 > IPv6 Router

### Advertisement Setting

**IPv6 Router Advertisement Setting**

Enable Router Advertisement

Advance

Router Preference:

Advance

Advertised Prefix Table

+ Add ✎ Edit ✖ Remove

#	IPv6 Address/Prefix Length
1	2002:7a64:dcee:1::/64

⏪ ⏩ Page  of 1 ⏪ ⏩ Show  items Displaying 1 -

## Set Up the 6to4 Tunnel on the ZyWALL/USG

In the ZyWALL/USG, go to **CONFIGURATION > Network > Interface > Tunnel > Add** and select **Enable**. Enter **tunnel0** as the **Interface Name** and select **IPv6-in-IPv4** as the **Tunnel Mode**. Select **wan1** as the gateway interface. Enter your **Remote Gateway Address (172.121.123.150** in this example). Click **OK**.

**CONFIGURATION > Network > Interface > Tunnel**

**General Settings**

Enable

**Interface Properties**

Interface Name: tunnel0

Zone: TUNNEL

Tunnel Mode: IPv6-in-IPv4

**IPv6 Address Assignment**

IPv6 Address/Prefix Length: (Optional)

Metric: 0 (0-15)

**Gateway Settings**

My Address

Interface

ge2 DHCP client -- 10.214.30.82/255.255.255.0

IP Address

0.0.0.0

Remote Gateway Address: 172.121.123.150

## Set Up the Policy Route on the ZyWALL/USG

In the ZyWALL/USG, go to **CONFIGURATION > Network > Routing > IPv6 Configuration > Add**, click **Create New Object** to create an IPv6 address object with the address prefix of **2002:7a64:dcee:1::/64**. Select **Enable**. Select the address object you just created in the **Source Address** field. Select **any** in the **Destination Address** field. Select **Interface** as the **next-hop** type and then **tunnel0** as the interface. Click **OK**.

**CONFIGURATION > Network > Routing > Policy Route > IPv6 Configuration**

**+ Add IPv6 Address Rule**

Name: Lan1\_subnet

Object Type: SUBNET

IPv6 Address Prefix: 2002:7a64:dcee:1::/64

+ Add Policy Route
? X

Show Advanced Settings Create new Object ▼

**Configuration**

Enable

Description:  (Optional)

**Criteria**

User:

Incoming:

Source Address:

Destination Address:

DSCP Code:

Schedule:

Service:

Advance

**Next-Hop**

Type:

Interface:

## Test the Result

Connect a computer to the ZyWALL/USG's LAN1.

Enable IPv6 support on your computer. In Windows XP, you need to use the IPv6 install command in a Command Prompt. In Windows 7, IPv6 is supported by default. You can enable IPv6 in the **Control Panel > Network and Sharing Center > Local Area Connection** screen.

Your computer should get an IPv6 IP address (starting with 2002:7a64:dcee:1: for this example) from the ZyWALL/USG.

**Window 7 > cmd > ipconfig**

```
C:\Windows\system32>ipconfig

Windows IP Configuration

Ethernet adapter Local Area Connection:

    Connection-specific DNS Suffix . . : localdomain
    IPv6 Address. . . . . : 2002:7a64:dcee:1:dc9:e2ff:7d32:19c9
    Temporary IPv6 Address. . . . . : 2002:7a64:dcee:1:393c:37d8:5564:8f34
    Link-local IPv6 Address . . . . . : fe80::dc9:e2ff:7d32:19c9%12
    IPv4 Address. . . . . : 192.168.1.34
    Subnet Mask . . . . . : 255.255.255.0
    Default Gateway . . . . . : fe80::b2b2:dccf:fe70:c1d8%12
                               192.168.1.1
```

Use the ping -6 [IPv6 IP address] command in a Command Prompt to test whether you can ping a computer behind ZyWALL/USG\_Y. You should get a response.

**Window 7 > cmd > ping -6 2001:b020:0:71::46**

```
C:\Windows\system32>ping -6 2001:b020:0:71::46

Pinging 2001:b020:0:71::46 with 32 bytes of data:

Reply from 2001:b020:0:71::46: time=21ms
Reply from 2001:b020:0:71::46: time=21ms
Reply from 2001:b020:0:71::46: time=21ms
Reply from 2001:b020:0:71::46: time=21ms

Ping statistics for 2001:b020:0:71::46
    Packets: Sent = 4, Received = 4, Lost = 0 (0% loss),
    Approximate round trip times in milli-seconds:
        Minimum = 21ms, Maximum = 21ms, Average = 21ms
```

## What Could Go Wrong?

If your IPv6 connection is not working, please make sure you enable the WAN1 IPv4 interface. In IPv6-in-IPv4, the ZyWALL/USG uses the WAN1 IPv4 interface to forward your 6to4 packets to the IPv4 network.

In Windows, some IPv6 related tunnels may be enabled by default such as Teredo and 6to4 tunnels. It may cause your computer to handle IPv6 packets in an unexpected way. It is recommended to disable those tunnels on your computer.

## How to Update Firmware Automatically from a USB Storage

This example illustrates how to update the ZyWALL/USG's firmware automatically from a USB storage. With this feature, it is more efficient for users to upgrade the firmware for numerous devices without Internet or GUI access. The user can also downgrade the firmware by using this feature.

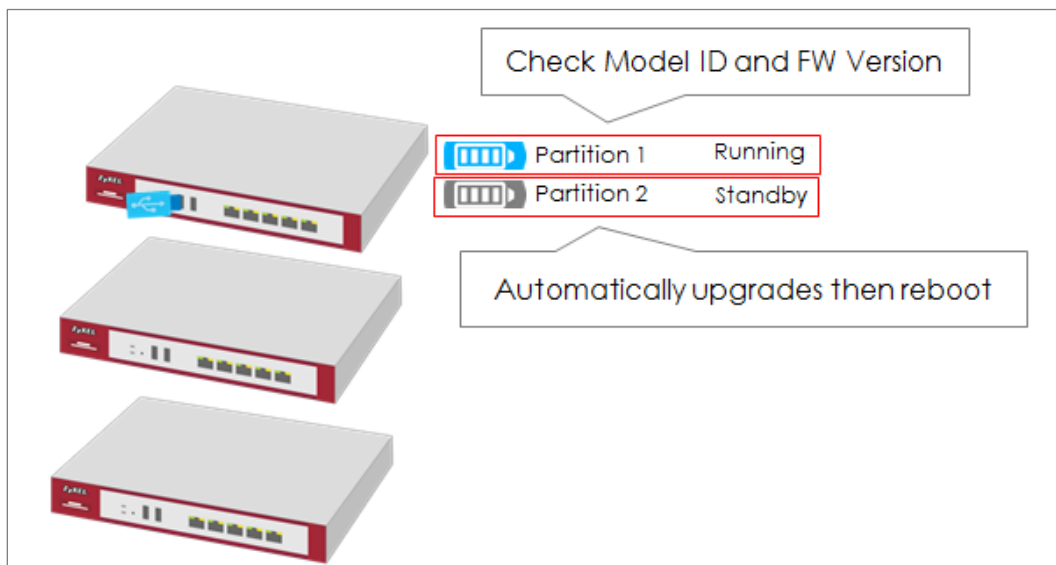

**Figure 1** Automatic USB Firmware Upgrade

 **Note:** This feature does not support Device HA Pro firmware auto upgrade to passive devices. Do not use USB firmware upgrade on the devices with Device HA Pro function activated. This example was tested using the USG210 (Firmware Version: ZLD 4.25).

- 1 Enable the USB firmware upgrade function by CLI command.
- 2 Save the firmware on the USB.
- 3 Plug the USB into the device.
- 4 The device checks running partition for the model ID and the firmware version.
- 5 Upgrade the firmware to the standby partition and then the device reboots.

## Enable the USB Firmware Upgrade Function by CLI Command

For security concerns, the function is disabled by default. The administrator needs to enable the function by the following CLI command:

```
Router(config)# usb-storage update-firmware enable
```

## Save the Firmware on the USB

There are two ways to create the firmware folder on the USB storage.

- 1 Follow the folder structure to create the firmware folder manually. It does not matter if the letters of the folder name are capitalized or not. For example: D:\vpn300\_dir\firmware

### Create the Firmware Folder Manually: Root Directory\vpn300\_dir\firmware

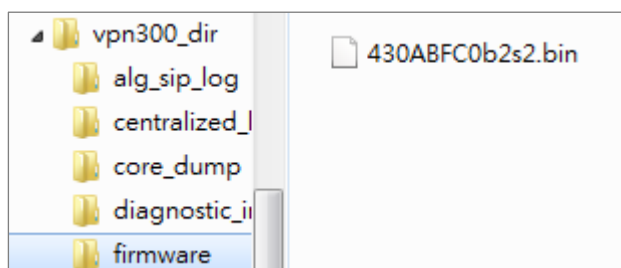

- 2 Plug the USB storage to the device and the device will automatically create the folder **Vpn300\_dir**, which includes the following sub-folders. Save the .bin file to the **firmware** folder.

centralized\_log

core\_dump

diagnostic\_info

firmware

packet\_trace

## Firmware Folder is Created Automatically

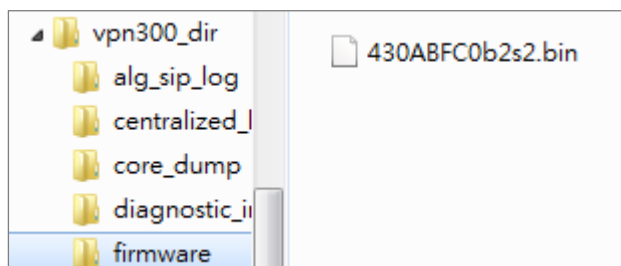

## Plug the USB into the Device

Once the .bin file in the firmware folder is detected, the device will copy it to the RAM.

## Plug the USB storage into the USB port

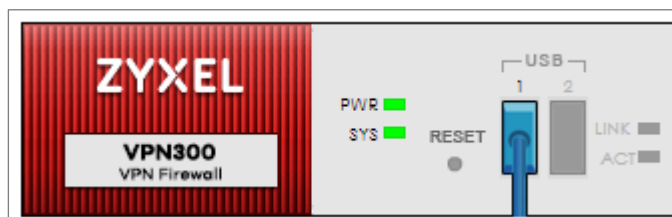

The following message shows on the console if the device fails to copy the .bin file.

```
Router> USB update-firmware failed: firmware copy fail
```

## The Device Checks Running Partition for the Model ID and the Firmware Version

The device checks the USB firmware with the running partition only. It does not check the standby partition.

## 1 Check model ID:

If incompatible, the device deletes the firmware in the RAM.

If compatible, the device checks the firmware version.

## 2 Check firmware version:

If it is the same as the running firmware, the device deletes the firmware in the RAM.

If it is not the same as the running version, the device starts to upgrade to the standby partition.

### Check Model ID and Firmware Version

```
Router(config)# firmware verifying...
Product model id is compatible!!
This product's model id is E134
The kernel image supports the following product model id:
E134
firmware updating...
Please Wait about 5 minutes!!
```

### Check Firmware Status

The device upgrades the standby partition and then reboots. After been upgraded to the standby partition, the device automatically reboots to switch from running to standby partition. The SYS LED starts to blink when the device begins to upgrade its firmware until the rebooting process is completed.

### Check the Firmware Version on the Dashboard

Device Information		
System Name	Serial Number	MAC Address Range
<a href="#">VPN300</a>	S172L15290016	B8:EC:A3:A9:C0:0B ~ B8:EC:A3:A9:C0:12
System Uptime	Boot Status	Firmware Version
00:29:24	OK	<a href="#">V4.30(A8FC.0)b2 / 2017-07-28 22:44:54</a>
Firmware Upgrade License	Current Date/Time	
Activated	<a href="#">2017-09-07 / 11:09:03 UTC+08:00</a>	



**MONITOR > Log > View log**

254	201...	info	VPN300 is configured successfully with startup configuration file.
-----	--------	------	--

## What Can Go Wrong?

- 1 The USB storage must use the FAT16, FAT32, EXT2, or EXT3 file system. Otherwise, it may not be detected by the ZyWALL/USG.
- 2 The device only checks the firmware under the specific folder. Therefore, make sure the firmware is saved in the correct folder under the root directory: `\ProductName_dir\firmware`. For example:  
`\vpn300_dir\firmware`
- 3 If there are multiple firmware files in the firmware folder of one model, the device only checks the first one in order.

**Multiple firmware files of one model in the same folder is not supported.**

430_Internal_Release_Note_b2s2.docx	2017/8/31 下午 0...	Microsoft Word ...
430ABFC0b2s2.bin	2017/8/31 下午 0...	BIN 檔案
430ABFC0b2s2.conf	2017/8/31 下午 0...	CONF 檔案
430ABFC0b2s2.db	2017/8/31 下午 0...	Data Base File
430ABFC0b2s2.ri	2017/8/31 下午 0...	RI 檔案
430ABFC0b2s2-MIB.zip	2017/8/31 下午 0...	壓縮的 (zipped) ...
ABFC119.bm	2017/8/31 下午 0...	BM 檔案
firmware.xml	2017/8/31 下午 0...	XML Document

- 4 Make sure the product model ID of the USB firmware is compatible with the device. The device writes logs on the console and device log if the firmware model ID is incompatible.

## Console Message

```
Router(config)# firmware verifying...
Product model id is not compatible!!
This product's model id is E134
The ZLD-current image supports the following product model id :
E10B
USB update-firmware fail: File damaged. file name: 430AALA0a1.bin
```

## MONITOR > Log > View log

#	Time	Priority	Category	Message	Note
20	2017-09-11 09:54...	alert	System	USB update-firmware fail: File damaged. file name: 430AALA0a1.bin	USB update firm...

- 5 Make sure the version of the USB firmware is different from that of the running partition. The device writes logs on the console and device log if the firmware version is the same as the running firmware.

## Console Message

```
Router(config)# firmware verifying...
USB update-firmware fail: Same firmware version. file name: 430ABFC0b2s2.bin
```

## MONITOR > Log > View log

#	Time	Priority	Category	Message	Note
166	2017-09-11 09:42...	notice	System	Device do not have token to access cloud server [count=2]	System
201	2017-09-11 09:42...	notice	System	Device do not have token to access cloud server [count=2]	System
236	2017-09-11 09:41...	notice	System	Device do not have token to access cloud server [count=2]	System
282	2017-09-11 09:40...	notice	System	Device do not have token to access cloud server [count=2]	System
283	2017-09-11 09:40...	alert	System	USB update-firmware fail: Same firmware version. file name: 430ABFC0b2s2.bin	USB update firm...
786	2017-09-11 09:26...	notice	System	Device do not have token to access cloud server [count=2]	System

- 6 This feature does not support the Device HA Pro firmware auto upgrade to passive devices. Do not use USB firmware upgrade on devices with

Device HA Pro function activated. When using USB firmware upgrade on a device HA or in a device HA Pro scenario, make sure you plug the USB storage to the passive device for firmware upgrade first. After the passive device has finished firmware upgrading through the USB, plug the USB storage to the active device for firmware upgrade.

## **How to Configure DHCP Option 60 – Vendor Class Identifier**

The following figure depicts how the ZyWALL/USG uses DHCP option 60. By matching the VCI strings, a DHCP client can choose one specific DHCP server on the WAN network. This function is useful when there are several DHCP servers providing different services in an environment. Clients that need Internet service can be directed to the DHCP server which provides Internet connection information with the same option 60 string. IPTV clients may relay to another DHCP server which obtains IPTV service information.

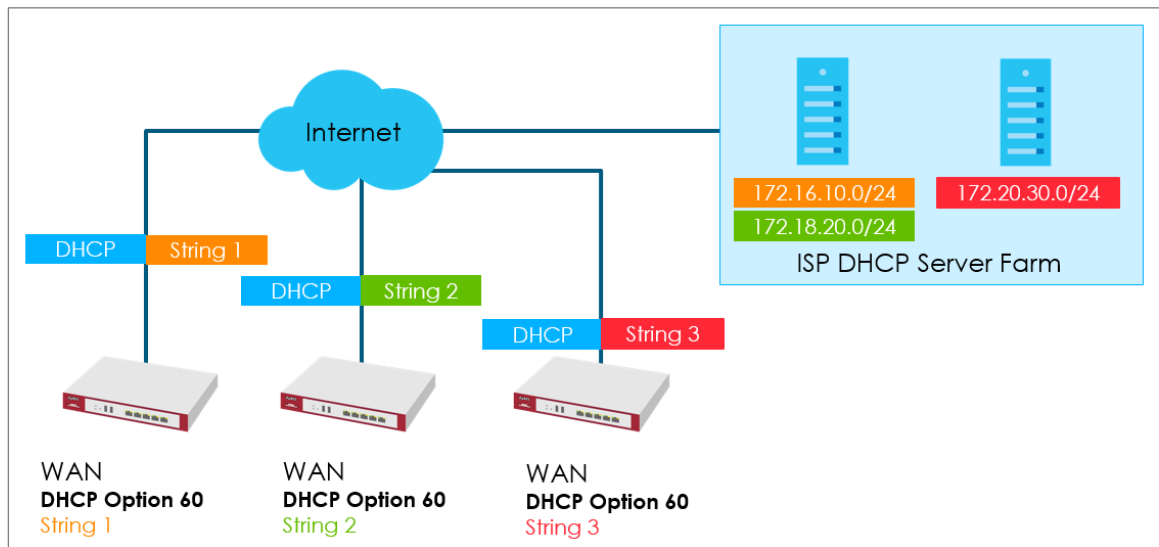

**Figure 1** DHCP Option 60 Vendor Class Identifier

## DHCP Option 60 Deployment Flow

- 1 Enable the WAN ports as DHCP clients (enabled by default).
- 2 Navigate to the WAN interface configuration screen.
- 3 Type in user defined option 60 string in the **Advance** setting section.

## Setting Up DHCP Option 60 on the Web GUI

- 1 In the ZyWALL/USG's navigation panel, go to **Configuration > Network > Interface**.

The screenshot shows the ZyXEL configuration interface with the 'Ethernet' tab selected. A table lists 8 Ethernet interfaces (ge1 to ge8) with their respective IP addresses and masks. The first row (ge1) is highlighted in blue.

#	Sta...	Name	IP Address	Mask
1		ge1	STATIC -- 0.0.0.0	0.0.0.0
2		ge2	DHCP -- 10.214.30.65	255.255.255.0
3		ge3	DHCP -- 10.214.30.66	255.255.255.0
4		ge4	STATIC -- 192.168.91.1	255.255.255.0
5		ge5	STATIC -- 192.168.92.1	255.255.255.0
6		ge6	STATIC -- 192.168.93.1	255.255.255.0
7		ge7	STATIC -- 0.0.0.0	0.0.0.0
8		ge8	STATIC -- 0.0.0.0	0.0.0.0

- Click the **Ethernet** tab, go to **WAN > Edit**. Enter the VCI string in the **Advance** section of **DHCP Option 60**.

The screenshot shows the 'Edit Ethernet' configuration window. The 'IP Address Assignment' section is highlighted with a red box. Under the 'Advance' sub-section, the 'DHCP Option 60' field is set to 'ZYXEL\_CSO'.

**General Settings**

- Enable Interface

**Interface Properties**

- Interface Type: general
- Interface Name: ge1
- Port: P1
- Zone: OPT
- MAC Address: B8:EC:A3:A9:C0:0B
- Description: (Optional)

**IP Address Assignment**

- Get Automatically
- Advance
  - DHCP Option 60: ZYXEL\_CSO (Optional)
- Use Fixed IP Address
  - IP Address: 0.0.0.0

## Setting Up DHCP Option 60 on the CLI

Under the specific interface path, use these commands to:

### Enable option 60

```
Router(config-if-wan1)# ip address dhcp option-60 {VCI_STRING}
```



## How to Configure Device HA Pro

The Device HA feature acts as a failover when one of the devices in the network is dead or can't access the Internet. Therefore, this is a popular feature for network environments. In the previous firmware version, the USG supports AP (Activate-Passive/Master-Backup) mode. In V4.25, the Device HA feature is enhanced and named **Device HA Pro**.

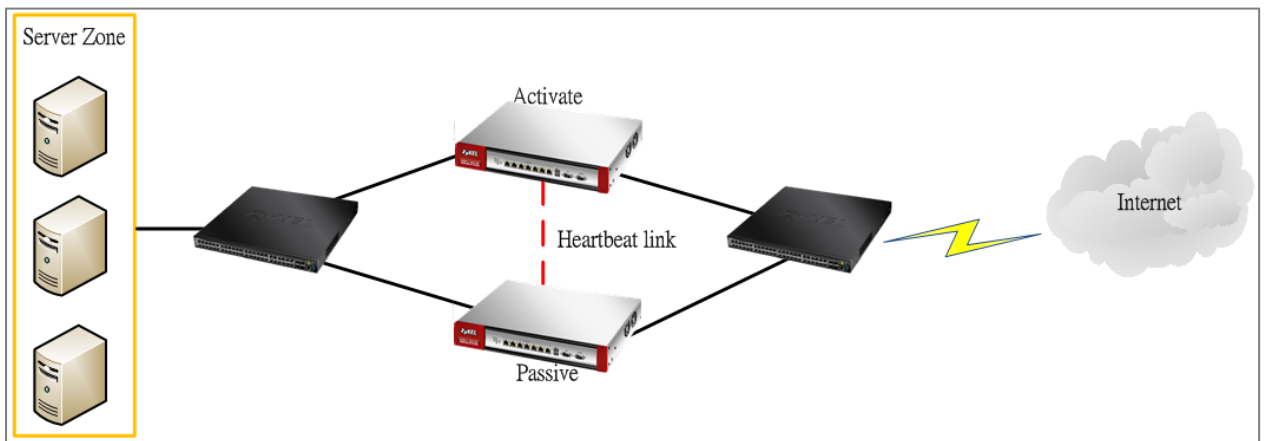

In Device HA Pro, a "heartbeat link" is added for monitoring the interface status and synchronizing settings. Follow the steps below to deploy the Device HA Pro feature in your network environment.

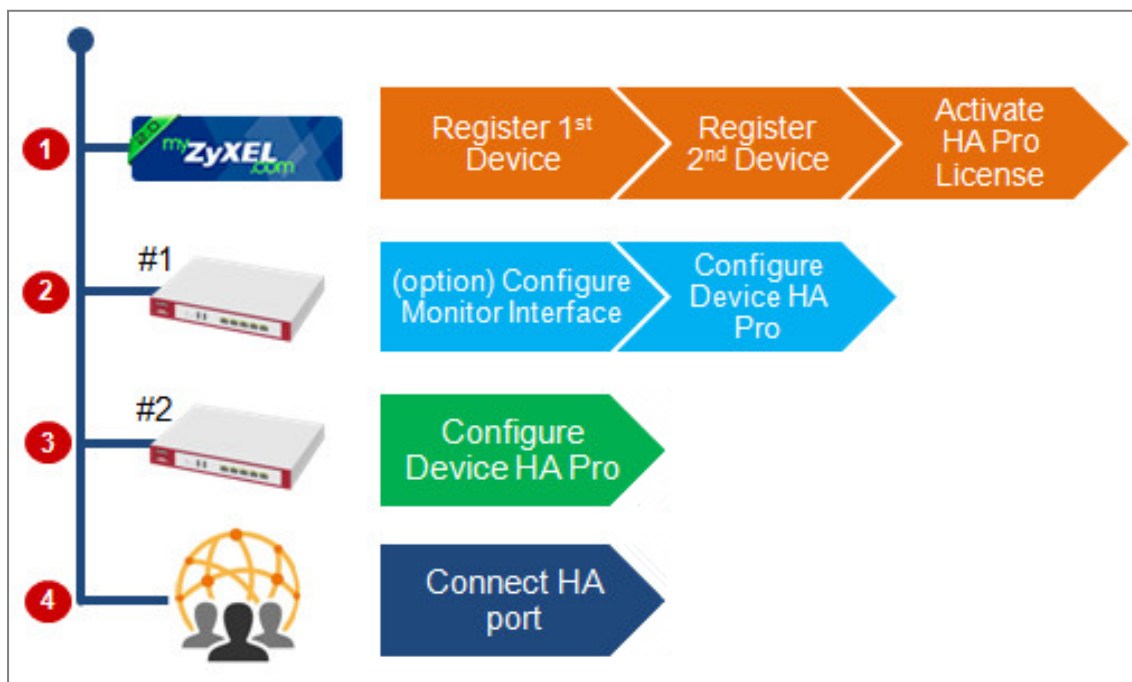

## Device HA Pro License

The Device HA Pro feature is license required. You must register both of your devices on the **myZyXEL.com** server first. Then make sure the Device HA Pro license is available on both of your devices.

Registration
Service

**Service Status**

#	Service	Status	Service Type	Expiration Date	Count
1	Content Filter 2.0	Activated	Trial	2017-10-20	N/A
2	Geo Enforcer	Activated	Standard	2018-10-21	N/A
3	Managed AP Service	Default	Standard		4
4	SSL VPN Service	Default			50
5	Zymesh Service	Not Licensed			N/A
6	Hotspot Management Subscription Ser...	Activated	Trial	2017-10-20	N/A
7	Concurrent Device Upgrade	Default	Standard		200
8	Device HA Pro	Activated	Standard		N/A
9	Firmware Upgrade Service	Activated			N/A

Page 1 of 1 Show 50 items

**Service Refresh**

Service License Refresh

**Note:**  
Update device license information from myZyXEL.com server. If you want to activate license, please go to [portal.myzyxel.com](http://portal.myzyxel.com)

## Behavior of the Device HA Pro

The behavior of the Device HA Pro includes a heartbeat link to monitor the “activate” device’s interface status. If one of the monitored interfaces is dead or fails, the “passive” device’s status will become “activate”. (This means only 1 device’s status can be “activate” at a time.)

Be aware that the Device HA status of the devices might constantly change due to the network environment situation. In the current firmware design, Device HA Pro will not fallback when the primary device interface is working normally again.

## Device-HA Pro Setting Screen

### A. Enable configuration provisioning on the activated device



This function is for the secondary device. If you are configuring the primary device, this function is unnecessary.

**B. Serial number of the licensed device for license synchronization**

Entering the serial number of license from the **myZyXEL.com** server.

**C. Configure the Device HA Pro interface**

Enter the management IP address of the active and passive devices. Also, enter the password for synchronizing configuration with each other.

**D. Monitoring Interfaces**

Select the interfaces which you would like to monitor.

**E. Synchronization**

Enable failover when one of the interfaces fails.

Device HA Status	Device HA Pro	View Log				
<b>Configuration</b>						
<input type="checkbox"/> Enable Configuration Provisioning From Active Device.						
Serial Number of Licensed Device for License Synchronization:	<input type="text" value="S172L15290017"/>					
Active Device Management IP:	<input type="text" value="20.20.20.1"/>					
Passive Device Management IP:	<input type="text" value="20.20.20.2"/>					
Subnet Mask:	<input type="text" value="255.255.255.0"/>					
Password:	<input type="password" value="...."/>					
Retype to Confirm:	<input type="password" value="...."/>					
Heartbeat Interval:	<input type="text" value="2"/>	seconds (1-10)				
Heartbeat Lost Tolerance:	<input type="text" value="2"/>	(1-10)				
<b>Monitor Interface</b>						
<table border="1"> <thead> <tr> <th>Available Interfaces</th> <th>Monitor Interface</th> </tr> </thead> <tbody> <tr> <td> <div style="border: 1px solid gray; padding: 2px;"> <div style="text-align: center;">=== Object ===</div> <div style="font-family: monospace;">                     ge3                      ge4                      ge5                      ge6                 </div> </div> </td> <td> <div style="border: 1px solid gray; padding: 2px;"> <div style="text-align: center;">=== Object ===</div> <div style="font-family: monospace;">                     ge1                      ge2                 </div> </div> </td> </tr> </tbody> </table>	Available Interfaces	Monitor Interface	<div style="border: 1px solid gray; padding: 2px;"> <div style="text-align: center;">=== Object ===</div> <div style="font-family: monospace;">                     ge3                      ge4                      ge5                      ge6                 </div> </div>	<div style="border: 1px solid gray; padding: 2px;"> <div style="text-align: center;">=== Object ===</div> <div style="font-family: monospace;">                     ge1                      ge2                 </div> </div>		
Available Interfaces	Monitor Interface					
<div style="border: 1px solid gray; padding: 2px;"> <div style="text-align: center;">=== Object ===</div> <div style="font-family: monospace;">                     ge3                      ge4                      ge5                      ge6                 </div> </div>	<div style="border: 1px solid gray; padding: 2px;"> <div style="text-align: center;">=== Object ===</div> <div style="font-family: monospace;">                     ge1                      ge2                 </div> </div>					
<b>Failover Detection</b>						
<input checked="" type="checkbox"/> Enable Failover When Interface Failure (Option)						
<input type="checkbox"/> Enable Failover When Device Service Fails (Option)						

## The Main Function of the Device HA Pro

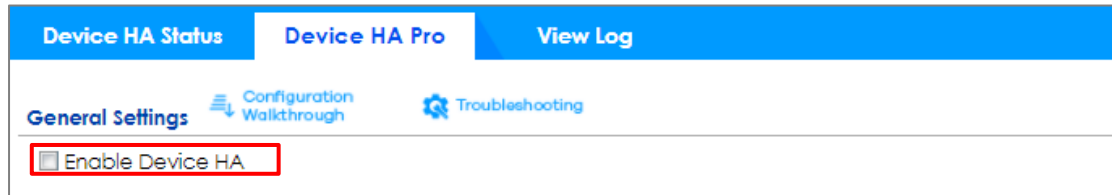

## Heartbeat Link

The heartbeat port is a new physical port on the device.

After you have enabled Device HA Pro, the devices will transmit multicast packets (UDP 694) to check each device's status.

When the passive device is working properly, the system LED light will be on. Only the heartbeat port's LED light can be on.

## Suggestions

1. Transfer all the licenses to the primary device. This helps to avoid the system from recounting licenses every time.
2. Enable the connectivity check function on the monitored interfaces. When an interface doesn't receive any response from the remote server for a certain period of time, the device will consider the interface status as fail. Then the Device HA Pro feature will change the status of the interface.

## How do I Configure Device HA Pro in My Current Environment?

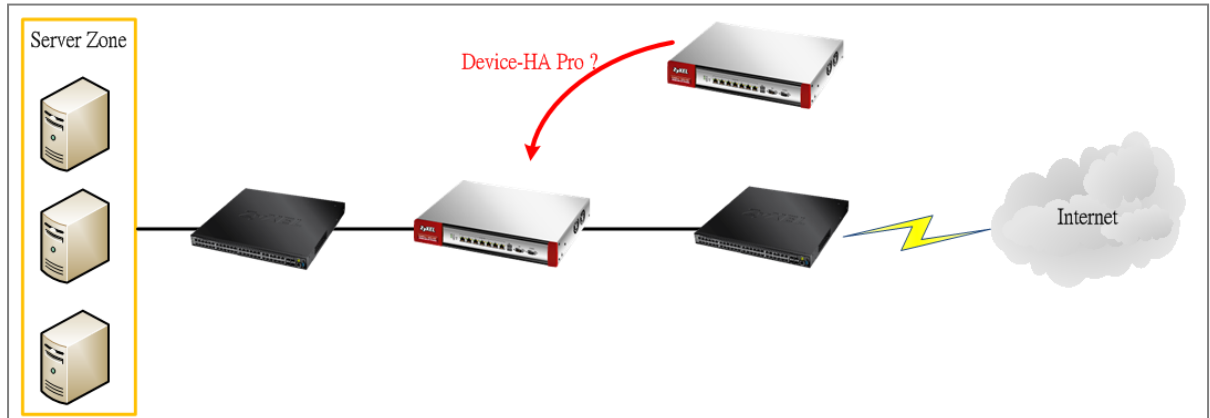

### License

The Device HA Pro feature is license required. Please go to register both of your devices on **myZyXEL.com** and make sure the devices have the license after syncing with the **myZyXEL.com** server.

Registration
Service

**Service Status**

#	Service	Status	Service Type	Expiration Date	Count
1	Content Filter 2.0	Activated	Trial	2017-10-20	N/A
2	Geo Enforcer	Activated	Standard	2018-10-21	N/A
3	Managed AP Service	Default	Standard		4
4	SSL VPN Service	Default			50
5	Zymesh Service	Not Licensed			N/A
6	Hotspot Management Subscription Ser...	Activated	Trial	2017-10-20	N/A
8	Device HA Pro	Activated	Standard		N/A
9	Firmware Upgrade Service	Activated			N/A

Page 1 of 1 Show 50 items

**Service Refresh**

[Service License Refresh](#)

**Note:**  
Update device license information from myZyXEL.com server. If you want to activate license, please go to [portal.myzyxel.com](http://portal.myzyxel.com)

## Configurations on the Primary Device

1. Go to the **Configuration > Device HA > Device HA Pro** screen.
2. Enter the device's license serial number from the **myZyXEL.com** server.
3. Enter the management IP address after enabling the Device HA Pro feature.
4. Select the interfaces which you would like to monitor.
5. Enable failover when an interface fails.
6. Click **Apply**.

Device HA Status	Device HA Pro	View Log
<b>Configuration</b>		
<input type="checkbox"/> Enable Configuration Provisioning From Active Device.		
Serial Number of Licensed Device for License Synchronization:	S172L15290017	
Active Device Management IP:	20.20.20.1	
Passive Device Management IP:	20.20.20.2	
Subnet Mask:	255.255.255.0	
Password:	••••	
Retype to Confirm:	••••	
Heartbeat Interval:	2	seconds (1-10)
Heartbeat Lost Tolerance:	2	(1-10)

Monitor Interface															
<table border="1"> <thead> <tr> <th>Available Interfaces</th> <th>Monitor Interface</th> </tr> </thead> <tbody> <tr> <td>=== Object ===</td> <td>=== Object ===</td> </tr> <tr> <td>ge3</td> <td>ge1</td> </tr> <tr> <td>ge4</td> <td>ge2</td> </tr> <tr> <td>ge5</td> <td></td> </tr> <tr> <td>ge6</td> <td></td> </tr> <tr> <td>_</td> <td></td> </tr> </tbody> </table>	Available Interfaces	Monitor Interface	=== Object ===	=== Object ===	ge3	ge1	ge4	ge2	ge5		ge6		_		
Available Interfaces	Monitor Interface														
=== Object ===	=== Object ===														
ge3	ge1														
ge4	ge2														
ge5															
ge6															
_															
<b>Failover Detection</b>															
<input checked="" type="checkbox"/> Enable Failover When Interface Failure (Option)															
<input type="checkbox"/> Enable Failover When Device Service Fails (Option)															

Go to the **Configuration > Device HA > General** screen.

Select **Enable Device HA** and click **Apply** to enable Device HA Pro.

Device HA Status	Device HA Pro	View Log
<a href="#">General Settings</a> <a href="#">Configuration Walkthrough</a> <a href="#">Troubleshooting</a>		
<input checked="" type="checkbox"/> Enable Device HA		

## Configurations on the Secondary Device

Go to the **Configuration > Device HA > Device-HA Pro** screen.

Select **Enable Configuration Provisioning from Active Device**.

Click **Apply**.

The screenshot shows the 'Device HA Pro' configuration page with three tabs: 'Device HA Status', 'Device HA Pro', and 'View Log'. The 'Configuration' section includes a red-bordered checkbox labeled 'Enable Configuration Provisioning From Active Device'. Below it are input fields for 'Serial Number of Licensed Device for License Synchronization', 'Active Device Management IP', 'Passive Device Management IP', 'Subnet Mask', 'Password', and 'Retype to Confirm'. There are also numeric input fields for 'Heartbeat Interval' (set to 2) and 'Heartbeat Lost Tolerance' (set to 2), with units 'seconds (1-10)' and '(1-10)' respectively. The 'Monitor Interface' section features a list of 'Available Interfaces' (ge1, ge2, ge3, ge4) and an empty 'Monitor Interface' box, with plus signs indicating the ability to add interfaces. The 'Failover Detection' section contains two unchecked checkboxes: 'Enable Failover When Interface Failure (Option)' and 'Enable Failover When Device Service Fails (Option)'.

Go to the **Configuration > Device HA > General** screen.

Select **Enable Device HA** and click **Apply**.

Before the Device HA Pro feature is enabled on the secondary device, a **warning message** will pop-up for you to confirm. Click **OK** to enable it.

不會顯示這個訊息

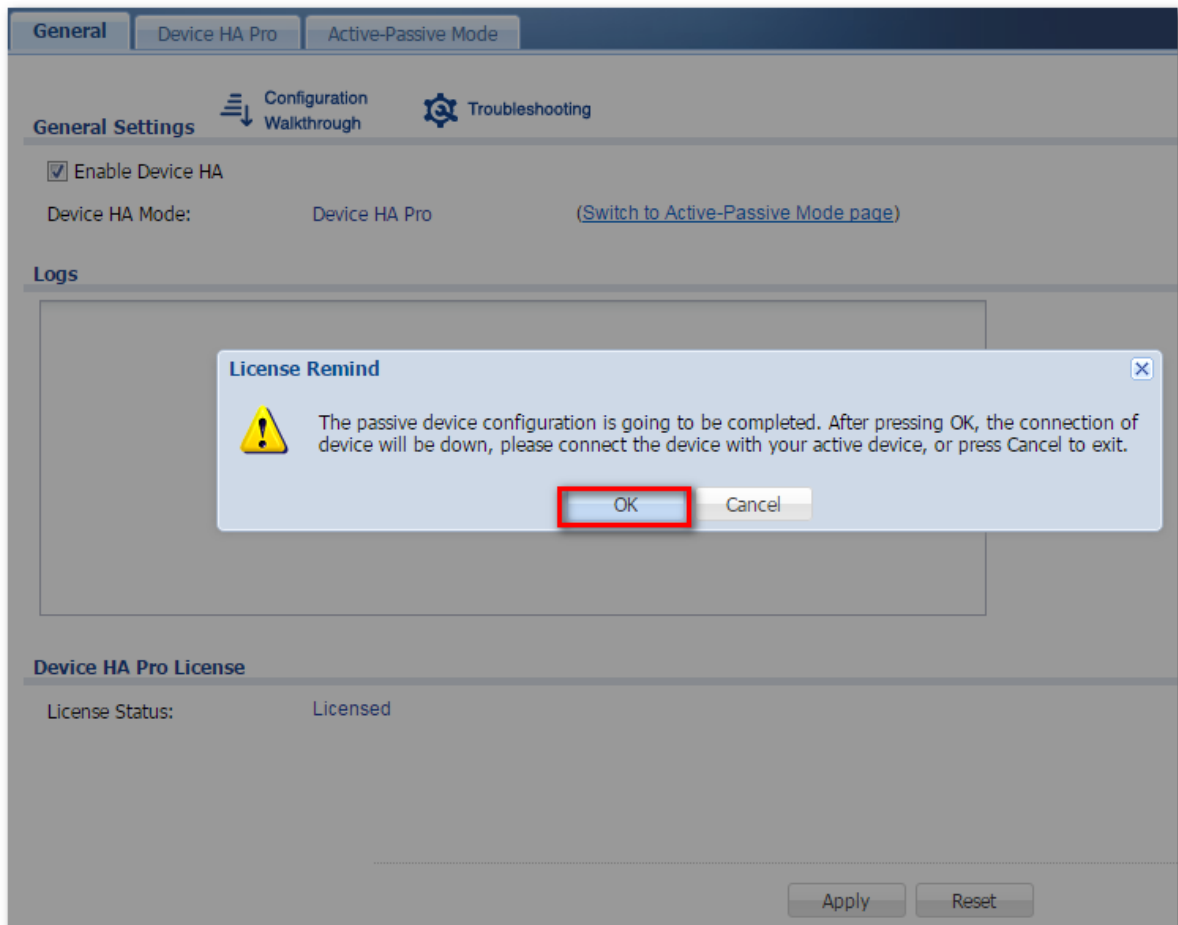

## 1. Connecting the Device HA Pro Port

The Device HA Pro port is a new physical port on the DUT. You can use a cable to connect the devices with each other.

## What can go wrong?

### 1. Why I can't see correct license status from myzyxel.com server?

On the Device-HA Pro setting, there is a function "Serial number of the licensed device for license synchronization". You should enter device's S/N which with licenses. So you can transfer all of the licenses to "Activate" device, and enter this device's S/N in frame.

### 2. Why nothing happened after enabled Device-HA Pro?

After you enabled Device-HA Pro, the secondary device will not forward any traffic any more except the latest physical port. So you must confirm the physical port already connected with each other.

### 3. Why after Device-HA failover to secondary device, it will not fallback to primary device?

Because Device-HA Pro purpose is for networking environment stability, so after mechanism failover to secondary device it will keep the latest status even primary device is back. It can avoid the network service unstable.

## How to setup Two-Factor Authentication for admin login

2 Factor Authentication is a function can prevent your device login by hacker. It needs additional verification code after logged into WebGUI/SSH/Telnet

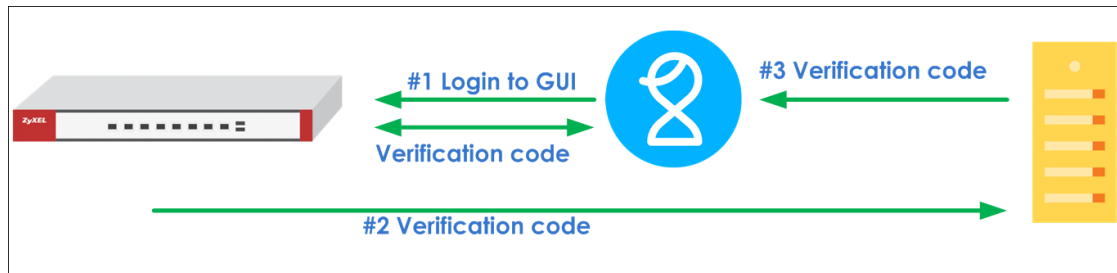

You can follow these steps to setup 2 factor authentication when logging to system.

## Setup SMTP function on your device

Go to **CONFIGURATION > System > Notification > Mail Server** Field your SMTP server configuration.

- Mail server
- Mail server ports
- Mail From
- SMTP Authentication



Mail Server	SMS
<b>General Settings</b>	
Mail Server:	<input type="text" value="smtp.gmail.com"/> (Outgoing SMTP Server Name or IP Address)
Mail Subject:	<input type="checkbox"/> Append system name <input type="checkbox"/> Append date time
Mail Server Port:	<input type="text" value="587"/> <input checked="" type="checkbox"/> TLS Security <input checked="" type="checkbox"/> STARTTLS <input type="checkbox"/> Authenticate Server
Mail From:	<input type="text" value="s.y@gn"/> (Email Address)
<input checked="" type="checkbox"/> SMTP Authentication	
User Name :	<input type="text" value="s.y"/>
Password:	<input type="password" value="....."/>
Retype to Confirm:	<input type="password" value="....."/>
<b>Schedule</b>	
Time For Sending Report:	<input type="text" value="0"/> (hours) <input type="text" value="0"/> (minutes)

 Note: Must make sure SMTP Server configuration is correct otherwise user will unable receive mail successfully.

## Create admin type user on device

Go to **Configuration > Object > User/Group > User** Click Add button to create an user and user type is admin.

And also entered email address of this user.

**Edit User stanley**

**User Configuration**

User Name : stanley

User Type: admin

Password: .....

Retype: .....

Description: Local User

Email: st...@gn...

Mobile Number:

Authentication Timeout Settings

Use Default Settings  Use Manual Settings

Lease Time: 1440 minutes

Reauthentication Time: 1440 minutes

OK Cancel

## Setup Two-Factor Authentication for admin on your device

Go to **Configuration > Object > Auth Method > Two-Factor Authentication > Admin Access**

Enable the function and add admin user which you added in step2 in the rule, and you can select what services are 2 Factor authentication needed.

The screenshot shows the configuration interface for Two-factor Authentication. At the top, there are tabs for 'Authentication Method' and 'Two-factor Authentication'. Under 'Two-factor Authentication', there are sub-tabs for 'VPN Access' and 'Admin Access'. The 'Admin Access' tab is selected. The 'General Settings' section includes a checked 'Enable' checkbox, a 'Valid Time' of 3 minutes, and checked checkboxes for 'Web', 'SSH', and 'TELNET'. The 'User' section shows two 'Selectable User Objects' lists; the second list contains the user 'stanley'. The 'Delivery Settings' section has 'Email' selected for the 'Deliver Authorize Link Method'.

## Test the Result

After setup these steps and login to device by admin user, the verification code is required.

### Web Service:

The screenshot shows the ZyXel ATP500 verification screen. It features the ZyXel logo and the model name 'ATP500'. The instruction reads: 'Enter Two-factor Authentication Verification code and click to verify.' Below this is a text input field with a red dashed border and a red warning icon to its right. A 'Verify' button is located at the bottom of the screen.

### SSH Service:

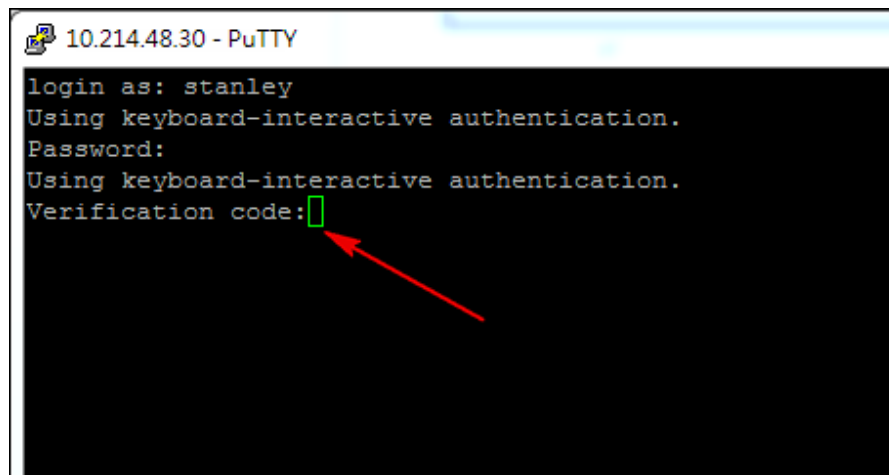

```
10.214.48.30 - PuTTY
login as: stanley
Using keyboard-interactive authentication.
Password:
Using keyboard-interactive authentication.
Verification code:█
```

You will receive verification code by Email.

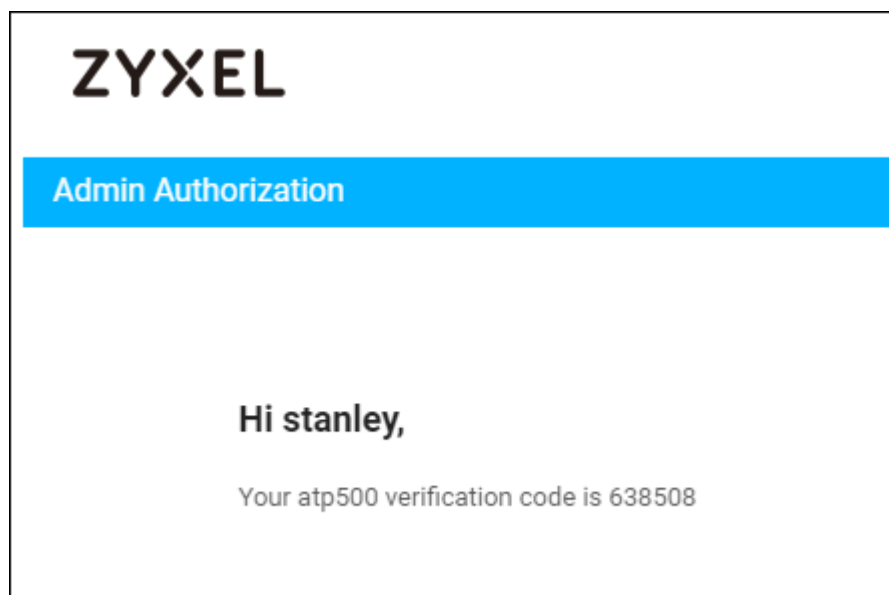

## What Can Go Wrong?

1. **Must make sure SMTP server configuration is correct.**
2. **If you would like to add “admin” into the 2FA rule, you must do verify admin email first**

2-1 Enter Email address and click “send code” button

The screenshot shows a dialog box titled "Edit User admin". Under the "User Configuration" section, the "Email" field contains "s...y@gn" and is highlighted with a red box. To its right is a "Send Code" button, also highlighted with a red box. Other fields include "User Name" (admin), "User Type" (admin), "Password" and "Retype" (masked with dots), "Description" (Administration account), "Mobile Number", and "Authentication Timeout Settings" (Lease Time: 30 minutes, Reauthentication Time: 0 minutes). The "Use Manual Settings" radio button is selected. "OK" and "Cancel" buttons are at the bottom right.

2.2 After clicked “Send Code”, you will receive code by Email.

2.3 Enter code that you received.

The screenshot shows a dialog box titled "Verify Email". The "Email" field contains "songsongstanley@gr". The "Code" field is empty and highlighted with a red box, with a red exclamation mark icon to its right. "OK" and "Cancel" buttons are at the bottom right.

2.4 After admin Email is verified, it will display success.

**Edit User admin**

**User Configuration**



User Name : admin

User Type: admin

Password: .....

Retype: .....

Description: Administration accou

Email: s y@gn  

Mobile Number:

Authentication Timeout Settings

Lease Time: 30 minutes

Reauthentication Time: 0 minutes

Send Code

Send Code

Use Default Settings  Use Manual Settings

OK Cancel

## How to configure Email Security for Phishing mail? (This feature is only supported on ATP series)

The following depicts a sample configuration of Email security for Phishing mail.

Phishing is a type of online scam where criminals send an email with a fake website and asking you to provide sensitive information.

An example of phishing attack:

1. Attacker creates an fake banking websites which copy the content from real banking website
2. Attacker sends user an phishing emails with an embed URLs to ask change the new banking password
3. User opens the mail then click to the embed URLs, it redirects user access to fake banking websites.
4. User enters the current banking account when they attempt change the password
5. Attacker gets the user's banking account and can steal user's money

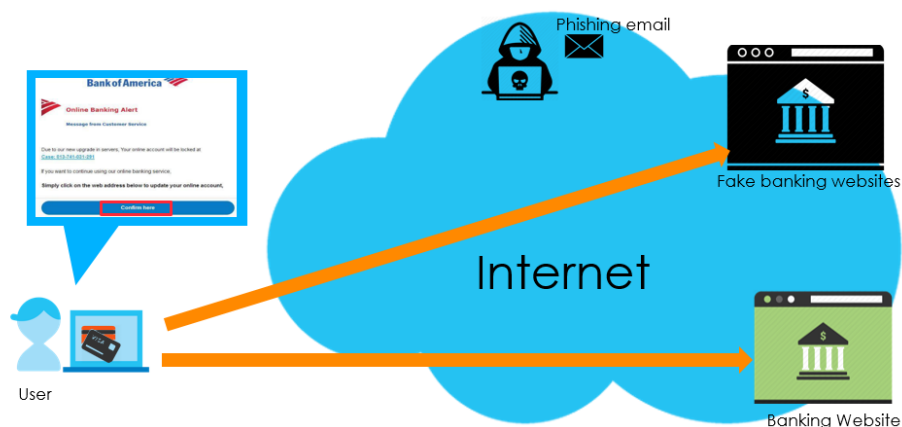

**Figure 1** Using Sandboxing to Detect Unknown Malware

## How it works

Gateway inspects the email content to detect the embedded URLs. With Anti-phishing enhancement, ATP gateway inspects the mail content to detect the

embedded URLs.

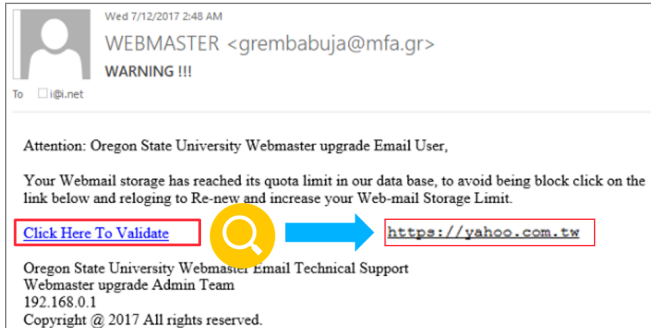
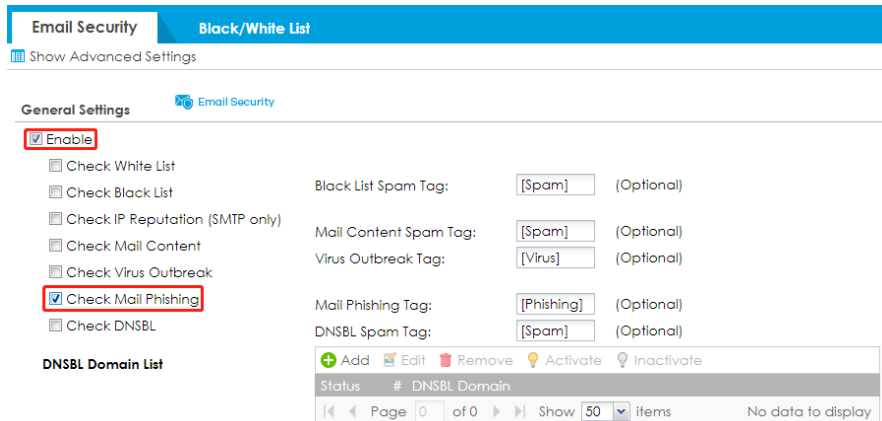

Figure 2 Phishing mail example

## Set up Phishing on ATP

In the ATP, Go to **Configuration > Security Service > Email Security** to enable Check Mail Phishing that allows gateway inspects the embed URLs in the email





## Test the Result

- 1 Go to **Monitor > Security Statistics > Email Security** to observe mail phishing logs

### Monitor > Security Statistics > Email Security

Time	Prior...	Category	Message	Source	Destination	Note
201...	info	Anti-Spam	SMTP Mail Phishing match, Rule_Id=1, Mail From:bbb@ssskkk.com.tw phishing host:websectest.ctmail.com	192.168.2.33:1766	192.168.22.1...	MAIL ...
201...	alert	AP Firmware	AP firmware synchronize cloud server failed.			
201...	error	myZyXEL.com	Skip get_time_zone, parameter missing!			
201...	notice	myZyXEL.com	GetTimeZone: Processing...			
201...	alert	AP Firmware	AP firmware synchronize cloud server failed.			
201...	info	DHCP	Sending ACK to 192.168.2.33			DHCP ...

- 2 Go to **Monitor > Security Statistics > Email Security** to collect Email security statistics

The screenshot shows the 'Status' tab of the Email Security configuration page. Under 'General Settings', the 'Collect Statistics' checkbox is checked. Below this are buttons for 'Apply', 'Reset', 'Refresh', and 'Flush Data'. The 'Email Summary' section displays various statistics, with 'Spam Mails Detected by Mail Phishing' highlighted in a red box and showing a value of 1. Other statistics like 'Total Mails Scanned' (1), 'Spam Mails' (0), and 'Virus Mails' (0) are also visible.

## What Can Go Wrong?

- 1 Make sure the Anti-Spam default service port is SMTP or POP3 by CLI  
**Router# show utm-manager anti-spam defaultport**

```
Router# show utm-manager anti-spam defaultport
No.      Proto      Port
-----
1        smtp       25
2        pop-3      110
```

- 2 It does not support SSL inspection.
- 3 The ATP can inspect email up to 50KB. If the mail size greater than 50KB, gateway will inspect the first 50KB from the header

## How to setup Email to SMS

The Email to SMS function can help to send the SMS to client. The SMS message is initiated from device to SMS provider, and then SMS provider send the SMS to client. This function can help to make sure user receives SMS if client without Internet connection.

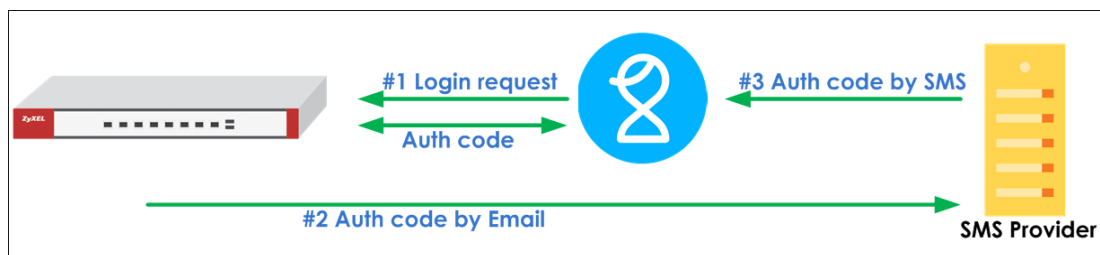

You can follow these steps to Email to SMS.

### Setup SMTP function on your device

Go to **CONFIGURATION > System > Notification > Mail Server** Field your SMTP server configuration.

- A. Mail server
- B. Mail server ports
- C. Mail From
- D. SMTP Authentication

Mail Server
SMS

---

**General Settings**

Mail Server:  (Outgoing SMTP Server Name or IP Address)

Mail Subject:  Append system name  Append date time

Mail Server Port:   TLS Security  STARTTLS  Authenticate Server

Mail From:  (Email Address)

SMTP Authentication

User Name :

Password:

Retype to Confirm:

---

**Schedule**

Time For Sending Report:  (hours)  (minutes)

 Note: Must make sure SMTP Server configuration is correct otherwise message will unable send to SMS provider successfully.

## Setup Email to SMS Provider configuration

Go to **“Configuration > system > Notification > SMS Select “SMS Provider”** as Email to SMS Provider. Enter SMS Provider Email server domain name.

And configuring sender mail address in **“Mail From”**

Mail Server
SMS

---

**General Settings**

Enable SMS

Default country code for phone number:  (1-4) digit

SMS Provider:  

Provider Domain:  **SMS Provider Email domain**  auto append to "Mail to" (Optional)

Mail Subject:  (Optional)

Mail From:  **Email address** (Optional)

Mail To:  @email.smsglobal.com

**Note**

1. If you select to use an Email-to-SMS provider, configure a mail server before you enable SMS.
2. If you leave the Mail From field blank here, the system automatically uses the mail address configured in the Mail Server screen.
3. "Mail To" default format is "\$mobile\_number\$@provider domain" and some Service Providers might require prefix symbol like "+" added before \$mobile\_number\$.

 Note: Your SMS provider has to allow the email address which configured in **“Mail From”** to prevent the email is denied by SMS provider's mailbox.

## Create admin type user on device

Go to **Configuration > Object > User/Group > User** Click Add button to create an user and user type is admin. And also entered phone number of this user.

**Edit User stanley**

**User Configuration**

User Name : stanley

User Type: admin

Password: .....

Retype: .....

Description: Local User

Email:

Mobile Number: +88. 31

Authentication Timeout Settings

Use Default Settings  Use Manual Settings

Lease Time: 1440 minutes

Reauthentication Time: 1440 minutes

## Setup Two-Factor Authentication for admin on your device

Go to **Configuration > Object > Auth Method > Two-Factor Authentication > Admin Access**

Enable the function and add admin user which you added in step3 in the rule, and you can select what services are 2 Factor authentication needed. Enable SMS function to send verification code by SMS.

**Authentication Method** Two-factor Authentication

VPN Access Admin Access

**General Settings**

Enable

Valid Time:  (1-5 minutes)

Two-factor Authentication for Services:

Web  SSH  TELNET

**User**

Selectable User Objects

=== Object ===

admin

Selectable User Objects

=== Object ===

stanley

**Delivery Settings**

Deliver Authorize Link Method:  SMS  Email

## Test the Result

After setup these steps and login to device by admin user, the verification code is required.

### Web Service:

**ZYXEL**

**ATP500**

Enter Two-factor Authentication Verification code and click to verify.

Verify

### SSH Service:

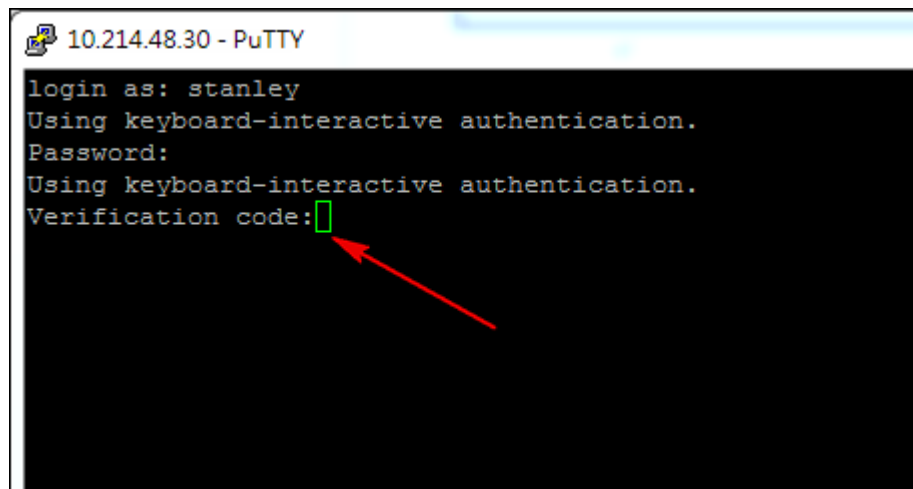

You will receive verification code by SMS.

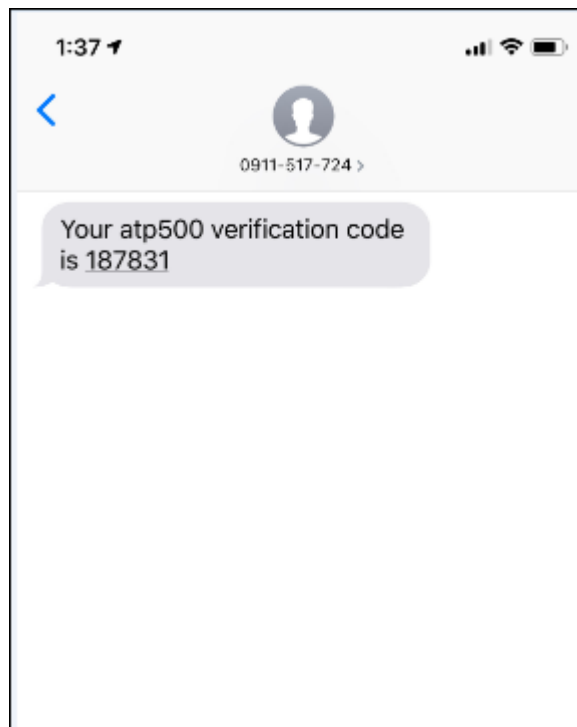

## What Can Go Wrong?

- 1 Must make sure SMTP server configuration is correct.
- 2 Must make sure your SMS provider is supported Mail to SMS function.
- 3 Make sure your email address is allowed by your SMS provider.



## How to Use IP Reputation to Detect Threats

**(This feature is only supported on ATP series)**

As cyber threats such as scanners, botnets, phishing, etc. grow increasingly, how to identify suspect IP addresses of threats efficiently becomes a crucial task.

With regularly updated IP database, ATP prevents threats by blocking connection to/from known IP addresses based on signature database. It filters source and destination addresses in your network traffic to take the proper risk prevention actions.

This example illustrates how to configure IP Reputation on ATP gateway to detect cyber threats for both incoming and outgoing traffic.

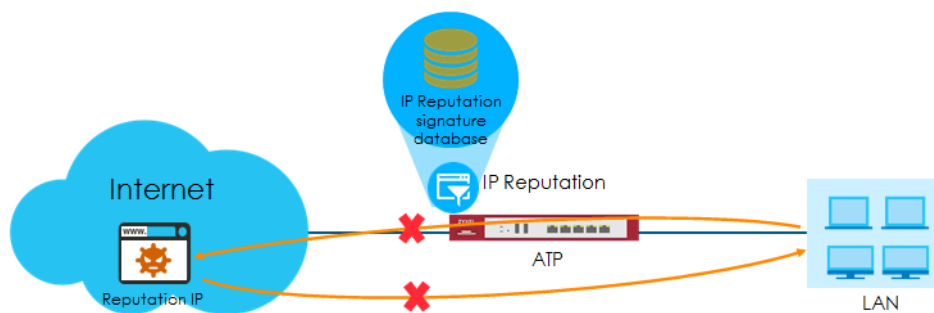

**Figure**

 Note: All network IP addresses and subnet masks are used as examples in this article. Please replace them with your actual network IP addresses. This example was tested using the ATP500 (Firmware Version: ZLD 4.35).

## Activating Reputation Filter Service

- 1 Register ATP gateway to myZyxel.com.
- 2 Activate Reputation Filter license.

#	Service	Status	Service Type	Expiration Date	Count	Action
1	Web Security	Activated	Standard	2020-3-31	N/A	<a href="#">Renew</a>
2	Application Security	Activated	Standard	2020-3-31	N/A	<a href="#">Renew</a>
3	Malware Blocker	Activated	Standard	2020-3-31	N/A	<a href="#">Renew</a>
4	Intrusion Prevention	Activated	Standard	2020-3-31	N/A	<a href="#">Renew</a>
5	Geo Enforcer	Activated	Standard	2020-3-31	N/A	<a href="#">Renew</a>
6	Sandboxing	Activated	Standard	2020-3-31	N/A	<a href="#">Renew</a>
7	Reputation Filter	Activated	Standard	2020-3-31	N/A	<a href="#">Renew</a>
8	SecuReporter	Activated	Standard	2020-3-31	N/A	<a href="#">Renew</a>
9	Managed AP Service	Activated	Standard	2020-3-31	34	<a href="#">Renew</a>
10	Device HA Pro	Activated	Standard		N/A	
11	Firmware Upgrade Service	Activated			N/A	

Page 1 of 1 Show 50 items Displaying 1 - 11 of 11

- 3 On ATP, go to **CONFIGURATION > Licensing > Signature Update**. Click the **Update** icon to check for new signatures.

Feature	Type	Current Version	Released Date	Last Sync	Action
Anti-Malware	Anti-Malware Signature	2.0.2.20190601.0	2019-06-01 09:35:37 (UTC+08:00)		
	Cloud Threat Databa...	1.0.0.20190601.0	2019-06-01 02:15:03 (UTC+08:00)	2019-06-13 23:49:01	
App-Patrol	App-Patrol	1.0.0.20190516.0	2019-05-16 09:45:23 (UTC+08:00)	2019-06-02 00:15:01	
IDP	IDP	4.0.0.20190524.0	2019-05-24 10:10:00 (UTC+08:00)	2019-06-02 01:53:01	
Botnet Filter	Botnet Filter	1.0.0.20190601.0	2019-06-01 10:20:50 (UTC+08:00)	2019-06-14 02:50:01	
IP Reputation	IP Reputation	1.0.0.20190601.0	2019-06-01 10:30:10 (UTC+08:00)	2019-06-17 14:56:03	

## Enabling IP Blocking on ATP

Go to **CONFIGURATION > Security Service > Reputation Filter > IP Reputation > General**. Click **Enable** to detect reputation IPs. The threat level threshold is measured by the query score of IP signature database.

General	White List	Black List
<b>IP Blocking</b>		
<input checked="" type="checkbox"/> <b>Enable</b>		
Action:	block	
Threat Level Threshold:	high	High Medium and above Low and above
Log:	log	

## Selecting specific type of IP addresses to block

In Types of Cyber Threats Coming From The Internet, select the type of threats that are known to pose a security threat for incoming traffic.

In Types of Cyber Threats Coming From The Internet And Local Networks, select the type of threats that are known to pose a security threat for both incoming and outgoing traffic.

Types of Cyber Threats Coming From The Internet		
<input checked="" type="checkbox"/> Anonymous Proxies	<input checked="" type="checkbox"/> Denial of Service	<input checked="" type="checkbox"/> Exploits
<input checked="" type="checkbox"/> Negative Reputation	<input checked="" type="checkbox"/> Scanners	<input checked="" type="checkbox"/> Spam Sources
<input checked="" type="checkbox"/> TOR Proxies	<input checked="" type="checkbox"/> Web Attacks	
Types of Cyber Threats Coming From The Internet And Local Networks		
<input checked="" type="checkbox"/> Botnets	<input checked="" type="checkbox"/> Phishing	
Test IP Threat Category		
IP to test:	<input type="text"/>	<input type="button" value="Query"/>
Signature Information		
Current Version:	1.0.0.20190601.0	
Signature Number:	752104	
Released Date:	2019-06-01 10:30:10	
	<a href="#">Update Signatures</a>	

## Adding IP addresses to white list and black list

Go to **CONFIGURATION > Security Service > Reputation Filter > IP Reputation > White List** and **Black List** to manually adding IP addresses to the White List and Black List.

General **White List** Black List

**White List**

Check White List

+ Add Edit Remove Activate Inactivate

#	Status	IPv4 Address
1		1.1.1.1

Page 1 of 1 Show 50 items Displaying 1 - 1 of 1

General White List **Black List**

**Black List**

Check Black List

+ Add Edit Remove Activate Inactivate

#	Status	IPv4 Address
1		9.9.9.9

Page 1 of 1 Show 50 items Displaying 1 - 1 of 1

## Monitoring statistics for IP detection

Enable Collect Statistics to monitor the scanned result and detected IP.

### MONITOR > Security Statistics > Reputation Filter

**General Settings**

Collect Statistics since 2019-06-18 13:30:56 to 2019-06-18 13:30:56

Refresh Flush Data

**Summary**

IP Scanned: 0  
 IP Hit Count: 0  
 URL Scanned: 0  
 URL Hit Count: 0

**IP Detected**

+ Add to white list - Remove from white list

Time	Malicious IP	Infected/Victim Host	Threat Category	Threat Level
No data to display				

Page 0 of 0 Show 50 items

**URL Detected**

+ Add to white list - Remove from white list

Time	Source IP	Destination IP	Botnet URL	Threat Category
No data to display				

Page 0 of 0 Show 50 items

## Test the Result

- 1 Select Anonymous Proxies for detecting incoming traffic and Botnet for outgoing traffic.

**IP Blocking**

Enable

Action:

Threat Level Threshold:

Log:

**Types of Cyber Threats Coming From The Internet**

Anonymous Proxies       Denial of Service       Exploits

Negative Reputation       Scanners       Spam Sources

TOR Proxies       Web Attacks

**Types of Cyber Threats Coming From The Internet And Local Networks**

Botnets       Phishing

- For incoming traffic, set a NAT rule and add a security policy rule for allowing traffic from WAN to LAN.

**General Settings**

Enable Policy Control

**IPv4 Configuration**

Allow Asymmetrical Route

Pr...	St...	Name	From	To	IPv4 Sou...	IPv4 Des...	Service	User	Schedule	Action	Log	Profile
1		test	WAN	LAN	any	any	RDP	any	none	allow	no	
2		LAN_Outgoing	LAN	any (Ex...	any	any	any	any	none	allow	no	
3		DMZ_to_WAN	DMZ	WAN	any	any	any	any	none	allow	no	

For outgoing traffic, ping an IP address in the threat category "Botnets" from LAN.

- Check statistics for detected IPs.

## MONITOR > Security Statistics > Reputation Filter

**General Settings**

Collect Statistics since 2019-06-17 16:16:48 to 2019-06-17 16:23:50

**Summary**

IP Scanned: 197

IP Hit Count: 7

URL Scanned: 0

URL Hit Count: 0

**IP Detected**

Time	Malicious IP	Infected/Victim Host	Threat Category	Threat Level
2019/06/17 16:23:33	<input type="checkbox"/> 195.20.42.1	192.168.1.33	BotNets	High
2019/06/17 16:23:32	<input type="checkbox"/> 195.20.42.1	192.168.1.33	BotNets	High
2019/06/17 16:23:00	<input type="checkbox"/> 195.20.42.1	192.168.1.33	BotNets	High
2019/06/17 16:22:59	<input type="checkbox"/> 195.20.42.1	192.168.1.33	BotNets	High
2019/06/17 16:21:45	<input type="checkbox"/> 148.251.232.132	192.168.1.34	Anonymous Proxies	High
2019/06/17 16:21:45	<input type="checkbox"/> 148.251.232.132	192.168.1.34	Anonymous Proxies	High
2019/06/17 16:21:44	<input type="checkbox"/> 148.251.232.132	192.168.1.34	Anonymous Proxies	High

On dashboard, you can find top 5 countries that are detected the most by IP Reputation.

## Dashboard > Advanced Threat Protection

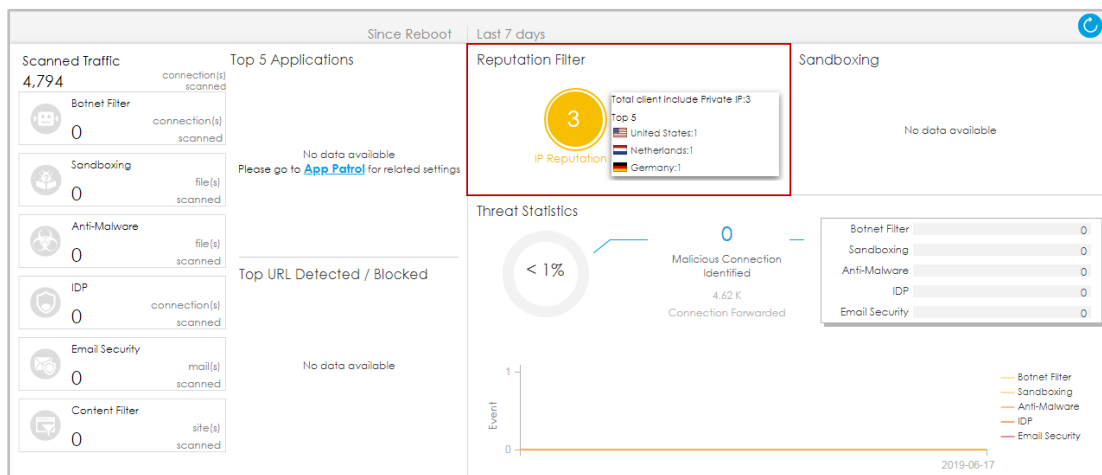

## What Can Go Wrong?

1. For device HA or HA Pro, signature synchronization is required.
2. Cloud query is not supported.
3. It doesn't support for IPv6.