



Ruijie RG-EG3230 Gateway

Hardware Installation and Reference Guide V1.0

Copyright Statement

Ruijie Networks©2020

Ruijie Networks reserves all copyrights of this document. Any reproduction, excerption, backup, modification, transmission, translation or commercial use of this document or any portion of this document, in any form or by any means, without the prior written consent of Ruijie Networks is prohibited.

Exemption Statement

This document is provided “as is”. The contents of this document are subject to change without any notice. Please obtain the latest information through the Ruijie Networks website. Ruijie Networks endeavors to ensure content accuracy and will not shoulder any responsibility for losses and damages caused due to content omissions, inaccuracies or errors.

Preface

Thank you for using our products. This manual will guide you through the installation of the device.

This manual describes the functional and physical features and provides the device installation steps, hardware troubleshooting, module technical specifications, and specifications and usage guidelines for cables and connectors.

Audience

It is intended for the users who have some experience in installing and maintaining network hardware. At the same time, it is assumed that the users are already familiar with the related terms and concepts.

Obtaining Technical Assistance

- Ruijie Networks Website: <https://www.ruijienetworks.com/>
- Technical Support Website: <https://ruijienetworks.com/support>
- Case Portal: <https://caseportal.ruijienetworks.com>
- Community: <https://community.ruijienetworks.com>
- Technical Support Email: service_rj@ruijienetworks.com
- Skype: [service_rj@ruijienetworks.com](https://www.skype.com/people/service_rj@ruijienetworks.com)

Related Documents

Documents	Description
Configuration Guide	Describes network protocols and related mechanisms that supported by the product, with configuration examples.
Command Reference	Describes the related configuration commands, including command modes, parameter descriptions, usage guides, and related examples.

Symbol Conventions

 Means reader take note. Notes contain helpful suggestions or references.

 Means reader be careful. In this situation, you might do something that could result in equipment damage or loss of data.

1 Product Overview

Ruijie RG-EG3230 gateway employs the global-leading semiconductor technologies and communication control technologies, and is an independently developed data communication product of Ruijie Networks with independent intellectual property right. The gateway products of Ruijie are completely developed as per international standards and are similar to the mainstream gateway products in the international market. By reading this manual, network administrator being familiar with mainstream gateway configuration commands can easily use this product without training.

1.1 Ruijie RG-EG3230 Gateway

1.1.1 Ruijie RG-EG3230 Gateway

Appearance of Ruijie RG-EG3230 Gateway

Figure 1-1 Front Panel of Ruijie RG-EG3230 Gateway

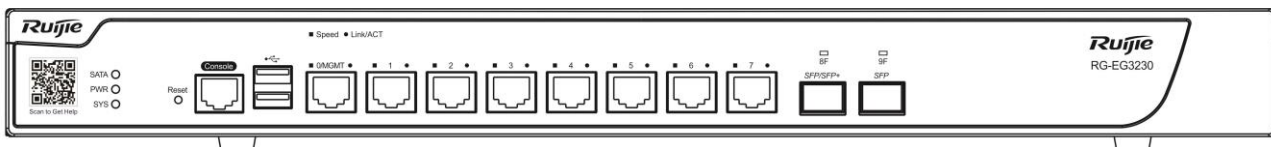
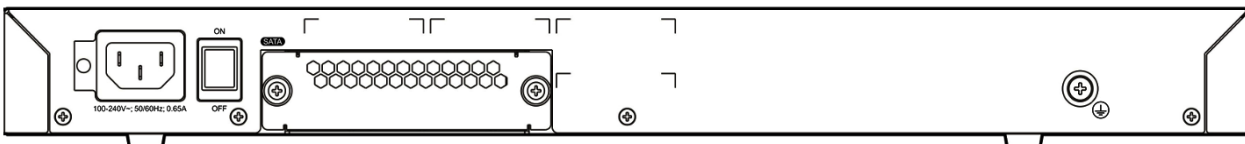



Figure 1-2 Backpanel of Ruijie RG-EG3230 Gateway



Specifications of Ruijie RG-EG3230 Gateway

Table 1-1 Specifications of Ruijie RG-EG3230 Gateway

Item	Description
Storage	DDR4 SDRAM: 2 GB
	BOOTROM: 8 MB
	eMMC: 8 GB
	SATA: 1 TB
I/O Setup	Supports 8 Gigabit copper ports, 1 Gigabit fiber port, and 1 tenGigabit fiber port. All of them support WAN/LAN switchover. By default, port 6, 7, 9 are WAN ports, while the port 0, 1, 2, 3, 4, 5, 8 are LAN ports.
	The Gigabit copper ports are 10/100/1000 M adaptive and support automatic recognition of the network cables and the cross-over cables. One management port, which is the GE 0/0 combo port. The MGMT port supports 10/100/1000 M adaptive and automatic recognition of the network cables and the cross-over cables.

	One console port
	Two USB2.0 ports
SFP Module	See <i>Appendix B</i> . The copper cable is not supported.  The supported module type may change at any time. Consult Ruijie Networks for the latest information.
SFP Port	1000Base-X 100Base-X
SFP+ Port	1000Base-X 10GBase-X
BYPASS	Not supported
Hardware Disk Module	One 1TB hardware disk is provided.
Expansion Module	Not supported
Hot Swapping	Hard disk hot swapping is not supported.
Interface Standard	Ethernet: 10Base-T/100Base-TX/1000Base-TX, 1000BASE-SX/LX/ZX, 10GBASE-SR/LR/ZR
	Console port: RS-232
Dimension (W x H x D)	440 mm x 43.6 mm x 200 mm (excluding the foot pad)
Voltage	100VAC to 240VAC; 50/60 Hz, 0.65A
Power Consumption	Less than 25 W
Working Environment	Temperature: 0°C to 45°C (32°F to 113°F)
	Humidity: 10% to 90% RH (non-condensing)

 Not all USB disks are supported. The Kingston USB disk with FAT 32 is recommended.

 Please avoid the vibration and collision in the process of moving and usage.

 Products should be transported in original packets.

 Format a hardware disk to `.EXT3` before installing it.

 To power off the device, please turn off the power button. Do not remove the power cable until the PWR led turns off, or else the hardware disk will be damaged.

 The 10GE fiber port does not support the direct connection between two EG3200 devices via the SFP module or fiber cables.

LED Indicators of Ruijie RG-EG3230 Gateway

Table 1-2 LED Indicators of Ruijie RG-EG3230 Gateway

LED Indicators	Working Status
PWR	Solid green indicates the device is receiving power properly. Off indicates the power module is faulty or not powered on.
SYS	Blinking green indicates the system is being initialized. Solid green indicates system initialization has completed. Solid red indicates system warning.











SATA	Solid green indicates the SATA hard disk is inserted. Blinking green indicates data reading/writing.
Link/ACT Indicators of 0-7 Copper Ports	Solid green indicates that the port is connected at 10/100/1000 Mbps. Blinking green indicates that the port is receiving or transmitting traffic at 10/100/1000 Mbps.
Speed Indicators of 0-7 Copper Ports	Solid orange indicates that the port is connected at 1000 Mbps. Off indicates that the port is connected at 10/100 Mbps.
Indicators of 8F-9F SFP Ports	Solid green indicates that the port is connected. Blinking green indicates that the port is receiving or transmitting traffic.

2 Preparations before Installation

2.1 Safety Precautions

The gateway acts as the critical transfer station of network connections, and its normal service is crucial to the normal operation of the entire network.

The following safety suggestions are applicable to the installation and use of the gateway:

- Do not place the device in a watery place and prevent any liquid from entering into it.
 - Keep the device away from heat sources.
 - Ensure the normal grounding of device.
 - Wear an anti-static wrist strap to install and maintain the device.
 - Do not wear loose clothes to avoid hooking any parts. Before operation, tighten your band, shawl and sleeves.
 - Keep tools and parts away from the walkway to avoid damage.
 - Use the uninterruptible power supply (UPS) to avoid power failure and other interferences.
 - If the system time is incorrect, check whether you have set the clock. If the clock is not set, the time may not be correct; if the clock has been set precisely and the time is still incorrect, the built-in button cell of device may have ran out, which is typically happened after 10-year service.
 - Install the power outlet close to the device in order to turn off the power quickly.
-
-  Use of wrong battery may cause damage to the device. Do not replace the battery by yourself. Please contact the Technical Assistance Center of Ruijie Networks for help.
 -  This is a Class-A product which may cause radio interference in the living environment. In such a case, the user may need to take feasible measures against such interference.
 -  Install and use the device in restricted access locations.
 -  Invite professionals and related technicians to install this type of device.
-
-  Where a plug on the power supply cord is used as the disconnect device, the installation instructions shall state that for pluggable equipment, the socket-outlet shall be easily accessible. For pluggable equipment intended for installation by an ordinary person, the installation instructions shall be made available to the ordinary person.
 -  "Do not ingest battery, Chemical Burn Hazard"
 -  This product contains a coin / button cell battery. If the coin / button cell battery is swallowed, it can cause severe internal burns in just 2 hours and can lead to death.
 -  Keep new and used batteries away from children.
 -  If the battery compartment does not close securely, stop using the product and keep it away from children.
 -  If you think batteries might have been swallowed or placed inside any part of the body, seek immediate medical attention.
-

2.2 Requirements on Installation Environment

Ruijie RG-EG3230 gateway products are for indoor use only. To ensure normal operation and prolong their service life, the installation site must meet the following requirements:

Temperature/humidity requirements

- Cleanliness requirements
- Anti-static requirements
- Anti-interference requirements
- Lightning protection requirements
- Checking the installation location

2.2.1 Temperature/Humidity Requirements

To ensure normal operation and prolong the service life of the device, the equipment room must maintain constant temperature and humidity. If the equipment room is overheated for a long time, the insulation materials may result in defective insulation and even electric leakage. If the relative humidity is low, the insulation spacer may result in dry shrinkage, which will make screws looser and easily generate static electricity in the dry environment, thus damaging the interior circuits on the device. Excessively high temperature will accelerate the aging of insulation materials and compromise the reliability and even service life of the device. The temperature/humidity requirements are shown below (detailed difference between products is described in the chapter of "Product Overview"):

- Table 2-1 Temperature and Humidity Requirements of Ruijie RG-EG3230 Gateways

Temperature	Relative Humidity
0°C to 45°C/ 32°F to 113°F	10% to 90%

-  The working temperature/humidity indicates the value measured at 1.5 m above the floor and 0.4 m ahead of the equipment frame when there is no protection plate on the front and rear side of the equipment frame.

2.2.2 Cleanliness Requirements

The dust is also a major threat to the safe operation of device. The dust accumulated on the device may cause electrostatic adsorption and result in poor contact. It will not only compromise the service life of device but also cause communication failure. When the indoor relative humidity is low, such electrostatic adsorption will incur more easily.

- Table 2-2 The Equipment Room Dust Content and Particle Size Requirements of Ruijie RG-EG3230 Gateways

Maximum Diameter (μm)	0.5	1	3	5
Maximum Density (Particles/m ³)	1.4 x 10 ⁷	7 x 10 ⁵	2.4 x 10 ⁵	1.3 x 10 ⁵

Apart from the dust, the device is also sensitive to the hydrochloric acid sulfide contained in the air. These noxious gases will accelerate metal wastage and the aging of certain parts. The upper limits of noxious gases (Sulfur dioxide, Sulfured hydrogen, Nitrogen dioxide, Ammonia and Chlorine) in the equipment room are shown in Table 2-3:

- Table 2-3 Upper Limits of Noxious Gases of Ruijie RG-EG3230 Gateways

Gas	Average (mg/m ³)	Maximum (mg/m ³)
-----	------------------------------	------------------------------

Gas	Average (mg/m ³)	Maximum (mg/m ³)
Sulfur dioxide	0.2	1.5
Sulfured hydrogen	0.006	0.03
Nitrogen dioxide	0.04	0.15
Ammonia	0.05	0.15
Chlorine	0.01	0.3

2.2.3 Anti-Static Requirements

The gateway has already given consideration to electrostatic prevention during circuit design, but excessively strong static electricity will still damage the circuit board. The static electricity in the communication network connected with the device is mainly from:

- Outdoor high-voltage transmission line, lightning and other exterior electric fields.
- Indoor environment, flooring material, complete appliance structure and other in-house systems.

To avoid the damage caused by static electricity, we shall:

- Properly ground the device and floor;
- Apply indoor dust control;
- Maintain proper temperature and humidity;

Pay attention to the following for modules or circuit boards which can be disassembled by the user:

- Before touching the circuit board, wear an anti-static wrist strap and an anti-static uniform;
- Place the circuit board disassembled face up on the antistatic workbench or in the electromagnetic shielded bag.
- When observing or transferring the circuit board of gateway, touch the outer edge of circuit board and avoid direct contact with the components on the circuit board.

2.2.4 Anti-Interference Requirements

The interference as mentioned herein refers to electromagnetic or electrical interference, and the anti-interference requirements are described below:

- Effective power grid interference control measures shall be taken against the power supply system.
- The working ground of the gateway shall be kept far away from the grounding device or lightning grounding device of power equipment instead of sharing.
- The gateway shall be kept far away from high-power radio-transmitting station, radar-transmitting station and other high-frequency & heavy-current devices.
- Electromagnetic shielding measures shall be taken whenever necessary.

2.2.5 Checking the Installation Location

No matter the gateway is installed in the cabinet or on the workbench, the following requirements shall be met:

- Make sure sufficient room has been reserved for the air intake and air vent of gateway to facilitate the heat elimination of the gateway chassis. It is recommended to install the gateway in the 19-inch standard cabinet. Otherwise, install it on a clean and flat surface. In heated areas, the air conditioning system shall be equipped.

- Make sure the cabinet and workbench is equipped with a good ventilation and cooling system.
- Make sure the cabinet and workbench is steady enough and capable of withstanding the weight of the gateway and its accessories.
- Make sure the cabinet and workbench is properly grounded.

2.3 Installation Tools and Devices

To enable smooth installation, prepare the following items:

- Installation tools
- Connecting cables
- Related devices

Installation tools include:

- Phillips screwdriver
- Anti-static wrist strap

Connection cables include:

- Power cables
- Configuration cables
- Ethernet cables
- Grounding wires

Related devices include:

- HUB or switch
- Configuration terminal (PC with hyper-terminal)
- Electric outlet

3 Installing the Gateway

3.1 Installation Procedure of Gateway

To avoid the damage of gateway caused by rush or mal-operation during the installation process, install the device as per the following steps shown in Figure 3-1.

Figure 3-1 Device Installation Procedure

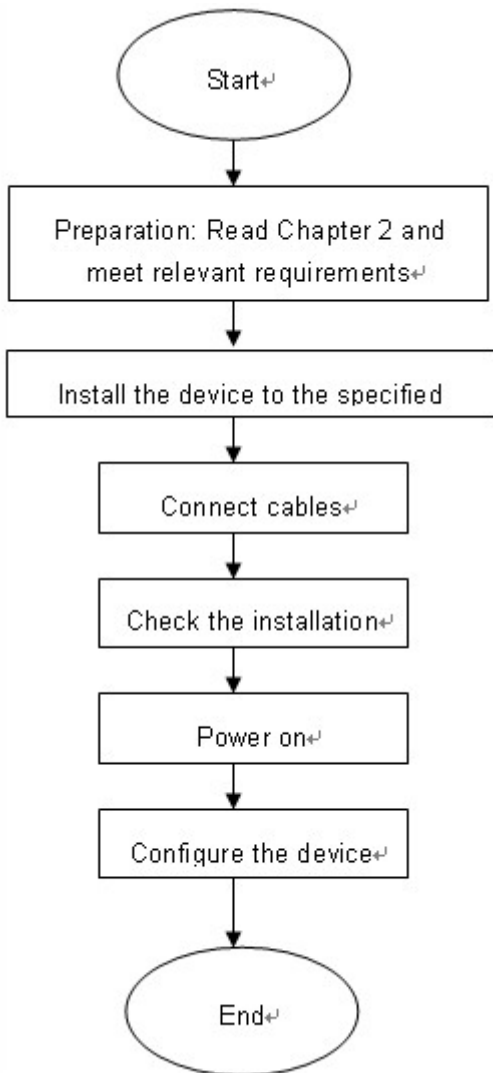

3.2 Mounting the Gateway

Mounting the gateway refers to installing the device to the specified position. Upon completion of installation preparation, fix the gateway to the specified position. The installation position of gateway is generally a cabinet or a workbench.

3.2.1 Mounting into a Cabinet

Ruijie gateway products are designed based on the dimension of a standard cabinet. You can install the device with the enclosed fixing accessories.

3.2.2 Mounting on a Workbench

In most cases, the user does not have a standard cabinet. Instead, the user can place the device on a clean workbench. Although it is easy and simple, you shall pay attention to the following:

- Guarantee the steadiness and good grounding of the workbench;
- Stick the attached plastic pads onto the small holes at the bottom of the gateway, and reserve a heat elimination room of at least 10 cm around the device.
- Do not place heavy things on the device.

3.3 Installing Power Cables

The requirements of Ruijie RG-EG3230 gateway products on AC power supply are described below (refer to the section of “Product Overview” for detailed parameters):

100–240 V / 50/60 Hz

Make sure your power supply meets the requirement.

The gateway uses 3-conductor power cables. You are suggested to use a single-phase 3-conductor outlet or a multifunction microcomputer outlet with neutral connector. The neutral point of the power supply shall be securely grounded in the building. In most buildings, the neutral point of a power supply has been grounded during the construction. You need to make sure the power supply is properly grounded.

Install power cables as per the following steps:

1. Plug one end of the power cable into the power port on the backpanel of a gateway, and plug the other end into the AC power supply outlet.
2. Check whether the power LED on the front panel of the gateway lights up or not. The LED indicator will light up if the power supply is properly connected.

3.4 EMC Grounding

The grounding required for EMC design includes shielding ground, filter ground, noise and interference suppression, and level reference. All the above constitute the comprehensive grounding requirements. The grounding resistance should be less than 1 ohm. The RG-EG3230 devices are equipped with a grounding pole at the rear panel, as shown in Figure 3-2.

Figure 3-2 Schematic Diagram of Grounding of the RG-EG3230 Devices

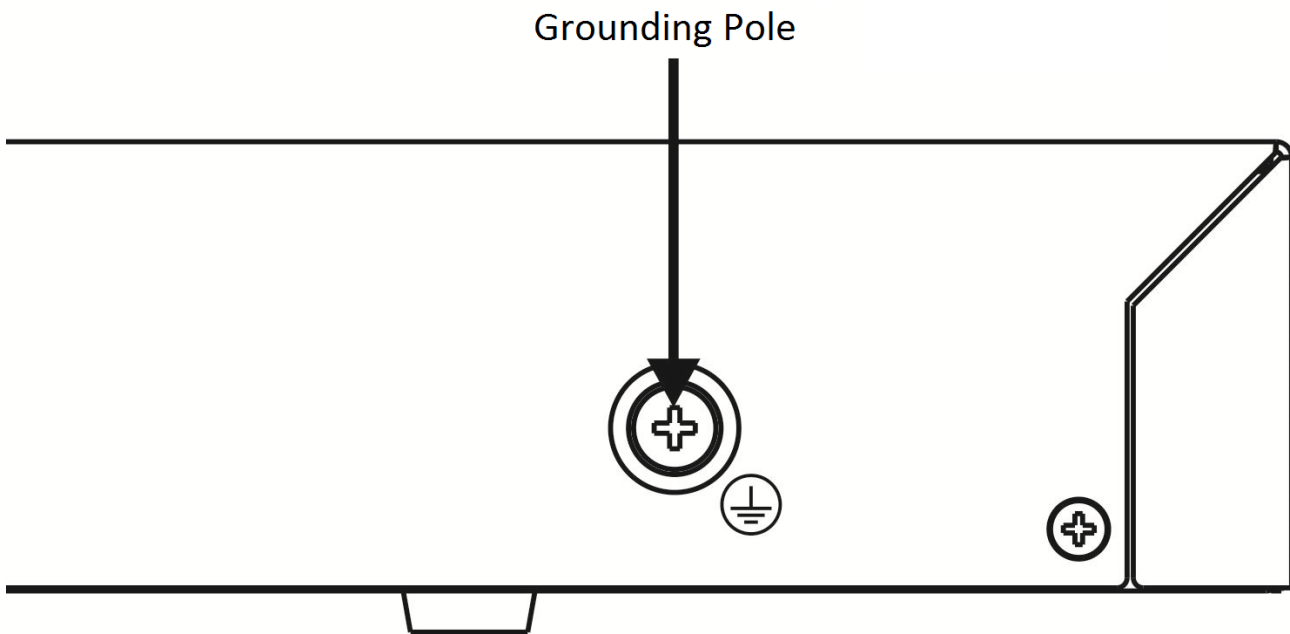

3.5 Connecting Console

Ruijie RG-EG3230 gateway provides an EIA/TIA-232 asynchronous serial console port, through which the user can complete the local configuration of the gateway. The attributes of a console are shown in Table 3-1. In case of WEB based configuration, the console port will be of no use.

Table 3-1 Attributes of the Console Connection

Parameter	Description
Connector	RJ-45
Interface Standard	Asynchronous EIA/TIA-232
Baud Rate	Supporting 9600 bps (default), 57600 bps and 115200 bps
Services Supported	<ol style="list-style-type: none"> 1. Command line interface 2. Connection with character terminal 3. Provision of terminal access service as an asynchronous interface

You can configure the console port of a gateway based on the following steps:

Connect one end of the enclosed configuration cable to the console port of device and the other end to the DB-9 male interface of the microcomputer used for configuring the device.

3.6 Checking after the Installation

After completing the mechanical installation of gateway, perform the following checks before powering on the device:

- If the device is installed in a cabinet, check whether the angle bar for device installation is steady. If the device is installed on the workbench, check whether sufficient room is reserved around the device to ensure heat elimination and whether the workbench is steady.
- Check whether the power supply meets the requirements.

- Check whether the earth wire of device is properly connected.
- Check whether the device is connected correctly to other devices like the configuration terminal.

4 Starting and Configuring the Gateway

4.1 Starting a Gateway

4.1.1 Building Configuration Environment

When the gateway is used for the first time, you must configure the gateway via the console port as follows:

Step 1: Connect the serial port of a character terminal or a microcomputer to the console port (or configuration port or control panel port) of a gateway via a standard RS232 cable.

Step 2: Configure the communication parameters of the terminal. If you use a microcomputer, you need to run the terminal emulator like the Hyperterm program provided by Windows operating system. We will describe the operating procedures by taking the example of Hyperterm.

Run Hyperterm software and establish a new connection, as shown in Figure 4-1;

Select the serial port connecting with the console port of the gateway, as shown in Figure 4-2;

Configure the communication parameters: 9600 baud rate, 8-bit data bits, 1-bit stop bit, no parity check, and no flow control, as shown in Figure 4-3;

Choose **File > Attribute > Setting** and select the terminal emulation type of VT100; all as shown in Figure 4-4:

- Figure 4-1 Establish a New Connection

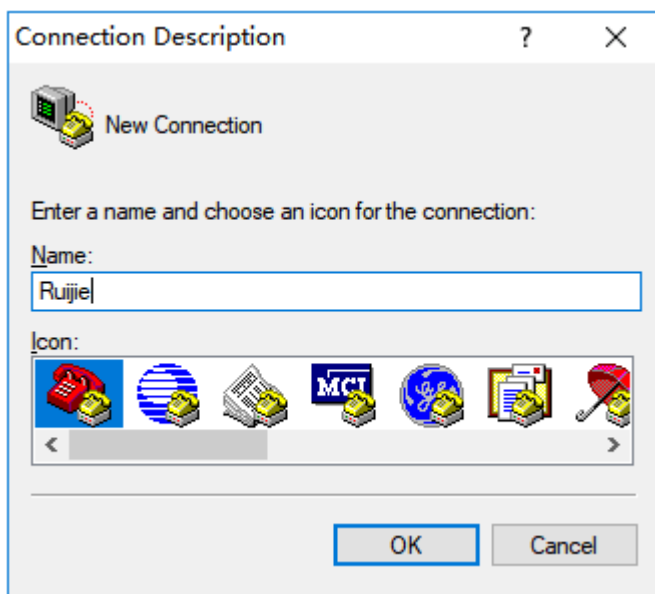

Figure 4-2 Select the Serial Port of Microcomputer Connecting with the Console Port of Gateway

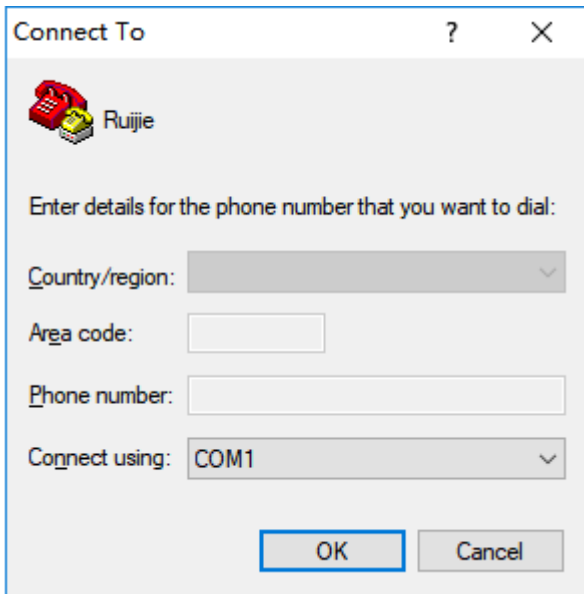

Figure 4-3 Configure the Communication Parameters of the Serial Port

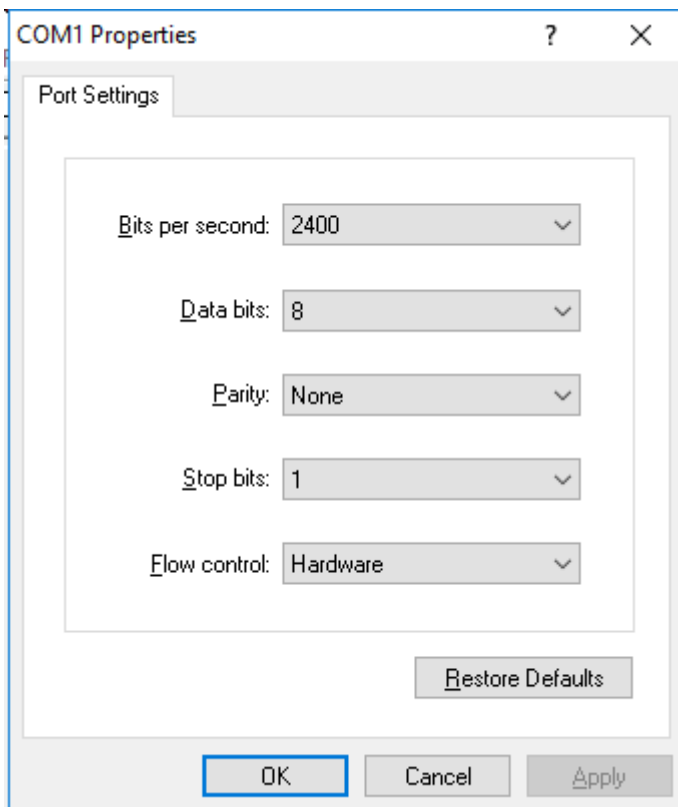
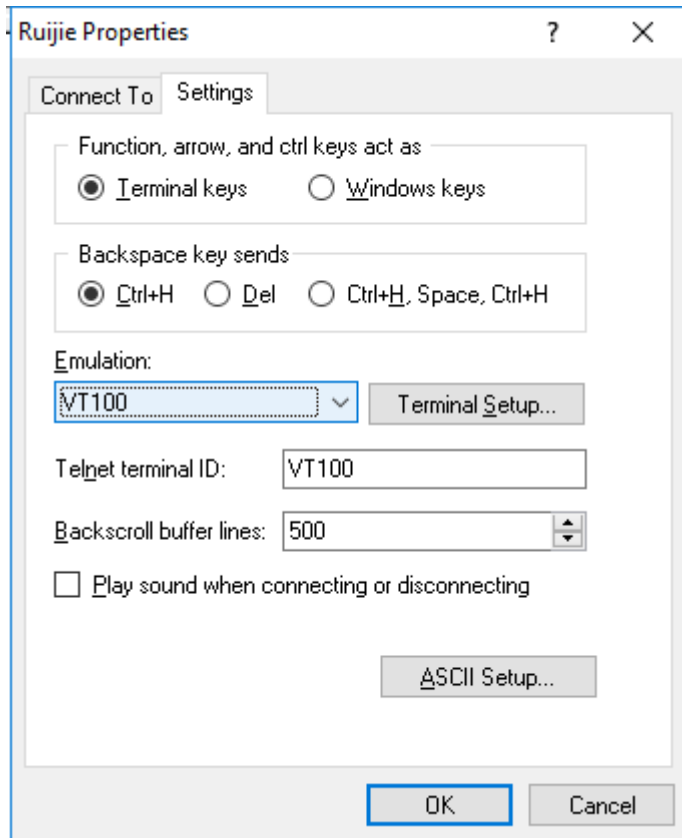

Figure 4-4 Select the Terminal Emulation Type



After building the configuration environment, you can then power on the gateway.

4.1.2 Powering on the Gateway

Checks before Power-on

Before power-on, perform the following checks on the gateway:

- Whether the power cable and the ground wire are properly connected;
- Whether the power voltage is consistent with the requirement of the gateway.
- Whether the configuration cable is properly connected, and whether the microcomputer or terminal for gateway configuration is started or configured.



Before powering on the gateway, be aware of the location of the power switch of the gateway to timely cut off power supply in case of any accident.

Powering on the Gateway

- Turn on the power supply switch of the gateway
- Turn on the power switch of the gateway and set the power switch to "ON" position.

Checks after Power-on

After the gateway is powered on, check the following items:

- Whether the ventilation system works normally

Checking procedure: After power-on, you can hear the fan working; put your hand nearby the vent hole of gateway to feel the airflow.

- Whether the LED indicators on the front panel of the gateway works normally.

Checking procedure: Refer to the section of indicators description about each product in the first chapter “Product Overview”.

- Whether the configuration terminal displays normally

Checking procedure: After the gateway is powered on, the terminal will display the software loading information of the gateway.

4.1.3 Starting Process

The following information will be displayed when the gateway is started for the first time:



```
*****
System bootstrap ...
Boot Version: RGOS 10.3(4), Release(53498)
Nor Flash ID: 0x00010049, SIZE: 2097152Bytes
MTD_DRIVER-5-MTD_NAND_FOUND: 1 NAND chips(chip size : 33554432) detected
MTD_DRIVER-5-MTD_NAND_FOUND: 1 nand chip(s) found on the target.
Press Ctrl+C to enter Boot Menu .....
Main Program File Name rgos.bin, Load Main Program ...

Executing program, launch at: 0x00010000
Ruijie General Operating System Software
Release Software (tm), RGOS 10.3(4), Release(53498), Compiled Fri Apr  3 08:45:59 CST 2009 by ngcf31

Copyright (c) 1998-2009 by Ruijie Networks.
All Rights Reserved.
Decompiling or Reverse Engineering is Not Allowed.

00:00:00:00: %MTD_DRIVER-5-MTD_NAND_FOUND: 1 NAND chips(chip size : 33554432) detected
00:00:00:00: %MTD_DRIVER-5-MTD_NAND_FOUND: 1 nand chip(s) found on the target.
00:00:00:17: %LINK-5-CHANGED: Interface FastEthernet 0/1, changed state to up
00:00:00:17: %LINEPROTO-5-UPDOWN: Line protocol on Interface FastEthernet 0/1, changed state to up
00:00:00:17: %LINK-5-CHANGED: Interface FastEthernet 0/0, changed state to up
00:00:00:17: %LINEPROTO-5-UPDOWN: Line protocol on Interface FastEthernet 0/0, changed state to up
00:00:00:31: %SYS-5-COLDSTART: System coldstart.
Ruijie>
```

After the startup, you can configure the gateway.

-  The above startup information is for reference only. Gateway with different hardware configurations or software versions will display different startup information.
-  In case of using the gateway for the first time, you are advised to use a configuration function to configure the basic parameters of the gateway.

4.2 Starting the Gateway

To use the gateway, you need to properly configure the gateway as required. Refer to the relevant configuration guide and command reference for details about gateway configuration.

5 Troubleshooting

5.1 Power Supply Troubleshooting

Ruijie RG-EG3230 gateways provide a PWR LED on the front panel for indicating whether the power system works normally. Refer to “Product Overview” for the normal state descriptions of LED indicators. If abnormality occurs, perform the following checks:

- Whether the power switch is turned on;
- Whether the power supply of the gateway is turned on;
- Whether the power cable is properly connected;
- Whether the power supply to the gateway meets relevant requirements.



Do not plug or pull the power cable when the power switch is already turned on. If everything is ok but the PWR LED still does not light up, contact with a local dealer or technical support personnel.

5.2 Configuration System Troubleshooting

After the gateway is powered on, the terminal will display the messages described in “Starting and Configuring the Gateway” section during the startup process if the system works normally. If the configuration system fails, the terminal may display nothing or illegible characters.

If the terminal displays nothing, perform the following checks:

- Whether the power system works normally;
- Whether the console port cable is properly connected.

If everything is OK and the terminal still displays nothing, the configuration cable may be damaged or the terminal parameters may be improperly configured. Adjust the parameters of the terminal.

If the terminal displays illegible characters, the terminal parameters may be improperly configured. Confirm the following terminal parameters: baud rate being 9600; data bits being 8; parity check being none; stop bit being 1; flow control being none; terminal emulation being VT100.



If the parameters of the gateway console have been modified, the terminal will also display nothing.

Appendix A Connectors and Connection Media

1000BASE-T/100BASE-TX/10BASE-T Ports

The 1000BASE-T/100BASE-TX/10BASE-T is a port that supports adaptation of three rates, and automatic MDI/MDIX Crossover at these three rates.

The 1000BASE-T complies with IEEE 802.3ab, and uses the cable of 100-ohm Category-5 or Supper Category-5 UTP or STP, which can be up to 100 m.

The 1000BASE-T port uses four pairs of wires for transmission, all of which must be connected. Figure A-1 shows the connections of the twisted pairs used by the 1000BASE-T port.

Figure A-1 Schematic Diagram for the Four Twisted Pairs of the 1000BASE-T

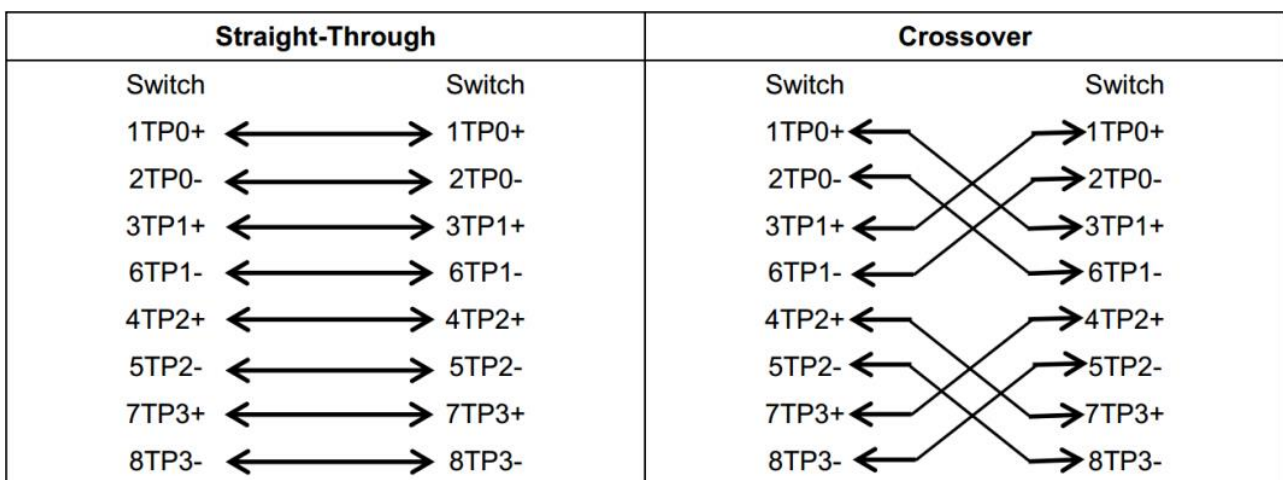

In addition to the above cables, the 100BASE-TX/10BASE-T can also use 100-ohm Category-3, 4, 5 cables for 10 Mbps, and 100-ohm Category-5 cables for 100 Mbps, both of which can be up to 100 m. 0 shows the pinouts of the 100BASE-TX/10BASE-T.

Figure A-2 Pinouts of the 100BASE-TX/10BASE-T

Pin	Socket	Plug
1	Input Receive Data+	Output Transmit Data+
2	Input Receive Data-	Output Transmit Data-
3	Output Transmit Data+	Input Receive Data+
6	Output Transmit Data-	Input Receive Data-
4,5,7,8	Not used	Not used

Figure A-3 shows the straight-through and crossover cable connections for the 100BASE-TX/10BASE-T.

Figure A-3 Connections of the Twisted Pairs of the 100BASE-TX/10BASE-T

Straight-Through		Crossover	
Switch	Adapter	Switch	Switch
1 IRD+	1 OTD+	1 IRD+	1 IRD+
2 IRD-	2 OTD-	2 IRD-	2 IRD-
3 OTD+	3 IRD+	3 OTD+	3 OTD+
6 OTD-	6 IRD-	6 OTD-	6 OTD-

Optical Fiber Connection

For the optical fiber ports, select single-mode or multiple-mode optical fibers for connection according to the fiber module connected. The connection schematic diagram is shown in Figure A-4:

Figure A-4 Schematic Diagram for optical fiber connection

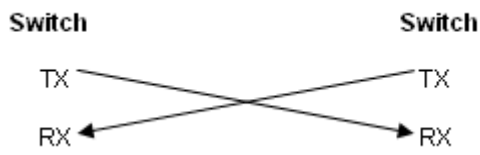

Appendix B Mini-GBIC and SFP+ Module

SFP module (Mini-GBIC module) and 10G SFP+ module are available to address the requirements of interface types of switch modules. You can select the Mini-GBIC or SFP+ module to suit your specific needs. Besides the following modules, the 10G SFP+ module also supports the Mini-GBIC-GT module. The models and technical specifications of some Mini-GBIC and 10G SFP+ modules are listed below for your reference.

Table B-1 Models and Technical Specifications of the 1000M Mini-GBIC Module

Model	Wave Length (nm)	Media Type	DDM (Yes/No)	Intensity of Transmitted Light (dBm)		Intensity of Received Light (dBm)	
				Min	Max	Min	Max
MINI-GBIC-SX-MM850	850	MMF	No	-9.5	-3	-17	0
MINI-GBIC-LX-SM1310	1310	SMF	No	-9.5	-3	-20	-3
GE-eSFP-SX-MM850	850	MMF	Yes	-9.5	-3	-17	0
GE-eSFP-LX-SM1310	1310	SMF	Yes	-9.5	-3	-20	-3
MINI-GBIC-LH40-SM1310	1310	SMF	Yes	-2	3	-22	-3
GE-SFP-SX-SM1310-BIDI	1310	MMF	No	-10	-5	-17	-3
GE-SFP-SX-SM1550-BIDI	1550	MMF	No	-10	-5	-17	-3
GE-SFP-LX20-SM1310-BIDI	1310TX/1550RX	SMF	Yes	-9	-3	-20	-3
GE-SFP-LX20-SM1550-BIDI	1550TX/1310RX	SMF	Yes	-9	-3	-20	-3
GE-SFP-LH40-SM1310-BIDI	1310TX/1550RX	SMF	Yes	-5	0	-24	-1
GE-SFP-LH40-SM1550-BIDI	1550TX/1310RX	SMF	Yes	-5	0	-24	-1
MINI-GBIC-ZX80-SM1550	1550	SMF	Yes	0	4.7	-22	-3
MINI-GBIC-ZX100-SM1550	1550	SMF	Yes	0	5	-30	-9
GE-SFP-SX	850	MMF	No	-9.5	-3	-17	0

SFP-MM850	850	MMF	No	-9.5	-3	-17	0
SFP-SM1310	1310	SMF	No	-9.5	-3	-20	-3

Table B-2 Cabling Specifications of SFP Modules

Model	Optical Fiber Type	Media Type	Core Size (μm)	Maximum Cabling Distance
MINI-GBIC-SX-MM850	LC	MMF	62.5/125	275m
			50/125	550m
MINI-GBIC-LX-SM1310	LC	SMF	9/125	10km
GE-eSFP-SX-MM850	LC	MMF	62.5/125	275m
			50/125	550m
GE-eSFP-LX-SM1310	LC	SMF	9/125	10km
MINI-GBIC-LH40-SM1310	LC	SMF	9/125	40km
GE-SFP-SX-SM1310-BIDI	LC	MMF	50/125	500m
GE-SFP-SX-SM1550-BIDI	LC	MMF	50/125	500m
GE-SFP-LX20-SM1310-BIDI	LC	SMF	9/125	20km
GE-SFP-LX20-SM1550-BIDI	LC	SMF	9/125	20km
GE-SFP-LH40-SM1310-BIDI	LC	SMF	9/125	40km
GE-SFP-LH40-SM1550-BIDI	LC	SMF	9/125	40km
MINI-GBIC-ZX80-SM1550	LC	SMF	9/125	80km
MINI-GBIC-ZX100-SM1550	LC	SMF	9/125	100km
GE-SFP-SX	LC	MMF	62.5/125	275m
			50/125	550m



-  For the optical module with transmission distance exceeding 40 km and more, one on-line optical attenuator should be added on the link to avoid the overload of the optical receiver when short single-mode optical fibers are used.
-  The optical module is a laser device. Please take care of your eyes and do not look into the laser beam directly.
-  To keep the optical module clean, please make sure that the dust cap is mounted when it is not connected to cables.

Table B-3 Specifications of SFP BIDI Optical Module Pairs

Rate/Distance	Module Pairs
1000M/500m	GE-SFP-SX-SM1310-BIDI GE-SFP-SX-SM1550-BIDI
1000M/20km	GE-SFP-LX20-SM1310-BIDI GE-SFP-LX20-SM1550-BIDI
1000M /40km	GE-SFP-LH40-SM1310-BIDI GE-SFP-LH40-SM1550-BIDI
10G /300m	XG-SFP-SR-SM1270-BIDI XG-SFP-SR-SM1330-BIDI

10G/10km	XG-SFP-LR-SM1270-BIDI XG-SFP-LR-SM1330-BIDI
----------	--

 The BIDI modules must be used in pairs (e.g., GE-SFP-LX20-SM1310-BIDI and GE-SFP-LX20-SM1550-BIDI).

Table B-4 Models and Technical Specifications of the 10G SFP+ Module

Model	Wavelength (nm)	DDM (Yes/No)	Optical Fiber Type	Intensity of Transmitted Light (dBm)		Intensity of Received Light (dBm)	
				Min	Max	Min	Max
XG-SFP-SR-MM850	850	Yes	MMF	-7.3	-1	-9.9	-1
XG-SR-MM850	850	Yes	MMF	-7.3	-1	-9.9	-1
SFP+MM850	850	Yes	MMF	-7.3	-1	-9.9	-1
XG-SFP-SR-SM1270-BI DI	1270	No	MMF	-3	4	-9	0.5
XG-SFP-SR-SM1330-BI DI	1270	No	MMF	-3	4	-9	0.5
XG-SFP-LR-SM1270-BID I	1270	No	SMF	-6.5	0.5	-14.4	0.5
XG-SFP-LR-SM1330-BID I	1330	No	SMF	-6.5	0.5	-14.4	0.5
XG-LR-SM1310	1310	Yes	SMF	-8.2	0.5	-14.4	0.5
XG-SFP-LR-SM1310	1310	Yes	SMF	-8.2	0.5	-14.4	0.5
XG-SFP-ER-SM1550	1550	Yes	SMF	-4.7	4	-11.3	-1
XG-SFP-ZR-SM1550	1550	Yes	SMF	0	4	-24	-7

Table B-5 Models and Technical Specifications of the 10G SFP+ Cables

Model	Module Type	Connector Type	Copper Cable Length(m)	Conductor Wire Diameter (AWG)	Data Rate(Gb/s)	DDM (Yes/No)
XG-SFP-AOC1M	Active	SFP+	1	N/A	10.3125	Yes
XG-SFP-AOC3M	Active	SFP+	3	N/A	10.3125	Yes
XG-SFP-AOC5M	Active	SFP+	5	N/A	10.3125	Yes
XG-SFP-AOC10M	Active	SFP+	10	N/A	10.3125	Yes

 For supported SFP+ models may change at any time, contact Ruijie Networks after-sales personnel for the latest information.

 If the DDM function of the AOC cable does not report transmit power, the TX power is allowed to be displayed as N/A.

Table B-6 Cabling Specifications of SFP+ Modules

Model	Optical Fiber Type	Media Type	Core Size (um)	Modular Bandwidth (MHz·km)	Maximum Cabling Distance
XG-SFP-SR-MM850	LC	MMF	50/125	2000(OM3)	300m
XG-SR-MM850	LC	MMF	50/125	2000(OM3)	300m
SFP+MM850	LC	MMF	50/125	2000(OM3)	300m
XG-SFP-SR-SM1270-BIDI	LC	MMF	50/125	2000(OM3)	300m
XG-SFP-SR-SM1330-BIDI	LC	MMF	50/125	2000(OM3)	300m
XG-SFP-LR-SM1270-BIDI	LC	SMF	9/125	N/A	10km
XG-SFP-LR-SM1330-BIDI	LC	SMF	9/125	N/A	10km
XG-SFP-LR-SM1310	LC	SMF	9/125	N/A	10km
XG-SFP-ER-SM1550	LC	SMF	9/125	N/A	40km
XG-SFP-ZR-SM1550	LC	SMF	9/125	N/A	80km