



Ruijie RG-WLAN Series Access Points

RGOS Configuration Guide, Release 11.9(2)B2

Copyright Statement

Ruijie Networks©2019

Ruijie Networks reserves all copyrights of this document. Any reproduction, excerpt, backup, modification, transmission, translation or commercial use of this document or any portion of this document, in any form or by any means, without the prior written consent of Ruijie Networks is prohibited.

Exemption Statement

This document is provided "as is". The contents of this document are subject to change without any notice. Please obtain the latest information through the Ruijie Networks website. Ruijie Networks endeavors to ensure content accuracy and will not shoulder any responsibility for losses and damages caused due to content omissions, inaccuracies or errors.

Preface

Thank you for using our products. This manual matches the RGOS Release 11.9(2)B2.

Audience

This manual is intended for:

- Network engineers
- Technical support and servicing engineers
- Network administrators

Obtaining Technical Assistance

- Ruijie Networks Website: <https://www.ruijienetworks.com/>
- Technical Support Website: <https://ruijienetworks.com/support>
- Case Portal: <https://caseportal.ruijienetworks.com>
- Community: <https://community.ruijienetworks.com>
- Technical Support Email: service_rj@ruijienetworks.com
- Skype: [service_rj@ruijienetworks.com](https://www.ruijienetworks.com)

Related Documents

| Documents | Description |
|---|--|
| Command Reference | Describes the related configuration commands, including command modes, parameter descriptions, usage guides, and related examples. |
| Hardware Installation and Reference Guide | Describes the functional and physical features and provides the device installation steps, hardware troubleshooting, module technical specifications, and specifications and usage guidelines for cables and connectors. |

Conventions

This manual uses the following conventions:

| Convention | Description |
|----------------------|--|
| boldface font | Commands, command options, and keywords are in boldface . |
| <i>italic font</i> | Arguments for which you supply values are in <i>italics</i> . |
| [] | Elements in square brackets are optional. |

| | |
|---------------|---|
| { x y z } | Alternative keywords are grouped in braces and separated by vertical bars. |
| [x y z] | Optional alternative keywords are grouped in brackets and separated by vertical bars. |

Symbols



Means reader take note. Notes contain helpful suggestions or references.



Means reader be careful. In this situation, you might do something that could result in equipment damage or loss of data.



WLAN Basic Configuration

1. Configuring APMG
2. Configuring CAPWAP
3. Configuring STA Management
4. Configuring WBS
5. Configuring DATA-PLANE
6. Configuring WLOG

1 Configuring APMG

1.1 Overview

N/A

1.2 Application

N/A

1.3 Features

Basic Concepts

AP

AP is an access point used by wireless terminals to access a wired network. It is equivalent to a bridge for communication between wireless terminals and a wired network.

1.4 Configuration

| Configuration | Description and Command |
|--|---|
| Configuring the Fit or Fat AP Mode |  (Optional) The AP mode can be switched between the fit AP mode and the fat AP mode according to requirements. |
| | switch2fat Switches the mode of a specified AP to the fat AP mode in AC configuration mode on the AP device. |
| | ap-mode Configures the fit or fat AP mode in global configuration mode on the AP device. |

1.4.1 Configuring the Fit or Fat AP Mode

Configuration Effect

- On the AC device, run the **switch2fat** command in AC configuration mode to switch the mode of an online AP to the fat AP mode.
- On the AP device, run the **ap-mode** command in global configuration mode to switch between the fit AP mode and the fat AP mode.

Notes

N/AN/A

Configuration Steps

- On the AP device, run the **ap-mode** command in global configuration mode to switch between the fit AP mode and the fat AP mode.

| | |
|------------------------------|---|
| Command | ap-mode { fit fat [dhcp] } macc } |
| Parameter Description | <p>fit: indicates that the AP is switched to the fit AP mode.</p> <p>fat: indicates that the AP is switched to the fat AP mode.</p> <p>dhcp: If the ap-mode fat command contains this parameter, the AP obtains the IP address through DHCP by default after the AP is switched to the fat AP mode; otherwise, the AP uses the static IP address by default after the AP is switched to the fat AP mode.</p> <p>macc: Indicates that the AP is switched to the MACC mode.</p> |
| Defaults | None |
| Command Mode | AP global configuration mode |
| Usage Guide | <p>After the AP mode is switched between the fit and fat AP modes, the AP must be restarted to ensure the configuration consistency.</p> <p>i For WALL-APs supplied by Ruijie Networks, when the fat AP mode is used, the default IP address of the rear wired network interface (connected to the PoE switching device) is 192.168.110.1/255.255.255.0, and the default IP address of the front wired network interface (Ethernet interface) is 192.168.111.1/255.255.255.0.</p> <p>i If ap-mode fat dhcp is configured, when the AP mode is switched to the fat AP mode, the IP address is obtained through DHCP by default. After the AP is restarted, if related configuration is not available, the IP address is still obtained through DHCP by default. In addition, the following two issues should also be noted:</p> <p>1.If ap-mode fat dhcp is configured for the WALL-AP, only the IP address of the rear wired network interface is obtained through DHCP, and the front wired network interface uses the static IP address by default. 2.In fat AP mode, the ap-mode fat dhcp and ap-mode fat commands cannot be mutually switched, and must be switched to the fit AP mode first.</p> |

Verification

- On the AP, run the **show ap-mode** command to check the current mode of the AP.

Configuration Example

Switching the mode of the AP to the fit AP mode on the AP

| | |
|----------------------------|---|
| Configuration Steps | <ul style="list-style-type: none"> ● Enter the global configuration mode. ● Run the ap-mode command. |
| AP | <pre>Ruijie(config)#ap-mode fit</pre> |
| Verification | On the AP, run the show ap-mode command to check the current mode of the AP. |
| AP | <pre>Ruijie#show ap-mode current mode: fit</pre> |

Common Errors

- None

1.5 Monitoring

Displaying

| Description | Command |
|--|---------------------|
| Displays the fit or fat mode of the AP | show ap-mode |

2 Configuring CAPWAP

2.1 Overview

Control And Provisioning of Wireless Access Points (CAPWAP) is a protocol proposed to address the issue of large-scale access point (AP) deployment on the wireless local area network (WLAN).

On a fit AP network, the access controller (AC) manages all APs in a unified manner through CAPWAP. The AC pushes control policies to specified APs, instead of configuring APs one by one. CAPWAP is used to set up the control channel and the data channel between an AP and an AC. The control channel is used by ACs to configure APs, or by APs to send event notifications to ACs. The data channel is used to exchange data packets between APs and ACs.

Protocols and Standards

- RFC5415: Control And Provisioning of Wireless Access Points (CAPWAP) Protocol Specification
- RFC5416: Control and Provisioning of Wireless Access Points (CAPWAP) Protocol Binding for IEEE 802.11
- RFC5417: Control And Provisioning of Wireless Access Points (CAPWAP) Access Controller DHCP Option

2.2 Applications

| Application | Description |
|--|--|
| Dynamically Setting up a CAPWAP Tunnel | An AP accesses an AC through switches. The DHCP server is deployed on the switch connected to APs. The AP obtains the AC address dynamically through DHCP to set up a CAPWAP tunnel with the AC. |
| Statically Setting up a CAPWAP Tunnel | An AP accesses an AC through switches. The static IP address of the AC is configured on the AP. The AP sets up a CAPWAP tunnel with the AC based on the configured static IP address of the AC. |
| Upgrading APs | After a CAPWAP tunnel is set up between an AC and each AP, the AC upgrades APs in a large scale through CAPWAP. |

2.2.1 Dynamically Setting up a CAPWAP Tunnel

Scenario

APs access the AC through switches. The DHCP server is deployed on the switch connected to APs. On the DHCP server, the DHCP address pool is configured and Option138 is pushed, where Option138 is the IP address of the AC. The AP obtains the AC address and sets up a CAPWAP tunnel with the AC. As shown in Figure 2-1, the AC, switches (SwitchA and SwitchB), and APs (AP1 and AP2) are connected with each other through the trunk ports. PC1 is connected to AP1, and PC2 is connected to AP2.

Figure 2-1

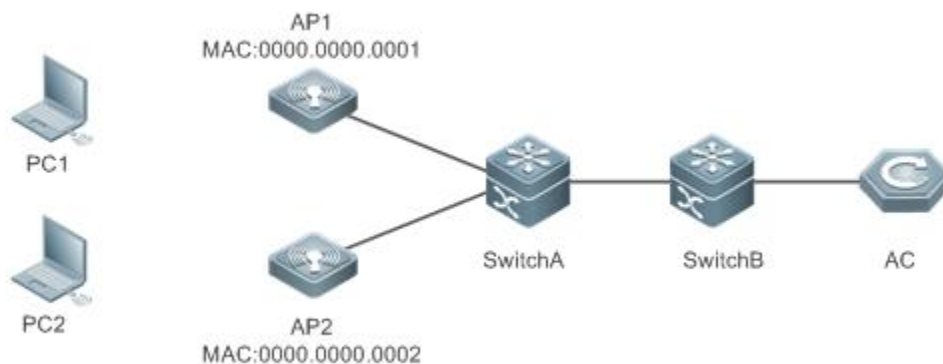

Deployment

- APs do not need to be configured one by one on a fit AP network. When an AP is powered on, the IP address must be obtained first. Therefore, a DHCP server must be deployed on the network. If the DHCP server is not deployed, the DHCP function of the AC is used to implement functions of the DHCP server.
- The AC communicates with the AP through the Layer3 (L3) switch, and the DHCP server must send Option138, which contains the IP address of the AC. After obtaining the IP address of the AC, the AP sets up a CAPWAP communication tunnel with the AC.
- On the AC, configure a loopback interface address, or run the **capwap ctrl-ip ip-address** command to configure the source address for setting up a CAPWAP tunnel.
- Configure a route to implement interworking between the AC and the IP address obtained by the AP.

2.2.2 Statically Setting up a CAPWAP Tunnel

Scenario

The AP sets up a CAPWAP tunnels with the AC based on the configured static IP address of the AC. An AP accesses an AC through switches. The topology is the same as that shown in Figure 2-1.

Deployment

- Configure the static IP addresses of ACs. The AP will send the Discover Request messages to these static IP addresses to check the effectiveness of ACs, and then select and join an AC.
- On the AC, configure a loopback interface address as the source address for setting up a CAPWAP tunnel.
- Configure a route to implement interworking between the AC and the IP address obtained by the AP.

2.2.3 Upgrading APs

Scenario

The AP obtains the AC address based on the configured static IP address of the AC or from the DHCP server, and sets up a CAPWAP tunnel with the AC. The AP accesses the AC through switches. The topology is the same as that shown in Figure 2-1.

Deployment

- On the AC, configure an IP interface address as the source address for setting up a CAPWAP tunnel.
- Configure a route to implement interworking between the AC and the IP address obtained by the AP.
- On the AC, activate the AP software that is stored locally.

2.3 Features

Basic Concepts

↘ STA, AP, and AC

STA: It is a wireless workstation that is equipped with the wireless network interface card (NIC), such as a laptop computer or a mobile phone.

AP: It is a wireless access point that provides radio signals so that the STA can access the wireless network.

AC: It is a wireless access controller that provides wireless connection and related service functions.

↘ Control channel and data channel

Control channel: It is used by ACs to configure APs, or by APs to send event notifications to ACs.

Data channel: It is used to exchange data packets between APs and ACs.

↘ AC discovery

AC discovery phase: An AP can send a discover request message by means of broadcast, multicast, DHCP, DNS, or static configuration to detect ACs, select an optimum AC from one or more ACs, join the AC, and set up a CAPWAP session with the AC.

↘ Datagram Transport Layer Security (DTLS)

The CAPWAP control channel uses the DTLS protocol for key negotiation and encryption.

↘ Option

The Option information sent by the DHCP server can carry the IPv4 or IPv6 address of an AC. The AP obtains the AC address from the Option information sent by the DHCP server.

The AP can obtain the IP address of an AC using Option 138 or Option 43, or obtain the IPv6 address of an AC using Option 52. When configuring the DHCP server of the AP, you must configure the related options to set the IP address of the AC; otherwise, the AP cannot discover the AC through DHCP discovery.

Option 138 and Option 52 are standard formats defined in RFC5417, and Option 43 is defined by vendors. Currently, Option 43 in the following formats can be analyzed:

Format 1: Assume that the IP address of a specified AC is 1.1.1.1. The corresponding configuration is Option 43 hex f10401010101.

```

0 1 2 3 4 5 6 7 8 9 0 1 2 3 4 5 6 7 8 9 0 1 2 3 4 5 6 7 8 9 0 1
+-----+
| option-code | option-length | Sub-opt Type | Sub-opt Len |
+-----+
|      Server Address      |
+-----+
    
```

option-code: indicates the option code. In this example, the option code is 43 in decimal format.

option-length: indicates the length of the option data, which excludes option-code and option-length.

Sub-opt Type: indicates the sub-option type. In this example, the sub-option type is 0xF1, that is, 241 in decimal format.

Sub-opt Len: indicates the length of the sub-option, which is equal to (Number of addresses x 4).

Server Address: indicates the server address.

Format 2: Assume that the IP address of a specified AC is 1.1.1.1. The corresponding configuration is option 43 hex 800700000101010101.

```

0 1 2 3 4 5 6 7 8 9 0 1 2 3 4 5 6 7 8 9 0 1 2 3 4 5 6 7 8 9 0 1
+-----+
| option-code | option-length | Sub-opt Type | Sub-opt Len |
+-----+
|      PXE Server Type      | PXE Server Num|
+-----+
|      PXE Server Address      |      ...      |
+-----+
    
```

option-code: indicates the option code. In this example, the option code is 43 in decimal format.

option-length: indicates the length of the option data, which excludes option-code and option-length.

Sub-opt Type: indicates the sub-option type. In this example, the sub-option type is 0x80, that is, 128 in decimal format.

Sub-opt Len: indicates the length of the sub-option, which is equal to (Number of addresses x 4 +3).

Server Type: indicates the server type. The value is 0x0000.

Server Num: indicates the number of server addresses.

Server Address: indicates the server address.

Format 3: Assume that the IP address of a specified AC is 1.1.1.1. The corresponding configuration is option 43 hex 01010101.

```

0 1 2 3 4 5 6 7 8 9 0 1 2 3 4 5 6 7 8 9 0 1 2 3 4 5 6 7 8 9 0 1
+++++
| option-code | option-length | Server Address |
+++++
| Server Address | ... |
+++++
    
```

option-code: indicates the option code. In this example, the option code is 43 in decimal format.

option-length: indicates the length of the option data, which excludes option-code and option-length.

Server Address: indicates the server address.

Overview

| Feature | Description |
|---|--|
| Discovering an AC by an AP | The AP discovers potential ACs. |
| Joining an AC by an AP | The AP selects an optimum AC from one or more ACs, joins the AC, and sets up a CAPWAP tunnel with the AC. |
| Upgrading APs | After a CAPWAP tunnel is set up between an AC and each AP, the AC upgrades APs in a large scale. |
| Forwarding Data on the Tunnel | After a CAPWAP tunnel is set up between an AC and each AP, data packets can be exchanged through the data channel. |

2.3.1 Discovering an AC by an AP

An AP discovers potential ACs by sending a Discovery Request message.

Working Principle

As soon as an AP is connected to the network, the AP enters the process of discovering ACs. The AP sends a Discovery Request message by means of broadcast, multicast, or unicast. If unicast is used, the AP obtains the AC IP address list through the DHCP server, DNS, or configuration of the static AC IP addresses.

2.3.2 Joining an AC by an AP

The AP selects an optimum AC from one or more ACs, joins the AC, and sets up a CAPWAP tunnel with the AC.

Working Principle

The AP sends a Discovery Request message to ACs. ACs that receive the Discovery Request message return a Discovery Response message to the AP. Among the ACs that send the response message, the AP selects an optimum AC, and sets up

a DTLS connection with this AC. After the DTLS connection is successfully set up, the AP sends a Join Request message. The AC returns a Join Response message to confirm that the AP is added to the management scope of the AC, and starts to provide services for this AP.

2.3.3 Upgrading APs

After a CAPWAP tunnel is set up between an AC and each AP, the AC upgrades APs in a large scale.

Working Principle

After an AP joins an AC, if the AP firmware version expires, the AP enters the firmware upgrade process. The AP downloads the latest firmware version from the AC, restarts after the successful upgrade, and reinitiates an AC discovery process. If the AP firmware is of the latest version, the AP downloads configuration parameters from the AC and starts running. Figure 2-2 shows the working principle.

Figure 2-2

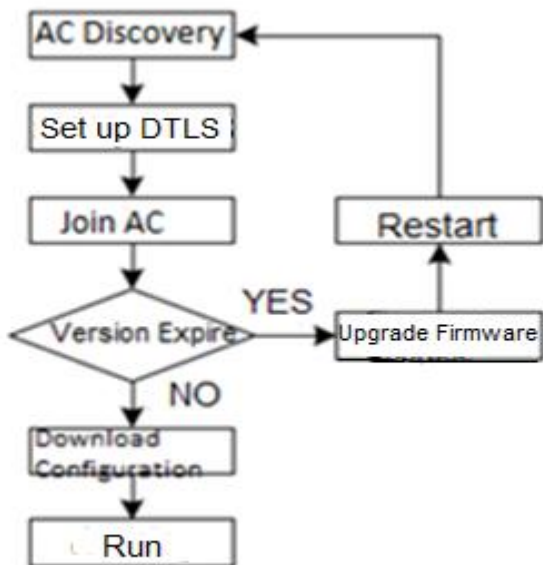
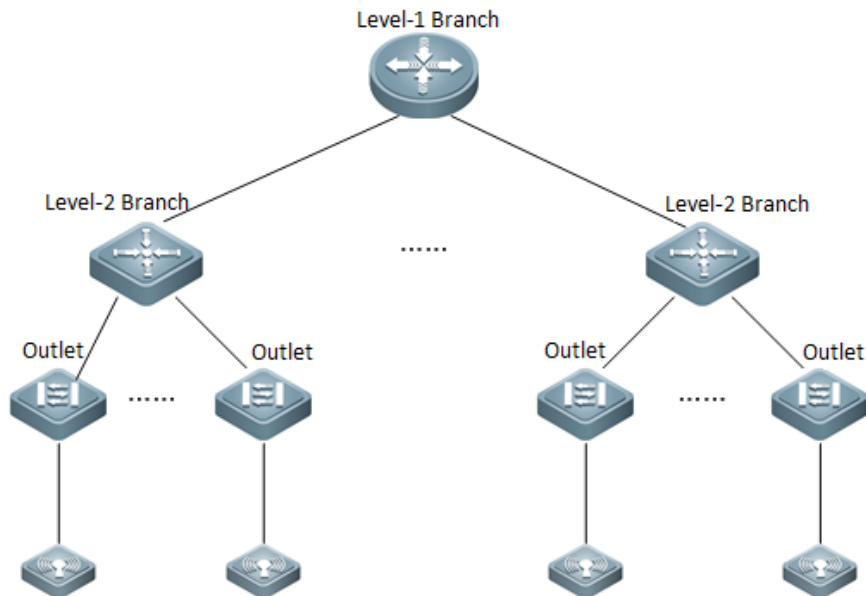

Figure 2-3 shows the typical upgrade scenario where the bandwidth is limited.

Figure 2-3



The following explains the configuration method for upgrading APs in a bank. Assume that the bank consists of one level-1 branch and multiple level-2 branches, and each branch has hundreds of outlets. One AP is deployed in one outlet, and the AC is deployed in the level-1 branch. The bandwidth between the level-1 bank and the level-2 bank is 20 Mbps, and the bandwidth between the level-2 bank and the outlet is 2 Mbps. To prevent affecting normal service provisioning of the bank, the bandwidth occupied by the AP upgrade process cannot exceed 50% of the total available bandwidth. Assume that there are eight level-2 branches, eight upgrade groups are configured on the AC, and APs of outlets under each level-2 branches are added to the corresponding upgrade group. For each AP, the maximum available bandwidth is 1 Mbps. Therefore, a bandwidth of 128 Kbps (1MByte = 128KByte) should be configured for each AP. Under each level-2 branch, the number of APs that can be upgraded concurrently is 10 (10 Mbps/1 Mbps). In addition, it is recommended that the maximum number of APs that can be concurrently upgraded by an AC be set to the number of upgrade groups multiplied by the number of APs that can be upgraded concurrently in a upgrade group, that is, 80.

2.3.4 Forwarding Data on the Tunnel





After a CAPWAP tunnel is set up between an AC and each AP, data packets can be exchanged over the data channel.





Working Principle

The CAPWAP sets up a control channel and a data channel between APs and ACs. The control channel is used by ACs to configure APs, or by APs to send event notifications to ACs, and must be encrypted. The data channel is used to exchange the 802.11 or 802.3 frames between APs and ACs. When running on the IPv4 protocol stack, the CAPWAP uses the UDP for data transmission. When running on the IPv6 protocol stack, the CAPWAP uses the UDP over the control channel, and UDP or UDP-lite over the data channel for data transmission.

2.4 Configuration

| Configuration | Description and Command | |
|--|--|---|
| Configuring the AC Location | ⚠ (Optional) It is used to configure the location information of an AC. | |
| | location | Configures the location information of an AC so that the physical location of the AC can be viewed. |
| Configuring the version number | ⚠ (Optional) It is used to configure the version number. | |
| | set-version | Configures the version number, |
| Configuring the AP Location | ⚠ (Optional) It is used to configure the location information of an AP. | |
| | location | Configures the location information of an AP so that the physical location of the AP can be viewed. |
| Configuring AP Time Synchronization | ⚠ (Optional) It is used to enable the AP to synchronize the time with the AC. | |
| | timestamp | Enables the AP to synchronize the time with the AC. |
| Configuring the Default VLAN of an AP | ⚠ (Optional) It is used to configure the native VLAN of an AP. | |
| | ap-vlan | Configures the default VLAN of an AP. |
| Configuring the Transmission VLAN | ⚠ (Optional) It is used to configure the transmission VLAN of an AP. | |
| | pass-vlan | Configures the transmission VLAN of an AP. |
| Configuring the VLAN of AP Wired Users | ⚠ (Optional) It is used to configure the VLAN of wired users when the AP provides an Ethernet interface for access of wired users. | |
| | wired-vlan | Configures the VLAN used by the wired network port. |
| Configuring the Wired Network Port Status of an AP | ⚠ (Optional) It is used to disable wired network ports when the AP provides Ethernet ports for access of wired users. | |
| | wired-interface | Disables wired network ports of an AP. |
| Configuring the Sub-Interface of the WAN Interface on the AP | ⚠ (Optional) It is used to configure the sub-interface of the WAN interface on the AP. | |
| | ap-subif | Configures the sub-interface of the WAN interface on the AP. |
| Configuring Data to Allow an AP to Join an AC | ⚠ (Optional) It is used to configure an AP on the AC to set up a CAPWAP tunnel. | |
| | ac-control disable | Configures the AC. |
| | ac-domain-name | Configures the DNS domain name of the AP, which is used to obtain the AC address. |

| | | |
|---|--|---|
| | acip ipv4 | Configures the static IP address of the AC accessed by the AP. |
| | acip ipv6 | Configures the static IPv6 address of the AC accessed by the AP. |
| | ip address | Configures the static IP address, subnet mask, and gateway. |
| | ipv6 address | Configures the static IPv6 address and gateway. |
| | ipv6 enable | Enables the CAPWAP IPv6 function on the AP. |
| Configuring the ERPS ring |  (Optional) It is used to configure the ERPS ring. | |
| | ap-cfg erps raps-vlan | Configures the EPRS ring. |
| Configuring an AP via an AC |  (Optional) It is used to configure an AP via an AC. | |
| | exec-cmd | Executes ap-config commands on an AP/AP group via an AC. |
| Configuring a Fit AP |  (Optional) It is used to perform pre-configuration on an AP to set up a CAPWAP tunnel. | |
| | acip ipv4 | Configures the static IP address of the AC accessed by the AP. |
| | acip ipv6 | Configures the static IPv6 address of the AC accessed by the AP. |
| | apip | Configures the static IP address, subnet mask, and gateway. |
| | apip ipv6 address | Configures the static IPv6 address and gateway. |
| | apip ipv6 address autoconfig default | Enables the AP to use the IPv6 stateless address auto configuration and generates a default route. |
| | apip ipv6 enable | Enables the IPv6 function of the AP. |
| | apip pppoe | Enables the AP to use the PPPoE dial-up mode to obtain the address. |
| Configuring AP Upgrade |  (Optional) It is used to configure the AP upgrade data. | |
| | ap-serial | Creates the name of an AP product series, and specifies the AP product models that belong to this series. |
| | ap-image | In AP configuration mode, configures the specified AP upgrade version. In AC configuration mode, configures the specified AP software version that should be used by a specified AP product series for the upgrade, or sets the adaptive upgrade mode. |
| | active-bin-file | Activates the AP software version file. |

| | | |
|---|--|---|
| | capwapupgrade max-concurrent | Configures the maximum number of APs that can be concurrently upgraded by the AC. |
| | capwap upgrade group | In AC configuration mode, creates a bandwidth control upgrade group. |
| | ap-upgrade band-width | In AC configuration mode, configures the bandwidth for centralized AP upgrade. |
| | ap-upgrade group | In AC configuration mode, adds APs to the bandwidth control upgrade group. |
| Configuring the CAPWAP Control Address |  (Optional) It is used to configure the control IP address of the CAPWAP tunnel. When this address is not configured, the address of the loopback interface is used as the control IP address by default. | |
| | capwap ctrl-ip | Configures the control IP address of the CAPWAP tunnel. |
| Configuring CAPWAP Fragmentation |  (Optional) It is used to configure CAPWAP fragmentation. | |
| | capwap mtu | Configures the maximum transmission unit (MTU) on the tunnel of a specified AP. |
| | capwap fragment enable | Enables CAPWAP fragmentation for a specified AP. |
| Configuring CAPWAP Encryption |  (Optional) It is used to configure CAPWAP encryption. | |
| | capwap data-tunnel encryption | Enables data channel encryption of a specified AP. |
| | capwap dtls enable | Enables encryption on the CAPWAP control channel. |
| Configuring CAPWAP Access Control |  (Optional) It is used to control the maximum number of APs that can concurrently go online. | |
| | capwap max-concurrent | Configures the maximum number of APs that can concurrently go online. |
| Configuring the Echo Interval of the CAPWAP Tunnel |  (Optional) It is used to configure the echo interval of the CAPWAP tunnel. | |
| | echo-interval | Configures the echo interval of the CAPWAP tunnel. |
| Configuring the Maximum Retransmission Times of a CAPWAP Packet | (Optional) It is used to configure the maximum transmission times of a CAPWAP packet. | |
| | capwap max-retransmit | Configures the maximum transmission times of a CAPWAP packet. |

2.4.1 Configuring the AC Location

Configuration Effect

- Configure the location information of an AC so that users can conveniently check the locations of ACs on the WLAN.

Notes

- The location information is a string of 1 to 255 characters, and cannot contain any space.

Configuration Steps

- (Optional) Configure the AC location so that users can conveniently check the locations of ACs when a large number of ACs exist on the network.
- Enter the AC configuration mode, and run the **location** command to configure the AC location on the AC.
- Use the **no** form of this command to restore the default setting.

| | |
|---------------------|---|
| Command | location <i>location-string</i> |
| Parameter | <i>location-string</i> : indicates the location of an AC. The location is a string of 1 to 255 characters, and cannot contain any space. |
| Description | |
| Defaults | Ruijie_COM |
| Command Mode | AC configuration mode |
| Usage Guide | The AC location information is Ruijie_COM by default. You can configure the location information for each AC according to actual requirements so that you can conveniently check the AC location on the WLAN. |

Verification

- Run the **show ac-config** command to display the AC location information and accordingly determine whether the configuration is successful.

Configuration Example

Configuring the AC Location Information as "Computer-layer2"

| | |
|----------------------------|--|
| Configuration Steps | <ul style="list-style-type: none"> ● Enter the AC configuration mode. ● Configure the AC location information. |
| AC | <pre>Ruijie(config)#ac-controller Ruijie(config-ac)# locationcomputer-layer2</pre> |
| | <ul style="list-style-type: none"> ● Use the no form of this command to restore the default AC location information. |
| AC | <pre>Ruijie(config)#ac-controller Ruijie(config-ac)#no location</pre> |
| Verification | Run the show ac-config command to display the current location of the AC. |
| AC | <pre>Ruijie#show ac-config ac location :Ac_COM</pre> |

Common Errors

- N/A

2.4.2 Configuring the Version Number

Configuration Effect

- Customize the firmware version.

Notes

- The customized version number contains a maximum of 63 characters.

Configuration Steps

- Optional.
- Run this command to configure the customized firmware version number.
- Use the **no** form of this command to restore the default settings.

| | |
|------------------------------|--|
| Command | set-version <i>string</i> |
| Parameter Description | <i>string</i> : indicates the customized version number. |
| Defaults | N/A |
| Command Mode | AC configuration mode |
| Usage Guide | This command is used to configure the firmware version number of the AC and push the firmware version number to APs. |

Verification

- Run the **show version** command to display the version number.

Configuration Example

Configuring the Customized Firmware Version Number to RGOS 10.4(2B17)-SP2

| | |
|----------------------------|--|
| Configuration Steps | Enter the AC configuration mode. Configure the customized version number. |
| AC | <pre>Ruijie(config)#ac-controller Ruijie(config-ac)# set-version RGOS 10.4(2B17)-SP2</pre> |
| Verification | Run the show version command to display the version number. |

| | |
|-----------|---|
| AC | <pre>Ruijie#show version System software version : RGOS 10.4(2B17)-SP2</pre> |
|-----------|---|

Common Errors

N/A

2.4.3 Configuring the AP Location

Configuration Effect

- Configure the location information of an AP.

Notes

- The AP location information is a string of 1 to 255 characters, and cannot contain any space.

Configuration Steps

▾ Configuring the AP Location Information

- Optional.
- Run the **location** command to configure the AP location information.
- You can enter the AP configuration mode and configure the AP location information on the AC so that you can conveniently learn the physical location of the AP.

| | |
|------------------------------|---|
| Command | location <i>location-string</i> |
| Parameter Description | <i>location-string</i> : indicates the location of an AP. The location is a string of 1 to 255 characters, and cannot contain any space |
| Defaults | Null |
| Command Mode | AP configuration mode |
| Usage Guide | N/A |

Verification

- Run the **show ap-config running** command to display the AP location information.

Configuration Example

▾ Configuring the Location Information of AP0001 as "AP-company"

| | |
|----------------------------|---|
| Configuration Steps | <ul style="list-style-type: none"> ● Enter the AP configuration mode on the AC. ● Configure the location information of AP0001 as "AP-company". |
| AC | <pre>Ruijie(config)# ap-config AP0001 Ruijie(config-ap)# location AP-company</pre> |

| | |
|---------------------|--|
| Verification | <ul style="list-style-type: none"> Run the show ap-config running command to display the location information of AP0001. |
| AC | <pre>Ruijie#show ap-config running ! ap-config AP0001 location AP-company !</pre> |

Common Errors

- N/A

2.4.4 Configuring AP Time Synchronization

Configuration Effect

- Enable a specified AP or all APs in an AP group to synchronize the time with the AC.

Notes

- N/A

Configuration Steps

▾ Enabling a Specified AP or All APs in an AP Group to Synchronize the Time with the AC

- Optional.
- To synchronize the time on the AP with that on AC, enter the AP or AP group configuration mode on the AC and run the **timestamp** command.

| | |
|---------------------|--|
| Command | timestamp |
| Parameter | N/A |
| Description | |
| Defaults | N/A |
| Command Mode | AP configuration mode or AP group configuration mode |
| Usage Guide | N/A |

Verification

- Check whether the time on the AC is the same as that on the AP.

Configuration Example

▾ Enabling AP0001 to Synchronize the Time with the AC

| | |
|----------------------------|--|
| Configuration Steps | <ul style="list-style-type: none"> ● Enter the AP configuration mode on the AC. ● Enable AP0001 to synchronize the time with the AC. |
| AC | <pre>Ruijie(config)# ap-config AP0001 Ruijie(config-ap)# timestamp</pre> |
| Verification | <ul style="list-style-type: none"> ● Run the show clock command to display the time on the AP0001 and the AC. |
| AC | <pre>Ruijie#showclock 16:41:05 UTC Thu, Oct 17, 2013</pre> |

Common Errors

- N/A

2.4.5 Allowing an AP to Join an AC

Configuration Effect

- Configure the static IP addresses of ACs. The AP will send the Discover Request messages to these static IP addresses to check the effectiveness of ACs, and then select and joint an AC to set up a CAPWAP tunnel.

Notes

- A fit AP is generally not configured. It can discover ACs by means of broadcast, unicast, DHCP, or DNS, or join ACs based on the statically configured AC addresses.
- If the AP address is configured as the static address, the DHCP/DHCPv6 function will be disabled. In this case, the AC address cannot be obtained from the DHCP/DHCPv6 option. Therefore, before this command is configured, you need to configure the address of the connected AC in AP configuration mode so that the AP can discover and join the AC when the AP and the AC are not in the same subnet.
- If the current address of the AP is different from the address specified in the AC command, the AP static address will be updated and the CAPWAP tunnel will be re-established. If IPv6 is not enabled on the AP, the CAPWAP tunnel will not be re-established.
- If both the IPv4 and IPv6 addresses of the AP are specified in the configuration, and IPv6 is enabled on the AP, the AP will discover the IPv4 and IPv6 ACs simultaneously.

Configuration Steps

▾ Configuring the Static AC Address

- Optional.
- The AC address can be obtained through DHCP or DNS. Alternatively, the static AC address can be configured in AP configuration mode on the AC or configured on the AP.
- When the AC address is obtained in static mode, run the **acip ipv4** or **acip ipv6** command to configure the static AC address.

| | |
|------------------------------|--|
| Command | acip ipv4 <i>ip-address[ip-address...]</i> |
| Parameter Description | <i>ip-address</i> : indicates the static IP address. At most six static addresses can be configured. |
| Defaults | No static AC IP address is configured by default. |
| Command Mode | Global configuration mode on the AP or AP configuration mode on the AC |
| Usage Guide | - |

| | |
|------------------------------|--|
| Command | acip ipv6 <i>ipv6-address[ipv6-address...]</i> |
| Parameter Description | <i>ipv6-address</i> : indicates the static IP address. At most six static addresses can be configured. |
| Defaults | N/A |
| Command Mode | Global configuration mode on the AP or AP configuration mode on the AC |
| Usage Guide | N/A |

📌 Configuring the Domain Name Used by the AP to Discover the AC

- (Optional) Run the **ac-domain-name** command to configure the DNS domain name on the AC so that the AP can discover the AC based on the DNS domain name.
- When the AC address is obtained in dynamic mode, configure the DNS domain name on the AC. The AC address can be obtained based on the DNS domain name.
- Generally, if the DNS domain name is not configured, the AP cannot obtain the IP address of the AC through the DNS.

| | |
|------------------------------|--|
| Command | ac-domain-name <i>ac-domain-name</i> |
| Parameter Description | <i>ac-domain-name</i> : indicates the AC domain name. |
| Defaults | ac.ruijie.com.cn |
| Command Mode | AP configuration mode or AP group configuration mode on the AC |
| Usage Guide | N/A |

📌 Configuring the Static IP Address of the AP

- Optional.
- On the AP, configure the static IPv4 or IPv6 address of the AP so that the AP can use the fixed IPv4 or IPv6 address to access the AC.

| | |
|------------------------------|--|
| Command | ip address <i>ip-address network-mask gateway</i> |
| Parameter Description | <i>ip-address</i> : indicates the IP address of the AP. <i>network-mask</i> : indicates the subnet mask of the AP. <i>gateway</i> : indicates the gateway of the AP. |
| Defaults | N/A |

| | |
|---------------------|---|
| Command Mode | AP configuration mode |
| Usage Guide | An AP can obtain its own IP address through the static configuration or DHCP. If the static IP address is not configured on the AP, the AP obtains the address through DHCP and joins the AC. In this case, you can run this command to configure the static IP address of the AP so that the address can remain unchanged after the AP is restarted. |

▾ Configuring the Static IPv6 Address of a Specific AP

- Optional.

| | |
|------------------------------|--|
| Command | ipv6 address <i>ipv6-address-with-mask gateway</i> |
| Parameter Description | <i>ipv6-address-with-mask</i> : indicates the IPv6 address of the AP. The format is X:X:X::X/24. <i>gateway</i> : indicates the IPv6 gateway of the AP. |
| Defaults | - |
| Command Mode | AP configuration mode |
| Usage Guide | When IPv6 is enabled, the AP can obtain its own IPv6 address through the static configuration or DHCPv6. If the static IPv6 address is not configured on the AP, the AP obtains the address through DHCPv6 and joins the AC. In this case, you can run this command to configure the static IPv6 address of the AP so that the address can remain unchanged after the AP is restarted. |

▾ Enabling the AP to Support IPv6 Access

- Optional.
- Run this command to control whether an AP sets up a CAPWAP IPv6 tunnel.
- If a CAPWAP IPv6 tunnel needs to be set up, run the **ipv6 enable** command in AP configuration mode on the AC to support establishment of the IPv6 tunnel.

| | |
|------------------------------|---|
| Command | ipv6 enable |
| Parameter Description | - |
| Defaults | IPv6 is disabled on the AP by default. |
| Command Mode | AP configuration mode |
| Usage Guide | If the IPv6 enable/disable status of the AP changes due to configuration of this command, the AP re-establishes the CAPWAP tunnel. When IPv6 is enabled on the AP, and the AP is configured with both static IPv4 and IPv6 addresses, the AP attempts to discover the IPv4 and IPv6 ACs simultaneously during re-establishment of the CAPWAP tunnel. For discovered ACs, the AP does not necessarily select and join an IPv6 AC. To ensure that the AP selects and joins an IPv6 AC, delete the IPv4 static address of the AP and retain only the static IPv6 address of the AP before IPv6 is enabled on the AP. |

▾ Configuring the Fit AP to Access the AC

- Optional.

- Run this command to control whether an AP accesses an AC.
- This command is supported on S5750H and EG device.

| | |
|------------------------------|---|
| Command | no ac-control disable |
| Parameter Description | N/A |
| Defaults | The fit AP cannot access the AC by default. |
| Command Mode | AC configuration mode |
| Usage Guide | The wireless switch (S5750H) and wireless gateway (EG device) can serve only as the switch and gateway or ACs on the network. When they serve only as the switch and gateway, the fit AP is expected to access the actual AC but not S5750H or EG device. This command can be used to control the access of the AP. |

Verification

- Run the **show ap-config running** command to check whether the configuration is successful.

Configuration Example

▾ Enabling the AP to Obtain the IP Address of the AC Based on the Static IPv4 Address of the AP

| | |
|----------------------------|---|
| Configuration Steps | <ul style="list-style-type: none"> • Enter the AP configuration mode on the AC. • Set the static IP address of the AC accessed by the AP to 192.168.1.1. • Set the static IP address of the AP to 1.1.1.1, subnet mask to 255.255.255.0, and gateway to 1.1.1.2. |
| AC | <pre>Ruijie(config)# ap-config AP0001 Ruijie(config-ap)# acip ipv4 192.168.1.1 Ruijie(config-ap)# ip address 1.1.1.1 255.255.255.0 1.1.1.2</pre> |
| Verification | <ul style="list-style-type: none"> • Check the AP configurations. |
| AC | <pre>Ruijie#show ap-config running ! ap-config AP0001 acip ipv4 192.168.1.1 ip address 1.1.1.1 255.255.255.0 1.1.1.2 !</pre> |

▾ Enabling the AP to Obtain the IP Address of the AC Based on the DNS Domain Name

| | |
|----------------------------|---|
| Configuration Steps | <ul style="list-style-type: none"> • Enter the AP configuration mode on the AC. • Set the DNS domain name of the AC to ruijie-ac. |
|----------------------------|---|

| | |
|---------------------|---|
| AC | <pre>Ruijie(config)# ap-config AP0001 Ruijie(config-ap)# ac-domain-name ruijie-ac</pre> |
| Verification | <ul style="list-style-type: none"> ● Check the AP configurations. |
| AC | <pre>Ruijie#show ap-config running ! ap-config AP0001 ac-domain-name ruijie.ac !</pre> |

▾ Enabling IPv6 on the AP

| | |
|----------------------------|--|
| Configuration Steps | <ul style="list-style-type: none"> ● Enter the AP configuration mode on the AC. ● Enable IPv6 on the AP. |
| AC | <pre>Ruijie(config)# ap-config AP0001 Ruijie(config-ap)# ipv6 enable</pre> |
| Verification | <ul style="list-style-type: none"> ● Check the AP configurations. |
| AC | <pre>Ruijie#show ap-config running ! ap-config AP0001 ipv6 enable !</pre> |

▾ Configuring the Fit AP to Access the AC

| | |
|----------------------------|--|
| Configuration Steps | <ul style="list-style-type: none"> ● Enter the AC configuration mode. ● Configure the fit AP to access the AC. |
| AC | <pre>Ruijie(config)#ac-controller Ruijie(config-ac)#no ac-control disable</pre> |
| Verification | <ul style="list-style-type: none"> ● Check the AP configurations. |
| AC | <pre>Ruijie#show ap-config running ! ac-controller no ac-control disable</pre> |

Common Errors

- N/A

2.4.6 Configuring the ERPS Function on the AP

Configuration Effect

- The i-Share+ master AP requires the Ethernet Ring Protection Switching (ERPS) function. The fit AP does not save any configuration and therefore, the ERPS command needs to be saved.

Notes

- A link needs to be disconnected or a port needs to be shut down during network planning. The ring topology can be built only after the ERPS link is configured.
- Configure a Ring Protection Link (RPL) link on a device in the ERPS ring, so that traffic is balanced to dual upstream links. When one link fails or one device is faulty, the blocked RPL link is connected to prevent link failure.
- The VLAN used by the ERPS will occupy the VLAN capacity of the device. Therefore, the VLAN cannot be set to VLAN 1 or VLAN 2444, both of which are default VLANs. It cannot be the same with the VLAN of an STA specified by the **Interface-mapping** command or the VLAN of a wired port specified by the **wired-VLAN** command. It cannot be the same with the VLAN specified by the **ap-vlan** command, neither.

Configuration Steps

▾ Configuring an ERPS Single Ring

- Optional.
- Only the i-Share+ master AP supports this command.

| | |
|------------------------------|---|
| Command | ap-cfg erps raps-vlan <i>vlan-id</i> ring-port west <i>interface-name1</i> east <i>interface-name2</i> |
| Parameter Description | <i>vlan-id</i> : indicates the R-APS VLAN ID. <i>interface-name1</i> : indicates the name of the west port. <i>interface-name2</i> : indicates the name of the east port. |
| Defaults | N/A |
| Command Mode | AP configuration mode |
| Usage Guide | N/A |

| | |
|----------------|--|
| Command | ap-cfg erps raps-vlan <i>vlan-id</i> rpl-port { west east } rpl-owner |
|----------------|--|

| | |
|------------------------------|---|
| Parameter Description | <p><i>vlan-id</i>: indicates the R-APS VLAN ID.</p> <p>West: specifies the west port to be the RPL owner.</p> <p>east: specifies the east port to be the RPL owner.</p> |
| Defaults | N/A |
| Command Mode | AP configuration mode |
| Usage Guide | N/A |

Verification

- Run the **show erps** command to display the ERPS configuration.

Configuration Example

Configuring the ERPS Function on the AM5528

| | |
|----------------------------|--|
| Configuration Steps | <ul style="list-style-type: none"> ● Enter the AP configuration mode of the AC. ● Configure an ERPS single ring. ● Configure the RPL port. |
| AP | <pre>Ruijie(config)#ap-cfg erps raps-vlan 10 ring-port west gigabitEthernet 0/26 east gigabitEthernet 0/25 Ruijie(config)#ap-cfg erps raps-vlan 10 rpl-port east rpl-ower</pre> |
| Verification | <ul style="list-style-type: none"> ● Run the show erps command to display the ERPS configuration. |

| | |
|-----------|--|
| AP | <pre> Ruijie(config)#show erps ERPS Information Global Status : Enabled Link monitored by : Not Oam ----- R-APS VLAN : 10 Ring Status : Enabled West Port : Gi0/26 (Link Failure) East Port : Gi0/25 (Forwarding) RPL Port : East Port Protected VLANs : ALL RPL Owner : Enabled Holdoff Time : 0 milliseconds Guard Time : 500 milliseconds WTR Time : 2 minutes Current Ring State : protection Associate R-APS VLAN : Ruijie(config)# </pre> |
|-----------|--|

Common Errors

- N/A

2.4.7 Configuring an AP to Execute a Command

Configuration Effect

- (Optional) On the AC, configure an AP to execute a command.
- (Optional) On the AC, configure all APs in an AP group to execute a command.

Notes

- N/A

Configuration Steps

📌 Configuring an AP to Execute a Command

- (Optional) Enter the AP configuration mode.

- On the AC, configure the AP to execute a command.

| | |
|------------------------------|---|
| Command | exec-cmd mode <i>exec-mode</i> cmd <i>exec-cmd</i> once |
| Parameter Description | <i>exec-mode</i> : indicates the mode in which a command is executed on the AP. <i>exec-cmd</i> : indicates the command to be executed on the AP. once : indicates that the command is executed only once and is not saved. |
| Defaults | N/A |
| Command Mode | Single AP configuration mode/All APs configuration mode |
| Usage Guide | Some configuration commands are supported currently only by the AP and they are unavailable on the AC. To configure the commands for APs on the AC, run the exec-cmd command. To cancel or change the configuration of the exec-cmd command, run the no exec-cmd command to remove the configuration and then run the exec-cmd command to cancel or change the required configuration. If ap-config all and ap-config are configured simultaneously, for online APs, the later configuration will take effect; for offline APs, ap-config has a higher priority than ap-config all . |

Verification

- Log in to the AP to check whether the configuration takes effect. On the AC, run the **show run** or **show ap-config run** command to check whether the configuration takes effect.

↘ Configuring APs in an AP Group to Execute a Command

- (Optional) Enter the AP group configuration mode.
- Configure all APs in an AP group to execute a command.

| | |
|------------------------------|--|
| Command | exec-cmd <i>exec-cmd</i> |
| Parameter Description | <i>exec-cmd</i> : indicates the command to be executed on all APs in an AP group. |
| Defaults | N/A |
| Command Mode | AP group configuration mode. |
| Usage Guide | Some configuration commands are available only in AP configuration mode and they are unavailable in AP group configuration mode. To configure such a command for all APs in an AP group, run the exec-cmd command in the AP group. Note that the configuration is not saved in AP group configuration mode, that is, the command is executed only once on all APs in the current AP group. If the configuration already exists in AP configuration mode, the original configuration will be overridden when the command is executed in AP group configuration mode. |

Verification

- Run the **show ap-config run** command to check whether the configuration of the APs in an AP group takes effect.

Configuration Example

Disabling the Eweb Function for an AP on the AC and Configuring Bluetooth iBeacon for all APs in an AP Group

| | |
|----------------------------|--|
| Configuration Steps | <ul style="list-style-type: none"> ● On the AC, disable the Eweb function for APs. ● On the AC, enable the Eweb function for APs. ● Enable Bluetooth iBeacon for all APs in an AP group. ● Disable the Eweb function for all APs in the AP group. |
| AC | <pre>Ruijie(config)#ap-config AP1 Ruijie(config-ap)# exec-cmd mode configure cmd "no enable service web-server all" Ruijie(config-ap)# no exec-cmd mode configure cmd "no enable service web-server all" Ruijie(config-ap)# exec-cmd mode configure cmd "enable service web-server all" Ruijie(config)#ap-group default Ruijie(config-group)#exec-cmd ibeacon uuid ffffffff major ffff minor ffff Ruijie(config-group)#exec-cmd exec-cmd mode configure cmd "no enable service web-server all"</pre> |
| | |
| Verification | <ul style="list-style-type: none"> ● On the AC, check whether the configuration takes effect. |
| AC | <pre>Ruijie#show ap-config running ap-config AP1 exec-cmd mode configure cmd "no enable service web-server all" ibeacon uuid ffffffff major ffff minor ffff</pre> |

Common Errors

The **exec-cmd** command needs to be changed, but the **no exec-cmd** command is not executed to delete original configuration, or the **exec-cmd** command is not re-executed to cancel the configuration.

2.4.8 Configuring a Fit AP

Configuration Effect

- Configure the static IP address, subnet mask, next hop, and AC address on a fit AP so that the AP can use the static address to communicate with the AC.

Notes

- If the AP address is configured as the static address, the DHCP function will be disabled. In this case, the AC address cannot be obtained from the DHCP/DHCPv6 option. Therefore, you need to configure the address of the connected AC on the fit AP so that the AP can discover and join the AC when the AP and the AC are not in the same subnet.
- The fit AP configuration commands have the same functions as some AP configuration commands used on the AC. When the two configurations conflict with each other, the AP may be re-connected to the AC only based on the configurations on the AC.
- The fit AP configuration commands are automatically saved.

Configuration Steps

▾ Configuring the Static IP Address of the AP

- Optional.
- When IP addresses of APs must be statically planned at the early stage of deployment, you can configure IP addresses on the APs.
- Configure the static IPv4 or IPv6 address of the AP so that the AP can use the IPv4 or IPv6 address to access the AC.
- Run the **apip ipv4** command to configure the static IPv4 address of the AP.
- Run the **apip ipv6** command to configure the static IPv6 address of the AP.

| | |
|------------------------------|---|
| Command | apip ipv4 <i>ip-address</i> <i>network-mask</i> <i>gateway</i> |
| Parameter Description | <i>ip-address</i> : indicates the static IP address. <i>network-mask</i> : indicates the subnet mask. <i>gateway</i> : indicates the gateway address. |
| Defaults | N/A |
| Command Mode | Global configuration mode on the AP |
| Usage Guide | N/A |

| | |
|------------------------------|---|
| Command | apip ipv6 <i>ipv6-address-with-mask</i> <i>gateway</i> |
| Parameter Description | <i>ipv6-address-with-mask</i> : indicates the IPv6 address containing the mask length. The format is X:X:X:X::X/24. <i>gateway</i> : indicates the IPv6 gateway address. |
| Defaults | N/A |

| | |
|---------------------|-------------------------------------|
| Command Mode | Global configuration mode on the AP |
| Usage Guide | N/A |

▾ Configuring the Static IP Address of the AC Accessed by the AP

- Optional.
- When the AP is configured to use the static IP address, you must also specify the IP address of the accessed AC on the AP.
- The static address type of the AC accessed by the AP must be the same as that of the AP. Ensure that both the AC and the AP use the IPv4 static address, or both use the IPv6 static address.
- Run the **acip ipv4** command so that the AP joins a specified IPv4 AC.
- Run the **acip ipv6** command so that the AP joins a specified IPv6 AC.

| | |
|------------------------------|--|
| Command | acipipv4 <i>ip-address</i> [<i>ip-address...</i>] |
| Parameter Description | <i>ip-address</i> : indicates the static IP address. At most six static addresses can be configured. |
| Defaults | N/A |
| Command Mode | Global configuration mode on the AP or AP configuration mode on the AC |
| Usage Guide | N/A |

| | |
|------------------------------|---|
| Command | acipipv6 <i>ipv6-address</i> [<i>ipv6-address...</i>] |
| Parameter Description | <i>ipv6-address</i> : indicates the IPv6 address of the connected AC. At most six static addresses can be configured. |
| Defaults | N/A |
| Command Mode | Global configuration mode on the AP or AP configuration mode on the AC |
| Usage Guide | N/A |

▾ Enabling the AP to Use the Stateless Address

- Optional.
- On the AP, configure data so that the AP uses the IPv6 stateless address auto configuration and a default route is generated.
- Run the **apip ipv6 enable** command to enable the IPv6 function of the AP.

| | |
|------------------------------|---|
| Command | apip ipv6 address autoconfig default |
| Parameter Description | N/A |
| Defaults | N/A |
| Command | Global configuration mode on the AP |

| | |
|--------------------|--|
| Mode | |
| Usage Guide | After this command is executed, the AP uses the IPv6 stateless address auto configuration, and a default route is generated. |

| | |
|------------------------------|---|
| Command | apip ipv6 enable |
| Parameter Description | N/A |
| Defaults | The IPv6 function of the AP is enabled by default. |
| Command Mode | Global configuration mode on the AP |
| Usage Guide | You can run this command to enable or disable the CAPWAP IPv6 discovery function only on an IPv4 network. |

▾ Configuring the CAPWAP IPv6 Discovery Function on the AP

- Optional.
- You can disable the CAPWAP IPv6 discovery function only on an IPv4 network to prevent the attempts made by CAPWAP to set up an IPv6 tunnel, thus reducing the CAPWAP packets on the network.
- Run the **no apip ipv6 enable** command to disable the IPv6 function of the AP.

| | |
|------------------------------|---|
| Command | apip ipv6 enable |
| Parameter Description | N/A |
| Defaults | The IPv6 function of the AP is enabled by default. |
| Command Mode | Global configuration mode on the AP |
| Usage Guide | You can run this command to enable or disable the CAPWAP IPv6 discovery function only on an IPv4 network. |

▾ Enabling the AP to Use the PPPoE Dial-up Mode to Obtain the Address

- Optional.
- When the AP needs to connect to a remote Internet service provider (ISP) through the ADSL and obtains the network access capability, run this command so that the AP can use the PPPoE dial-up mode to obtain the address.

| | |
|------------------------------|---|
| Command | apip pppoe |
| Parameter Description | N/A |
| Defaults | By default, the PPPoE mode is not specified and the AP obtains the address through DHCP. |
| Command Mode | Global configuration mode on the AP |
| Usage Guide | The command configures only the mode (PPPoE dial-up mode) selected by the AP to obtain the address. After this command is configured, you need to add the PPPoE configurations and let the default route to |

point to the dialer interface so that the AP can communicate with the AC.
CAPWAP can only select dialer 1 as the source interface. Therefore, when configuring the PPPoE dial-up mode, dialer 1 must be used.

Verification

- Check whether the fit AP configuration commands exist.
- Check whether the AP can communicate with the AC.

Configuration Example

Configuring the Static IP Address of the AC Accessed by the AP

| | |
|----------------------------|---|
| Configuration Steps | <ul style="list-style-type: none"> ● Configure the static IPv4 address of the AP. ● Configure the static IPv4 address of the AC accessed by the AP. |
| AP | <pre>Ruijie(config)# apip 192.168.1.2 255.255.255.0 192.168.1.1 Ruijie(config)# acip ipv4 1.1.1.1</pre> |
| Verification | <ul style="list-style-type: none"> ● Run the show running-config command to display the configurations. |
| AP | <pre>! apip 192.168.1.2 255.255.255.0 192.168.1.1 acip ipv4 1.1.1.1 !</pre> |

Enabling the AP to Use the PPPoE Dial-Up Mode to Obtain the Address

| | |
|----------------------------|--|
| Configuration Steps | <ul style="list-style-type: none"> ● Enable the AP to select the PPPoE dial-up mode to obtain the address. ● Configure the PPPoE. ● Configure the default route. ● Configure the static IPv4 address of the AC accessed by the AP. |
|----------------------------|--|

| | |
|--------------|--|
| AP | <pre>Ruijie(config)# apip pppoe Ruijie(config)# interface FastEthernet 0/1 Ruijie(config-if-FastEthernet 0/1)#pppoe enable Ruijie(config-if-FastEthernet 0/1)#pppoe-client dial-pool-number 1 no-ddr Ruijie(config-if-FastEthernet 0/1)#exit Ruijie(config)# interfacediaLER 1 Ruijie(config-if-Dialer1)#ip address negotiate Ruijie(config-if-Dialer1)#ppp chap hostname ruijie Ruijie(config-if-Dialer1)#ppp chap password ruijie Ruijie(config-if-Dialer1)#ppp pap sent-username ruijie password ruijie Ruijie(config-if-Dialer1)#dialer pool 1 Ruijie(config-if-Dialer1)#exit Ruijie(config)#ip route 0.0.0.0 0.0.0.0 dialer 1 Ruijie(config)# acip ipv4 1.1.1.1</pre> |
| Verification | <ul style="list-style-type: none"> ● Run the show running-config command to display the configurations. |
| AP | <pre>! apip 192.168.1.2 255.255.255.0 192.168.1.1 acip ipv4 1.1.1.1 !</pre> |

Common Errors

- N/A

2.4.9 Configuring AP Upgrade

Configuration Effect

- Upgrade the AP software version through configuration on the AC.

Notes

- Configure the data to activate the AP software version file. This command loads the **.bin** file to the memory only when the AP needs to be upgraded. When no AP needs to be upgraded, the bin file will be automatically removed from the memory.
- During the adaptive upgrade, the transitional version between rgos10 and rgos11 cannot be used to upgrade an AP using the rgos10 system.

- When the bandwidth is limited, use the bandwidth control function for the upgrade.

Configuration Steps

Creating the AP Product Series

- (Optional) Run the **ap-serial** command to configure an AP product series on the AC.
- To upgrade the AP software version through the AC, you must configure the AP hardware version and product models for a specified product series on the AC.
- An AP software version is applicable to a series of AP products. You can configure the AP hardware version and product models for a specified product series, and use the software version to upgrade specified AP models.

| | |
|---------------------|---|
| Command | ap-serial <i>serial-name ap-pid1 ap-pid2 ... ap-pidn [hw-ver hardware-version]</i> |
| Parameter | <i>serial-name</i> : indicates the name of the AP series to be created. |
| Description | <i>ap-pid1 ap-pid2 ... ap-pidn</i> : lists the product models to be added to the AP series. <i>hardware-version</i> : specifies the AP hardware version. |
| Defaults | No AP series is configured by default. |
| Command Mode | AC configuration mode |
| Usage Guide | - |

Activating the AP Software Version File

- (Optional) Run the **active-bin-file** command to activate an AP software version on the AC.
- To upgrade the AP software version through the AC, you must activate the AP software version on the AC.
- Only an activated AP software version can be used for the upgrade.

| | |
|---------------------|--|
| Command | active-bin-file <i>filename</i> [rgos10] |
| Parameter | <i>filename</i> : specifies the name of a software version. The name may contain a path prefix (flash:tmp: , orusb0:), followed by a real file name. The maximum length of a file name is 64 bytes. |
| Description | rgos10 : indicates that a transitional version between 10.X and 11.X is activated. It is applicable only to the AP software version. |
| Defaults | The AP software version is not activated by default. |
| Command Mode | AC configuration mode |
| Usage Guide | <ol style="list-style-type: none"> 1. To download a software version from the AC to upgrade an AP, you must first activate the version file. The rgos10 system differs a lot from the rgos11 system. Therefore, when using a transitional version between rgos10 and rgos11 for the upgrade, you must add the rgos10 keyword. 2. The .bin file is loaded to the memory only when an AP needs to be upgraded. When no AP needs to be upgraded, the bin file will be automatically removed from the memory. 3. Before configuring this command, ensure that the software version file already exists in the AC system files. |

Upgrading the Version of Specified APs

- Optional: Run the **ap-image** command to use a specified file to upgrade a specified AP series on the AC. This command takes effect on all APs connected to the AC.
- To upgrade the AP software version through the AC, you must first specify the upgrade file used by the AP.
- To upgrade a specified AP series, you must activate the AP software version, specify the AP series, and specify a file for upgrading the specified AP series.

| | |
|------------------------------|--|
| Command | ap-image <i>filename</i> |
| Parameter Description | <i>filename</i> : specifies the software version name. |
| Defaults | N/A |
| Command Mode | AP configuration mode |
| Usage Guide | N/A |

📌 Configuring Adaptive Upgrade

- (Optional) Run the **ap-image auto-upgrade** command so that the AC can automatically identify applicable AP products based on the AP upgrade file and upgrade all applicable APs.
- The command automatically matches the AP models to which the software version is applicable and upgrades these APs.

| | |
|------------------------------|---|
| Command | ap-image { auto-upgrade <i>filename serial-name</i> } |
| Parameter Description | auto-upgrade : indicates that the product model is automatically matched for the upgrade. <i>filename</i> : specifies the software version name. This file name must be the same as that specified by the active-bin-file command. <i>serial-name</i> : indicates the name of the AP series to be upgraded. |
| Defaults | N/A |
| Command Mode | AC configuration mode |
| Usage Guide | You can use the auto-upgrade option to automatically match the software version and upgrade APs without configuring the mapping relationship between the AP product models and software version. You can also use a specified file to upgrade a specified AP product series. When both the automatic upgrade mode and the specified series upgrade mode exist, the specified series upgrade mode is used preferentially. To enable the AC to upgrade the version of a specified AP product series, you must create the AP product series, configure the software version corresponding to the specified APs, and activate the software version. The three steps are mandatory. |

📌 Configuring the Maximum Number of APs that can be Concurrently Upgraded by the AC

- Optional.
- Limit the maximum number of APs that can be concurrently upgraded by the AC.

| | |
|------------------|---|
| Command | capwapupgrade max-concurrent <i>num</i> |
| Parameter | <i>num</i> : indicates the maximum number of APs that can be concurrently upgraded by the AC. The default value |

| | |
|---------------------|--|
| Description | is 18. The value ranges from 1 to 200. |
| Defaults | 15 |
| Command Mode | AC configuration mode |
| Usage Guide | N/A |

↘ Creating an Upgrade Group

- Optional.
- Create an upgrade group. The AC can evenly distribute the centralized upgrade quota to the upgrade group through balanced scheduling to limit the bandwidth and avoid wasting the bandwidth.

| | |
|------------------------------|--|
| Command | capwap upgrade group <i>group-name</i> [max-concurrent <i>num</i>] |
| Parameter Description | <i>group-name</i> : indicates the name of an upgrade group. The upgrade group name cannot be set to "default". <i>num</i> : indicates maximum number of APs that can be concurrently upgraded in the group. The default value is 5. The value ranges from 1 to 200. |
| Defaults | By default, no upgrade group is configured, and the AP upgrade is not limited by the bandwidth. When configuring an upgrade group, the maximum number of APs that can be concurrently upgraded in the group is 5 by default. |
| Command Mode | AC configuration mode |
| Usage Guide | N/A |

↘ Adding APs to an Upgrade Group

- Optional.
- Add APs to an upgrade group. Limit the number of APs that are upgraded in a centralized manner in this group through scheduling and configuration to control the bandwidth by upgrade group.

| | |
|------------------------------|---|
| Command | ap-upgrade group <i>group-name</i> |
| Parameter Description | <i>group-name</i> : indicates the name of the upgrade group. Before adding APs to an upgrade group, you must run the capwap upgrade group command to create the upgrade group. |
| Defaults | APs are not added to any upgrade group. |
| Command Mode | AP configuration mode |
| Usage Guide | N/A |

↘ Configuring the Bandwidth Used for AP Upgrade

- Optional.
- Configure the bandwidth used for AP upgrade.

| | |
|------------------------------|--|
| Command | ap-upgrade band-width <i>num</i> |
| Parameter Description | <i>num</i> : indicates the bandwidth used for AP upgrade. The unit is 1 KB. The value ranges from 8 to 1024. |

| | |
|---------------------|--|
| Defaults | The bandwidth is not limited. |
| Command Mode | AP configuration mode |
| Usage Guide | The bandwidth-limited AP upgrade configuration commands include the command for configuring the bandwidth used for AP upgrade, the command for creating an upgrade group, and the command for adding APs to the upgrade group. |

Verification

- Check whether the AP version is successfully upgraded.
- Check the upgrade status of the bandwidth control upgrade group and APs in the group.

Configuration Example

Configuring the AP Upgrade Data

| | |
|----------------------------|--|
| Configuration Steps | <ul style="list-style-type: none"> ● Enter the AC configuration mode on the AC. ● Create the name of an AP product series on the AC. ● Activate the specified AP software version used for the upgrade on the AC. ● Configure the AP upgrade version file on the AC. |
| AC | <pre>Ruijie(config-ac)# ap-serial serial1 AP220-E AP220-SE AP620-H hw-ver 1.0 Ruijie(config-ac)# active-bin-file ap.bin Ruijie(config-ac)# ap-image ap.bin serial1 Ruijie(config-ac)# exit</pre> |
| Verification | <ul style="list-style-type: none"> ● Display the list of files activated on the AC. |
| AC | <pre>Ruijie#show ac-config active-file Cnt File Name Version Used Cnt Ready ----- 1 ap.bin RGOS 10.4 (1t7) (1T7), Release (88888) 1 1</pre> |

Configuring the AP Upgrade During Which the Bandwidth is Under Control

| | |
|----------------------------|---|
| Configuration Steps | <ul style="list-style-type: none"> ● Enter the AC configuration mode on the AC. ● Create an AP upgrade group on the AC. ● Exit from the AC configuration mode. ● Enter the AP configuration mode. ● Configure the specified AP upgrade group on the AC. ● Activate the bandwidth used for AP upgrade on the AC. |
|----------------------------|---|

| | |
|---------------------|---|
| AC | <pre>Ruijie(config-ac)# capwap upgrade group UPGRADE-GROUP1 max-concurrent 10 Ruijie(config-ac)# exit Ruijie(config)#ap-config 8832.0000.1111 Ruijie(config-ap)# ap-upgrade group UPGRADE-GROUP1 Ruijie(config-ap)# ap-upgrade band-width 128 Ruijie(config-ap)# exit</pre> |
| Verification | <ul style="list-style-type: none"> ● Display the upgrade group and APs in the group on the AC. ● Display the APs and their bandwidths in an upgrade group on the AC. |
| AC | <pre>Ruijie#show ac-config upgrade-group Cnt Group-Name Max-Concurrent Token cnt Upgrading cnt ----- 1 UPGRADE-GROUP1 10 2 1 Ruijie#show ac-config upgrade-groupUPGRADE-GROUP1 Group have 2 ap, online 1 offline 1 Cnt Ap-Name Ap-Mac Online Upgrade Band-width ----- 1 ap220e 8832.0000.1111 true true 128 2 ap330 - false false 128 Ruijie#show ap-config wtp-info 8832.0000.1111 Ruijie#show ap-config wtp-info ap220e Upgrade-banfwidth : 128 Upgrade group : UPGRADE-GROUP1</pre> |

Common Errors

- The AP upgrade data is configured, but the software version file used for the upgrade does not exist in the AC system files.

2.4.10 Configuring a Mini AP

Configuration Effect

- One rack-type AP can carry multiple mini APs. This operation is performed to manage and name mini APs, and display their installation status, thus facilitating the mini AP management.

Notes

- N/A

Configuration Steps

↳ Naming a Mini AP

- (Optional) Run the **slot** command to name a mini AP in a specified slot.
- This configuration takes effect only for i-Share APs. The corresponding radio frequency (RF) card can be named to determine the position of this card.

| | |
|------------------------------|---|
| Command | slot <i>slot-id slot-name</i> [secondary] mac <i>mac-address slot-name</i> } |
| Parameter Description | <p><i>slot-id</i>: indicates the slot ID. The slot ID ranges from 1 to 24.</p> <p><i>slot-name</i>: indicates the name of an AP card. The name is a string of 1 to 63 characters, and cannot contain any space.</p> <p>secondary: indicates the secondary mini AP.</p> <p><i>mac-address</i>:: indicates the MAC address of the mini AP.</p> |
| Defaults | An AP card is not named by default. |
| Command Mode | AP configuration mode |
| Usage Guide | <p>This command takes effect only on a rack-type AP, and cannot be used in all AP configuration mode.</p> <p>If you want to name the secondary mini AP, please add the secondary parameter.</p> |

↳ Updating the Installation Status of Mini APs

- (Optional) Run the **install update** or **uninstall** command to update the installation status of mini APs.
- If the state of a removed mini AP is displayed as offline, you can update its installation status.

| | |
|------------------------------|---|
| Command | install update |
| Parameter Description | N/A |
| Defaults | N/A |
| Command Mode | AP configuration mode |
| Usage Guide | <p>If a mini AP is installed in a specified slot on the rack-type AP but is later manually removed, the system determines that this mini AP is offline. This command is executed to query a rack-type AP that is currently online, and the online mini APs on the rack are treated as installed mini APs. Configurations of this command are not saved.</p> |

| | |
|------------------------------|--|
| Command | uninstall <i>slot-id</i> [secondary] |
| Parameter Description | <i>slot-id</i> : indicates the slot ID. The slot ID ranges from 1 to 24. secondary : indicates the secondary mini AP. |
| Defaults | N/A |
| Command Mode | AP configuration mode |
| Usage Guide | If a mini AP is installed in a specified slot on the rack-type AP but is later manually removed, the system determines that this mini AP is offline. You can use this command to remove a mini AP from the corresponding slot. If the mini AP in this slot is online, execution of this command is meaningless. Configurations of this command are not saved. In addition, the command cannot be used in all AP configuration mode. If you want to remove the secondary mini AP, please add the secondary parameter. |

↘ Restarting a Mini AP

- (Optional) Run the **reset slot** *slot-id* command to restart a mini AP in a specified slot.
- To reset a mini AP, you can use this command to power off the mini AP and then power it on again.

| | |
|------------------------------|--|
| Command | reset slots <i>slot-id</i> |
| Parameter Description | <i>slot-id</i> : indicates the slot ID. The slot ID ranges from 1 to 24. |
| Defaults | N/A |
| Command Mode | AP configuration mode |
| Usage Guide | This command takes effect only on a rack-type AP, and cannot be used in all AP configuration mode. Configurations of this command are not saved. |

Verification

- Check the installation information of mini APs, including the names and online status.

Configuration Example

↘ Naming a Mini AP

| | |
|-----------------------------------|--|
| <p>Configuration Steps</p> | <ul style="list-style-type: none"> ● Enter the AP configuration mode on the AC. ● Name the mini AP in a specified slot. |
| <p>AC</p> | <pre>Ruijie(config)# ap-config AP0001 Ruijie(config-ap)# slot 1 Dormitory 1#101</pre> <ul style="list-style-type: none"> ● Name the secondary mini AP in a specified slot. <pre>Ruijie(config)# ap-config AP0001 Ruijie(config-ap)# slot 1 1#102 secondary</pre> <ul style="list-style-type: none"> ● The following example sets the name of mini AP with MAC address 0001.0001.0002 to 1#102 <pre>Ruijie(config)# ap-config AP0001 Ruijie(config-ap)# slot 1 mac 0001.0001.0001 1#101 Ruijie(config-ap)# slot 1 mac 0001.0001.0002 1#102</pre> |
| <p>Verification</p> | <ul style="list-style-type: none"> ● Check the name of the mini AP on the AC. |
| <p>AC</p> | <pre>Ruijie#show ap-config summary slot Total Install Number: 2 Total Online Number: 1 Total Offline Number: 1 AP(AP0001)'s Slots Information Install Number: 2 Online Number: 1 Offline Number: 1 AP mac Slot ID Role Slot Name Model Slot Mac Radio Radio Up/Off time State ----- 00d0.f822.3418 1 master Dormitory 1#101 MAP552 5869.6c36.e268 1 E 0 6* 100 2 E 0 157* 100 1:03:39:38 online 00d0.f822.3418 2 slave Dormitory 1#102 MAP552 5869.6c36.e269 3 N 4 N 1:03:39:38 offline</pre> |

Common Errors

- N/A

2.4.11 Configuring the CAPWAP Control Address

Configuration Effect

- Configure the address used by the AC to set up a CAPWAP tunnel.

Notes

- When modifying the IP address of the CAPWAP tunnel of an AC, online APs may be forced to go offline.
- If an address that does not exist on the AC is configured, the CAPWAP tunnel cannot be set up.
- If the AP gateway is not deployed on the AC (that is, both the AC and the AP are deployed at L3), the option of the AP address pool must be set to the address (if any) configured by using the **capwap ctrl-ip** command.
- In the AC hot backup environment, if this command is used to configure the control address of the CAPWAP tunnel, the **peer-ip A.B.C.D** command must be executed in the hot backup configuration mode on the peer standby AC to configure this control address as the peer control IP address.

Configuration Steps

- (Optional) This command is used when the address of a non-loopback interface must be used as the CAPWAP control address.
- When configuring the IPv4 control address for a CAPWAP tunnel between the AC and the AP, you can specify the IP address so that the AC uses this IP address to set up a CAPWAP tunnel with the AP.
- Run the **capwap ctrl-ip ip-address** command to specify the control address used for setting up a CAPWAP tunnel with the AP. *ip-address* must be the IP address of an interface on the AC device.

| | |
|------------------------------|--|
| Command | capwap ctrl-ip ip-address |
| Parameter Description | <i>ip-address</i> : indicates the address used by the AC to set up a CAPWAP tunnel. The IP interface of the loopback0 interface is used by default. |
| Defaults | By default, the IPv4 address of the first loopback interface on the AC device is used to set up a CAPWAP tunnel between the AC and the AP. |
| Command Mode | AC configuration mode |
| Usage Guide | By default, the AC uses the IP address of the first loopback interface to set up a CAPWAP tunnel. This command allows you to manually specify the IP address used by the AC to set up a CAPWAP tunnel with the AP. |

Verification

- Run the **show running-config** command to check whether the configuration is successful.

Configuration Example

Setting the Control IP Address of the AC to 10.0.0.1

| | |
|----------------------|--|
| Configuration | <ul style="list-style-type: none"> ● Enter the AC configuration mode. |
|----------------------|--|

| | |
|---------------------|--|
| Steps | <ul style="list-style-type: none"> Configure the AC location information. |
| AC | <pre>Ruijie(config)#ac-controller Ruijie(config-ac)#capwap ctrl-ip 10.0.0.1</pre> |
| Verification | Use the show running-config command to display the configurations. |
| AC | <pre>! ac-controller capwap ctrl-ip 10.0.0.1 !</pre> |

Common Errors

- N/A

2.4.12 Configuring CAPWAP Fragmentation

Configuration Effect

- After a packet is encapsulated on the CAPWAP tunnel, the packet length may exceed the IP MTU, and will be fragmented at the IP layer. When the IP MTUs of multiple nodes on the link are inconsistent, the packet may be fragmented and reassembled for several times, which reduces the packet forwarding performance. After CAPWAP fragmentation is enabled, the packet will be fragmented when encapsulated on the CAPWAP channel. The CAPWAP packet length is specified as the minimum IP MTU on the link, thereby avoiding fragmentation at the IP layer.

Notes

- If the configured MTU is too small, a lot of fragmented packets will be generated, affecting the packet forwarding performance. Even worse, large packets may fail to be transmitted. Therefore, it is important to determine the size of the MTU.
- The configured CAPWAP MTU must be equal to or smaller than the IP MTU at the egress of the device; otherwise, IP fragmentation will be performed after CAPWAP fragment. The minimum IPv6 MTU is 1280, that is, the minimum path MTU is 1280. Therefore, the CAPWAP MTU must be equal to or greater than 1280.

Configuration Steps

▾ Configuring the Path MTU of the CAPWAP Tunnel

- (Optional) Enter the AP or AP group configuration mode, and run the **capwap mtu** command to configure the path MTU of the CAPWAP tunnel.
- If the length of the packet encapsulated on the CAPWAP tunnel exceeds the path MTU of the CAPWAP tunnel, the packet will be fragmented on the CAPWAP tunnel. When configuring the path MTU of the CAPWAP tunnel on the AC,

this path MTU must be set to the minimum IP MTU on the tunnel; otherwise, IP fragmentation and reassembly are performed again during packet forwarding, reducing the forwarding performance.

| | |
|------------------------------|---|
| Command | capwap mtu num |
| Parameter Description | <i>num</i> : indicates the path MTU of the CAPWAP tunnel. The value ranges from 68 to 1500. The unit is byte. |
| Defaults | The default size of the MTU is 1500 bytes. |
| Command Mode | AP configuration mode or AP group configuration mode |
| Usage Guide | - |

↘ Enabling CAPWAP Fragmentation

- Optional.
- When multiple IP MTU nodes exist on the transmission network, it is recommended that CAPWAP fragmentation be enabled on the AC, and the CAPWAP MTU be set to the path MTU.
- After a packet is encapsulated on the CAPWAP tunnel, the packet length may exceed the IP MTU, and will be fragmented at the IP layer. When the IP MTUs of multiple nodes on the link are inconsistent, the packet may be fragmented and reassembled for several times, which reduces the packet forwarding performance. You can run this command to enable CAPWAP fragmentation. After this function is enabled, the packet will be fragmented when encapsulated on the CAPWAP channel. The CAPWAP packet length can be specified in the **capwap mtu** command as the minimum IP MTU on the link, thereby avoiding fragmentation at the IP layer.

| | |
|------------------------------|--|
| Command | capwap fragment enable |
| Parameter Description | - |
| Defaults | CAPWAP fragmentation is disabled by default. |
| Command Mode | AP configuration mode or AP group configuration mode |
| Usage Guide | N/A |

Verification

- Check the detailed information about the CAPWAP to learn the MTU of the CAPWAP tunnel and whether the fragmentation function is enabled.
- Alternatively, run the **show ap-config running** command to check whether CAPWAP fragmentation is configured.

Configuration Example

↘ Configuring the MTU of AP1 and Enabling the Fragmentation Function

| | |
|----------------------------|---|
| Configuration Steps | <ul style="list-style-type: none"> ● Set the path MTU of AP1 to 1200 bytes on the AC. ● Enable CAPWAP fragmentation of AP1 on the AC. |
|----------------------------|---|

| | |
|---------------------|---|
| AC | <pre>Ruijie(config)# ap-config AP1 Ruijie(config-ap)# capwap mtu 1200 Ruijie(config-ap)# capwap fragment enable</pre> |
| Verification | Use the show ap-config running command to display the configurations. |
| AC | <pre>! capwap fragment enable capwap mtu 1200 !</pre> |

Common Errors

- N/A

2.4.13 Configuring CAPWAP Encryption

Configuration Effect

- Enable the encryption function on the CAPWAP data channel to improve security of the WLAN.
- Disable the encryption function on the CAPWAP control channel to analyze packets when the network is faulty.

Notes

- When the encryption mode of the data channel is changed, the CAPWAP tunnel will be re-established.

Configuration Steps

📌 Configuring the Encryption Function on the CAPWAP Data Channel

- (Optional) Enter the AP or AP group configuration mode, and run the **capwap data-tunnel encryption** command to enable encryption on the CAPWAP data channel.
- Encryption is disabled on the CAPWAP data channel by default. When the transmission links of both the AC and the AP are deployed on the public transmission network, the data may be intercepted or tampered with. On the AC, enabling encryption on the CAPWAP data channel can ensure transmission security of users' data packets.
- enabling encryption on the data channel can ensure security of interaction between the AC and the AP.

| | |
|------------------------------|--|
| Command | capwap data-tunnel encryption {bf des}key |
| Parameter Description | <i>key</i> : indicates the shared key, which ends with a space. The maximum length of the key is 255 characters. |
| Defaults | Encryption is disabled on the CAPWAP data channel by default. |
| Command Mode | AP configuration mode or AP group configuration mode |
| Usage Guide | N/A |

▾ Configuring the Encryption Function on the CAPWAP Control Channel

- Optional.
- On the AC, you can disable the encryption function on the CAPWAP control channel to analyze packets for troubleshooting purpose when the network is faulty.

| | |
|------------------------------|---|
| Command | capwap dtls enable |
| Parameter Description | - |
| Defaults | By default, the DTLS encryption function is enabled on the CAPWAP control channel. |
| Command Mode | AC configuration mode |
| Usage Guide | By default, the DTLS encryption function is enabled on the CAPWAP control channel to ensure security of interaction between the AC and the AP. In special cases, you can disable the encryption function on the CAPWAP control channel to facilitate tests. |

Verification

- Check the detailed information about the CAPWAP tunnel to determine the encryption policy of the control channel and the data channel.
- Run the **show running-config** command to check whether encryption is enabled on the control channel.

Configuration Example

▾ Enabling Encryption on the AP Data Channel and Disabling Encryption on the Control Channel

| | |
|----------------------------|--|
| Configuration Steps | <ul style="list-style-type: none"> ● On the AC, enable the AP to use the DES encryption algorithm to encrypt packets on the data channel, and set the key to ruijie. ● On the AC, disable the encryption function on the AP control channel. |
| AC | <pre>Ruijie(config-ap)# capwap data-tunnel encryption des ruijie Ruijie(config-ap)# no capwap dtls enable</pre> |
| Verification | <ul style="list-style-type: none"> ● On the AC, check the CAPWAP tunnel information. ● On the AC, run the show running-config command to check whether the encryption function is disabled on the control channel. |
| AC | <pre>Ruijie# showcapwap detail CAPWAP process "capwap 1" with state [Run] Process uptime is 0 days 0 hours 0 minutes 43 seconds Echo interval is 30 secs, Dead interval is 81 secs Current timers echo interval Peer address is 10.10.10.2</pre> |

```
Peer address6 is ::
Peer control port is 10000, data port is 10001
My address is 1.1.1.1
My address6 is ::
The MAC of AP is 001a.a94e.de9d
The Session ID of AP is 001aa94e.de9d8ab5.11818ab5.11818ab5
Capwap fragment is disable
The Path MTU is 1500
Recent received request's sequence number 7
Recent received response's sequence number 3
Recent send request's sequence number 3
Retransmit Count 0, Discovery Count 0, Failed DTLS Session Count 0
Sending queue length 0, Receive queue length 0
Data crypt capacity BF and DES
Data crypt type plain
Ruijie#show running-config
!
no capwap dtls enable
```

Common Errors

- N/A

2.4.14 Configuring CAPWAP Access Control

Configuration Effect

- Configure the maximum number of APs that can concurrently go online.

Notes

- If the configured value is too small, the total online duration of all APs connected to the AC will be relatively long.

Configuration Steps

▾ Configuring the Maximum Number of APs That Can Concurrently Go Online

- Optional.
- On the AC, configure the maximum number of APs that can concurrently go online to prevent an excessively high CPU usage caused by a large number of CAPWAP control packets.

| | |
|------------------------------|--|
| Command | capwap max-concurrent <i>num</i> |
| Parameter Description | <i>num</i> : indicates the maximum number of APs that can concurrently go online. The number ranges from 1 to 200. |
| Defaults | 50 |
| Command Mode | AC configuration mode |
| Usage Guide | If a large number of APs go online concurrently, the CPU usage of the AC may increase or even reach 100%. Consequently, tunnels of APs that are already online will be disconnected due to keepalive failures. You can use this command to limit the maximum number of APs go online concurrently. |

✚ Configuring the Number of CAPWAP Discovery Packets That Can Be Processed by an AC

- Optional.
- Configure the maximum number of discovery packets that can be processed by an AC on the AC to prevent exceedingly high CPU usage caused by considerable CAPWAP control packets.
- Run the **capwap disc-concurrent** *num* command to configure the number of discovery packets that can be processed.

| | |
|------------------------------|--|
| Command | capwap disc-concurrent <i>num</i> |
| Parameter Description | The number of discovery packets that can be processed per second depends on the product capacity. |
| Defaults | The default value varies with the capacity value, for example, the default value is 256 for the WS7800. |
| Command Mode | AC global configuration mode |
| Usage Guide | The CAPWAP module needs to restrict the discovery packet processing concurrency based on the AC capacity, to prevent discovery packet attacks. |

Verification

- Run the **show running-config** command to display the configurations.

Configuration Example

✚ Configuring the Maximum Number of APs That Can Concurrently Go Online

| | |
|----------------------------|--|
| Configuration Steps | <ul style="list-style-type: none"> ● On the AC, configure the maximum number of APs that can concurrently go online. |
| AC | <pre>Ruijie(config-ac)#capwap max-concurrent 100</pre> |
| Verification | <ul style="list-style-type: none"> ● On the AC, run the show running-config command to display the configurations. |

| | |
|-----------|--|
| AC | <pre>! ac-controller capwap max-concurrent 100 !</pre> |
|-----------|--|

Common Errors

- N/A

2.4.15 Configuring the Echo Interval of the CAPWAP Tunnel

Configuration Effect

- (Optional) Configure the interval at which a keepalive packet is set.

Notes

- During deployment of the wireless network, the echo interval of the CAPWAP tunnel can be adjusted according to the network scale to properly plan the network convergence performance. During the adjustment, ensure that you have a good understanding about the network scale and confirm that the convergence is necessary. If a low echo interval is configured on a wireless network where a large number of APs are deployed, the network environment will be affected.

Configuration Steps

- (Optional) Enter the AP or AP group configuration mode for configuration.
- Configure the echo interval of the CAPWAP tunnel on the AC to control the keepalive period of the CAPWAP tunnel.

| | |
|------------------------------|--|
| Command | echo-interval <i>seconds</i> |
| Parameter Description | <i>seconds</i> : indicates the echo interval of the CAPWAP tunnel. The value ranges from 5 to 255. |
| Defaults | 30s |
| Command Mode | AP configuration mode or AP group configuration mode |
| Usage Guide | In a fit AP network structure, an AC is interconnected with an AP through the CAPWAP tunnel. The Echo Request and Echo Response packets are used between the AP and the AC to maintain the effectiveness of links. If other request packets are not transmitted, the AP sends an Echo Request packet to the AC at the interval specified by echo-interval to keep the CAPWAP tunnel alive. If the AP does not receive any Echo Response packet, the Echo Request packet will be retransmitted. The transmission interval starts at the initial transmission interval (3s or half of echo-interval , whichever the smaller), and then is doubled upon next retransmission. The maximum retransmission interval cannot exceed the half of echo-interval or 60s, whichever the smaller. If the AP does not receive the Echo Response packet when max-retransmit (the maximum retransmission times) is reached, it is determined that the CAPWAP tunnel is disconnected. That is, the keepalive failure time of the tunnel is equal to the keepalive time plus the retransmission interval. This |

command takes effect only when the tunnel is in Run state. By default, **echo-interval** is 30s, and **max-retransmit** is 5. If the Echo Response packet is not received 0s after the Echo Request packet is sent, the Echo Request packet will be retransmitted at the interval of 3s, 6s, 12s, 15s, and 15s, respectively. The same rule is observed to calculate the packet timeout time if **echo-interval** and **max-retransmit** are set to other values.

Verification

- Check the detailed information about the CAPWAP tunnel. The modified interval at which the keepalive packet is sent should be displayed.

Configuration Example

📌 **Configuring the Echo Interval of the CAPWAP Tunnel**

| | |
|----------------------------|--|
| Configuration Steps | <ul style="list-style-type: none"> ● On the AC, set the echo interval of the CAPWAP tunnel to 50s. |
| AC | <pre>Ruijie(config)#ap-config AP0001 Ruijie(config-ap)# echo-interval 50</pre> |
| Verification | <ul style="list-style-type: none"> ● On the AC, check the detailed information about the CAPWAP tunnel. |
| AC | <pre>Ruijie#show capwap 1.1.1.1 detail Echo interval is 50 secs, Dead interval is 119 secs</pre> |

Common Errors

- N/A

2.4.16 Configuring the Maximum Retransmission Times of a CAPWAP Packet

Configuration Effect

- (Optional) Configure the maximum transmission times of a CAPWAP packet to adjust the keepalive time of the CAPWAP tunnel.

Notes

N/A

Configuration Steps

- (Optional) Enter the AP or AP group configuration mode for configuration.
- Configure the maximum transmission times of a CAPWAP packet to adjust the keepalive time of the CAPWAP tunnel.

| | |
|------------------|--|
| Command | capwap max-retransmit <i>num</i> |
| Parameter | <i>num</i> : indicates the maximum retransmission times of a CAPWAP packet |

| | |
|---------------------|--|
| Description | |
| Defaults | 5 |
| Command Mode | AP configuration mode or AP group configuration mode |
| Usage Guide | If the AP does not receive any Echo Response packet after sending an Echo Request packet, the Echo Request packet will be retransmitted. The transmission interval starts at the initial transmission interval (3s or half of echo-interval , whichever the smaller), and then is doubled upon next retransmission. The maximum retransmission interval cannot exceed the half of echo-interval or 60s, whichever the smaller. If the AP does not receive the Echo Response packet when max-retransmit (the maximum retransmission times) is reached, it is determined that the CAPWAP tunnel is disconnected. You can configure the maximum transmission times of a CAPWAP packet to adjust the keepalive time of the CAPWAP tunnel. This command takes effect only when the tunnel is in Run state. |

Verification

- Check the detailed information about the CAPWAP tunnel. The modified interval at which the keepalive packet is sent should be displayed.

Configuration Example

Configuring the Maximum Retransmission Times of a CAPWAP Packet

| | |
|----------------------------|--|
| Configuration Steps | <ul style="list-style-type: none"> ● Set the maximum retransmission times of AP1 to 20. |
| AC | <pre>Ruijie(config)#ap-config AP1 Ruijie(config-ap)# capwap max-retransmit 20</pre> |
| Verification | <ul style="list-style-type: none"> ● On the AC, check the detailed information about the CAPWAP tunnel. |
| AC | <pre>Ruijie#show capwap 1.1.1.1 detail Config maxretransmit 20</pre> |

Common Errors

- N/A

2.4.17 Configuring the AC Discovery Mode

Configuration Effect

- An AP can send discovery packets of a recommended type, DHCP packets, DNS packets, packets carrying the statically configured AC IP address, and packets of other types (for example, broadcast and multicast packets) to an AC. An AC can be configured to respond only to certain types of discovery packets. Only APs receiving responses from an AC can perceive that the AC is valid, and these APs can establish CAPWAP tunnels to the AC.

Notes

- If the AC discovery mode is set to supporting none of the discovery packets, an AP cannot connect to an AC using discovery packets.

Configuration Steps

▾ Configuring AC Discovery via a Recommended Type of Discovery Packets

- Optional.

| | |
|---------------------|---|
| Command | capwap discovery-type ac-referral { allow forbidden } |
| Parameter | allow: indicates that this type of discovery packets can be used to discover an AC. |
| Description | forbidden: indicates that this type of discovery packets cannot be used to discover an AC. |
| Defaults | An AP can send discovery packets of a recommended type to discover an AC by default. |
| Command Mode | AC configuration mode |
| Usage Guide | N/A |

▾ Configuring AC Discovery via Discovery Packets

- Optional.
- After this command is configured, configurations of other discovery types will be overwritten.

| | |
|---------------------|--|
| Command | capwap discovery-type all { allow forbidden } |
| Parameter | allow: indicates that discovery packets can be used to discover an AC. |
| Description | forbidden: indicates that discovery packets cannot be used to discover an AC. |
| Defaults | An AP can send discovery packets to discover an AC by default. |
| Command Mode | AC configuration mode |
| Usage Guide | N/A |

▾ Configuring AC Discovery via DHCP Packets

- Optional.

| | |
|---------------------|--|
| Command | capwap discovery-type dhcp { allow forbidden } |
| Parameter | allow: indicates that DHCP packets can be used to discover an AC. |
| Description | forbidden: indicates that DHCP packets cannot be used to discover an AC. |
| Defaults | An AP can send DHCP packets to obtain the AC address and discover the AC by default. |
| Command Mode | AC configuration mode |
| Usage Guide | N/A |

▾ Configuring AC Discovery via DNS Packets

- Optional.

| | |
|----------------|--|
| Command | capwap discovery-type dns { allow forbidden } |
|----------------|--|

| | |
|---------------------|---|
| Parameter | allow: indicates that DNS packets can be used to discover an AC. |
| Description | forbidden: indicates that DNS packets cannot be used to discover an AC. |
| Defaults | An AP can send DNS packets to obtain the AC address and discover the AC by default. |
| Command Mode | AC configuration mode |
| Usage Guide | N/A |

▾ Configuring AC Discovery via Packets Carrying the Statically Configured AC IP Address

- Optional.

| | |
|---------------------|---|
| Command | capwap discovery-type static-config { allow forbidden} |
| Parameter | allow: indicates that packets carrying the statically configured AC IP address can be used to discover an AC. |
| Description | forbidden: indicates that packets carrying the statically configured AC IP address cannot be used to discover an AC. |
| Defaults | An AP can send packets carrying the statically configured AC IP address to discover the AC by default. |
| Command Mode | AC configuration mode |
| Usage Guide | N/A |

▾ Configuring AC Discovery via Discovery Packets of Other Types

- Optional.
- Configure other AC discovery modes, such as the broadcast or multicast mode.

| | |
|---------------------|---|
| Command | capwap discovery-type unknown { allow forbidden} |
| Parameter | allow: indicates that broadcast or multicast discovery packets can be used to discover an AC. |
| Description | forbidden: indicates that broadcast or multicast discovery packets cannot be used to discover an AC. |
| Defaults | An AP can send broadcast or multicast packets to discover an AC by default. |
| Command Mode | AC configuration mode |
| Usage Guide | N/A |

2.5 Monitoring

Displaying

| Description | Command |
|---|--------------------------------------|
| Displays the list of files activated on the AC. | show ac-config active-file |
| Displays the mapping between AP product series configured on the AC and product models, and files used to upgrade the product series. | show ac-config serial-product |

| Description | Command |
|--|---|
| Displays the information about the upgrade group configured on the AC. | <code>show ac-config upgrade-group [<i>group-name</i>]</code> |
| Displays the data on the master board of the AP. | <code>show ap-config board-data <i>ap-name</i></code> |
| Displays the status of links between ACs and APs. | <code>show ap-config link-latency { all single <i>ap-name</i> }</code> |
| Displays the AP vendor information. | <code>show ap-config inventory <i>ap-name</i></code> |
| Displays the AP restart statistics | <code>show ap-config reboot <i>ap-name</i></code> |
| Displays the mini AP information of a specified AP | <code>show ap-config slot</code> |
| Displays the static IP address of an AP | <code>show ap-config static-ip{ all single <i>ap-name</i> }</code> |
| Displays the AP location information | <code>show ap-config summary location</code> |
| Displays the mini AP information of all APs | <code>show ap-configsummary slot</code> |
| Displays the AP upgrade status | <code>show ap-config updating-list</code> |
| Displays the AP status descriptions | <code>show ap-config wtp-descriptor <i>ap-name</i></code> |
| Displays the AP status information | <code>show ap-config wtp-info <i>ap-name</i></code> |
| Displays the detailed information about the CAPWAP tunnel | <code>show capwap [<i>index</i> [<i>ip-address</i> [<i>port</i>]]] detail</code> |
| Displays the status of the CAPWAP tunnel | <code>show capwap state</code> |
| Displays the CAPWAP tunnel statistics | <code>show capwap [<i>index</i> [<i>ip-address</i> [<i>port</i>]]] statistics</code> |
| Displays the AP version information | <code>show version { all <i>ap-name</i> }</code> |
| Collects and displays various logs on an AP | <code>tran-data-start <i>ap-name</i> {exception memory tech-support tech-package}</code> <code>tran-data-show <i>ap-name</i> {exception cpuinfo memory syslog tech-support}</code> |
| Displays all downlink ports of i-Share+ APs | <code>show ap-config summary slot interface</code> |

3 Configuring STA Management

3.1 Overview

STA Management (STAMG) implements station (STA) management, including STA access control management and STA event notification. Event notification is mainly used to serve other function modules. Applications of the STAMG functions are as follows:

- The dynamic blacklist is used on a security-sensitive network to prevent user attacks.
- The STA limit is used when the number of STAs exceeds the AP capacity.
- Load balancing is used when STAs need to be evenly distributed to multiple APs.
- Association control is used in the E-bag scenario.

Protocols and Standards

- N/A

3.2 Applications

N/A

3.3 Features

Overview

| Feature | Description |
|-------------------------------------|--|
| Association Control | Associates secondary STAs with APs in the same control zone if the primary STA is associated with these APs. |

3.3.1 Inter-Radio Load Balancing

Inter-radio load balancing can balance the load among radios of the same AP to prevent overload of a single radio. Similarly, the load here can be the traffic or the number of associated STAs.

Working Principle

The principle of inter-radio load balancing is similar to that of load balancing group except that you can configure the load balancing thresholds respectively for intra-frequency radios (2.4 GHz or 5 GHz) or inter-frequency radios. If all the radios of an AP are in the same frequency, the intra-frequency configuration takes effect; otherwise, the inter-frequency configuration takes effect.

3.3.2 Association Control

Association control is a method for controlling association behaviors of wireless STAs. STAs are divided into two groups. In each group, only one STA is defined as the primary STA, and the other STAs are defined as secondary STAs. The secondary STAs must follow the association behaviors of the primary STA. That is, the primary and secondary STAs must be associated with the same wireless network. In this way, association behaviors of wireless STAs can be properly controlled.

Working Principle



The coverage area of a wireless network is divided into several association control zones. One or several APs are deployed in each zone, and wireless terminals are divided into groups. The control zones that can be associated with the terminals are strictly controlled. For example, a school has many classrooms, and a wireless AP is deployed in each classroom. Radio signals travel in the space. When E-bags are used in two adjacent classrooms at the same time, the ideal condition is that all the teacher and student terminals are associated with the AP of their own classrooms so that the two classrooms will not interfere with each other. In this case, a classroom must be defined as an association control zone and all the teacher and student terminals in a classroom must be associated with the AP of the classroom.

Association control aims to prevent terminals from associating with a wireless network at random when multiple wireless networks are available for selection. The following are prerequisites for network configurations:

- Based on the pre-configured association control zones and package information, the AC pushes the information about primary STAs in all packages to all APs in the association control zones and generates a whitelist of primary STAs on these APs.
- The information about primary STAs in all packages is available in the AP whitelist. Therefore, before the association control function is enabled, the primary STA must associate itself with the corresponding SSID in the specified control zone. After that, the AC pushes all corresponding secondary STAs to all APs in the association control zone and generates a whitelist according to the configuration of the primary STA package to allow the secondary STAs to associate themselves with the control zone.
- When the primary STA is de-associated from the control zone, all the secondary STAs will also be de-associated and deleted from the AP whitelist.
- The above process can be summarized as follows: The secondary STAs must follow the primary STA to associate themselves with an AP in the same control zone, with which the primary STA is associated. Only the APs of this control zone have a whitelist of the corresponding secondary STAs. This ensures that STAs are not randomly associated with APs.

3.4 Configuration

| Configuration | Description and Command | |
|--|--|--|
| Configuring Inter-Radio Load Balancing |  (Mandatory) It is used to enable the load balancing function among radios. | |
| | inter-radio-balance num-balance enable | Enables inter-radio number –based balancing. |

| | | |
|---|--|--|
| |  (Optional) It is used to configure the load balancing parameters. | |
| | inter-radio-balance num-balance dual-band | Configures parameters for number-based balancing among inter-frequency radios. |
| | inter-radio-balance num-balance same-band | Configures parameters for number-based balancing among intra-frequency radios. |
| Configuring Association Control |  (Mandatory) It is used to enable the association control function. | |
| | package | Configures a package. |
| | primary-sta | Configures the primary STA in the package. |
| | secondary-sta | Configures the secondary STA in the package. |
| | control-zone | Configures an association control zone. |
| | ap | Configures the AP information. |
| | assoc-control | Enables association control. |

3.4.1 Configuring Inter-Radio Load Balancing

Configuration Effect

- Enable inter-radio load balancing on APs to balance the load among radios.

Notes

- This function is not applicable to the i-Share solution. Signals of different radios cover different areas. A STA may receive signals from one or several radios. In this case, the inter-radio load balancing function cannot be enabled.
- Load balancing is applicable only to STAs that are associated. Therefore, after STAs are deassociated, the traffic difference between APs or the STA quantity difference may exceed the threshold.
- If the radio that a STA attempts to associate with is different from the radio with the lowest load, load balancing is performed only when the AP reports that the STA is capable of dual-band operation. Otherwise, the 2.4 GHz STAs may fail to be associated with 2.4 GHz radios when no STA is associated with 5 GHz radio.
- Configuration of load balancing parameters varies according to the inter-frequency and intra-frequency radios. When an AP is associated, the AP type is identified. If the AP supports inter-frequency radios, the inter-frequency configuration takes effect; otherwise, the intra-frequency configuration takes effect.
- For a specific AP, so far as load balancing is enabled in any of the ap-config, ap-group, and ap-config all modes, load balancing is enabled on this AP. If the load balancing configurations in the three modes are different, the configurations take effect in the following sequence: ap-config > ap-group > ap-config all.

- When inter-radio load balancing is enabled, the association attempt of the same STA will be denied for at most twice within five minutes. If the STA is still associated with a radio with a heavy load for the third time, the association is allowed. Therefore, the effect of inter-radio load balancing is related to the actual STA behaviors.

Configuration Steps

▾ Enabling Inter-radio Number Balancing

- (Mandatory)The configuration is performed on the Fat AP. After the function is enabled, the number of STAs is balanced whenever possible among different radios of the same AP.
- This function can be enabled for a single AP, all APs in an AP group, or all APs (configured in ap-config all mode).

| | |
|------------------------------|--|
| Command | inter-radio-balance num-balance enable |
| Parameter Description | - |
| Defaults | Inter-radio number balancing is disabled. |
| Command Mode | AP configuration mode, AP group configuration mode |
| Usage Guide | N/A |

▾ Configuring Inter-radio Load Balancing Parameters

- (Optional) The configuration is performed on the Fat AP. Parameters can be adjusted based on actual requirements of network optimization.
- Run the **inter-radio-balance num-balance dual-band enable-load en-num threshold thrs-num** command to configure the trigger threshold and the load threshold for number balancing among inter-frequency radios. A smaller trigger threshold indicates that it is easier to enable load balancing. A smaller load threshold indicates that the load is better balanced.
- Run the **inter-radio-balance num-balance same-band enable-load en-num threshold thrs-num** command to configure the trigger threshold and the load threshold for number balancing among intra-frequency radios. A smaller trigger threshold indicates that it is easier to enable load balancing. A smaller load threshold indicates that the load is better balanced.

| | |
|------------------------------|---|
| Command | inter-radio-balance num-balance dual-band enable-load en-num threshold thrs-num |
| Parameter Description | <i>en-num</i> : Indicates the trigger threshold. The value ranges from 1 to 100. <i>thrs-num</i> : Indicates the load threshold. The value ranges from 1 to 100. |
| Defaults | By default, both the trigger threshold and the load threshold are 20 and 8 respectively. |
| Command | Global configuration mode |

| | |
|--------------------|-----|
| Mode | |
| Usage Guide | N/A |

| | |
|------------------------------|---|
| Command | inter-radio-balance num-balance same-band enable-load <i>en-num</i> threshold <i>thrs-num</i> |
| Parameter Description | <i>en-num</i> : Indicates the trigger threshold. The value ranges from 1 to 100. <i>thrs-num</i> : Indicates the load threshold. The value ranges from 1 to 100. |
| Defaults | By default, both the trigger threshold and the load threshold are 20 and 8 respectively. |
| Command Mode | Global configuration mode |
| Usage Guide | N/A |

↘ **Configuring Weight for Load Balancing Among Radio**

- (Optional) The configuration is performed on the Fat AP.

| | |
|------------------------------|---|
| Command | inter-radio-balance radio <i>radio-id</i> weight <i>weight-num</i> |
| Parameter Description | N/A |
| Defaults | The default weight is 100, that is, radio 1: radio 2=100:100 (1:1). |
| Command Mode | Global configuration mode |
| Usage Guide | N/A |

Verification

- Number balancing: Run the **show ap-config summary** command to check whether the difference in the number of STAs between radios of the AP where load balancing is within the threshold.

Configuration Example

N/A

Common Errors

N/A

3.4.2 Configuring Association Control

Configuration Effect

- Secondary STAs must be associated with APs in the same group as the primary STA when being associated.

Notes

- When a package is deleted, all its related configurations are deleted as well. If some STAs in this package are currently associated, all these STAs will be deassociated.
- A package can only be configured with one primary STA. If the information about the primary STA in the package is configured for multiple times, the latest configuration prevails.
- When a primary STA is deleted from a package, the primary STA and all secondary STAs in this package may be deassociated.
- When a secondary STA is deleted from a package, this secondary STA may be deassociated.
- The association control zone name cannot be duplicated; otherwise, an error will be prompted. In addition, if an association control zone is deleted, all configurations related to this zone will be deleted. Consequently, STAs in the package associated with this control zone may be deassociated.
- When the AP information in an association control zone is deleted, STAs in the package associated with this AP be deassociated.

Configuration Steps

▾ Configuring a Package

- (Mandatory) The configuration is performed on a fat AP.
- The primary and secondary STA information can be configured only after a package is configured.

| | |
|------------------------------|--|
| Command | package <i>pkg-name</i> |
| Parameter Description | <i>pkg-name</i> : Indicates the name of a package. The package name is a string of 1 to 32 characters. |
| Defaults | No package is configured by default. |
| Command Mode | Global configuration mode |
| Usage Guide | N/A |

▾ Configuring the Primary and Secondary STAs in a Package

- (Mandatory) The configuration is performed on a fat AP.
- Run the **primary-sta** command to configure the primary STA. Only one primary STA can be configured. The secondary STAs will be associated with APs in the same group as the primary STA.
- Run the **secondary-sta** command to configure a secondary STA. After the secondary STA is configured, the secondary STA will be associated with an AP in the same group as the primary STA.

| | |
|------------------------------|--|
| Command | primary-sta <i>mac-address</i> |
| Parameter Description | <i>mac-address</i> : Indicates the MAC address of the STA. |
| Defaults | No primary STA is configured by default. |
| Command Mode | Package configuration mode |
| Usage Guide | N/A |

| | |
|------------------------------|--|
| Command | secondary-sta <i>mac-address</i> |
| Parameter Description | <i>mac-address</i> : indicates the MAC address of the STA. |
| Defaults | No secondary STA is configured by default. |
| Command Mode | Package configuration mode |
| Usage Guide | - |

↘ Configuring an Association Control Zone

- (Mandatory) The configuration is performed on a fat AP.
- Configure an association control zone.
- APs can be added to an association control zone only after this association control zone is configured.

| | |
|------------------------------|--|
| Command | control-zone <i>czone-name</i> |
| Parameter Description | <i>czone-name</i> : Indicates the name of an association control zone. The name is a string of 1 to 64 characters. |
| Defaults | No association control zone is configured by default. |
| Command Mode | Global configuration mode |
| Usage Guide | N/A |

↘ Adding an AP to an Association Control Zone

- (Mandatory) The configuration is performed on a fat AP.
- Add an AP to an association control zone.
- Association control can be performed on only APs that are added to the association control zone.

| | |
|------------------------------|--|
| Command | ap <i>WORD</i> |
| Parameter Description | <i>WORD</i> : Indicates the name of an AP. The name is a string of 1 to 64 characters. |
| Defaults | No AP is added to an association control zone by default. |
| Command Mode | Association control zone configuration mode |

| | |
|--------------------|-----|
| Usage Guide | N/A |
|--------------------|-----|

➤ **Enabling the Association Control Function**

- (Mandatory) The configuration is performed on a fat AP. The **assoc-control** command must be used to enable the association control function.
- Enable the association control function.

| | |
|------------------------------|--|
| Command | assoc-control |
| Parameter Description | N/A |
| Defaults | The association control function is disabled by default. |
| Command Mode | Global configuration mode |
| Usage Guide | N/A |

Verification

- Verify that secondary STAs can be associated with APs in the same group as the primary STA.

Configuration Example

➤ **Configuring the E-bag in Fat AP Structure**

| | |
|--|---|
| <p>Scenario</p> <p>Figure 3-1</p> | |
| <p>Configuration Steps</p> | <ul style="list-style-type: none"> ● Configure packages and related primary STAs and secondary STAs. ● Configure association control zones and related APs. ● Enable the association control function. |
| <p>AP1</p> | <pre> AP1#configure terminal Enter configuration commands, one per line. End with CNTL/Z. AP1(config)# packageCart 1 AP1(config-package)#primary-sta 00d0.f800.0001 </pre> |

| | |
|----------------------------|---|
| | <pre> AP1(config-package)#secondary-sta 00d0.f800.0002 AP1(config-package)#secondary-sta 00d0.f800.0003 AP1(config-package)# exit AP1(config)# control-zone Classroom 1 AP1(config-czone)# apAP1 AP1(config-czone)# exit AP1(config)#assoc-control </pre> |
| <p>AP3</p> | <pre> AP3#configure terminal Enter configuration commands, one per line. End with CNTL/Z. AP3 (config)# package Cart 1 AP3(config-package)#primary-sta 00d0.f800.0001 AP3(config-package)#secondary-sta 00d0.f800.0002 AP3(config-package)#secondary-sta 00d0.f800.0003 AP3(config-package)# exit AP3(config)# control-zone Classroom 2 AP3(config-czone)# apAP3 AP3(config-czone)# exit AP3(config)#assoc-control </pre> |
| | |
| <p>Verification</p> | <ul style="list-style-type: none"> ● Display the association control running state. ● Display the package configuration. ● Display the association control zone configurations. |
| <p>AP1</p> | <pre> AP1#show assoc-control Association control is enabled. AP1# show package total package num : 1 ===== Cart 1 ===== primary STA : 00d0.f800.0001 secondary STA num : 2 00d0.f800.0002 00d0.f800.0003 AP1# show control-zone </pre> |

| | |
|-------------------|--|
| | <pre>control zone num : 1 control-zoneAP ----- Classroom 1 AP1 00d0.f800.889e</pre> |
| <p>AP3</p> | <pre>AP3#show assoc-control Association control is enabled. AP3# show package ===== Cart 1 ===== primary STA : 00d0.f800.0001 secondary STA num : 2 00d0.f800.0002 00d0.f800.0003 AP3# show assoc-control control zone num : 1 control-zoneAP ----- Classroom 1 AP3 00d0.f800.889f</pre> |

Common Errors

- N/A

3.5 Monitoring

Displaying

| Description | Command |
|--|--|
| Displays the status of the association control function. | show assoc-control |
| Displays the association control zone configuration. | show control-zone [summary <i>czone-name</i>] |
| Displays the package configuration. | show package [<i>pkt-name</i>] |

4 Configuring WBS

4.1 Overview

The Wireless Basic Service (WBS) is used to configure wireless-specific parameters on access controllers (ACs) when thin access points (APs) are deployed.

Link integrity detection is a basic service of the WBS. It detects the wired uplinks on APs. When the links are disconnected, the access services of the APs are stopped to force users offline. When the links are restored, the APs continue to provide wireless access services. Enabling link integrity detection in a thin AP architecture with dense AP deployment helps reduce the network disconnection time and improve user experience.

Protocols and Standards

- 802.11n: Enhancements for Higher Throughput

4.2 Applications

| Application | Description |
|---|---|
| Configuring Thin APs | Run commands on ACs to configure the parameters of thin APs. |
| Enabling Link Integrity Detection | Enable link integrity detection in a thin AP architecture to improve the quality of service (QoS) of wireless access. |

4.2.1 Configuring Thin APs

Scenario

Configure thin APs. Administrators can manage the configurations of thin APs on an AC in a centralized manner. Assume that a network has the following deployment requirements:

1. Allow the AC to monitor the status of the feeder links on i-Share APs.
2. Prevent stations (STAs) with received signal strength indication (RSSI) smaller than 20 from accessing the network.
3. Enable short guard interval (GI) in 20 MHz.
4. Prevent the use of low data rates, such as 1 Mbps, 2 Mbps, and 5.5 Mbps.

Figure 4-1 shows the thin AP networking topology.

Figure 4-1 Thin AP Networking Topology

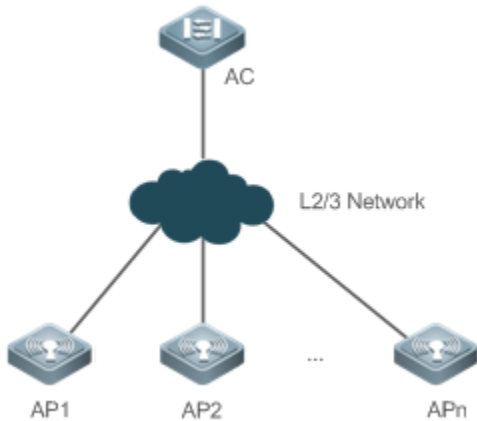

Deployment

Main configuration points on the AC:

1. Enable i-Share antenna feeder link detection for all the APs and set the detection interval to an expected value.
2. Run **response-rssi** for the radios of all the APs and set the threshold to 20 dB.
3. Run **short-gi enable** for the radios of all the APs and set the bandwidth to 20 MHz.
4. Disable the use of the 1 Mbps, 2 Mbps, and 5.5 Mbps data rates for 802.11b/g network users.

4.2.2 Enabling Link Integrity Detection

Scenario

Enable link integrity detection on wireless networks with a thin AP architecture.

See Figure 4-2.

- An AC is connected to the Internet through a router. AP1, AP2, and AP3 are connected to the router through three switches and associated with the AC.
- Station 1 (STA1) is associated with AP1, STA2 and STA3 are associated with AP2, and STA4 is associated with AP3. The STAs access the Internet through the AC.

Figure 4-2

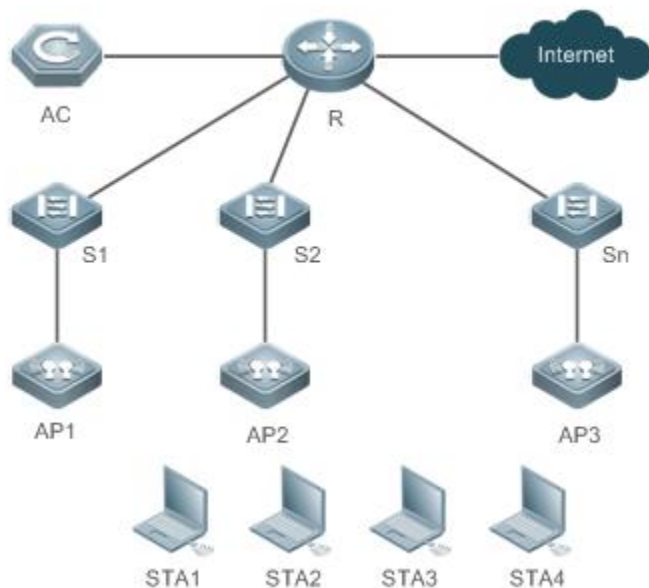

| | |
|----------------|---|
| Remarks | <p>R is an egress router.</p> <p>S1, S2, and S3 are Layer-2 switches and function as the access devices for APs.</p> <p>AP1, AP2, and AP3 are directly connected to S1, S2, and S3.</p> |
|----------------|---|

Deployment

- Layer-2 switches provide the access service to APs.
- Router R sets up connections between ACs and APs and between STAs and the Internet.

4.3 Features

4.3.1 Enabling Link Integrity Detection

APs are wireless access devices without the switching feature. They implement all functions of the physical layer and partial functions of the MAC layer. A fat AP or thin AP has only one wired uplink, which is the data channel allowing STAs to access the AP. When the wired uplink is disconnected because of a fault, all the wireless STAs connected to the AP cannot access the Internet.

Wireless STAs cannot sense link disconnections immediately or take measures; as a result, the network connection cannot be restored for a long time.

Link integrity detection is designed to solve this problem.

Working Principle

The link integrity detection function continuously detects the status of the wired uplinks on APs. When a wired uplink is disconnected, the RF interface of the AP is disabled to stop the access service. The wireless STAs associated with the AP are forced offline and have to reconnect to other normal APs.

When the wired uplink is recovered, the link integrity detection function enables the RF interface of the AP again to restore the wireless access service.

Link integrity detection enables the wireless STAs that are associated with APs with disconnected wired uplinks to reconnect to other normal APs.

4.3.2 Configuring Forced Power Supply

Configure the forced power supply mode for the AP.

Working Principle

The forced power supply modes include `af/at25w/36w/bt`.

 The `save` parameter is used to save the configuration.



4.3.3 Configuring Radio

Some APs can be specified with radio (802.11a/802.11b) at startup.

Working Principle

Some APs can be specified with radio (802.11a/802.11b) at startup. When APs are running, radio switchover is not allowed.

4.4 Configuration

| Configuration | Description and Command | |
|---|--|--|
| Configuring AP RF Parameters | <code>fragment-burst</code> | Configures frame bursting for specified AP radios. |
| | <code>11ax-gi</code> | Configures 11ax-gi for specified AP radios. |
| Enabling Link Integrity Detection |  (Mandatory) It is used to enable link integrity detection. | |
| | <code>link-check enable</code> | Enables link integrity detection. |
| Configuring Forced Power Supply | <code>pdpoe-force { af at25w at36w bt } [save]</code> | Configures forced power supply. |
| Configuring Radio |  Optional | |
| | <code>ap-band-mode</code> | Configures the radio. |

4.4.1 Configuring AP RF Parameters

Configuration Effect

- Configure the RF parameters for APs and radios for easier configuration management.

Configuration Steps

▾ Configuring Frame Bursting Mechanism

- Optional.
- The AC delivers the settings to the APs to enable or disable frame bursting.

| | |
|----------------------------------|--|
| Command | fragment-burst { enable disable dynamic } radio radio-id |
| Parameter Description | <p><i>enable</i>: Enables frame bursting mechanism.</p> <p><i>disable</i>: Disables frame bursting mechanism.</p> <p><i>dynamic</i>: Dynamic frame bursting mechanism.</p> <p><i>radio-id</i>: Specifies the IDs of the radios. The value ranges from 1 to 96.</p> |
| Defaults | Frame bursting is disabled by default. |
| Command Mode | AP configuration mode |
| Configuration Usage Guide | N/A |

▾ Configuring 11ax-gi

- Optional.
- The AC delivers the settings to the APs to instruct the AP radio to apply specified 11ax-gi settings.

| | |
|----------------------------------|---|
| Command | 11ax-gi { 0.8 1.6 3.2 auto } radio radio-id |
| Parameter Description | <p><i>radio-id</i>: Specifies the radio ID, in the range from 1 to 96.</p> <p>0.8: Sets gi to 0.8us.</p> <p>1.6: Sets gi to 1.6us.</p> <p>3.2: Sets gi to 3.2us.</p> <p>auto: Sets gi to auto mode.</p> |
| Defaults | Auto mode |
| Command Mode | AP configuration mode |
| Configuration Usage Guide | N/A |

4.4.2 Enabling Link Integrity Detection

Configuration Effect

- Enable link integrity detection.

Configuration Steps

▾ Enabling Link Integrity Detection

- (Mandatory) Run **link-check enable** to enable link integrity detection.

| | |
|----------------------------------|---|
| Command | link-check enable |
| Parameter | N/A |
| Description | |
| Defaults | By default, link integrity detection is disabled. |
| Command Mode | Global configuration mode |
| Configuration Usage Guide | By default, link integrity detection is disabled. |

Verification

- Run **show running-config** to display the configuration status of link integrity detection.

Configuration Example

▾ Enabling Link Integrity Detection

Scenario
Figure 4-3

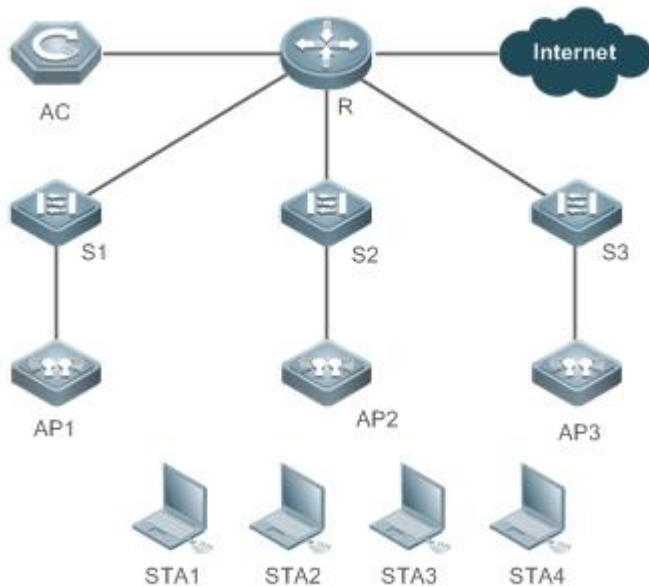

In Figure 4-3, an AC is connected to thin APs. Enable link integrity detection according to the following step:
1. Enable link integrity detection.

Configuration Steps

- Enable link integrity detection on the AC.

```
Ruijie# configure terminal
Ruijie(config)# link-check enable
```

Verification

- Run **show running-config** to display the configuration status of link integrity detection.

```
Ruijie(config)# show running-config
.....
link-check enable
.....
```

4.4.3 Enabling/Disabling an AP to Supply Power to External Devices via the Ethernet Cable

Configuration Effect

- Enable or disable an AP to supply power to external devices via the Ethernet cable.

Notes

- Only some models of fat APs support this function.

Configuration Steps

Enabling/Disabling an AP to Supply Power to External Devices via the Ethernet Cable

- Optional.
- Run this command to enable/disable an AP to supply power to external devices via the Ethernet cable in global configuration mode.

| | |
|------------------------------|---|
| Command | <code>poeout { enable disable default }</code> |
| Parameter Description | <p>enable: Enables an AP to supply power to external devices via the Ethernet cable.</p> <p>disable: Disables an AP to supply power to external devices via the Ethernet cable.</p> <p>default: Use the default settings for an AP to supply power to external devices via the Ethernet cable.</p> |
| Defaults | The default settings are used for an AP to supply power to external devices via the Ethernet cable. |
| Command Mode | Global configuration mode |
| Usage Guide | This command is automatically saved after being configured, without a need to use the write command for saving. This command does not support the no poeout and default poeout forms. |

Verification

- Run the **show poeout** command to display the configurations.

Configuration Example

Enabling an AP to Supply Power to External Devices via the Ethernet Cable

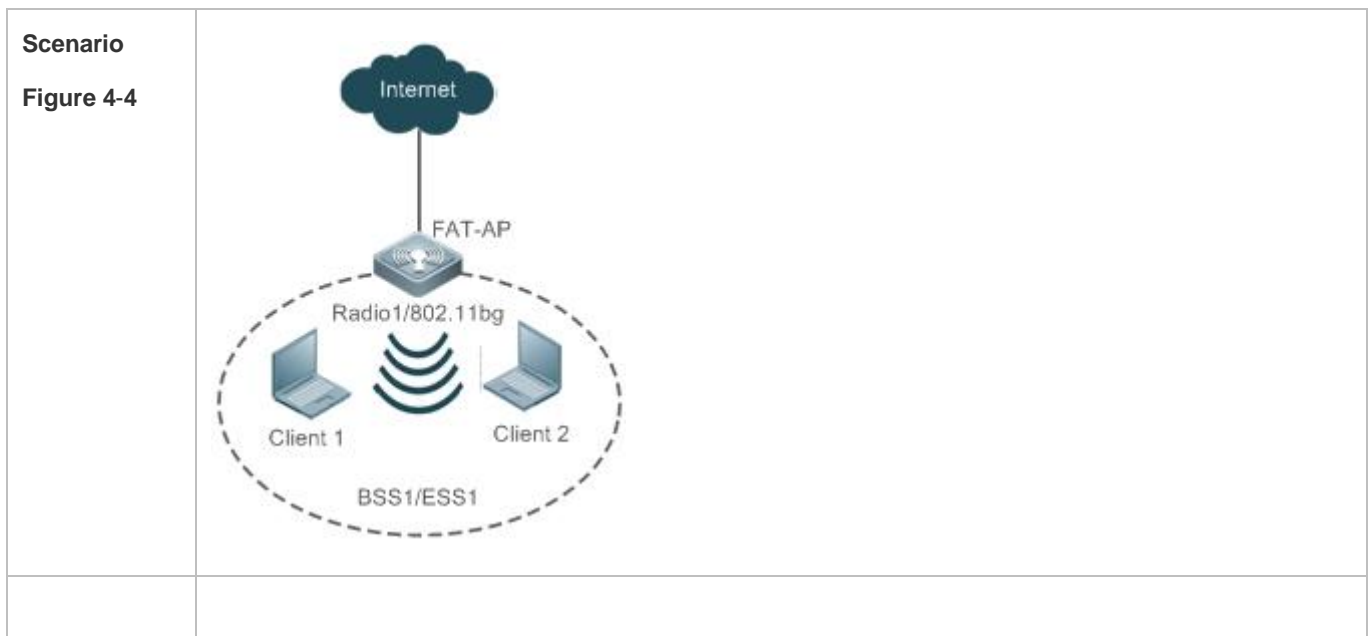

| | |
|----------------------------|--|
| Configuration Steps | <ul style="list-style-type: none"> Enable an AP to supply power to external devices via the Ethernet cable. |
| FAT-AP | <pre>Ruijie#config Ruijie(config)#poeout enable</pre> |
| Verification | <ul style="list-style-type: none"> Run the show poeout command to display the configured command. |
| | <pre>Ruijie#show poeout poeout enable Ruijie#</pre> |

4.4.4 Configuring Forced Power Supply

Configuration Effect

- Configure the forced power supply mode including AF, AT25W, AT36W, and BT and save the configuration.

Notes

- This function is supported by fat APs.

Configuration Steps

⌵ Configuring pdpoe-force

- Optional.
- When some APs powered over PoE+ are connected to some devices incapable of PoE+ negotiation, the power limit will be canceled.

Command `pdpoe-force { af | at25w | at36w | bt } [save]`

Parameter Description

af: Sets the forced power supply mode to AP, consumption: 13.0W.
at25w: Sets the forced power supply mode to AT, consumption: 25.5W.
at36w: Sets the forced power supply mode to AT36, consumption: 36.0W.
bt: Sets the forced power supply mode to BT, consumption: 62.0W.
save: Saves the configuration.

Defaults N/A

Command Mode Global configuration mode

Usage Guide N/A

Verification

Run the **show running-config** command to display the configuration.

! Please make sure that PoE device supports the max power consumption requirement. Otherwise, the AP may be restarted.

Configuration Example

Configuring pdpoe-force

Scenario

Figure 4-5

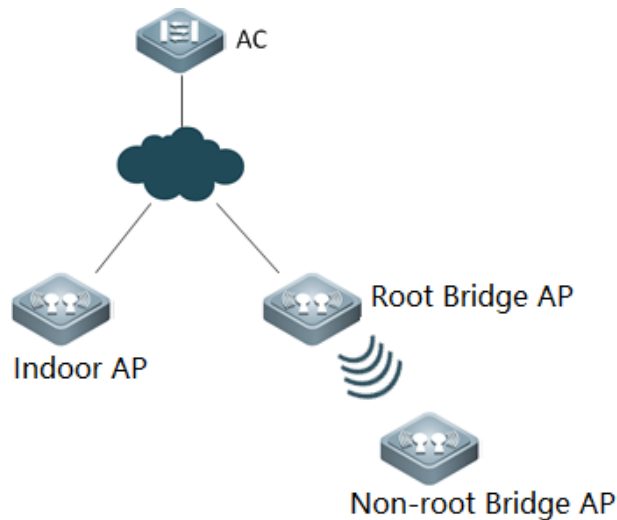

Configuration

Steps

If you want to set the forced power supply mode to bt:

Method 1. Configure this command on the AC:

```
Ruijie(config-ap)#exec-cmd mode config cmd "pdpoe-force bt save"
```

Method 2. Log in to AP via Telnet or serial port and run the following command:

```
Ruijie#configure
```

```
Ruijie(config)#pdpoe-force bt save
```

Verification

- Run the **show running-config** command to display radio of a specific AP.

```
Ruijie#show running-config
```

Scenario
Figure 4-5

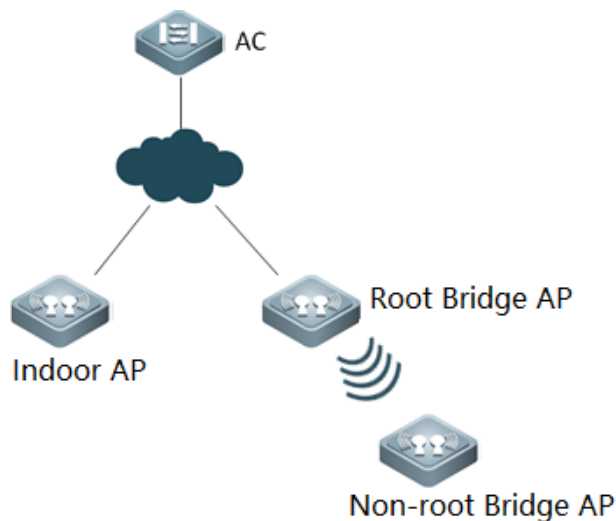

Configuration
Steps

If you want to set the forced power supply mode to bt:

Method 1. Configure this command on the AC:

```
Ruijie(config-ap)#exec-cmd mode config cmd "pdpo-force bt save"
```

Method 2. Log in to AP via Telnet or serial port and run the following command:

```
Ruijie#configure
```

```
Ruijie(config)#pdpo-force bt save
```

Verification

- Run the **show running-config** command to display radio of a specific AP.

```
link-check disable
!
pdpo-force bt save
!
Nfpp
Ruijie#
```

4.4.5 Configuring Radio

Configuration Effect

- Run this command to configure radio (802.11a/802.11b) of The AP at startup.

Notes

- Only AP680 supports this configuration currently.

Configuration Steps

- Optional
- After this command is configured, the AC delivers the configuration to an AP to notify the AP of the radio and restart the AP.

Command `ap-band-mode { 802.11a | 802.11b } radio [radio-id]`

Parameter `802.11a`: Specifies the 5GHz radio.

Description `802.11b`: Specifies the 2GHz radio.

`radio-id`: Configures the radio ID, in the range from 1 to 96.

Defaults -

Command AP configuration mode

Mode

Usage Guide

1. This command is run at startup and cannot be saved.
2. Running this command will restart the AP automatically.

Verification

- Run the `show ap-config summary` command to display radio of the AP.

Configuration Example

Configuring Radio

Scenario

Figure 4-6

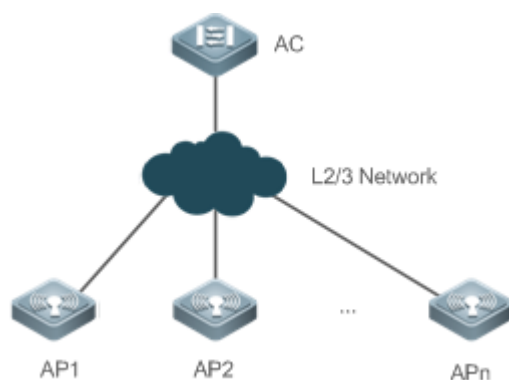

- Configuration Steps**
- The following example sets Radio3 of AP680 to 802.11a:

```
Ruijie# configure terminal
Ruijie(config)# ap-config ap680
Ruijie(config-ap)# ap-band-mode 802.11a radio 3
Switch the band model will auto reload system, continue?(Y/N) Y
```

- Verification**
- Run the **show ap-config summary** command to display radio of a specific AP.

```
Ruijie#show ap-config summary
===== show ap status =====
Radio: Radio ID or Band: 2.4G = 1#, 5G = 2#
      E = enabled, D = disabled, N = Not exist, V = Virtual AP
      Current Sta number
      Channel: * = Global
      Power Level = Percent

Online AP number: 2
Offline AP number: 29

AP Name                               IP Address      Mac Address     Radio
Radio           Up/Off time  State
-----
ap680                               172.30.103.216  f822.5896.5858 1 E 0 6 100 2 E
0 153 100 0:00:00:32 Run
                                     3 E 0 40 100 4
N - - -
```

Monitoring

Displaying

| Description | Command |
|---|---|
| Displays the link information of wireless STAs. | linktest |
| Displays the AP list that maps the 802.11a or 802.11b network on an AC. | show ac-config { 802.11a 802.11b } summary |
| Displays the antenna feeder status of all APs. | show antenna all |

| Description | Command |
|---|--|
| Displays the antenna feeder status of an AP. | show antenna single <i>ap-name</i> |
| Displays the radio information of all APs. | show ap-config radio |
| Displays the radio information of an AP. | show ap-config radio ap-name <i>ap-name</i> |
| Display featured configuration about radio of an AP. | show ap-config radio info <i>ap-name</i> |
| Displays the configuration information of an AP radio. | show ap-config radio <i>radio-id</i> config <i>ap-name</i> |
| Displays the status information of an AP radio. | show ap-config radio <i>radio-id</i> status <i>ap-name</i> |
| Displays the radio list of an AP. | show ap-config radio status <i>ap-name</i> |
| Displays the radio information of all APs. | show ap-config summary radio |
| Displays the STA information mapped to a MAC address. | show client details <i>sta-mac</i> |
| Displays the hop channel and bandwidth of a specified AP or all APs. | show dfs adjustment-channels [<i>ap-name</i>] |
| Displays idle channels of a specified AP or all APs. | show dfs non-occupancy-channels [<i>ap-name</i>] |
| Displays historical records of radar channels of a specified AP or all APs. | show dfs historical-radar-channels [<i>ap-name</i>] |
| Clear historical records of radar channels of a specified AP or all APs. | clear dfs historical-radar-channels [<i>ap-name</i>] |

5 Configuring DATA-PLANE

5.1 Overview

The data plane provides broadcast forwarding control functions, including broadcast forwarding weight control and broadcast wireless forwarding control.

Broadcast forwarding weight control means restricting the weights of packet types for broadcast forwarding, so as to prevent STAs from being influenced when a certain type of packets occupy all resources.

Broadcast wireless forwarding control means forwarding only necessary packets to the wireless network, so as to prevent some useless broadcast packets from occupying substantial radio frequency (RF) resources.

- Broadcast forwarding weight control is applicable to all packets to be flooded.
- Broadcast wireless forwarding control is applicable to all packets to be sent to the radio interface.

Protocols and Standards

- N/A

5.2 Applications

- N/A

5.3 Features

Basic Concepts

↘ Broadcast Forwarding Weight Control

A network switching device may need to flood broadcast packets, multicast packets, and some unicast packets. A weight can be set for each type of packets to prevent a certain type of broadcast packets from exhausting all broadcast forwarding capabilities, thereby improving STAs' network experience.

↘ Broadcast Wireless Forwarding Control

The broadcast wireless forwarding control function is used to forward only necessary broadcast packets to the wireless network, so as to prevent certain broadcast packets from occupying substantial air interface resources and improve the network rates of STAs.

Overview

| Feature | Description |
|---|--|
| Broadcast Forwarding Weight Control | Restricts the weights of packet types for broadcast forwarding, so as to protect RF resources from being occupied by a certain type of packets and thereby guarantee normal forwarding of other packets. |
| Broadcast Wireless Forwarding Control | Controls whether to forward broadcast packets to the wireless network, so as to prevent useless broadcast packets from occupying substantial RF resources. |

5.3.1 Broadcast Forwarding Weight Control

Broadcast forwarding weight control is used to restrict a certain type of packets, so that the ratio of this type of packets is no greater than the specified weight during broadcast forwarding.

Working Principle

The broadcast forwarding weight control function classifies packets at first into unicast packets, multicast packets, broadcast packets, unknown multicast packets, and unknown unicast packets.

- Classify packets. Packets may be roughly classified into the following types: unicast packets, multicast packets, broadcast packets, unknown multicast packets, and unknown unicast packets.
- Allocate a token bucket to each type of packets, and record the number of packets permitted to pass at this moment.
- According to the configured broadcast forwarding weights, calculate the number of packets permitted to pass within each interval, and adjust the sizes of the token buckets accordingly.
- When a packet arrives, determine the type of the packet and check whether there is any token in the token bucket corresponding to the packet type. If the token bucket contains a token, the packet is permitted to pass; otherwise, the packet is discarded.

5.3.2 Broadcast Wireless Forwarding Control

The broadcast wireless forwarding control function is used to forward only partial packets that affect STAs to the wireless network, so as to prevent useless broadcast packets from occupying substantial air interface resources.



Working Principle

Wireless networks differ from wired networks in performance. In a wireless network, air interface resources are shared by STAs and APs which often becomes a bottleneck for STAs. Meanwhile, they are seized for a long time because broadcast packets are sent at low rates.

In practice, some broadcast packets are useless for STAs. Forwarding these packets to the wireless network will result in fewer air interface resources and worse user experience.

One solution is to classify broadcast packets for forwarding control. Only the packets of specified types are forwarded to the wireless network.

5.4 Configuration

| Configuration | Description and Command | |
|---|---|--|
| Broadcast Forwarding Weight Control |  Optional configuration. Set the weights of packet types for broadcast forwarding. | |
| | data-plane queue-weight | Configures the weights of packet types for broadcast forwarding on the AP. |
| | data-plane token | Configures the refresh interval of the broadcast token bucket and bucket-based rate on the AP. |
| Broadcast Wireless Forwarding Control |  Optional configuration. Enable the broadcast wireless forwarding function. | |
| | data-plane wireless-broadcast | Enables or disables the broadcast wireless forwarding control function on the AP. |

5.4.1 Configuring Broadcast Forwarding Weights

Networking Requirements

- You can control the weight of a packet type for forwarding according to actual network conditions, so as to avoid network congestion for sudden traffic spike.

Notes

- N/A

Configuration Steps

▾ Configuring Broadcast Forwarding Weights

- Optional configuration. Run the **data-plane queue-weight** command to configure the broadcast forwarding weights.

| | |
|------------------------------|---|
| Command | data-plane queue-weight <i>unicast-packet-weight multicast-packet-weight broadcast-packet-weight unknown-multicast-packet-weight unknown-unicast-packet-weight</i> |
| Parameter Description | <p><i>unicast-packet-weight</i>: sets the forwarding weight of unicast packets. The range is from 1 to 100. The default weight is 16.</p> <p><i>multicast-packet-weight</i>: sets the forwarding weight of multicast packets. The range is from 1 to 50. The default weight is 4.</p> <p><i>broadcast-packet-weight</i>: sets the forwarding weight of broadcast packets. The range is from 1 to 50. The default weight is 2.</p> <p><i>unknown-multicast-packet-weight</i>: sets the forwarding weight of unknown multicast packets. The range is from 1 to 25. The default weight is 1.</p> <p><i>unknown-unicast-packet-weight</i>: sets the forwarding weight of unknown unicast packets. The range is from 1 to 25. The default weight is 1.</p> |
| Defaults | Default weights are applied. |
| Command Mode | Global configuration mode |
| Configuration Usage | N/A |

📌 Configuring Refresh Interval of Broadcast Token Bucket and Bucket-based Rate

- Optional configuration. Run the **show run** command to display the configuration.

| | |
|------------------------------|--|
| Command | data-plane token <i>token-interval token-base-rate</i> |
| Parameter Description | <p><i>token-interval</i>: Refresh interval of broadcast token bucket in 10ms. The default interval is 1.</p> <p><i>token-base-rate</i>: Token bucket-based rate. The default rate is 5 for the AP.</p> |
| Defaults | Default parameters are applied. |
| Command Mode | Global configuration mode |
| Configuration Usage | Broadcast rate per second = Packet weight × (1s/Refresh Interval) × Token bucket-based rate |

Verification

- Run the show run command to display configuration information.

Configuration Example

N/A

5.4.2 Configuring Broadcast Wireless Forwarding

Networking Requirements

- Useless broadcast packets are not forwarded to the air interface.

Notes

- N/A

Configuration Steps

↘ Broadcast Forwarding Function

- Optional configuration. By default, the broadcast wireless forwarding function is disabled. Run the data-plane wireless-broadcast command in global configuration mode to enable or disable this function.

| | |
|----------------------------|---|
| Command | <code>data-plane wireless-broadcast{ enable disable }</code> |
| Parameter | enable: permits all broadcast packets to be forwarded to the air interface |
| Description | disable: prohibits all broadcast packets from being forwarded to the air interface |
| Defaults | The broadcast wireless forwarding function is disabled; that is, broadcast packets are not forwarded to the wireless network. |
| Command Mode | Global configuration mode |
| Configuration Usage | N/A |

↘ Verification

- Run the show run command to display configuration information.

Configuration Example

N/A

Common Errors

N/A

5.5 Monitoring

- N/A

6 Configuring WLOG

6.1 Overview

WLOG (WLAN Log) enables storing and viewing wireless network and STA status in a past period of time. By collecting and storing the information of wireless network, AP and STA in the past 24 hours and then displaying the information through CLI commands, WLOG allows users to analyze the wireless network status and troubleshoot problems.

WLOG is for collecting and storage information, but does not support automatic information analysis temporarily. The WLOG feature is dedicated to enabling users, with provided information, to have a more accurate understanding of the wireless network and STA status in the past 24 hours to analyze and troubleshoot problems.

Protocols and Standards

- N/A

6.2 Applications

- N/A

6.3 Features

Basic Concepts

📄 The general information on the AP includes:

- AP name
- AP MAC address
- AP IP address
- AP uptime
- Status of each wired port of the AP
 1. Input/output rate (bits/sec) in last 5 minutes
 2. Statistics of input/output of unicast, broadcast, multicast and error frames
- General information on each radio
 1. Working channel
 2. Transmit power (dBm, absolute value)
 3. Number of associated online STAs

4. Number of online STAs which have passed Web authentication
5. Number of online STAs which have passed 802.1x authentication
6. Intensity of the co-channel interference signal
7. Number of received error frames
8. Packet retransmission times

▾ The general information on the STA includes:

1. IP address
2. Signal strength
3. Access rate
4. Associated AP, radio and SSID

▾ STA's spatial information

- The STA's spatial information mainly includes the statistics of data frame and management frame of the STA, as well as the statistics of each type of rate, as detailed below:

1. Number of data frames successfully transmitted (from the AP to the STA)/total traffic
2. Number of unresponsive data frames/total traffic
3. Number of management frames/total traffic
4. Statistics of each type of frames with access rate (The access rate is divided into 8 grades for statistics)

| Grade | 0 | 1 | 2 | 3 | 4 | 5 | 6 | 7 |
|--------------------|-----|--------|-----|-------|-------|-------|----------|----------|
| Access Type (Mbps) | 1/2 | 5.5/11 | 6/9 | 12/18 | 24/36 | 48/54 | Reserved | Reserved |

5. Statistics of each type of frame with MIMO rate (The MIMO rate is divided into 8 grades for statistics)

| Grade | 0 | 1 | 2 | 3 | 4 | 5 | 6 | 7 |
|-----------|------|------|------|------|------|-------|-------|-------|
| MIMO Type | mcs0 | mcs2 | mcs4 | mcs6 | mcs8 | mcs10 | mcs12 | mcs14 |
| | mcs1 | mcs3 | mcs5 | mcs7 | mcs9 | mcs11 | mcs13 | mcs15 |

The spatial information is mainly used to check whether the STA is in low-speed state, whether the proportion of the case in which no ACK frame is transmitted is too high, and whether too many management frames are transmitted and received, so as to further analyze and locate the network problems caused by low speed node, management frame attack, and poor condition. The STA's spatial information varies in real time, and the current collection frequency is once every five minutes. The information is saved only on the AP due to large data volume.

▾ AP Behavior Type

The AP behavior type includes going online, going offline and CAPWAP connection failure.

Features

| Feature | Description |
|---------|-------------|
|---------|-------------|

| | |
|---|--|
| Enabling the WLOG Feature | You can enable the WLOG feature to automatically collect AP and STA information. |
|---|--|

6.3.1 Enabling the WLOG Feature

After the WLOG feature is enabled, the AP automatically collects AP and STA information and records the information into memory, enabling users, with provided information, to have a more accurate understanding of the wireless network and STA status in the past 24 hours and analyze and troubleshoot problems.

Working Principle

After the WLOG feature is enabled, the AP automatically collects AP and STA information and records the information into memory, and receives online/offline advertisement of the AP and STA and records into memory for users to view.

6.4 Configuration

| Configuration | Description and Command | |
|---|--|--------------------------|
| Enabling the WLOG Feature |  (Mandatory) It is used to enable the WLOG feature. | |
| | wlan diag enable | Enables the WLOG feature |

6.4.1 Enabling the WLOG Feature

Configuration Effect

- After the WLOG feature is enabled, the AP automatically records the AP and STA information.

Notes

- Enabling the WLOG feature pre-allocates memory. If the memory is not sufficient, the WLOG feature cannot be enabled. Disabling the WLOG feature frees all memory for information storage and pre-allocated memory.

Configuration Steps

▾ Enabling the WLOG Feature

- (Mandatory) Run the **wlog diag enable** command to enable the WLOG feature.
- Enable the WLOG feature in global configuration mode of the AP device.
- After the WLOG feature is enabled, information is collected and recorded into memory on a regular basis.

| | |
|---------------------|--|
| Command | wlan diag enable |
| Parameter | - |
| Description | |
| Defaults | By default, the WLOG feature is disabled on the AP device. |
| Command Mode | Global configuration mode |

| | |
|--------------------|-----|
| Usage Guide | N/A |
|--------------------|-----|

Verification

- Run the **show wlan diag sta** command to check whether the STA information can be viewed on the AP.

Configuration Example

- N/A

Common Errors

- N/A

6.5 Monitoring

Displaying

| Description | Command |
|--|---|
| Displays the STA information on the AP | show wlan diag sta [<i>sta-mac sta-mac</i>] [number number] |



WLAN RF Configuration

- 1 Configuring RF Scheduling
- 2 Configuring Band Select

1 Configuring RF Scheduling

1.1 Overview

i The radio frequency (RF) resources mentioned in this document include the RF of an Access Point (AP) as well as a wireless local area network (WLAN) services.

RF scheduling can perform automatic management on the RF resources.

RF scheduling can be used to disable the RF of an AP or a WLAN in the specified time interval, realizing the following functions:

- Reducing network traffic, saving network resources, and preventing waste or abuse of network resources
- Reducing RF interference and saving energy
- Disabling access services in a certain period to reduce potential security risks

RF scheduling can be used in the scenarios where wireless access services are required in specific time cycles.

1.2 Applications

N/A

1.3 Features

Basic Concepts

📌 Scheduling Session

A scheduling session indicates a time interval for an RF resource. A simple scheduling session contains only one time interval in a certain day; a complex scheduling session contains many duplicate time intervals in different dates. Currently, one scheduling session supports eight different (or same) time intervals.

For example, you can specify scheduling sessions as follows: 12:00–14:00 and 18:00–8:00 from Monday to Friday; 8:00–12:00 and 17:00–8:00 from Saturday to Sunday.

Overview

| Feature | Description |
|--|--|
| Configuring a Scheduling Session | Specifies a scheduling session. |
| Scheduling WLAN | Applies a scheduling session to a WLAN to enable or disable the WLAN periodically. |

1.3.1 Configuring a Scheduling Session

Specify a scheduling session.

Working Principle

Before using the scheduling function, a scheduling session needs to be created first to specify the time for RF scheduling. Then the scheduling session can be applied to an AP RF interface or WLAN.

▾ **Configuring a Scheduling Session**

First, you need to create a scheduling session and specify the time and cycle.

For example, in the preceding example, if you want to provide wireless access services only in the daytime to teaching building, you can first create a scheduling session to specify the cycle as every day, and the scheduling interval as a period at night, for example, 21:00 to 6:00. If you want to provide WLAN services to customers of a bank only in the business hours of workdays, you can create a scheduling session to specify the cycle as workdays, and the scheduling time interval as off hours, for example, 18:00 to 9:00; and you can create the other cycle as weekends, and the scheduling interval as all day.

1.3.2 Scheduling AP RF

Enable or disable AP RF periodically.

Working Principle

Before using the scheduling function, a scheduling session needs to be created first to specify the time for RF scheduling. Then you can apply the scheduling session to an AP RF interface.

When the scheduling session starts or ends, the system sends a scheduling message. The processing logic of the scheduling message will enable or disable the RF interface of an AP or the RF interfaces of an AP group where this scheduling session is applied.

▾ **Applying a Scheduling Session on an RF Interface**

After a scheduling session is created, it must be applied to the corresponding AP RF interface so that the scheduling can take effect.

▾ **Handling of a Scheduling Message**

After a scheduling session is created and the cycle and interval are specified, the system will start the timer of the scheduling session, and send a message after entering or exiting from this scheduling session. A scheduling message includes the following information:

- Scheduling Session ID
- Message type: the scheduling state, including entering and exiting from the scheduling session

1.3.3 Scheduling WLAN

Enable or disable a WLAN periodically.

Working Principle

Before using the scheduling function, a scheduling session needs to be created first to specify the time for WLAN scheduling. Then the scheduling session can be applied to a WLAN.

When the scheduling session starts or ends, the system sends a scheduling message. In the handling of the scheduling message, the processing logic will locate the WLAN where this scheduling session is applied to, and enable or disable the WLAN.

➤ **Applying a Scheduling Session on an RF Interface**

After the scheduling session is created, it must be applied to the corresponding WLAN so that the scheduling can take effect.

You need to specify in WLAN configuration mode the scheduling Session ID for the WLAN.



➤ **Handling of a Scheduling Message**

After a scheduling session is created and the cycle and interval are specified, the system will start the timer of the scheduling session, and send a message after entering or exiting from this scheduling session. A scheduling message includes the following information:

- Scheduling Session ID
- Message type: entering or exiting from the scheduling session

The handling of a scheduling message covers all WLANs. The system will first check the session to which the WLAN is applied. If the scheduling Session ID to which the WLAN is applied is the same as that in the message, the message type will be checked. If in the scheduling state, the WLAN will be disabled. Otherwise, the radio will be enabled.

1.4 Configuration

| Configuration | Description and Command | |
|--|--|---|
| Configuring AP RF Scheduling |  (Mandatory) It is used to create a scheduling session, specify the time interval, and apply the scheduling session to an AP or AP group. | |
| | schedule session | Creates a scheduling session. |
| | schedule session time-range | Specifies the time interval of a scheduling session. |
| | schedule session | Applies the scheduling session to an AP or an AP group. |
| Configuring WLAN Scheduling |  (Mandatory) It is used to create a scheduling session and apply it to a WLAN. | |
| | schedule session | Creates a scheduling session. |
| | schedule session time-range | Specifies the time interval of a scheduling session. |
| | schedule session | Applies the scheduling session to a WLAN. |

1.4.1 Configuring AP RF Scheduling

Configuration Effect

- Create a scheduling session, specify a scheduling interval, and applies this scheduling session to an AP or an AP group to realize AP RF scheduling.

Configuration Steps

➤ **Creating a Scheduling Session**

- (Mandatory) In global configuration mode, run the **schedule session sid** command to create a scheduling session. *sid* indicates Session ID, which can be set to a value ranging from 1 to 8 on a fat AP.
- A scheduling session must first be created before use.

| | |
|------------------------------|--|
| Command | schedule session sid |
| Parameter Description | <i>sid</i> : Indicates Session ID. It can be set to a value ranging from 1 to 8 on a fat AP. |
| Defaults | By default, no scheduling session is created. |
| Command Mode | Global configuration mode |
| Usage Guide | N/A |

▾ **Specifying the Time Interval for a Scheduling Session**

- (Mandatory) Run **schedule session sid time-range n period day1 [to day2] time hh1:mm1 to hh2:mm2** to specify the time interval and cycle of a scheduling session.
- **session sid**: Indicates Session ID. It can be set to a value ranging from 1 to 8 on a fat AP.
- **time-range n**: Indicates the number of a time interval, which ranges from 1 to 8.
- **period day1 [to day2]**: Indicates the scheduling cycle, where *day1* indicates the start date, and *day2* indicates the end date, which can be set to { sun | mon | tue | wed | thu | fri | sat }.
- **to day2**: By default, this parameter indicates that the scheduling cycle is one day.
- **time hh1:mm1 to hh2:mm2**: Indicates the scheduling time period, and *hh1:mm1* and *hh2:mm2* indicate the start time and end time respectively in the unit of hours (ranging from 0 to 23) and minutes (ranging from 0 to 59).

| | |
|------------------------------|--|
| Command | schedule session sid time-range n period day1 [to day2] time hh1:mm1 to hh2:mm2 |
| Parameter Description | <i>sid</i> : Indicates Session ID. It can be set to a value ranging from 1 to 8 on a fat AP. <i>n</i> : Indicates the number of a time interval, which ranges from 1 to 8. <i>day1</i> : Indicates the start date of the scheduling session cycle, which can be set to { sun mon tue wed thu fri sat }. to day2 : <i>day2</i> indicates the end date of the scheduling session cycle. By default, this parameter indicates that the scheduling cycle is one day. time hh1:mm1 to hh2:mm2 : Indicates the scheduling time period, and <i>hh1:mm1</i> and <i>hh2:mm2</i> indicate the start time and end time respectively in the unit of hours (ranging from 0 to 23) and minutes (ranging from 0 to 59). |
| Defaults | No time period or cycle is configured by default. |
| Command Mode | Global configuration mode |
| Usage Guide | N/A |

▾ **Applying a Scheduling Session**

- Mandatory.
- In AP configuration mode, run the **schedule session sid** command to specify the Session ID for APs or a single AP

| | |
|------------------|--|
| Command | schedule session sid |
| Parameter | <i>sid</i> : Indicates Session ID. It can be set to a value ranging from 1 to 8 on a fat AP. |

| | |
|---------------------|---|
| Description | |
| Defaults | No scheduling session is applied on a single AP, an AP group, or all APs. |
| Command Mode | WLAN configuration mode or Interface configuration mode |
| Usage Guide | N/A |

Verification

- Run **show running-config** to display configurations on RF scheduling.
- Check whether scheduling is still performed for AP RF after a scheduling session expires.

Configuration

Example

N/A

Common Errors

- No scheduling session is created.
- The interval of the scheduling session is not properly configured.
- The scheduling priorities on the AP are in conflict.
- Scheduling is not applied to the target radio.

1.4.2 Configuring WLAN Scheduling

Configuration Effect

- Create a scheduling session, specify a scheduling interval, and apply this scheduling session to a WLAN to realize WLAN scheduling.

Configuration Steps

↘ Creating a Scheduling Session

- (Mandatory) In WLAN configuration mode, run the **schedule session *sid*** command to specify the scheduling Session ID of a WLAN.
- After a scheduling session is applied, if the message for the scheduling session is displayed, the specified WLAN interface will automatically enter or exit from the scheduling state as specified by the message type.

| | |
|------------------------------|---|
| Command | schedule session <i>sid</i> |
| Parameter Description | session <i>sid</i> : Indicates Session ID. It can be set to a value ranging from 1 to 8 on a fat AP. |
| Defaults | No scheduling session is applied on a WLAN. |
| Command Mode | Global configuration mode |
| Usage Guide | N/A |

↘ Specifying the Time Interval for a Scheduling Session

- Mandatory.

| | |
|------------------------------|--|
| Command | schedule session <i>sid</i> time-range <i>n</i> period <i>day1</i> [to <i>day2</i>] time <i>hh1:mm1</i> to <i>hh2:mm2</i> |
| Parameter Description | <p>session <i>sid</i>: Indicates Session ID. It can be set to a value ranging from 1 to 8 on a fat AP.</p> <p>time-range <i>n</i>: Indicates the number of a time interval, which ranges from 1 to 8.</p> <p>period <i>day1</i>: Indicates the start date of the scheduling session cycle, which can be set to { sun mon tue wed thu fri sat }.</p> <p>to <i>day2</i>: <i>day2</i> indicates the end date of the scheduling session cycle. By default, this parameter indicates that the scheduling cycle is one day.</p> <p>time <i>hh1:mm1</i> to <i>hh2:mm2</i>: Indicates the scheduling time period, and <i>hh1:mm1</i> and <i>hh2:mm2</i> indicate the start time and end time respectively in the unit of hours (ranging from 0 to 23) and minutes (ranging from 0 to 59).</p> |
| Defaults | By default, a scheduling session is not configured. |
| Command Mode | Global configuration mode |
| Usage Guide | N/A |

↘ Applying a Scheduling Session

- Mandatory.

| | |
|------------------------------|---|
| Command | schedule session <i>sid</i> |
| Parameter Description | <p>session <i>sid</i>: Indicates Session ID. It can be set to a value ranging from 1 to 8 on a fat AP.</p> |
| Defaults | No scheduling session is applied on a WLAN or radio. |
| Command Mode | WLAN configuration mode or Interface configuration mode |
| Usage Guide | N/A |

Verification

- Run **show running-config** to display configurations on RF scheduling.
- Check whether scheduling is still performed for a WLAN after a scheduling session expires.

Configuration

Example

N/A

Common Errors

- No scheduling session is created.
- The interval of the scheduling session is not properly configured.

2 Configuring Band Select

2.1 Overview

Band Select is a technology for optimizing access band distribution for STAs on a WLAN.

The Band Select function leads dual-band STAs to access the higher-capacity 5 GHz band to reduce the pressure on the 2.4 GHz band and improve user experience.

The Band Select function is suitable for the following scenario: dual-band APs are used to provide coverage, and the two RF interfaces of the APs operate at 2.4 GHz and 5 GHz respectively; meanwhile, a WLAN is mapped to the two RF interfaces of the APs and provides access service at the two bands simultaneously.

Protocols and Standards

- IEEE 802.11

2.2 Applications

N/A

2.3 Features

Basic Concepts

IEEE802.11 Communication Band

IEEE802.11 comprises two communication bands:

- 2.4 GHz (2.4 to 2.4835 GHz), where 802.11b/g/n resides
- 5 GHz (5.15 to 5.35 and 5.725 to 5.825 GHz), where 802.11a/n resides

With the popularization of WLANs, there are more and more wireless users. Many users use dual-band wireless clients (STAs) supporting both 2.4 GHz and 5 GHz. However, 802.11b/g is more widely applied than 802.11a. Many dual-band STAs use 2.4 GHz, causing congestion of 2.4 GHz and waste of 5 GHz. Actually, the 5 GHz band has a greater access capacity. The 2.4 GHz band has up to three non-overlapped channels, whereas the 5 GHz band provides more non-overlapped channels.

STA Scanning

There are two modes, namely, passive scanning and active scanning.

- **Passive scanning:** An STA monitors beacon frames sent by nearby APs on all channels of all supported bands. The beacon frames contain WLAN access information. The STA parses the information to learn about the WLANs that are available nearby.

- Active scanning: The STA broadcasts a Probe Request frame on all channels of all supported bands. After receiving the Probe Request frame, the APs providing WLAN access service sends a Probe Response frame including some WLAN information to the STA.

Generally, the STA summarizes the SSIDs of all discovered WLANs and provides an accessible WLAN list for users.

↘ **Dual-band STA**

WLAN network interface cards (WNICs) used by STAs to connect to WLANs are classified into a, b, g and n types, which indicate the 802.11 protocol types supported by the WNICs. 802.11a operates at 5 GHz, 802.11b/g at 2.4 GHz, and 802.11n at 5 GHz and 2.4 GHz.

Therefore, if the specification of a WNIC includes both a and b/g, this WNIC supports both the two bands, namely, a dual-band STA. A dual-band STA can access both the 5 GHz band and the 2.4 GHz band.

↘ **Dual-band AP**

A dual-band AP is able to access two bands. Therefore, a dual-band AP requires at least two RF interfaces, one for 5 GHz and the other for 2.4 GHz.

A WLAN enabled with Band Select must be mapped to the two RF interfaces of the dual-band AP and provides access service at the two bands.

Overview

| Feature | Description |
|---|---|
| Identifying STA Types | The Band Select function identifies whether an STA is a dual-band STA. |
| Controlling the Active Scanning Process | The Band Select function controls active scanning of the dual-band STA to prevent the STA from discovering WLANs of the 2.4 GHz band. |
| Rejecting Accessing the 2.4 GHz Band | The Band Select function rejects the dual-band STA from accessing the 2.4 GHz band and improves the chance of accessing the 5 GHz band. |

2.3.1 Identifying STA Types

To lead a dual-band STA to access the 5 GHz band, you should first identify whether the STA is a dual-band STA; that is, identify the band supported by the STA.

Working Principle

Active scanning is an approach for an STA to discover WLANs. When using active scanning, the STA sends a Probe Request frame on each supported channel. If the channel information in the Probe Request frame sent by the STA can be obtained, the bands supported by the STA can be identified.

For example, if an AP receives the Probe Request frame on channels 1-13, the AP learns that the STA supports the 2.4 GHz band. If the AP receives the Probe Request frame on channels 149-165, the AP learns that the STA supports the 5 GHz band.

Since a single-band AP can receive the Probe Request frame only at one band, only a dual-band AP can correctly identify the STA type. This is why the Band Select function requires a dual-band AP be used.

↘ **STA Classification Standards**

A dual-band AP classifies STAs based on the following standards:

- If the AP can receive the Probe Request frame from an STA both at the 2.4 GHz band and the 5 GHz band, this STA is a dual-band STA.
- If the AP can receive the Probe Request frame from this STA only at the 5 GHz band, the AP learns that this STA is a 5 GHz STA.
- If the AP can receive the Probe Request frame from this STA only at the 2.4 GHz band, the AP learns that this AP is a 2.4 GHz STA.

The AP must wait for a period of time to verify that no Probe Request frame is received at the band; therefore, identifying a single-band STA is time-consuming but does not affect the normal use by users. Among the three types of STAs, the first two types are called the dual-band STAs in the Band Select function and the last type is called the inhibition STAs.

 It takes a period of waiting time (fixed to 2 seconds) to determine whether a Probe Request frame is sent at the 5 GHz band. Due to different STA drivers, this time is not applicable to all dual-band STAs. Therefore, STA types may not be correctly identified in the beginning. As long as dual-band STAs can send Probe Request frames at the 5 GHz band later, the correct STA types can be identified.

📄 STA Information Saving

The STA information identified by a dual-band AP must be saved to provide the basis for subsequent responding policies.

Since Probe Request frames sent by STAs are broadcast packets, an AP may receive many Probe Request frames generally. It is unnecessary to save all the frames because some distant STAs may not access the AP. Therefore, the Band Select function saves only the information of STAs that may have access. The selection criterion is the Received Signal Strength Indication (RSSI) of STAs. Only those whose RSSI exceeds a threshold can access the AP, and only then does the identified information need to be saved.

📄 STA Information Aging

Users can configure the bands supported by some STAs; therefore, STA type may change during use.

Take an 802.11a/g/n-supported WNIC for example. The WNIC works as a dual-band STA in the beginning. However, a user disables its 802.11a mode or the support for the 5 GHz channels. Then, the WNIC changes to a single-band 2.4 GHz STA.

In this case, an aging mechanism needs to be used for the identified STA information. After a period of time, the previously identified STA information is discarded.

2.3.2 Controlling the Active Scanning Process

After identifying the bands supported by an STA, a dual-band AP can control the active scanning of the STA according to the STA information. The purpose is to prevent a dual-band STA from discovering 2.4 GHz WLANs and thus lead the dual-band STA to access the 5 GHz band.

Working Principle

During active scanning, the STA broadcasts a Probe Request frame. After receiving the Probe Request frame, an AP sends a Probe Response frame immediately to inform the STA of the accessible WLANs on this AP. During active scanning of a dual-band STA, the STA sends a Probe Request frame and waits for a Probe Response frame on the two bands. After the Band Select function is enabled, the AP controls the active scanning and adopts different response approaches according to actual situations.

➤ Active Scanning Before the Band Select Function Identifies STA Types

If the Band Select function is enabled for a WLAN, the WLAN may have different responses to active scanning of an STA. Before STA types are identified:

- The AP does not respond to Probe Request frames from the 2.4 GHz band.
- The AP responds to Probe Request frames from the 5 GHz band.

After receiving a Probe Request frame from the 2.4 GHz band, the AP cannot determine whether the STA supports the 5 GHz band. To prevent the STA from discovering that the WLAN provides access service at the 2.4 GHz band, the AP responds after the identification process ends.

If the AP receives a Probe Request frame from the 5 GHz band, it indicates that the STA supports the 5 GHz band. In this case, the AP sends a Probe Response frame immediately to tell the STA that WLAN provides access service at the 5 GHz band.

➤ Active Scanning After the Band Select Function Identifies STA Types

When the AP receives a Probe Request frame after identifying the STA type, the AP can find the source MAC address in the Probe Request frame stored on the AP.

- If the STA is a dual-band STA, the AP does not respond to a 2.4 GHz Probe Request; if the STA is an inhibition STA, the AP responds negatively
- The AP responds to a 5 GHz Probe Request .

Not responding to a 2.4 GHz Probe Request sent by a dual-band STA can prevent the dual-band STA from discovering that a WLAN provides access service at the 2.4 GHz band. In this way, the dual-band STA only discovers that the WLAN provides access service at the 5 GHz band. The dual-band STA has to select the 5 GHz band for access.

The AP must respond to the 2.4 GHz Probe Request from an inhibition STA. Since an inhibition STA supports only the 2.4 GHz band, the inhibition STA cannot identify a WLAN if the AP does not respond to the 2.4 GHz Probe Request. However, the response to an inhibition STA is negative.

A 5 GHz Probe Request is sent only by a dual-band STA. Therefore, the AP must send a Probe Response immediately to tell the WLAN to provide access service at the 5 GHz band.

➤ Negative Response to an Inhibition STA

The Band Select function always positively responds to 5 GHz Probe Requests, does not respond to 2.4 GHz Probe Requests sent by dual-band STAs, and responds to Probe Requests from inhibition STAs negatively.

Figuratively speaking, a negative response is a discounted response. For example, when receiving multiple Probe Requests consecutively, the AP sends only one Probe Response.

The negativity depends on two parameters: STA scanning cycle threshold and the probe count of the inhibition STA.

The STA scanning cycle refers to the time for scanning all supported channels during the active scanning of an STA. This time depends on the driver of the STA and varies with STAs. The STA scanning cycle is a value configured by users, which is considered the minimum STA scanning cycle. If the scanning cycle of an STA is smaller than this value, two consecutive scanning cycles may be considered to be one by an AP. This parameter is useful when some STAs send multiple Probe Requests within one scanning cycle.

Example: Assume that an STA scans all channels every 150 milliseconds and sends two Probe Request frames consecutively on each channel. If an AP does not specify the minimum scanning cycle of the STA, the AP cannot identify

whether the STA sends two frames within the same scanning cycle or sends the two frames in two consecutive scanning cycles. If the AP sets the minimum scanning cycle of the STA to 200 milliseconds, the two frames are considered to be sent within the same scanning cycle because their interval is shorter than 200 milliseconds. The probe count of the STA on the AP is 1. Since the specified minimum scanning cycle (200 milliseconds) and the actual scanning cycle (150 milliseconds) are different, the counts are also different. Assume that the STA performs scanning for three consecutive cycles, the count on the AP will be 2 because the first two cycles are considered to be one. However, this problem does not cause inconvenience to users.

The probe count of an STA reflects the negativity of the response. This parameter indicates that an AP sends one response after an inhibition STA performs active scanning for multiple cycles. For example, if the default value is 2, the WLAN on the AP sends a Probe Response frame after the STA performs scanning for two consecutive cycles.

2.3.3 Rejecting Accessing the 2.4 GHz Band

 The Band Select function controls only the active scanning of an STA, but cannot prevent the STA from discovering a 2.4 GHz WLAN through passive scanning. Therefore, some dual-band STAs can still discover 2.4 GHz WLANs and attempt to access the WLANs. In this case, the Band Select function may fail.

The Band Select function can reject 2.4 GHz access requests from dual-band STAs to improve the chance for dual-band STAs accessing the 5 GHz band.

 Rejecting a dual-band STA's 2.4 GHz access request helps facilitate the Band Select function; however, the Band Select function cannot be 100% successful.

Working Principle

After an STA discovers a WLAN for a user to access the WLAN, the STA sends an Authentication Request to the AP at first. Then, the AP sends an Authentication Response to permit or reject the STA's authentication request.

The Band Select function processes the Authentication Request. If the Authentication Request is sent by a dual-band STA at the 2.4 GHz band, the function can reject the Authentication Request until the dual-band STA sends an Authentication Request from the 5 GHz band. Thus, the STA is led to access the 5 GHz band.



Generally, when a dual-band STA searches for access, the STA sends one or more Authentication Requests at a band and waits for responses. If the STA does not receive responses or fails in access, the STA sends Authentication Requests at the other band and waits for responses. However, some dual-band STAs send Authentication Requests only at the 2.4 GHz. For high availability, you can use the Band Select function to set the rejecting count for a dual-band STA.

Assume that a dual-band STA sends Authentication Requests for M times before changing the band, and the rejecting count is set to N . If the dual-band STA attempts to access the 5 GHz band at first, the STA can access the 5 GHz band immediately. If the dual-band STA attempts to access the 2.4 GHz band at first, the STA can access the 5 GHz band only if N is equal to or greater than M ; otherwise, the STA accesses the 2.4 GHz band. No matter which band a dual-band STA accesses, if the dual-band STA attempts to access the 2.4 GHz band at first, $\min(M, N)$ Authentication Requests are rejected or ignored. As a result, the STA's access is delayed. The delay time depends on the driver of the STA. For example, if the STA sends Authentication Requests at the interval of 100 milliseconds and four Authentication Requests are ignored, the access of the STA will be delayed for 400 milliseconds.

 When the Band Select function rejects the access request of a dual-band STA while another access control module such as load balance accepts the access request, the STA will still gain access. This is because the Band Select

function plays only the "leading" role during STA access and has a low priority. When the Band Select function conflicts with other functions, the other functions shall prevail.

2.4 Configuration

| Configuration | Description and Command |
|---|--|
| Configuring Band Select |  (Mandatory) It is used to enable the Band Select function for a WLAN. |
| | band-select enable Enables the Band Select function. |
| |  (Optional) It is used to set the parameters of the Band Select function. |
| | band-select acceptable-rssi Configures the minimum RSSI for the Band Select function. |
| | band-select access-denial Configures the rejecting count for a dual-band STA's 2.4 GHz access requests. |
| | band-select age-out Configures the aging time of STA information. |
| | band-select probe-count Configures the probe count of an inhibition STA. |
| | band-select scan-cycle Configures the scanning cycle threshold of an STA |

2.4.1 Configuring Band Select

Configuration Effect

- Enable the Band Select function for a WLAN to lead dual-band STAs to access the 5 GHz band.

Notes

- N/A

Configuration Steps

▾ Enabling the Band Select Function for a WLAN

- Mandatory.
- If there is no special requirement, enable this function on a fat AP.

| | |
|---------------------|---------------------------------------|
| Command | band-select enable |
| Parameter | N/A |
| Description | |
| Defaults | The Band Select function is disabled. |
| Command Mode | WLAN configuration mode |
| Usage Guide | N/A |

↘ Configuring the Minimum RSSI for the Band Select Function

- (Optional) It is configured when you want to adjust the coverage of the Band Select function.
- If there is no special requirement, enable this function on a fat AP.
- The higher the value, the smaller the coverage of the Band Select function; the lower the value, the larger the coverage of the Band Select function. However, if the value exceeds a certain limit, the STA signals that gain access may be too weak, causing the connection rate of the entire network to slow down.

| | |
|------------------------------|---|
| Command | band-select acceptable-rssi <i>value</i> |
| Parameter Description | <i>value</i> : Specifies the minimum SSID for the Band Select function, ranging from -100 to -50 dBm. |
| Defaults | The default value is -80 dBm |
| Command Mode | Global configuration mode |
| Usage Guide | N/A |

↘ Configuring the Rejecting Count for a Dual-Band STA's 2.4 GHz Access Requests

- (Optional) It is configured when it is necessary to reject the 2.4 GHz access request of dual-band STAs. If many STAs fail in access or it takes much time to access, configure this parameter to a smaller value or to 0.
- If there is no special requirement, enable this function on a fat AP.
- The more the rejecting count is, the more difficult the dual-band STA accesses the 2.4 GHz band, and the later the STA accesses the 2.4 GHz band. On the other hand, the less the rejecting count is, the easier the dual-band STA accesses the 2.4 GHz band, and the sooner the STA accesses the 2.4 GHz band.

| | |
|------------------------------|---|
| Command | band-select access-denial <i>value</i> |
| Parameter Description | <i>value</i> : Specifies the rejecting count for a dual-band STA's 2.4 GHz access requests, ranging from 0 to 10. |
| Defaults | The default value is 2 |
| Command Mode | Global configuration mode |
| Usage Guide | N/A |

↘ Configuring the Aging Time of STA Information

- (Optional) If no dual-band STAs change to single-band 2.4 GHz STAs, configure a longer aging time. Otherwise, configure a shorter aging time. If it is uncertain, use the Defaults.
- If there is no special requirement, enable this function on a fat AP.
- The longer the STA information aging time, the longer the lifecycle of STA information, and the less sensitive of an AP to STA's band change. The shorter the STA information aging time, the shorter the lifecycle of STA information, and the more sensitive of an AP to STA's band change.

| | |
|------------------------------|--|
| Command | band-select age-out { dual-band <i>value</i> suppression <i>value</i> } |
| Parameter Description | dual-band <i>value</i> : Specifies the aging time of dual-band STA information, ranging from 20 to 120 seconds. suppression <i>value</i> : Specifies the aging time of inhibition STA information, ranging from 10 to 60 seconds. |

| | |
|---------------------|---|
| Defaults | The aging time of dual-band STA information is 60 seconds and the aging time of inhibition STA information is 20 seconds. |
| Command Mode | Global configuration mode |
| Usage Guide | It is recommended that the aging time of dual-band STA information be set to twice or three times that of inhibition STA information. |

✚ Configuring the Probe Count of an Inhibition STA

- (Optional) If a single-band 2.4 GHz STA cannot discover a WLAN for a long time, this parameter should be set to a smaller value.
- If there is no special requirement, enable this function on a fat AP.
- The greater the probe count of an STA, the stronger inhibition the Band Select function performs on an inhibition STA, and the more difficult the inhibition STA discovers a WLAN. On the other hand, the smaller the probe count of an STA, the weaker inhibition the Band Select function performs on an inhibition STA, and the easier the inhibition STA discovers a WLAN.

| | |
|------------------------------|--|
| Command | band-select probe-count <i>value</i> |
| Parameter Description | <i>value</i> : Specifies the probe count of an inhibition STA, ranging from 1 to 10. |
| Defaults | The default value is 2. |
| Command Mode | Global configuration mode |
| Usage Guide | N/A |

✚ Configuring the Scanning Cycle Threshold of an STA

- (Optional) If a single-band 2.4 GHz STA cannot discover a WLAN for a long time, this parameter should be set to a smaller value. If it is uncertain, use the Defaults.
- If there is no special requirement, enable this function on a fat AP.
- The greater the scanning cycle threshold of an STA, the more slowly the probe count of the STA increases, and the more difficult the STA discovers a WLAN. On the other hand, the smaller the scanning cycle threshold of the STA, the more quickly the probe count of the STA increases, and the easier the STA discovers a WLAN.

| | |
|------------------------------|---|
| Command | band-select scan-cycle <i>value</i> |
| Parameter Description | <i>value</i> : Specifies the scanning cycle threshold of an STA, ranging from 1 to 1000 milliseconds. |
| Defaults | The default value is 200 milliseconds. |
| Command Mode | Global configuration mode |
| Usage Guide | N/A |

Verification

- Run the **show band-select configuration** command to display parameters of the Band Select function.
- Run the **show running-config** command to check whether the Band Select function is enabled.
- After a period of running, run the **show band-select statistics** command to check the statistics.

- Check whether the Band Select function controls the active scanning process by capturing packets.

Configuration

Example

N/A

Common Errors

- The parameters are improper.
- The Band Select function is not enabled.
- One of the two RF interfaces of a dual-band AP is disabled.

2.5 Monitoring

Displaying

| Description | Command |
|---|---------------------------------------|
| Displays the configuration of the Band Select function. | show band-select configuration |
| Displays the statistics of the Band Select function. | show band-select statistics |



WLAN Security Configuration

1. Configuring Robust Security Network Architecture
2. Configuring CPU Protection
3. Configuring NFPP

1 Configuring Robust Security Network Architecture

1.1 Overview

The Robust Security Network Architecture (RSNA) function provides security mechanisms for WLANs.

A WLAN uses open media and public electromagnetic waves as a carrier to transmit data signals. Neither communication party is connected with a cable. If transmission links are not properly protected through encryption, data transmission will be at great risk. Therefore, security mechanisms are especially important in a WLAN.

To enhance the security, a WLAN should be provided with at least the authentication and encryption mechanisms:

- Authentication mechanism: The authentication mechanism is used to authenticate users and allow only specified users (authorized users) to use network resources.
- Encryption mechanism: The encryption mechanism is used to encrypt data on wireless links to ensure that WLAN data can be received and understood only by expected users.

Protocols and Standards

- IEEE Standard for Information technology – Telecommunications and information exchange between systems – Local and metropolitan area networks – Specific requirements -2007
- WI-FI Protected Access – Enhanced Security Implementation Based On IEEE P802.11i Standard -Aug 2004
- Information technology – Telecommunications and information exchange between systems—Local and metropolitan area networks—Specific requirements – 802.11, 1999 IEEE Standard for Local and metropolitan area networks "Port-Based Network Access Control" 802.1X™ -2004
- 802.11i IEEE Standard for Information technology –Telecommunications and information exchange between systems –Local and metropolitan area networks – Specific requirements

1.2 Applications

| Application | Description |
|--|--|
| WEP Encryption | In a small WLAN that has a lower requirement for security; static WEP encryption can be used to protect wireless data communication. |
| PSK Access Authentication | For small and medium-sized enterprise networks or family users, access authentication based on pre-shared keys can be used to enhance the security of WLANs. |
| 802.1X Access Authentication | For a scenario that has a higher requirement for security or unified management, port-based network access control can be used. |

1.2.1 WEP Encryption

Scenario

In a small WLAN that has a lower requirement for security, WEP encryption can be used.

WEP encryption can use the open-system or shared-key link authentication mode. Their differences are as follows:

- When open-system link authentication is used, WEP keys can be used only for data encryption. Even if inconsistent keys are configured, users can go online; however, data transmitted after the users go online is discarded by the receiver due to key inconsistency.
- When shared-key link authentication is used, WEP keys are used for link authentication and data encryption. If inconsistent keys are configured, link authentication fails and the client cannot go online.

Figure 1-1 shows the scenario of static WEP encryption.

Figure 1-1

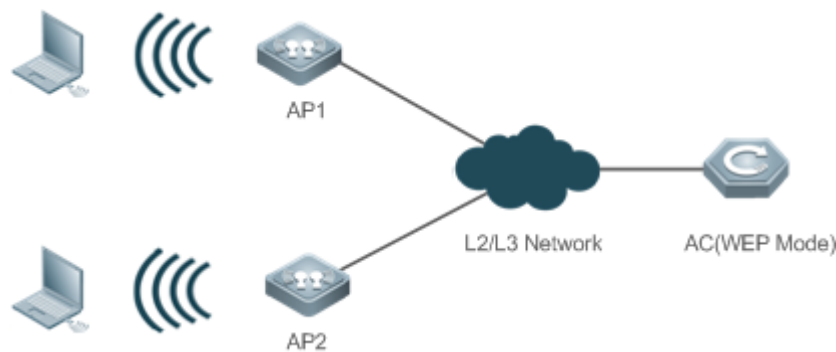

Deployment

- Configure WLAN on AP1 and AP2.
- Configure WEP encryption on AP1 and AP2 in WLAN security configuration mode.

1.2.2 PSK Access Authentication

Scenario

Small and medium-sized enterprise networks or family users can use the WPA or WPA2 standard to enhance WLAN security. The simplest method is to use the pre-shared key authentication (referred to as WPA-PSK and WPA2-PSK respectively). In this case, WPA is similar to WEP, but users can achieve higher security through WPA and 802.11i, including more robust authentication and better encryption algorithms.

In PSK authentication, the same pre-shared key should be configured for an STA and an AP to establish connection and communication. No additional authentication server is required.

Figure 1-2 shows the scenario of PSK authentication.

Figure 1-2

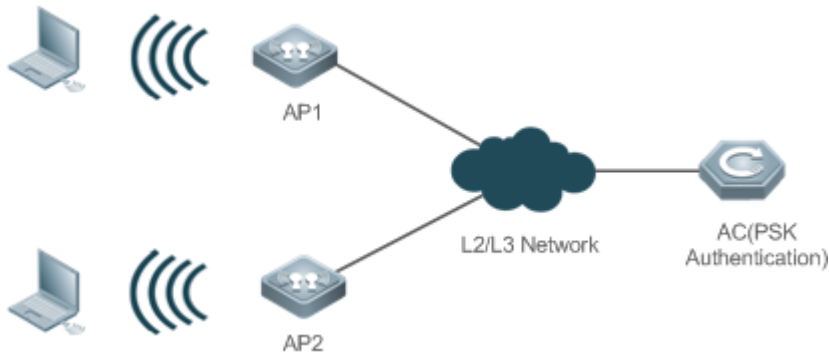

Deployment

- Configure WLAN on AP1 and AP2.
- Configure PSK authentication on AP1 and AP2 in WLAN security configuration mode.
- Use this authentication with Web authentication to support Web authentication and charging.

1.2.3 802.1X Access Authentication

Scenario

In a scenario that has a higher requirement for security, 802.1X authentication can be used.

802.1X is a port-based network access control protocol. This authentication mode is used to authenticate and control STAs at the port level. STAs connected to the ports can access a WLAN if they pass the authentication; otherwise, the STAs fail to access the WLAN.

Authentication client software needs to be installed on terminals to perform 802.1X authentication. However, in some cases, some devices cannot be installed with the software, for example, wireless printers. For the sake of network management and security, although these terminals have no 802.1X authentication client software, administrators need to control the access of these terminals. MAC Authentication Bypass (MAB) provides a solution for this application.

After the MAB function is deployed for a WLAN, a wireless device can automatically probe the MAC address of a connected terminal and uses the MAC address to initiate a request to the authentication server.

Figure 1-3 shows the scenario of 802.1X authentication.

Figure 1-3

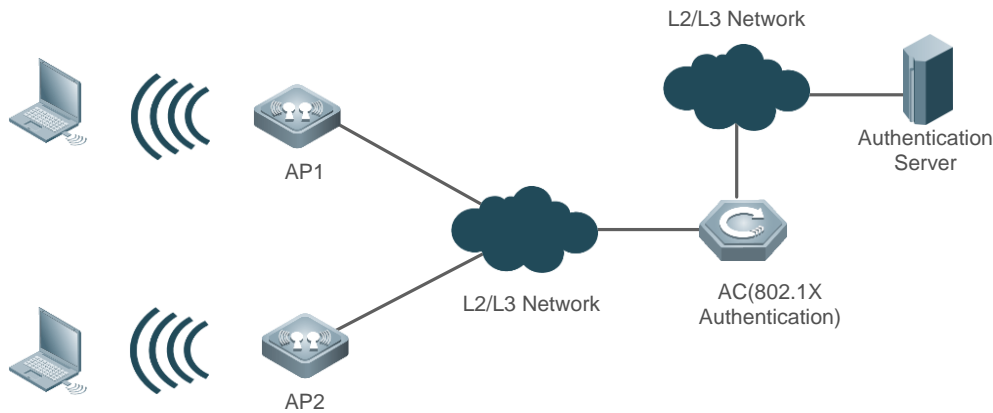

Deployment

- Configure WLAN on AP1 and AP2.
- Configure authentication server on AP1 and AP2.
- Configure 802.1X authentication on AP1 and AP2 in WLAN security configuration mode.

1.3 Features

Basic Concepts

WPA

Wi-Fi Protected Access (WPA) is a wireless security draft defined by the Wi-Fi Alliance. The IEEE802.11i standard is compatible with this draft.

RSN

The IEEE802.11i standard defines the concept of Robust Security Network (RSN); and makes many improvements against various defects of the WEP encryption mechanism. The functions are equal to WPA2 launched by the Wi-Fi Alliance.

TKIP

The Temporal Key Integrity Protocol (TKIP) is an enhancement on WEP security. TKIP provides key mixing, message integrity check and key mechanism re-generation for each packet, thus eliminating hidden risks of WEP.

AES

Advanced Encryption Standard (AES) is a new encryption standard published by the National Institute of Standards and Technology (NIST) of the United States. On October 2, 2000, the Rijndael algorithm designed by Joan Daemen and Vincent Rijmen from Belgium won with its excellent performance and anti-attack capabilities, and became the new-generation encryption standard AES.

CCMP

Counter CBC-MAC Protocol (CCMP) uses AES, which is safer than TKIP.

AKM

Authentication and Key Management (AKM) is an access authentication mode for users to access a WLAN.

Overview

| Feature | Description |
|--|--|
| Link Verification | Verify the security of a wireless link before an STA associates with a WLAN. |
| Access Authentication | Perform authentication for an STA that accesses a WLAN. |
| Wireless Data Encryption | Implement security protection for communication data of an STA that accesses a WLAN. |

1.3.1 Link Verification

Link verification refers to 802.11 authentication, which is a low-level authentication mechanism. Link verification is performed when an STA associates with an AP over 802.11, which is earlier than access authentication. Before accessing a WLAN, the STA must be authenticated over 802.11. 802.11 authentication marks the beginning of the handshake process when an STA accesses a WLAN and the first step for network connection.

The IEEE 802.11 standard defines two approaches to link authentication:

- Open-system link authentication
- Shared-key link authentication

Working Principle

Open-System Link Authentication

Open-system link authentication allows all users to access a WLAN. In this sense, no data protection is provided, which means that no authentication is performed. In other words, if the authentication mode is set to open-system authentication, all STAs that request authentication can pass the authentication.

Open-system link authentication comprises two steps:

Step 1: An STA requests authentication. The STA sends an authentication request that contains the ID (usually the MAC address) of the STA.

Step 2: An AP returns the authentication result. The AP sends an authentication response that contains information indicating whether the authentication succeeds or fails. If the authentication succeeds, the STA and AP pass the bidirectional authentication.

Figure 1-4

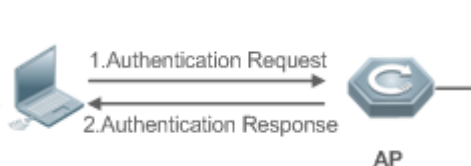

Shared-key Link Authentication

Shared-key link authentication is another authentication mechanism in addition to the open-system link authentication. Shared-key link authentication requires that the same shared key be configured for an STA and an AP. The shared-key link authentication can be configured only in static WEP encryption whereas the open-system link authentication is available in all the other modes.

The process of shared-key link authentication is as follows:

Step 1: An STA sends an authentication request to an AP.

Step 2: The AP generates a Challenge packet (a string) at random and sends the packet to the STA.

Step 3: The STA copies the received string to a new message, encrypts the message with a key and then sends the encrypted message to the AP.

Step 4: After receiving the message, the AP decrypts the message with the key, and then compares the decrypted string with the string sent to the STA. If the two strings are the same, it indicates that the STA has the same shared key as that on the AP and the shared-key authentication succeeds; otherwise, the shared-key authentication fails.

Figure 1-5

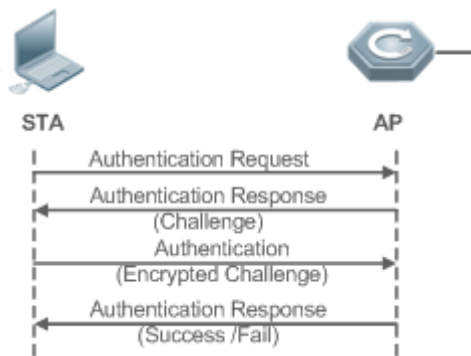

1.3.2 Access Authentication

Access authentication is a solution that enhances WLAN security.

After an STA is associated with an AP, whether the STA can use the service provided by the AP depends on the result of access authentication. If the STA passes the authentication, the AP enables the logical port for the STA; otherwise, the STA is not allowed to access the WLAN.

The IEEE 802.11 standard defines two access authentication approaches:

- PSK access authentication
- 802.1X access authentication

Working Principle

PSK Access Authentication

Pre-shared Key (PSK) is an 802.11i authentication mode, which performs authentication with pre-defined static keys. This authentication approach requires that an STA and an AP be configured with the same pre-shared key. If their keys are the same, the PSK access authentication succeeds; otherwise, the PSK access authentication fails.

📌 802.1X Access Authentication

802.1X is a port-based network access control protocol. This authentication approach is used to authenticate and control the STAs at the port level. STAs connected to the ports can access resources in a WLAN if they pass the authentication; otherwise, the STAs cannot access resources in the WLAN.

A WLAN system with the 802.1X authentication function must provide the following elements to implement port-based authentication and authorization:

- Authentication client

Authentication client is generally installed on the STA. When the user wants to access the network, he activates the client program and enters the user name and password. Then, the client program sends a connection request.

- Authenticator

An authenticator means an AP or a communication device functioning as an AP. It is responsible for uploading and pushing user authentication information and enables or disables a port based on the authentication result.

- Authentication server

The authentication server checks whether a user has the right to use the services provided by the network system based on his identification information (user name and password), and enables or disables a port to the authentication system based on the authentication result.

MAB authentication uses a MAC address as the username to initiate a request to the authentication server. Therefore, it is not necessary for the terminal to install the client.

1.3.3 Wireless Data Encryption

Compared with a wired network, a wireless network is prone to greater security risks. Within an area, all WLAN devices share the same transmission medium and any device can receive data from all the other devices. This feature poses threat to WLAN data.

The IEEE 802.11i protocol defines the following encryption algorithms:

- WEP encryption
- TKIP encryption
- AES encryption

Working Principle

📌 WEP Encryption

Wired Equivalent Privacy (WEP) is a data encryption mode specified in the original IEEE 802.11 standard, and is the basis for WLAN security authentication and encryption. WEP is used to promote the privacy of data exchanged between authorized users in a WLAN and prevent the data from being stolen.

WEP uses the RC4 algorithm to promote data privacy and implements authentication by using a shared key. WEP does not specify a key management scheme. Generally, keys are configured and maintained manually. WEP that does not provide a key distribution mechanism is called manual WEP or static WEP.

A WEP encrypted key may contain 64 bits or 128 bits. The 24-bit Initialization Vector (IV) is generated by the system. Therefore, a shared key to be configured on an AP and an STA consists of only 40 bits or 104 bits. In practice, the 104-bit WEP keys are widely used to replace the 40-bit WEP keys. WEP using 104-bit keys are called WEP-104. Although WEP-104 increases the security of WEP encryption, WEP encryption is prone to security risks due to limitations of the RC encryption algorithm and statically configured keys. WEP encryption cannot ensure the confidentiality and integrity of data or access authentication.

📌 TKIP Encryption

Temporal Key Integrity Protocol (TKIP) is a temporary makeshift solution created by the IEEE 802.11 organization for fixing the WEP encryption mechanism. Like WEP encryption, TKIP encryption also uses the RC4 algorithm. But compared with WEP encryption, TKIP encryption can provide much safer protection for WLAN services in the following aspects:

A static WEP key is manually configured and all users within the same service area share the same key. A TKIP key is generated through dynamic negotiation, and each packet has a unique key.

- TKIP increases the key length from 40 bits to 128 bits, and the IV length from 24 bits to 48 bits, thus improving the security of WEP encryption.
- TKIP supports Message Integrity Check (MIC) and the replay prevention function.



📌 AES Encryption





The Counter mode with CBC-MAC Protocol (AES-CCMP) is the most advanced wireless security protocol oriented to the public.

The IEEE 802.11i standard requires that CCMP be used to provide four security services, namely, authentication, confidentiality, integrity, and replay prevention. CCMP uses the 128-bit Advanced Encryption Standard (AES) to implement confidentiality and uses the CBC-MAC to ensure data integrity and authentication.

As a new advanced encryption standard, AES uses the symmetrical block encryption technology to provide better encryption performance than the RC4 algorithm in WEP/TKIP. It is the new-generation encryption technology that replaces WEP and brings more powerful security protection for WLANs.

1.4 Configuration

| Configuration | Description and Command | |
|---|---|---|
| Configuring Static WEP |  (Mandatory) It is used to enable static WEP encryption. | |
| | <table border="1"> <tr> <td>security static-wep-key encryption</td> <td>Enables static WEP for a WLAN and configures a static WEP key.</td> </tr> </table> | security static-wep-key encryption |
| security static-wep-key encryption | Enables static WEP for a WLAN and configures a static WEP key. | |
| Configuring WPA |  (Optional) It is used to configure the link authentication mode. | |
| | <table border="1"> <tr> <td>security static-wep-key authentication</td> <td>Configures the link authentication mode of static WEP.</td> </tr> </table> | security static-wep-key authentication |
| security static-wep-key authentication | Configures the link authentication mode of static WEP. | |

| Configuration | Description and Command | |
|---|---|--|
| Authentication | security wpa | Configures WPA authentication. |
| | security wpa ciphers | Configures the encryption mode of WPA authentication. |
| | security wpa akm | Configures the access authentication mode for WPA authentication. |
| |  (Optional) It is used to configure a shared key for WPA PSK authentication. | |
| | security wpa akm psk set-key | Configures a shared key for WPA PSK authentication. |
| Configuring RSN Authentication |  (Mandatory) It is used to enable RSN authentication. | |
| | security rsn | Configures RSN authentication. |
| | security rsn ciphers | Configures the encryption mode for RSN authentication. |
| | security rsn akm | Configures the access authentication mode for RSN authentication. |
| |  (Optional) It is used to configure a shared key for RSN PSK authentication. | |
| security rsn akm psk set-key | Configures a shared key for RSN PSK authentication. | |
| Configuring MAB Authentication |  (Optional) It is used to configure MAB authentication. | |
| | dot1x-mab | Enables MAB authentication. |
| Configuring Authentication Parameters |  (Optional) It is used to configure key interaction parameters and the jitter prevention time in Web authentication. | |
| | authtimeout forbidcount | Configures the association forbidding count after four-way handshake key interaction fails. |
| | authtimeout forbidtime | Configures the association forbidding interval after four-way handshake key interaction fails. |
| | authtimeout groupcount | Configures the multicast key negotiation packet re-transmission count. |
| | authtimeout grouptime | Configures the timeout duration of multicast key negotiation packets. |
| | authtimeout paircount | Configures the unicast key negotiation packet re-transmission count. |
| | authtimeout pairtime | Configures the timeout duration of unicast key negotiation packets. |
| webauth prevent-jitter | Configures the jitter prevention time of Web authentication. | |

1.4.1 Configuring Static WEP

Configuration Effect

- Enable static WEP encryption and provide WEP encryption protection for WLAN data.
- Configure the link authentication mode.

Notes

- The link authentication mode must be configured after static WEP encryption is enabled.
- In the security mode of a WLAN, static WEP encryption cannot be configured together with other authentication encryption.
- Only one WLAN can be configured with static WEP encryption

Configuration Steps

↳ Enabling Static WEP

- Mandatory.
- Enable static WEP encryption in WLAN security configuration mode on the AP.

| | |
|------------------------------|---|
| Command | security static-wep-key encryption <i>key-length</i> { ascii hex } <i>key-index</i> <i>key</i> |
| Parameter Description | <i>key-length</i> : Specifies the key length, which can be 40 bits or 104 bits. ascii : Specifies that the WEP key is ASCII code. hex : Specifies that the WEP key is hexadecimal code. <i>key-index</i> : Specifies the key index, ranging from 1 to 4. <i>Key</i> : Specifies key data. |
| Defaults | Static WEP is disabled by default. |
| Command Mode | WLAN security configuration mode |
| Usage Guide | This command is used to configure a static WEP key and enable static WEP. This command can be configured repeatedly, but only the last configuration takes effect. The key length must be the same as the <i>key-length</i> parameter in the command. |

↳ Configuring the Link Authentication Mode

- (Optional) The default link authentication mode is open-system link authentication. This command can be used to configure shared-key link authentication.
- Enable static WEP encryption in security configuration mode on the AP.
- The link authentication mode can be configured only after static WEP encryption is enabled. After configuring the sharedkey link authentication mode, set the link authentication mode to shared key link authentication on the STA; otherwise, the STA cannot access the WLAN.

| | |
|------------------|--|
| Command | security static-wep-key authentication { open share-key } |
| Parameter | open : Configures open-system link authentication. |

| | |
|---------------------|---|
| Description | share-key: Configures shared key link authentication. |
| Defaults | An STA accesses a WLAN by using open-system link authentication by default. |
| Command Mode | WLAN security configuration mode |
| Usage Guide | Configure the link authentication mode after configuring a static WEP key. The link authentication mode cannot be configured for other security configuration modes than static WEP. |

Verification

Run the **show running-config | begin wlansec wlan_id** command to check whether the configuration takes effect.

Configuration Example

Configuring Static WEP Encryption and Using Shared-Key Link Authentication for WLAN 1

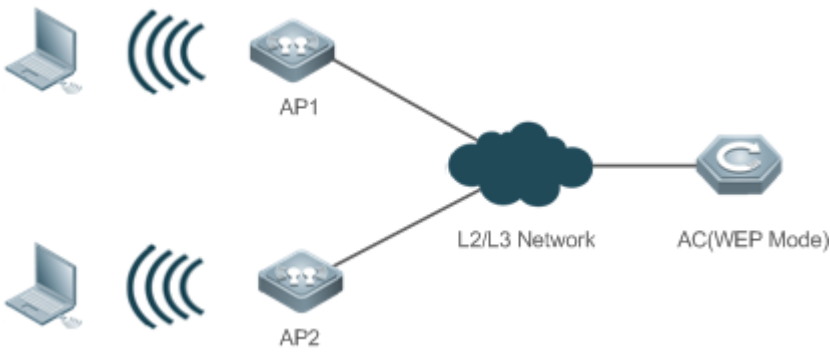
| | |
|---------------------------------------|--|
| <p>Scenario Figure 1-6</p> |  <p>In Fat AP mode, configure WLAN 1 on AP1 and AP2, and configure the security policies 1 as follows:</p> <ol style="list-style-type: none"> 1. Enable static WEP encryption. 2. Configure shared-key link authentication. |
| <p>Configuration Steps</p> | <ul style="list-style-type: none"> ● Access the security configuration mode of WLAN 1. ● Enable static WEP encryption and configure a WEP key. ● Set the link authentication mode to shared-key link authentication. |
| <p>AP</p> | <pre>Ruijie(config)#wlansec 1 Ruijie(config-wlansec)#security static-wep-key encryption 40 ascii 1 12345 Ruijie(config-wlansec)#security static-wep-key authentication share-key</pre> |
| <p>Verification</p> | <p>Run the show running-config begin wlansec wlan_id command to check whether the configuration takes effect.</p> |
| <p>AP</p> | <pre>Ruijie#show running-config begin wlansec 1 wlansec 1 security static-wep-key encryption 40 ascii 1 12345</pre> |

```
security static-wep-key authentication share-key
!
```

Common Errors

- The configured key length is inconsistent with the specified key length.
- Static WEP is configured for multiple WLANs.
- The link authentication mode is configured before static WEP is enabled.

1.4.2 Configuring WPA Authentication

Configuration Effect

- Enable WPA authentication for a WLAN.
- Specify the access authentication mode and encryption mode in WPA authentication.

Notes

- When WPA authentication is used, the encryption mode and access authentication mode must also be configured.
- If the access authentication mode is set to PSK, a PSK key must be configured.
- In the security mode of a WLAN, WPA authentication cannot be configured with WEP authentication.

Configuration Steps

▾ Configuring WPA Authentication

- Mandatory.
- Enable WPA authentication in WLAN security configuration mode on the AP.

| | |
|---------------------|--|
| Command | security wpa { enable disable } |
| Parameter | enable: Enables WPA authentication. |
| Description | disable: Disables WPA authentication. |
| Defaults | WPA authentication is disabled by default. |
| Command Mode | WLAN security configuration mode |
| Usage Guide | The encryption mode and access authentication mode can be configured in WPA authentication only after WPA authentication is enabled; otherwise, the configuration does not take effect. When WPA authentication is used, the encryption mode and access authentication mode must also be configured. If either the encryption mode or the access authentication mode is configured or neither of them is configured, STAs cannot access a WLAN. |

▾ Configuring the Encryption Mode of WPA Authentication

- Mandatory.

- It is configured in WLAN security configuration mode on the AP.
- The encryption mode of WPA authentication can be configured only after WPA authentication is enabled. The AES and TKIP encryption modes can be enabled at the same time in WLAN security configuration mode. After an encryption mode is configured for a WLAN, communication data between an STA and the WLAN is protected by the corresponding encryption mode.

| | |
|------------------------------|--|
| Command | security wpa ciphers { aes tkip } { enable disable } |
| Parameter Description | aes: Configures the AES encryption mode. tkip: Configures the TKIP encryption mode. enable: Enables the encryption mode of WPA authentication. disable: Disables the encryption mode of WPA authentication. |
| Defaults | No encryption mode is configured by default. |
| Command Mode | WLAN security configuration mode |
| Usage Guide | This command is used to enable an encryption mode of WPA authentication, which can be AES or TKIP. The AES and TKIP encryption modes can be enabled at the same time in WLAN security configuration mode. |

↘ Configuring the Access Authentication Mode of WPA authentication

- Mandatory.
- It is configured in WLAN security configuration mode on the AP.
- The access authentication mode can be configured only after WPA authentication is enabled. Only one access authentication mode can be enabled for a WLAN in security configuration mode. An STA can access a WLAN that is enabled with access authentication only after passing the access authentication.

| | |
|------------------------------|---|
| Command | security wpa akm { psk 802.1x } { enable disable } |
| Parameter Description | psk: Sets the access authentication mode to pre-shared key authentication. 802.1x: Sets the access authentication mode to 802.1X authentication. enable: Enables the access authentication mode of WPA authentication. disable: Disables the access authentication mode of WPA authentication. |
| Defaults | No access authentication mode is configured by default. |
| Command Mode | WLAN security configuration mode |
| Usage Guide | The access authentication mode can be configured only after WPA authentication is enabled. Only one access authentication mode can be enabled for a WLAN in security configuration mode. |

↘ Configuring a Shared Key for WPA Authentication

- (Optional) It must be configured when WPA PSK authentication is enabled.
- It is configured in WLAN security configuration mode on the AP.

| | |
|------------------------------|--|
| Command | <code>security wpa akm psk set-key { ascii <i>ascii-key</i> hex <i>hex-key</i> }</code> |
| Parameter Description | <p>ascii: Specifies that the PSK key is ASCII code.</p> <p><i>ascii-key:</i> Specifies a key in the ASCII format, consisting of 8 to 63 ASCII characters.</p> <p>hex: Specifies that the PSK key is hexadecimal code.</p> <p><i>hex-key:</i> Specifies a key in the hexadecimal format, consisting of 64 characters.</p> |
| Defaults | N/A |
| Command Mode | WLAN security configuration mode |
| Usage Guide | <p>This shared key takes effect only when PSK authentication is enabled.</p> <p>A key in the ASCII format consists of 8 to 63 characters.</p> <p>A key in the hexadecimal format consists of 64 characters.</p> |

Verification

Run the `show running-config | begin wlansec wlan_id` command to check whether the configuration takes effect.

Configuration Example

Configuring WPA PSK Authentication, AES Encryption and Key 12345678 for WLAN 1

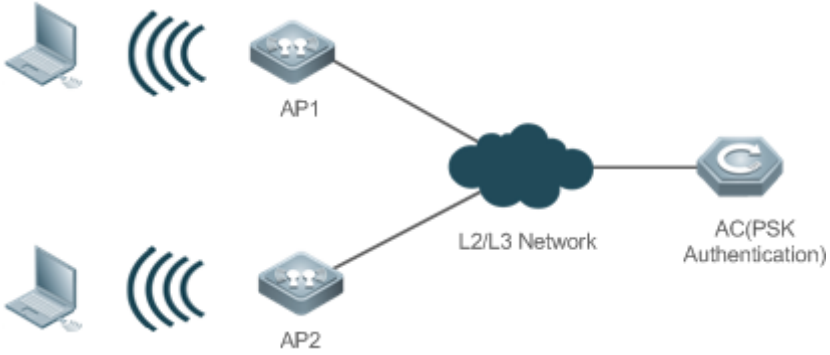
| | |
|---------------------------------------|---|
| <p>Scenario Figure 1-7</p> |  <p>In Fat AP mode , configure the security policies of WLAN 1 on AP1 and AP2 as follows:</p> <ol style="list-style-type: none"> 1. Configure WPA PSK authentication. 2. Configure the AES encryption mode. 3. Configure the shared key 12345678. |
| <p>Configuration Steps</p> | <ul style="list-style-type: none"> ● Access security configuration mode of WLAN 1. ● Enable WPA authentication. ● Configure the AES encryption mode for WPA authentication. ● Configure the PSK access authentication mode for WPA authentication. ● Configure the PSK key 12345678. |
| <p>AP</p> | <pre>Ruijie(config)#wlansec 1 Ruijie(config-wlansec)#security wpa enable Ruijie(config-wlansec)#security wpa ciphers aes enable</pre> |

| | |
|---------------------|---|
| | <pre>Ruijie(config-wlansec)#security wpa akm psk enable Ruijie(config-wlansec)#security wpa akm psk set-key ascii 12345678</pre> |
| Verification | Run the show running-config begin wlansec <i>wlan_id</i> command to check whether the configuration takes effect. |
| AP | <pre>Ruijie#show running-config begin wlansec 1 wlansec 1 security wpa enable security wpa ciphers aes enable security wpa akm psk enable security wpa akm psk set-key ascii 12345678 !</pre> |

Common Errors

- The WLAN has been enabled with other encryption and authentication modes (such as WEP).
- A WPA encryption mode is configured before WPA authentication is enabled in WLAN security configuration mode.
- An access authentication mode is configured before WPA authentication is enabled in WLAN security configuration mode.
- If an access authentication mode is enabled in WLAN security configuration mode, no other access authentication mode can be configured.
- A WPA PSK key is configured before WPA authentication is enabled.
- The ASCII key consists of less than 8 characters or more than 63 characters.
- The hexadecimal key does not consist of 64 characters.

1.4.3 Configuring RSN Authentication

Configuration Effect

- Enable RSN authentication for a WLAN.
- Specify the access authentication mode and encryption mode in RSN authentication.

Notes

- When RSN authentication is used, the encryption mode and access authentication mode must also be configured.
- If the access authentication mode is set to PSK, a PSK key must be configured.
- In the security mode of a WLAN, RSN authentication cannot be configured with WEP authentication.

Configuration Steps

▾ Configuring RSN Authentication

- Mandatory.
- Enable RSN authentication in WLAN security configuration mode on the AP.

| | |
|---------------------|--|
| Command | security rsn { enable disable } |
| Parameter | enable: Enables RSN authentication. |
| Description | disable: Disables RSN authentication. |
| Defaults | RSN authentication is disabled by default. |
| Command Mode | WLAN security configuration mode |
| Usage Guide | The encryption mode and access authentication mode can be configured in RSN authentication only after RSN authentication is enabled; otherwise, the configuration does not take effect. When RSN authentication is used, the encryption mode and access authentication mode must also be configured. If either the encryption mode or the access authentication mode is configured or neither of them is configured, STAs cannot access a WLAN. |

▾ Configuring the Encryption Mode for RSN Authentication

- Mandatory.
- It is configured in WLAN security configuration mode on the AP.
- The encryption mode in RSN authentication can be configured only after RSN authentication is enabled. The AES and TKIP encryption modes can be enabled at the same time in WLAN security configuration mode. After an encryption mode is configured for a WLAN, communication data between an STA and the WLAN is protected by the corresponding encryption mode.

| | |
|---------------------|---|
| Command | security rsn ciphers { aes tkip } { enable disable } |
| Parameter | aes: Configures the AES encryption mode. |
| Description | tkip: Configures the TKIP encryption mode. enable: Enables the encryption mode for RSN authentication. disable: Disables the encryption mode for RSN authentication. |
| Defaults | No encryption mode is configured by default. |
| Command Mode | WLAN security configuration mode |
| Usage Guide | This command is used to enable an encryption mode for RSN authentication, which can be AES or TKIP. The AES and TKIP encryption modes can be enabled at the same time in WLAN security configuration mode. |

▾ Configuring the Access Authentication Mode for RSN Authentication

- Mandatory.

- It is configured in WLAN security configuration mode on the AP.
- The access authentication mode in RSN authentication can be configured only after RSN authentication is enabled. Only one access authentication mode can be enabled for a WLAN in security configuration mode. An STA can access a WLAN that is enabled with access authentication only after passing the access authentication.

| | |
|---------------------|--|
| Command | security rsn akm { psk 802.1x } { enable disable } |
| Parameter | psk: Sets the access authentication mode to pre-shared key authentication. |
| Description | 802.1x: Sets the access authentication mode to 802.1X authentication. enable: Enables the access authentication mode for RSN authentication. disable: Disables the access authentication mode for RSN authentication. |
| Defaults | No access authentication mode is configured by default. |
| Command Mode | WLAN security configuration mode |
| Usage Guide | The access authentication mode can be configured only after RSN authentication is enabled. Only one access authentication mode can be enabled for a WLAN in security configuration mode. |

📌 Configuring a Shared Key for RSN Authentication

- (Optional) It must be configured when RSN PSK authentication is enabled.
- It is configured in WLAN security configuration mode on the AP.

| | |
|---------------------|--|
| Command | security rsn akm psk set-key { ascii <i>ascii-key</i> hex <i>hex-key</i> } |
| Parameter | ascii: Specifies that the PSK key is ASCII code. |
| Description | ascii-key: Specifies a key in the ASCII format, consisting of 8 to 63 ASCII characters. hex: Specifies that the PSK key is hexadecimal code. hex-key: Specifies a key in the hexadecimal format, consisting of 64 characters. |
| Defaults | N/A |
| Command Mode | WLAN security configuration mode |
| Usage Guide | This shared key takes effect only when PSK authentication is enabled. A key in the ASCII format consists of 8 to 63 characters. A key in the hexadecimal format consists of 64 characters. |

Verification

Run the **show running-config | begin wlansec wlan_id** command to check whether the configuration takes effect.

Configuration Example

📌 Configuring RSN PSK Authentication, AES Encryption and Key 12345678 for WLAN 1

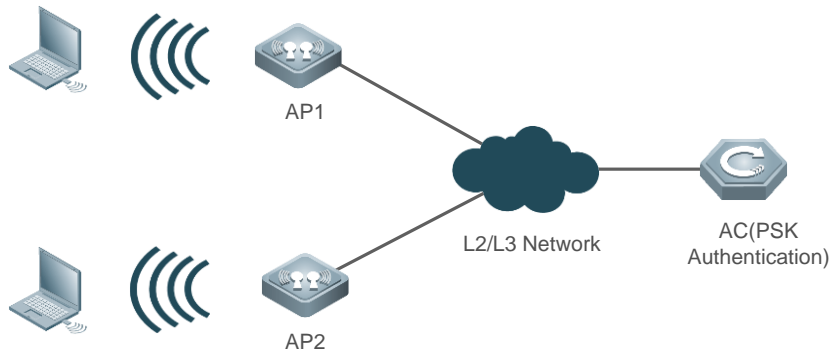
| | |
|--|--|
| <p>Scenario Figure 1-8</p> |  <p>In Fat AP mode, configure the security policies of WLAN 1 on AP1 and AP2 as follows:</p> <ol style="list-style-type: none"> 1. Configure RSN PSK authentication. 2. Configure the AES encryption mode. 3. Configure the shared key to 12345678. |
| <p>Configuration Steps</p> | <ul style="list-style-type: none"> ● Access security configuration mode of WLAN 1. ● Enable RSN authentication. ● Configure the AES encryption mode for RSN authentication. ● Configure the PSK access authentication mode for RSN authentication. ● Configure the PSK key 12345678. |
| <p>AP</p> | <pre>Ruijie(config)#wlansec 1 Ruijie(config-wlansec)#security rsn enable Ruijie(config-wlansec)#security rsn ciphers aes enable Ruijie(config-wlansec)#security rsn akm psk enable Ruijie(config-wlansec)#security rsn akm psk set-key ascii 12345678</pre> |
| <p>Verification</p> | <p>Run the show running-config begin wlansec <i>wlan_id</i> command to check whether the configuration takes effect.</p> |
| <p>AP</p> | <pre>Ruijie#show running-config begin wlansec 1 wlansec 1 security rsn enable security rsn ciphers aes enable security rsn akm psk enable security rsn akm psk set-key ascii 12345678 !</pre> |

Common Errors

- The WLAN has been enabled with other encryption and authentication modes (such as WEP).
- An RSN encryption mode is configured before RSN authentication is enabled in WLAN security configuration mode.
- An access authentication mode is configured before RSN authentication is enabled in WLAN security configuration mode.
- If an access authentication mode is enabled in WLAN security configuration mode, no other access authentication mode can be configured.
- An RSN PSK key is configured before RSN authentication is enabled.
- The ASCII key consists of less than 8 characters or more than 63 characters.
- The hexadecimal key does not consist of 64 characters.

1.4.4 Configuring MAB Authentication

Configuration Effect

- Enable MAB authentication for a WLAN.

Notes

- In security mode of a WLAN, MAB authentication cannot be configured together with 802.1X access authentication or WEP authentication, but can be configured together with PSK authentication.

Configuration Steps

▾ Configuring MAB Authentication

- Mandatory.
- Enable MAB authentication in WLAN security configuration mode on the AP.
- Run the **dot1x-mab** command to enable MAB authentication or run the **no dot1x-mab** command to disable MAB authentication.
- MAB authentication can be configured independently, without RSN or WPA authentication enabled. MAB authentication can be used together with PSK access authentication, but cannot be used together with 802.1X access authentication.

| | |
|---------------------|---|
| Command | dot1x-mab |
| Parameter | no: Disables MAB authentication. |
| Description | |
| Defaults | MAB authentication is not configured by default. |
| Command Mode | WLAN security configuration mode |
| Usage Guide | This command is used to enable MAB authentication. MAB authentication can be used together with PSK access authentication, but cannot be used together with 802.1X access authentication. |

Verification

Run the **show running-config | begin wlansec wlan_id** command to check whether the configuration takes effect.

Configuration Example

Configuring MAB Authentication for WLAN 1

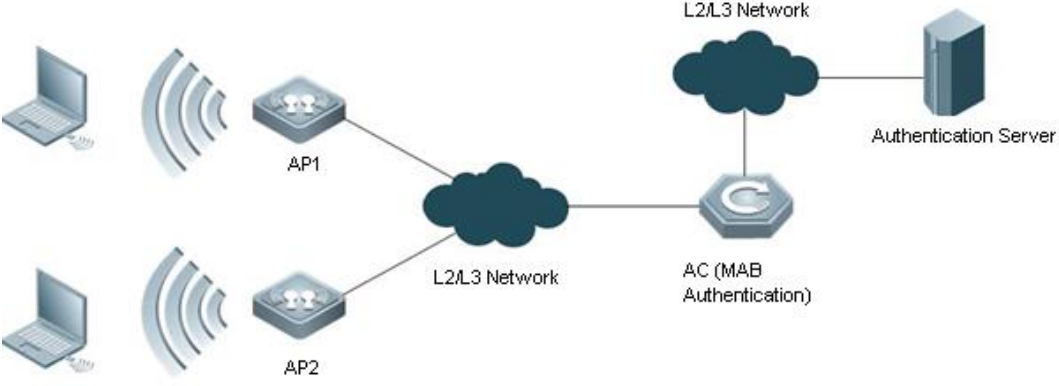
| | |
|---------------------------------------|---|
| <p>Scenario Figure 1-9</p> |  <p>In Fat AP mode, configure the security policies of WLAN 1 on AP1 and AP2 as follows:</p> <ol style="list-style-type: none"> 1. Configure MAB authentication. |
| <p>Configuration Steps</p> | <ul style="list-style-type: none"> ● Access the security configuration mode of WLAN 1. ● Enable MAB authentication. |
| <p>AP</p> | <pre>Ruijie(config)#wlansec 1 Ruijie(config-wlansec)#dot1x-mab</pre> |
| <p>Verification</p> | <p>Run the show running-config begin wlansec wlan_id command to check whether the configuration takes effect.</p> |
| <p>AP</p> | <pre>Ruijie#show running-config begin wlansec 1 wlansec 1 dot1x-mab !</pre> |

Common Errors

- The WLAN has been enabled with other encryption and authentication modes (such as WEP).
- If 802.1X access authentication is enabled in WLAN security configuration mode, MAB authentication cannot be configured.

1.4.5 Configuring Authentication Parameters

Configuration Effect

- Configure key interaction parameters.
- Configure the jitter prevention time in Web authentication.

Notes

- Key interaction parameters take effect only in PSK or 802.1X authentication.
- The jitter prevention time in Web authentication can be configured only after Web authentication is enabled.

Configuration Steps

▾ Configuring Key Interaction Parameters

- Optional. Generally, it is unnecessary to configure key interaction parameters. It is recommended to set the packet re-transmission count and timeout duration to great values for a poor WLAN environment.
- It is configured in WLAN security configuration mode on the AP.

| | |
|------------------------------|--|
| Command | authtimeout { forbidcount <i>count</i> forbidtime <i>time</i> groupcount <i>count</i> grouptime <i>timeout</i> paircount <i>count</i> pairtime <i>timeout</i> } |
| Parameter Description | <p>forbidcount <i>count</i>: Configures the association forbidding count after four-way handshake key interaction fails.</p> <p>forbidtime <i>time</i>: Configures the association forbidding interval after four-way handshake key interaction fails.</p> <p>groupcount <i>count</i>: Configures the multicast key negotiation packet re-transmission count.</p> <p>grouptime <i>timeout</i>: Configures the timeout duration of multicast key negotiation packets.</p> <p>paircount <i>count</i>: Configures the unicast key negotiation packet re-transmission count.</p> <p>pairtime <i>timeout</i>: Configures the timeout duration of unicast key negotiation packets.</p> |
| Defaults | <p>The association is not forbidden after four-way handshake key interaction fails.</p> <p>The default multicast key negotiation packet re-transmission count is 4.</p> <p>The default timeout duration of multicast key negotiation packets is 1200 ms.</p> <p>The default unicast key negotiation packet re-transmission count is 4.</p> <p>The default timeout duration of unicast key negotiation packets is 1200 ms.</p> |
| Command Mode | WLAN security configuration mode |
| Usage Guide | Key interaction parameters take effect only in PSK or 802.1X authentication. |

▾ Configuring the Jitter Prevention Time of Web Authentication

- Optional. The default jitter prevention time of Web authentication is 300 seconds. Users can configure the jitter prevention time based on actual requirements or disable the jitter prevention of Web authentication by setting the time to 0 seconds.
- It is configured in WLAN security configuration mode on the AP.

| | |
|---------------------|--|
| Command | <code>webauth prevent-jitter timeout</code> |
| Parameter | <i>timeout</i> : Configures the jitter prevention time of Web authentication, ranging from 0 to 86400 seconds (the jitter prevention of Web authentication is disabled when this parameter is set to 0). |
| Description | |
| Defaults | The default jitter prevention time of Web authentication is 300 seconds. |
| Command Mode | WLAN security configuration mode |
| Usage Guide | The jitter prevention time of Web authentication can be configured only after Web authentication is enabled. |

Verification

Run the `show running-config | begin wlansec wlan_id` command to check whether the configuration takes effect.

Configuration Example

Configuring the RSN-PSK + Web Authentication Mode, the Unicast Key Negotiation Re-transmission Count to 5, and the Jitter Prevention Time of Web Authentication to 900 Seconds for WLAN 1

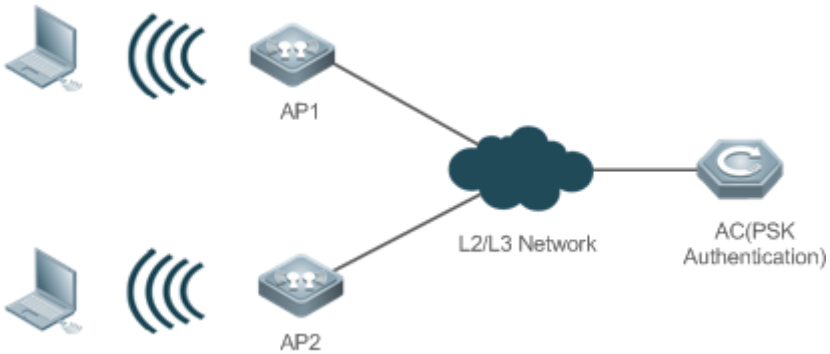
| | |
|--|--|
| <p>Scenario Figure 1-10</p> |  <p>In Fat AP mode, configure the security policies of WLAN 1 on AP1 and AP2 as follows:</p> <ol style="list-style-type: none"> 1. Configure RSN PSK authentication. 2. Enable Web authentication. |
| <p>Configuration Steps</p> | <ul style="list-style-type: none"> ● Access the security configuration mode of WLAN 1. ● Enable RSN authentication. ● Configure the AES encryption mode for RSN authentication. ● Configure the PSK access authentication mode for RSN authentication. ● Configure the PSK key 12345678. ● Set the unicast key negotiation packet re-transmission count to 5. ● Configure Web authentication. ● Set the jitter prevention time of Web authentication to 900 seconds. |
| <p>AP</p> | <pre>Ruijie(config)#wlansec 1 Ruijie(config-wlansec)#security rsn enable Ruijie(config-wlansec)#security rsn ciphers aes enable Ruijie(config-wlansec)#security rsn akm psk enable</pre> |

| | |
|---------------------|--|
| | <pre>Ruijie(config-wlansec)#security rsn akm psk set-key ascii 12345678 Ruijie(config-wlansec)#authtimeout paircount 5 Ruijie(config-wlansec)#webauth Ruijie(config-wlansec)#webauth prevent-jitter 900</pre> |
| Verification | Run the show running-config begin wlansec <i>wlan_id</i> command to check whether the configuration takes effect. |
| AP | <pre>Ruijie#show running-config begin wlansec 1 wlansec 1 security rsn enable security rsn ciphers aes enable security rsn akm psk enable security rsn akm psk set-key ascii 12345678 webauth prevent-jitter 900 webauth authtimeout paircount 5</pre> |

Common Errors

- The jitter prevention time of Web authentication is configured before Web authentication is enabled.

1.5 Monitoring

Displaying

| Description | Command |
|--|---|
| Displays security configuration of a WLAN. | show wlan security <i>wlan-id</i> |
| Displays security configuration of an STA. | show wclient security <i>mac-address</i> |

2 Configuring CPU Protect Policy

2.1 Overview

CPU Protect Policy (CPP) is a CPU protection policy.

Malicious attacks are often found in network environment. Network devices are occupied with counterfeited management and protocol packets and have no time to process real management and protocol packets. In this way, the attacks bring destructive impacts on device security and network stability. The CPP function protects CPU resources and important packets by means of packet identification and rate limiting.

Protocols and Standards

N/A

2.2 Applications

N/A

2.3 Features

Figure 2-1 Working Principle

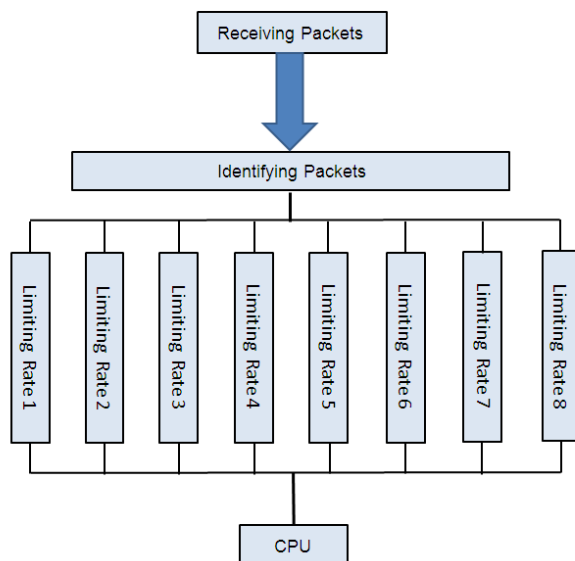

Basic Concepts

↳ Identifying Packets

All packets that are sent to the AP for protocol processing must be classified (e.g., into ARP, BPDU and d1x) through packet identification (for the data classification of different products, see Configuration).

Limiting Rate

An administrator can configure the rate limit for packets of each type, thus effectively dampening high-rate attack packets on the network.

Overview

| Feature | Description |
|-------------------------------------|--|
| Identifying Packets | All packets that are sent to CPU are classified through packet identification. |
| Limiting Rate | High-rate attack packets are dampened by rate limiting. |

2.3.1 Identifying Packets

All packets that are sent to CPU are classified through packet identification.

Working Principle

Identifying Packets

CPP classifies packets and automatically applies the packet identification function by default.

2.3.2 Limiting Rate

An administrator can configure the rate limit for packets of each type, thus effectively dampening high-rate attack packets on the network.

Working Principle

Limiting Rate

Packets that have been identified and classified are rate-limited, and packets that exceed the rate limit are discarded.

2.4 Configuration

| Configuration | Description and Command |
|--|--|
| Configuring the Rate Limit for Specified Packets |  (Optional) It is used to set the rate limit for specified packets. |
| | <code>cpu-protect type</code> Sets the rate limit for specified packets |

2.4.1 Configuring the Rate Limit for Specified Packets

Configuration Effect

- Configure the rate limit for various types of packets.

Notes

N/A

Configuration Steps

📌 Configuring the Rate limit for Specified Packets

- Optional.
- Enable the CPP function on all APs unless otherwise specified.
- A user can adjust the default rate limit for packets of each type according to actual requirements.

| | |
|------------------------------|--|
| Command | <code>cpu-protect type { arp bpdu capwap-disc d1x dhcp-option82 dhcp-relay-client dhcp-relay-server dhcps igmp ipmc ipv6-nans isis lldp ospf ospfv3 pim pppoe rip ripng tcp80 tcp443 vrrp } pps value</code> |
| Parameter Description | <p>arp: Specifies the ARP packet.</p> <p>bpdu: Specifies the IEEE BPDU packet.</p> <p>capwap-disc: Specifies the CAPWAP DISCOVER packet.</p> <p>d1x: Specifies the 802.1x EAPOL packet.</p> <p>dhcp-option82: Specifies the DHCP OPTION82 packet.</p> <p>dhcp-relay-client: Specifies the DHCP RELAY CLIENT packet.</p> <p>dhcp-relay-server: Specifies the DHCP RELAY SERVER packet.</p> <p>dhcps: Specifies the DHCP SNOOPING packet.</p> <p>igmp: Specifies the IGMP packet.</p> <p>ipmc: Specifies the IPv4 multicast packet.</p> <p>ipv6-nans: Specifies the IPv6 neighbor discovery packet.</p> <p>isis: Specifies the ISIS packet.</p> <p>lldp: Specifies the LLDP packet.</p> <p>ospf: Specifies the OSPF packet.</p> <p>ospfv3: Specifies the OSPF version3 packet.</p> <p>pppoe: Specifies the PPPOE packet.</p> <p>pim: Specifies the PIM packet.</p> <p>rip: Specifies the IPv4 RIP packet.</p> <p>ripng: Specifies the IPv6 RIP packet.</p> <p>tcp80: Specifies the Web authentication redirection packet.</p> <p>tcp443: Specifies the HTTPS packet.</p> <p>vrrp: Specifies the VRRP packet.</p> <p>pps value: Specifies the upper limit of packets per second, ranging from 0 to 148,810pps.</p> |
| Defaults | The default values vary with the product model. |
| Command Mode | Global configuration mode |
| Usage Guide | N/A |

Verification

- Run the **show cpu-protect summary** command to display the configuration.

Configuration Example

N/A

Common Errors

N/A

2.5 Monitoring

Displaying

| Description | Command |
|---|---|
| Displays the rate limit for packets of various types. | show cpu-protect summary |
| Displays statistics about specified packets. | show cpu-protect type { arp bpdu capwap-disc d1x dhcp-option82 dhcp-relay-client dhcp-realy-server dhcps igmp ipmc ipv6-nans isis lldp ospf ospfv3 pim pppoe rip ripng tcp80 tcp443 vrrp } |

3 Configuring NFPP

3.1 Overview

The Network Foundation Protection Policy (NFPP) provides guard for switches.

Some malicious attacks are always found in the network environment. These attacks bring heavy burdens to switches, resulting in high CPU usage and abnormal running on switches. These attacks are as follows:

Denial of service (DoS) attacks may greatly consume the memory, entries, or other resources of a switch to cause system service unavailable.

Massive packet traffic is directed to the CPU, occupying the entire bandwidth of packets sent to the CPU. In this case, normal protocol traffic and management traffic cannot be processed by the CPU, causing protocol flapping or management failure. The forwarding on the data plane will also be affected and the entire network will become abnormal.

A great number of packets directed to the CPU consume massive CPU resources, making the CPU highly loaded and thereby causing device management failure or causing abnormal running.

NFPP can effectively protect the system from these attacks. Under attacks, NFPP protects proper running of various system services and keeps a low CPU load, thereby ensuring stable running of the entire network.

3.2 Applications

| Application | Description |
|--|---|
| Attack Detection and Rate Limiting | Due to various malicious attacks such as ARP attacks and IP scanning attacks in the network, the CPU cannot process normal protocol and management traffic, causing protocol flapping or management failure. The NFPP attack detection and rate limiting function is used to limit the rate of attack traffic or isolate attack traffic so that the network can be recovered. |
| Centralized Rate Limiting and Distribution | Since normal service traffic is too large, you need to classify and prioritize the traffic. When a large number of packets are directed to the CPU, the CPU will be highly loaded, thereby causing device management or device running failure. The centralized rate limiting and distribution function is used to increase the priority of such traffic so that switches can run stably. |

3.2.1 Attack Detection and Rate Limiting

Scenario

NFPP supports attack detection and rate limiting for various types of packets, including Address Resolution Protocol (ARP), Internet Control Message Protocol (ICMP), and Dynamic Host Configuration Protocol (DHCP) packets. It also allows users to define packet matching characteristics and corresponding attack detection and rate limiting policies. The attack detection and

rate limiting function takes effect based on each type of packets. This section uses ARP packets as an example to describe the scenario.

If an attacker sends ARP attack packets while the CPU capability is insufficient, a large number of CPU resources will be consumed for processing these ARP packets. If the attacker's ARP packet rate exceeds the maximum ARP bandwidth specified in the CPU Protect Policy (CPP) of the switch, packet loss occurs among normal ARP packets. As shown in Figure 3-1, common users will fail to access the network, and the switch will fail to send ARP responses to other devices.

Figure 3-1

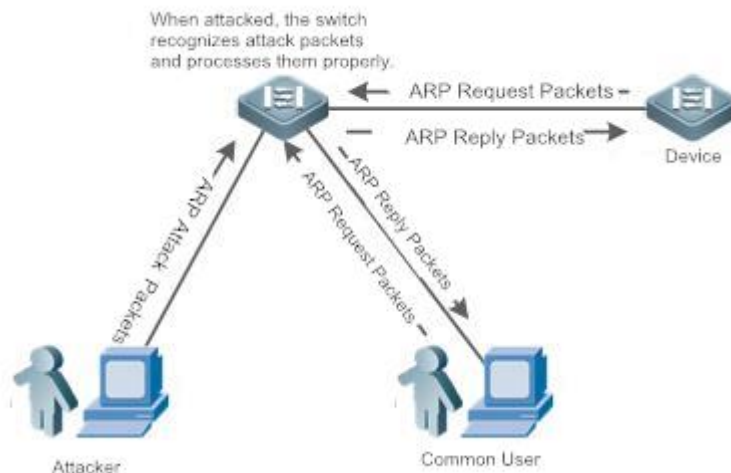

Deployment

- By default, the ARP attack detection and rate limiting function is enabled, with corresponding policies configured. If an attacker's ARP packet rate exceeds the rate limit, the packets will be discarded. If the packet rate exceeds the attack threshold, a monitored host will be generated and prompt information will be output.
- If an attacker's ARP packet rate exceeds the rate limit defined in the CPP and affects normal ARP responses, you can enable attack isolation to discard ARP attack packets based on an ACL and recover the network.

i For description of CPP configurations, refer to the "CPP" section.

i To maximize the use of NFPP guard functions, modify the rate limits for various services in the CPP based on the application environment or use the configurations recommended by the system. You can run the **show cpu-protect summary** command to display the configurations.

3.2.2 Centralized Rate Limiting and Distribution

Scenario

A switch classifies services defined in the CPP into three types: Manage, Route, and Protocol. Each type of services has an independent bandwidth. Different types of services cannot share their bandwidths. Traffic exceeding the bandwidth threshold is discarded. By such service classification, service packets of a certain type can be processed first.

As shown in Figure 3-2, the switch receives a large number of Telnet packets, OSPF packets, and ARP packets, causing CPU overload. In this case, the CPU cannot process all packets, and a large number of packets are backlogged in the queue, causing various problems such as occasional Telnet disconnection, OSPF protocol flapping, and ARP access failure to hosts.

Figure 3-2

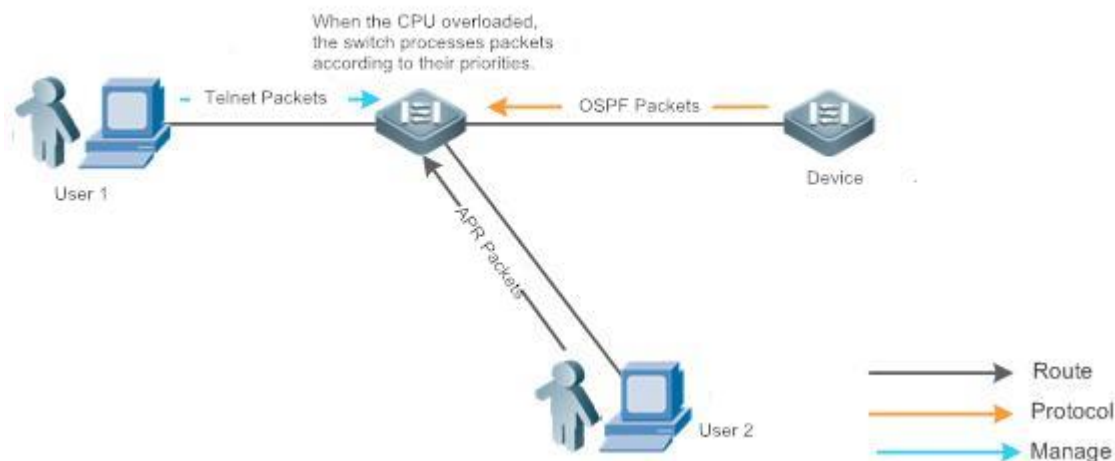

Deployment

- By default, CPU centralized protection is enabled to assign an independent bandwidth and bandwidth ratio to each type of services. At the time, the CPU first processes Telnet packets to ensure uninterrupted connection of the Telnet service, and then processes OSPF packets to maintain OSPF protocol stability, and finally processes ARP packets.
- If the preceding problems occur in default configurations, you can accordingly adjust the bandwidth and bandwidth ratio for various types of services.

3.3 Features

Basic Concepts

ARP Guard

In local area networks (LANs), IP addresses are converted to MAC addresses through ARP, which is significant for safeguarding network security. A large number of illegal ARP packets are sent to the gateway through the network, causing failure of the gateway to provide services for normal hosts. Such packets are called ARP-based DoS attacks. To prevent such attacks, limit the rate of ARP packets and detect and isolate the attack source.

IP Anti-scanning

Many hacker attacks and network virus intrusions start from scanning active hosts in the network. Therefore, many scanning packets rapidly occupy the network bandwidth, causing network communication failure.

To solve this problem, Layer-3 switches provide IP guard to prevent scanning by hackers and Blaster Worm viruses and reduce the CPU load. Currently, there are mainly two types of IP attacks:

- Scanning destination IP address changes: As the greatest threat to the network, this type of attacks not only consumes network bandwidth and increases device load but also is a prelude of most hacker attacks.
- Sending IP packets to non-existing destination IP addresses at high rates: This type of attacks is mainly designed for consuming the CPU load. For a Layer-3 device, if the destination IP address exists, packets are directly forwarded by the switching chip without occupying CPU resources. If the destination IP address does not exist, IP packets are sent to the CPU, which then sends ARP requests to query the MAC address corresponding to the destination IP address. If too many packets are sent to the CPU, CPU resources will be consumed. This type of attacks is less destructive than the former ones.

To prevent the latter type of attacks, limit the rate of IP packets and detect and isolate the attack source.

📌 ICMP Guard

ICMP is a common approach for diagnosing network failures. After receiving an ICMP echo request from a host, the router or switch returns an ICMP echo reply. The preceding process requires the CPU to process the packets, thereby definitely consuming part of CPU resources. If an attacker sends a large number of ICMP echo requests to the destination device, massive CPU resources will be consumed on the device, and the device may even fail to work properly. This type of attacks is called ICMP flood. To prevent this type of attacks, limit the rate of ICMP packets and detect and isolate the attack source.

📌 DHCP Guard

DHCP is widely used in LANs to dynamically assign IP addresses. It is significant for network security. Currently, the most common DHCP attacks, also called DHCP exhaustion attacks, use faked MAC addresses to broadcast DHCP requests. Various attack tools on the live network can easily complete this type of attacks. A network attacker can send sufficient DHCP requests to use up the address space provided by the DHCP server within a period. In this case, authorized hosts will fail to request DHCP IP addresses and thereby fail to access the network. To prevent this type of attacks, limit the rate of DHCP packets and detect and isolate the attack source.

📌 DHCPv6 Guard

DHCP version 6 (DHCPv6) is widely used in LANs to dynamically assign IPv6 addresses. Both DHCP version 4 (DHCPv4) and DHCPv6 have security problems. Attacks to DHCPv4 also apply to DHCPv6. A network attacker can send a large number of DHCPv6 requests to use up the address space provided by the DHCPv6 server within a period. In this case, authorized hosts will fail to request IPv6 addresses and therefore fail to access the network. To prevent this type of attacks, limit the rate of DHCPv6 packets and detect and isolate the attack source.

📌 ND Guard

Neighbor Discovery (ND) is mainly used in IPv6 networks to perform address resolution, router discovery, prefix discovery, and redirection. ND uses five types of packets: Neighbor Solicitation (NS), Neighbor Advertisement (NA), Router Solicitation (RS), Router Advertisement (RA), and Redirect. These packets are called ND packets.

ND snooping monitors ND packets in the network to filter unauthorized ND packets. It also monitors IPv6 hosts in the network and binds the monitored IPv6 hosts to ports to prevent IPv6 address stealing. ND snooping requires ND packets to

be sent to the CPU. If ND packets are sent at a very high rate, the CPU will be attacked. Therefore, ND guard must be provided to limit the rate of ND packets.

Overview

| Feature | Description |
|--|---|
| Host-based Rate Limiting and Attack Identification | Limit the rate according to the host-based rate limit and identify host attacks in the network. |
| Port-based Rate Limiting and Attack Identification | Limit the rate according to the port-based rate limit and identify port attacks. |
| Configuring the Monitoring Period | Monitor host attackers in a specified period. |
| Configuring the Isolation Period | Isolate host attackers or port attackers in a specified period. |
| Configuring Trusted Hosts | Trust a host by not monitoring it. |
| Centralized Rate Limiting and Distribution | Classify and prioritize packets. |

3.3.1 Host-based Rate Limiting and Attack Identification

Limit the rate of attack packets of hosts and identify the attacks.

Identify ARP scanning.

Identify IP scanning.

Working Principle

Hosts can be identified in two ways: based on the source IP address, VLAN ID, and port and based on the link-layer source MAC address, VLAN ID, and port. Each host has a rate limit and an attack threshold (also called alarm threshold). The rate limit must be lower than the attack threshold. If the attack packet rate exceeds the rate limit of a host, the host discards the packets beyond the rate limit. If the attack packet rate exceeds the attack threshold of a host, the host identifies host attacks, records them in logs, and sends Trap packets.

ARP scanning attacks may have occurred if ARP packets beyond the scanning threshold received in the configured period meet either of the following conditions:

- The link-layer source MAC address is fixed but the source IP address changes.
- The link-layer source MAC address and source IP address are fixed but the destination IP address continuously changes.

Among IP packets beyond the scanning threshold received in the configured period, if the source IP address remains the same while the destination IP address continuously changes, IP scanning attack may have occurred.

 When NFPP detects a specific type of attack packets under a service, it sends an alarm to the administrator. If the attack traffic persists, NFPP will not resend the alarm within 60 seconds after generating an alarm.

-
- i** To prevent CPU resource consumption caused by frequent log printing, NFPP writes attack detection logs to the buffer, obtains them from the buffer at a specified rate, and prints them. NFPP does not limit the rate of Trap packets.
 - i** At present, only ARP guard and IP anti-scanning support anti-scanning.
-

3.3.2 Port-based Rate Limiting and Attack Identification

Limit the rate of port-based attack packets and identify the attacks.

Working Principle

Each port has a rate limit and an attack threshold. The rate limit must be lower than the attack threshold. If the packet rate exceeds the rate limit on a port, the port discards the packets. If the packet rate exceeds the attack threshold on a port, the port records the attacks in logs and sends Trap packets.

3.3.3 Configuring the Monitoring Period

Configures the monitoring period for an attacker.

Working Principle

Monitored hosts provide information about attackers in the current system. If the isolation period is 0 (that is, no isolation), the guard module automatically performs software monitoring on attackers in the configured monitoring period. Within the monitoring period, you can view the entries of a monitored host. If attacks are received from this host before aging of the monitoring period, refresh the monitoring period of the host; otherwise, when the monitoring period is aged to 0, the entries of the monitored host will be deleted. When the isolation time is configured to a non-0 value, the guard module automatically isolates the host monitored by the software.

3.3.4 Configuring the Isolation Period

Configure the isolation period for an attacker.

Working Principle

Isolation is performed by the guard policy after attacks are detected. Isolation is implemented using the filtering function of a software ACL to ensure that these attacks are not sent to the CPU, thereby ensuring proper running of the device.

The isolation function supports host-based and port-based isolation. When an attacker is isolated, a policy will be configured into an ACL. When the ACL resources are exhausted and isolation fails, logs will be printed to remind the administrator.

3.3.5 Configuring Trusted Hosts

Configure trusted hosts.

Working Principle

If you do not want to monitor a host, you can run the following commands to configure the host to be trusted. This trusted host will be allowed to send packets of specified types to the CPU.

3.3.6 Centralized Rate Limiting and Distribution

Set the rate thresholds and percentages for Manage, Route and Protocol packets.

Working Principle

Services defined in the CPP are classified into three types: Manage, Route, and Protocol. (For details, see the following table.) Each type of services has an independent bandwidth. Different types of services cannot share their bandwidths. Traffic exceeding the bandwidth threshold is discarded. By such service classification, service packets of a certain type can be processed first.

NFPP allows the administrator to flexibly assign bandwidth for three types of packets based on the actual network environment so that Protocol and Manage packets can be first processed. Prior processing of Protocol packets ensures proper running of the protocol, and prior processing of Manage packets helps the administrator perform proper management, thereby ensuring proper running of important device functions and improving the guard capability of the device.





After rate limiting for the preceding packet types, all types of packets are centralized in a queue. When one type of service features a lower processing efficiency, packets of this service will be backlogged in the queue and may finally use up resources of the queue. NFPP allows the administrator to configure the percentages of these three types of packets in the queue. When the queue length occupied by one type of packets exceeds the product of the total queue length and the percentage of this type of packets, these packets are discarded. This effectively prevents one type of packets from exclusively occupying queue resources.





| Packet Type | Service Type Defined in the CPP |
|-------------|--|
| Protocol | tp-guard, dot1x, rldp, rerp, slow-packet, bpdu, isis dhcps, gvrp, ripng, dvmrp, igmp, mpls, ospf, pim, pimv6, rip, vrrp, ospf3, dhcp-relay-s, dhcp-relay-c, option82, tunnel-bpdu, and tunnel-gvrp |
| Route | unknown-ipmc, unknown-ipmcv6, ttl1, ttl0, udp-helper, ip4-packet-other, ip6-packet-other, and non-ip-packet-other |
| Manage | ip4-packet-local, ip6-packet-local, and arp |





 For the definitions of service types, see the *CPP Configuration Guide*.

3.4 Configuration

| Configuration | Description and Command | |
|---------------------------------------|--|--|
| Configuring ARP Guard |  (Mandatory) It is used to configure the global ARP guard function. | |
| | arp-guard enable | Enables global attack detection. |
| | arp-guard monitor-period | Configures the monitoring period. |
| | arp-guard monitored-host-limit | Configures the maximum number of monitored hosts. |
| | arp-guard rate-limit | Configures the global rate limit. |
| | arp-guard attack-threshold | Configures the global attack threshold. |
| | arp-guard scan-threshold | Configures the global host-based scanning threshold. |

| Configuration | Description and Command | |
|--|--|--|
| |  (Optional) It is used to configure ARP isolation and ARP guard. | |
| | arp-guard isolate-period | Configures the global isolation period. |
| | arp-guard trusted-host | Configures trusted hosts. |
| | nfpp arp-guard enable | Enables attack detection for a port. |
| | nfpp arp-guard policy | Configures the rate limit and attack threshold for a port. |
| | nfpp arp-guard scan-threshold | Configures the stage-by-stage scanning threshold for a port. |
| | nfpp arp-guard isolate-period | Configures the isolation period for a port. |
| Configuring IP Anti-scanning |  (Mandatory) It is used to configure the global IP anti-scanning function. | |
| | ip-guard enable | Enables global attack detection. |
| | ip-guard monitor-period | Configures the monitoring period. |
| | ip-guard monitored-host-limit | Configures the maximum number of monitored hosts. |
| | ip-guard rate-limit | Configures the global rate limit. |
| | ip-guard attack-threshold | Configures the global attack threshold. |
| | ip-guard scan-threshold | Configures the global host-based scanning threshold. |
| |  (Optional) It is used to configure IP trusted hosts, IP isolation and port-based IP anti-scanning. | |
| | ip-guard isolate-period | Configures the global isolation period. |
| | ip-guard trusted-host | Configures trusted hosts. |
| | nfpp ip-guard enable | Enables attack detection for a port. |
| | nfpp ip-guard policy | Configures the rate limit and attack threshold for a port. |
| | nfpp ip-guard scan-threshold | Configures the stage-by-stage scanning threshold for a port. |
| nfpp ip-guard isolate-period | Configures the isolation period for a port. | |
| Configuring ICMP Guard |  (Mandatory) It is used to configure the global ICMP guard function. | |
| | icmp-guard enable | Enables global attack detection. |
| | icmp-guard monitor-period | Configures the monitoring period. |
| | icmp-guard monitored-host-limit | Configures the maximum number of monitored hosts. |
| | icmp-guard rate-limit | Configures the global rate limit. |
| | icmp-guard attack-threshold | Configures the global attack threshold. |

| Configuration | Description and Command | |
|--|--|--|
| |  (Optional) It is used to configure ICMP trusted hosts, ICMP isolation and port-based ICMP guard. | |
| | icmp-guard isolate-period | Configures the global isolation period. |
| | icmp-guard trusted-host | Configures trusted hosts. |
| | nfpp icmp-guard enable | Enables attack detection for a port. |
| | nfpp icmp-guard policy | Configures the rate limit and attack threshold for a port. |
| | nfpp icmp-guard isolate-period | Configures the isolation period for a port. |
| Configuring DHCP Guard |  (Mandatory) It is used to configure the global DHCP guard function. | |
| | dhcp-guard enable | Enables global attack detection. |
| | dhcp-guard monitor-period | Configures the monitoring period. |
| | dhcp-guard monitored-host-limit | Configures the maximum number of monitored hosts. |
| | dhcp-guard rate-limit | Configures the global rate limit. |
| | dhcp-guard attack-threshold | Configures the global attack threshold. |
| |  (Optional) It is used to configure DHCP isolation and port-based DHCP guard. | |
| | dhcp-guard isolate-period | Configures the global isolation period. |
| | dhcp-guard trusted-host | Configures trusted hosts. |
| | nfpp dhcp-guard enable | Enables attack detection for a port. |
| | nfpp dhcp-guard policy | Configures the rate limit and attack threshold for a port. |
| nfpp dhcp-guard isolate-period | Configures the isolation period for a port. | |
| Configuring DHCPv6 Guard |  (Mandatory) It is used to configure the global DHCPv6 guard function. | |
| | dhcpv6-guard enable | Enables global attack detection. |
| | dhcpv6-guard monitor-period | Configures the monitoring period. |
| | dhcpv6-guard monitored-host-limit | Configures the maximum number of monitored hosts. |
| | dhcpv6-guard rate-limit | Configures the global rate limit. |
| | dhcpv6-guard attack-threshold | Configures the global attack threshold. |
| |  (Optional) It is used to configure DHCPv6 isolation and DHCPv6 guard. | |
| | dhcpv6-guard isolate-period | Configures the global isolation period. |
| | dhcpv6-guard trusted-host | Configures trusted hosts. |
| | nfpp dhcpv6-guard enable | Enables attack detection for a port. |
| | nfpp dhcpv6-guard policy | Configures the rate limit and attack threshold for a port. |
| nfpp dhcpv6-guard isolate-period | Configures the isolation period for a port. | |

| Configuration | Description and Command | |
|--|--|---|
| Configuring ND Guard |  (Mandatory) It is used to configure the global ND guard function. | |
| | nd-guard enable | Enables global attack detection. |
| | nd-guard rate-limit | Configures the global rate limit. |
| | nd-guard attack-threshold | Configures the global attack threshold. |
| |  (Optional) It is used to configure the port-based ND guard function. | |
| | nd-guard trusted-host | Configures trusted hosts. |
| | nfpp nd-guard enable | Enables attack detection for a port. |
| Configuring Centralized Rate Limiting and Distribution |  (Optional) It is used to set the rate thresholds and percentages for Manage, Route and Protocol packets. | |
| | cpu-protect sub-interface pps | Configures the maximum bandwidth for each type of packets. |
| | cpu-protect sub-interface percent | Configures the maximum percentage of each type of packets in the queue. |
| |  (Mandatory) It is used to set log information. | |
| Configuring NFPP Log Information | log-buffer entries | Configures the capacity of NFPP log buffer. |
| | log-buffer logs | Configures the rate when logs are obtained from the log buffer to generate system messages. |
| |  (Optional) It is used to set logs to be recorded. | |
| | logging vlan | Specifies the VLANs in which logs need to be recorded. |
| | logging interface | Specifies the port on which logs need to be recorded. |

3.4.1 Configuring ARP Guard

Configuration Effect

- ARP attacks are identified based on hosts or ports. Host-based ARP attack identification supports two modes: identification based on the source IP address, VLAN ID, and port and identification based on the link-layer source MAC address, VLAN ID, and port. Each type of attack identification has a rate limit and an alarm threshold. If the ARP packet rate exceeds the rate limit, the packets beyond the rate limit are discarded. If the ARP packet rate exceeds the alarm threshold, the system prints alarm information and sends Trap packets. In host-based attack identification, the system also isolates the attack source.

- ARP guard can also detect ARP scanning attacks. ARP scanning attacks indicate that the link-layer source MAC address is fixed but the source IP address changes, or that the link-layer source MAC address and source IP address are fixed but the destination IP address continuously changes. Due to the possibility of misjudgment, hosts possibly performing ARP scanning are not isolated and are provided for the administrator's reference only.

Notes

- For a command that is configured both in global configuration mode and interface configuration mode, the configuration in interface configuration mode takes priority over that configured in global configuration mode.
- Isolation is disabled by default. If isolation is enabled, attackers will occupy entries of the security module.
- ARP guard prevents only ARP DoS attacks to the switch, but not ARP spoofing or ARP attacks in the network.

Configuration Steps

↳ Enabling Attack Detection

- Mandatory.
- Support the global configuration mode or interface configuration mode on the AP device.
- If ARP guard is disabled, the system automatically clears monitored hosts, scanned hosts, and port isolation entries.

| | |
|---------------------|----------------------------------|
| Command | arp-guard enable |
| Parameter | N/A |
| Description | |
| Defaults | ARP guard is enabled by default. |
| Command Mode | NFPP configuration mode |
| Usage Guide | N/A |

| | |
|---------------------|--|
| Command | nfpp arp-guard enable |
| Parameter | N/A |
| Description | |
| Defaults | ARP guard is configured in global configuration mode, but not in interface configuration mode. |
| Command Mode | Interface configuration mode |
| Usage Guide | ARP guard configured in interface configuration mode takes priority over that configured in global configuration mode. |

↳ Configuring the Isolation Period

- (Optional) Isolation is disabled by default.
- If the packet traffic of attackers exceeds the rate limit, you can configure the isolation period to directly discard packets and therefore save bandwidth resources.
- Support the global configuration mode or interface configuration mode on the AP device.

- If the isolation period is changed to 0, attackers under the corresponding port is deleted, instead of being monitored by software.

| | |
|------------------------------|--|
| Command | arp-guard isolate-period [<i>seconds</i> permanent] |
| Parameter Description | <i>seconds</i> : Indicates the isolation period in the unit of second. It can be set to 0 or any value from 30 to 86,400. permanent : Indicates permanent isolation. |
| Defaults | The default global isolation period is 0, that is, no isolation. |
| Command Mode | NFPP configuration mode |
| Usage Guide | N/A |

| | |
|------------------------------|--|
| Command | nfpp arp-guard isolate-period [<i>seconds</i> permanent] |
| Parameter Description | <i>seconds</i> : Indicates the isolation period in the unit of second. It can be set to 0 or any value from 30 to 86,400. The value 0 indicates no isolation. permanent : Indicates permanent isolation. |
| Defaults | By default, a global isolation period is used, but no local isolation period is configured. |
| Command Mode | Interface configuration mode |
| Usage Guide | N/A |

↘ **Configuring the Monitoring Period**

- Mandatory.
- If the isolation period is configured, it is directly used as the attacker monitoring period, and the configured monitoring period does not take effect.
- Support the global configuration mode on the AP device.

| | |
|------------------------------|--|
| Command | arp-guard monitor-period <i>seconds</i> |
| Parameter Description | <i>seconds</i> : Indicates the monitoring period in the unit of second. The value ranges from 180 to 86,400. |
| Defaults | The default monitoring period is 600 seconds. |
| Command Mode | NFPP configuration mode |
| Usage Guide | N/A |

↘ **Configuring the Maximum Number of Monitored Hosts**

- Mandatory.
- Configure the maximum number of monitored hosts. As the number of actually monitored hosts increases, more CPU resources are used to handle monitored hosts.
- Support the global configuration mode on the AP device.

- If the number of monitored hosts exceeds 1000 (default value), the administrator can set the maximum number of monitored hosts to a value smaller than 1000. In this case, the system does not delete monitored hosts but prints the information "%ERROR: The value that you configured is smaller than current monitored hosts 1000, please clear a part of monitored hosts." This information notifies the administrator that the configuration does not take effect and that part of monitored hosts need to be deleted.
- If the table of monitored hosts is full, the system prints the log "% NFPP_ARP_GUARD-4-SESSION_LIMIT: Attempt to exceed limit of 1000 monitored hosts." to notify the administrator.

| | |
|---------------------|---|
| Command | arp-guard monitored-host-limit <i>number</i> |
| Parameter | <i>number</i> : Indicates the maximum number of monitored hosts, ranging from 1 to 4,294,967,295. |
| Description | |
| Defaults | The maximum number of monitored hosts is 1000 by default. |
| Command Mode | NFPP configuration mode |
| Usage Guide | N/A |

▾ Configuring the Attack Threshold

- Mandatory.
- To achieve the best ARP guard effect, you are advised to configure the host-based rate limit and alarm threshold based on the following rules: Source IP address-based rate limit < Source IP address-based alarm threshold < Source MAC address-based rate limit < Source MAC address-based alarm threshold.
- Support the global configuration mode or interface configuration mode on the AP device.
- If the configured rate limit is greater than the attack threshold, the system prints the log "%ERROR: rate limit is higher than attack threshold 500pps." to notify the administrator.
- If the configured attack threshold is smaller than the rate limit, the system prints the log "%ERROR: attack threshold is smaller than rate limit 300pps." to notify the administrator.
- If the memory cannot be allocated to detected attackers, the system prints the log "%NFPP_ARP_GUARD-4-NO_MEMORY: Failed to alloc memory." to notify the administrator.
- Source MAC address-based rate limiting takes priority over source IP address-based rate limiting while the latter takes priority over port-based rate limiting.
- In NFPP configuration mode: run the **arp-guard rate-limit {per-src-ip | per-src-mac} pps** command to configure rate limits of hosts identified based on the source IP address, VLAN ID, and port and of hosts identified based on the link-layer source MAC address, VLAN ID, and port.
- In NFPP configuration mode: run the **arp-guard attack-threshold {per-src-ip | per-src-mac} pps** command to configure attack thresholds of hosts identified based on the source IP address, VLAN ID, and port and of hosts identified based on the link-layer source MAC address, VLAN ID, and port.
- In interface configuration mode: run the **nfpp arp-guard policy {per-src-ip | per-src-mac} rate-limit-pps attack-threshold-pps** command to configure rate limits and attack thresholds of hosts identified based on the source IP

address, VLAN ID, and port and of hosts identified based on the link-layer source MAC address, VLAN ID, and port on an interface.

| | |
|------------------------------|--|
| Command | <code>arp-guard rate-limit { per-src-ip per-src-mac per-port } pps</code> |
| Parameter Description | <p>per-src-ip: Limits the rate for each source IP address.</p> <p>per-src-mac: Limits the rate of packets from each source MAC address.</p> <p>per-port: Limits the rate for each port.</p> <p><i>pps:</i> Indicates the rate limit, ranging from 1 to 9,999.</p> |
| Defaults | For AP devices, the default rate limit for packets based on source IP address/source MAC address is 30 pps, and the default rate limit for packets based on port is 240 pps. |
| Command Mode | NFPP configuration mode |
| Usage Guide | N/A |

| | |
|------------------------------|--|
| Command | <code>arp-guard attack-threshold { per-src-ip per-src-mac per-port } pps</code> |
| Parameter Description | <p>per-src-ip: Configures the attack threshold for each source IP address.</p> <p>per-src-mac: Configures the attack threshold for each source MAC address.</p> <p>per-port: Configures the attack threshold for each port.</p> <p><i>pps:</i> Indicates the attack threshold, ranging from 1 to 9,999. The unit is packets per second (pps).</p> |
| Defaults | For AP devices, the default rate limit for packets based on source IP address/source MAC address is 60 pps, and the default rate limit for packets based on port is 480 pps. |
| Command Mode | NFPP configuration mode |
| Usage Guide | The attack threshold must be equal to or greater than the rate limit. |

| | |
|------------------------------|---|
| Command | <code>nfpp arp-guard policy { per-src-ip per-src-mac per-port } rate-limit-pps attack-threshold-pps</code> |
| Parameter Description | <p>per-src-ip: Configures the rate limit and attack threshold for each source IP address.</p> <p>per-src-mac: Configures the rate limit and attack threshold for each source MAC address.</p> <p>per-port: Configures the rate limit and attack threshold for each port.</p> <p><i>rate-limit-pps:</i> Indicates the rate limit, ranging from 1 to 9,999.</p> <p><i>attack-threshold-pps:</i> Indicates the attack threshold, ranging from 1 to 9,999.</p> |
| Defaults | By default, no rate limit and attack thresholded are configured for a port, and the global rate limit and attack threshold are used. |
| Command Mode | Interface configuration mode |
| Usage Guide | The attack threshold must be equal to or greater than the rate limit. |

↘ Configuring the Scanning Threshold

- Mandatory.
- Support the global configuration mode or interface configuration mode on the AP device.

- The ARP scanning table stores only the latest 256 records. When the ARP scanning table is full, the latest record will overwrite the earliest record.
- ARP scanning attack may have occurred if ARP packets received within 10 seconds meet either of the following conditions:
 - The link-layer source MAC address is fixed but the source IP address changes.
 - The link-layer source MAC address and source IP address are fixed but the destination IP address continuously changes, and the change times exceed the scanning threshold.

| | |
|------------------------------|---|
| Command | arp-guard scan-threshold <i>pkt-cnt</i> |
| Parameter Description | <i>pkt-cnt</i> : Indicates the scanning threshold, ranging from 1 to 9,999. |
| Defaults | The default scanning threshold is 100 in the unit of 10 seconds. |
| Command Mode | NFPP configuration mode |
| Usage Guide | N/A |

| | |
|------------------------------|---|
| Command | nfpp arp-guard scan-threshold <i>pkt-cnt</i> |
| Parameter Description | <i>pkt-cnt</i> : Indicates the scanning threshold, ranging from 1 to 9,999. |
| Defaults | By default, no port-based ARP scanning threshold is configured and the global ARP scanning threshold is used. |
| Command Mode | Interface configuration mode |
| Usage Guide | N/A |

📌 Configuring Trusted Hosts

- (Optional) No trusted host is configured by default.
- For ARP guard, you can configure only a maximum of 500 IP addresses and MAC addresses not to be monitored.
- Support the global configuration mode on the AP device.
- If any entry matching a trusted host (the IP addresses and MAC addresses are the same) exists in the table of monitored hosts, the system automatically deletes this entry.
- If the table of trusted hosts is full, the system prints the log "%ERROR: Attempt to exceed limit of 500 trusted hosts." to notify the administrator.
- If the administrator fails to delete a trusted host, the system prints the log "%ERROR: Failed to delete trusted host 1.1.1.1 0000.0000.1111." to notify the administrator.
- If you fail to add a trusted host, the system prints the log "%ERROR: Failed to add trusted host 1.1.1.1 0000.0000.1111." to notify the administrator.
- If the trusted host you want to add already exists, the system prints the log "%ERROR: Trusted host 1.1.1.1 0000.0000.1111 has already been configured." to notify the administrator.

- If the trusted host you want to delete does not exist, the system prints the log "%ERROR: Trusted host 1.1.1.1 0000.0000.1111 is not found." to notify the administrator.

| | |
|---------------------|--|
| Command | arp-guard trusted-host <i>ip mac</i> |
| Parameter | <i>ip</i> : Indicates the IP address. |
| Description | <i>mac</i> : Indicates the MAC address. |
| Defaults | No trusted host is configured by default. |
| Command Mode | NFPP configuration mode |
| Usage Guide | If you do not want to monitor a host, you can run the following commands to configure the host to be trusted. This trusted host can send ARP packets to the CPU, without any rate limiting or alarm reporting. |

Verification

When a network host sends ARP attack packets to a switch configured with ARP attack detection and rate limiting, check whether these packets can be sent to the CPU.

- If the rate of packets not meeting trusted host configuration exceeds the attack threshold or scanning threshold, attack prompt information is displayed.
- If the rate of attack packets meets the trusted host configuration, no prompt information is displayed.

Configuration Example

📄 CPU Protection Based on ARP Guard

| | |
|----------------------------|--|
| Scenario | <ul style="list-style-type: none"> ● ARP host attacks exist in the system, and some hosts fail to properly establish an ARP connection. ● ARP scanning exists in the system, causing a very high CPU usage. ● ARP packet traffic of some hosts is very large in the system, and these packets need to pass through. |
| Configuration Steps | <ul style="list-style-type: none"> ● Set the host-based attack threshold to 5 pps. ● Set the ARP scanning threshold to 10 pps. ● Set the isolation period to 180 pps. ● Configure trusted hosts. |
| | <pre>Ruijie# configure terminal Ruijie(config)# nfpp Ruijie (config-nfpp)#arp-guard rate-limit per-src-mac 5 Ruijie (config-nfpp)#arp-guard attack-threshold per-src-mac 10 Ruijie (config-nfpp)#arp-guard isolate-period 180 Ruijie (config-nfpp)#arp-guard trusted-host 1.1.1.1 0000.0000.1111</pre> |
| Verification | <ul style="list-style-type: none"> ● Run the show nfpp arp-guard summary command to display the configurations. |

| |
|---|
| <pre>(Format of column Rate-limit and Attack-threshold is per-src-ip/per-src-mac/per-port.) Interface Status Isolate-period Rate-limit Attack-threshold Scan-threshold Global Disable 180 4/5/100 8/10/200 15 Maximum count of monitored hosts: 1000 Monitor period: 600s</pre> |
| <ul style="list-style-type: none"> ● Run the show nfpp arp-guard hosts command to display monitored hosts. |
| <pre>If col_filter 1 shows '*', it means "hardware do not isolate host". VLAN interface IP address MAC address remain-time(s) ----- 1 Gi0/43 5.5.5.16 - 175 Total: 1 host</pre> |
| <ul style="list-style-type: none"> ● Run the show nfpp arp-guard scan command to display scanned hosts. |
| <pre>VLAN interface IP address MAC address timestamp ----- 1 Gi0/5 - 001a.a9c2.4609 2013-4-30 23:50:32 1 Gi0/5 192.168.206.2 001a.a9c2.4609 2013-4-30 23:50:33 1 Gi0/5 - 001a.a9c2.4609 2013-4-30 23:51:33 1 Gi0/5 192.168.206.2 001a.a9c2.4609 2013-4-30 23:51:34 Total: 4 record(s)</pre> |
| <ul style="list-style-type: none"> ● Run the show nfpp arp-guard trusted-host command to display trusted hosts. |
| <pre>IP address mac ----- 1.1.1.1 0000.0000.1111 Total: 1 record(s)</pre> |

3.4.2 Configuring IP Anti-scanning

Configuration Effect

- IP attacks are identified based on hosts or ports. In host-based IP attack identification, IP attacks are identified based on the source IP address, VLAN ID, and port. Each type of attack identification has a rate limit and an alarm threshold. If the IP packet rate exceeds the rate limit, the packets beyond the rate limit are discarded. If the IP packet rate exceeds

the alarm threshold, the system prints alarm information and sends Trap packets. In host-based attack identification, the system also isolates the attack source.

- IP guard can also detect IP scanning attacks. IP anti-scanning applies to IP packet attacks as follows: the destination IP address continuously changes but the source IP address remains the same, and the destination IP address is not the IP address of the local device.
- IP anti-scanning applies to IP packet attacks where the destination IP address is not the local IP address. The CPP limits the rate of IP packets where the destination IP address is the local IP address.

Notes

- For a command that is configured both in global configuration mode and interface configuration mode, the configuration in interface configuration mode takes priority over that configured in global configuration mode.
- Isolation is disabled by default. If isolation is enabled, attackers will occupy entries of the security module.

Configuration Steps

▾ Enabling Attack Detection

- (Mandatory) Attack detection is enabled by default.
- Support the global configuration mode or interface configuration mode on the AP device.
- If IP anti-scanning is disabled, the system automatically clears monitored hosts.

| | |
|---------------------|---|
| Command | ip-guard enable |
| Parameter | N/A |
| Description | |
| Defaults | IP anti-scanning is enabled by default. |
| Command Mode | NFPP configuration mode |
| Usage Guide | N/A |

| | |
|---------------------|---|
| Command | nfpp ip-guard enable |
| Parameter | N/A |
| Description | |
| Defaults | IP anti-scanning is configured in global configuration mode, but not in interface configuration mode. |
| Command Mode | Interface configuration mode |
| Usage Guide | IP anti-scanning configured in interface configuration mode takes priority over that configured in global configuration mode. |

▾ Configuring the Isolation Period

- (Optional) Isolation is disabled by default.

- If the packet traffic of attackers exceeds the rate limit of the CPP, you can configure the isolation period to directly discard packets and therefore save bandwidth resources.
- Support the global configuration mode or interface configuration mode on the AP device.
- If the isolation period is changed to 0, attackers under the corresponding port is deleted, instead of being monitored by software.

| | |
|------------------------------|--|
| Command | ip-guard isolate-period [<i>seconds</i> permanent] |
| Parameter Description | <i>seconds</i> : Indicates the isolation period in the unit of second. It can be set to 0 or any value from 30 to 86,400. permanent : Indicates permanent isolation. |
| Defaults | The default global isolation period is 0, that is, no isolation. |
| Command Mode | NFPP configuration mode |
| Usage Guide | N/A |

| | |
|------------------------------|--|
| Command | nfpp ip-guard isolate-period [<i>seconds</i> permanent] |
| Parameter Description | <i>seconds</i> : Indicates the isolation period in the unit of second. It can be set to 0 or any value from 30 to 86,400. The value 0 indicates no isolation. permanent : Indicates permanent isolation. |
| Defaults | By default, a global isolation period is used, but no local isolation period is configured. |
| Command Mode | Interface configuration mode |
| Usage Guide | N/A |

📌 Configuring the Monitoring Period

- Mandatory.
- If the isolation period is configured, it is directly used as the attacker monitoring period, and the configured monitoring period does not take effect.
- Support the global configuration mode on the AP device.

| | |
|------------------------------|---|
| Command | ip-guard monitor-period <i>seconds</i> |
| Parameter Description | <i>seconds</i> : Indicates the monitoring period in the unit of second. The value ranges from 180 to 86,400. |
| Defaults | The default monitoring period is 600 seconds. |
| Command Mode | NFPP configuration mode |
| Usage Guide | If the isolation period is changed to 0, attackers under the corresponding port is deleted, instead of being monitored by software. |

📌 Configuring the Maximum Number of Monitored Hosts

- Mandatory.
- Increase the maximum number of monitored hosts. As the number of actually monitored hosts increases, more CPU resources are used to handle monitored hosts.
- Support the global configuration mode on the AP device.
- If the number of monitored hosts reaches 1000 (default value), the administrator can set the maximum number of monitored hosts to a value smaller than 1000. In this case, the system does not delete monitored hosts but prints the information "%ERROR: The value that you configured is smaller than current monitored hosts 1000, please clear a part of monitored hosts." This information notifies the administrator that the configuration does not take effect and that part of monitored hosts need to be deleted.
- If the table of monitored hosts is full, the system prints the log "% NFPP_IP_GUARD-4-SESSION_LIMIT: Attempt to exceed limit of 1000 monitored hosts." to notify the administrator.

| | |
|------------------------------|---|
| Command | ip-guard monitored-host-limit <i>number</i> |
| Parameter Description | <i>number</i> : Indicates the maximum number of monitored hosts, ranging from 1 to 4,294,967,295. |
| Defaults | The maximum number of monitored hosts is 1000 by default. |
| Command Mode | NFPP configuration mode |
| Usage Guide | N/A |

📌 Configuring the Attack Threshold

- Mandatory.
- Support the global configuration mode or interface configuration mode on the AP device.
- If the configured rate limit is greater than the attack threshold, the system prints the log "%ERROR: rate limit is higher than attack threshold 500pps." to notify the administrator.
- If the configured attack threshold is smaller than the rate limit, the system prints the log "%ERROR: attack threshold is smaller than rate limit 300pps." to notify the administrator.
- If the memory cannot be allocated to detected attackers, the system prints the log "%NFPP_IP_GUARD-4-NO_MEMORY: Failed to alloc memory." to notify the administrator.
- Source IP address-based rate limiting takes priority over port-based rate limiting.
- In NFPP configuration mode: run the **ip-guard rate-limit { per-src-ip | per-port } pps** command to configure the global rate limit.
- In NFPP configuration mode: run the **ip-guard attack-threshold { per-src-ip | per-port } pps** command to configure the global attack threshold. That is, when the packet rate exceeds the attack threshold, it is considered that attack behaviors exist.
- In interface configuration mode: run the **nfpp ip-guard policy { per-src-ip | per-port } rate-limit-pps attack-threshold-pps** command to configure the local rate limit and attack threshold on a port.

| | |
|----------------|--|
| Command | ip-guard rate-limit { per-src-ip per-port } pps |
|----------------|--|

| | |
|------------------------------|---|
| Parameter Description | per-src-ip: Limits the rate for each source IP address. per-port: Limits the rate for each port. <i>pps:</i> Indicates the rate limit, ranging from 1 to 9,999. |
| Defaults | per-src-ip: 20 pps. per-port: 1,500 pps. |
| Command Mode | NFPP configuration mode |
| Usage Guide | N/A |

| | |
|------------------------------|--|
| Command | ip-guard attack-threshold { per-src-ip per-port } pps |
| Parameter Description | per-src-ip: Configures the attack threshold for each source IP address. per-port: Configures the attack threshold for each port. <i>pps:</i> Indicates the attack threshold, ranging from 1 to 9,999. The unit is pps. |
| Defaults | per-src-ip: 20 pps. per-port: 1,500 pps. |
| Command Mode | NFPP configuration mode |
| Usage Guide | The attack threshold must be equal to or greater than the rate limit. |

| | |
|------------------------------|---|
| Command | nfpp ip-guard policy { per-src-ip per-port } rate-limit-pps attack-threshold-pps |
| Parameter Description | per-src-ip: Configures the attack threshold for each source IP address. per-port: Configures the attack threshold for each port. <i>rate-limit-pps:</i> Indicates the rate limit, ranging from 1 to 9,999. <i>attack-threshold-pps:</i> Indicates the attack threshold, ranging from 1 to 9,999. |
| Defaults | By default, no rate limit and attack threshold are configured for a port, and the global rate limit and attack threshold are used. |
| Command Mode | Interface configuration mode |
| Usage Guide | The attack threshold must be equal to or greater than the rate limit. |

📌 Configuring the Scanning Threshold

- Mandatory.
- Support the global configuration mode or interface configuration mode on the AP device.
- IP scanning attack may have occurred if IP packets received within 10 seconds meet the following conditions:
 - The source IP address remains the same.
 - The destination IP address continuously changes and is not the local IP address, and the change times exceed the scanning threshold.

| | |
|----------------|--|
| Command | ip-guard scan-threshold pkt-cnt |
|----------------|--|

| | |
|------------------------------|---|
| Parameter Description | <i>pkt-cnt</i> : Indicates the scanning threshold, ranging from 1 to 9,999. |
| Defaults | The default scanning threshold is 100 pps. |
| Command Mode | NFPP configuration mode |
| Usage Guide | N/A |

| | |
|------------------------------|---|
| Command | nfpp ip-guard scan-threshold <i>pkt-cnt</i> |
| Parameter Description | <i>pkt-cnt</i> : Indicates the scanning threshold, ranging from 1 to 9,999. |
| Defaults | By default, no port-based IP scanning threshold is configured and the global IP scanning threshold is used. |
| Command Mode | Interface configuration mode |
| Usage Guide | N/A |

📌 Configuring Trusted Hosts

- (Optional) No trusted host is configured by default.
- For IP anti-scanning, you can configure a maximum of 500 IP addresses not to be monitored.
- Support the global configuration mode on the AP device.
- If any entry matching a trusted host (IP addresses are the same) exists in the table of monitored hosts, the system automatically deletes this entry.
- If the table of trusted hosts is full, the system prints the log "%ERROR: Attempt to exceed limit of 500 trusted hosts." to notify the administrator.
- If the administrator fails to delete a trusted host, the system prints the log "%ERROR: Failed to delete trusted host 1.1.1.0 255.255.255.0." to notify the administrator.
- If you fail to add a trusted host, the system prints the log "%ERROR: Failed to add trusted host 1.1.1.0 255.255.255.0." to notify the administrator.
- If the trusted host you want to add already exists, the system prints the log "%ERROR: Trusted host 1.1.1.0 255.255.255.0 has already been configured." to notify the administrator.
- If the trusted host you want to delete does not exist, the system prints the log "%ERROR: Trusted host 1.1.1.0 255.255.255.0 is not found." to notify the administrator.

| | |
|------------------------------|---|
| Command | ip-guard trusted-host <i>ip mask</i> |
| Parameter Description | <i>ip</i> : Indicates the IP address. <i>mask</i> : Indicates the mask of an IP address. |
| Defaults | No trusted host is configured by default. |
| Command Mode | NFPP configuration mode |

| | |
|--------------------|---|
| Usage Guide | If you do not want to monitor a host, you can run the following commands to configure the host to be trusted. This trusted host can send IP packets to the CPU, without any rate limiting or alarm reporting. |
|--------------------|---|

Verification

When a network host sends IP attack packets to a switch configured with IP attack detection and rate limiting, check whether these packets can be sent to the CPU.

- If the rate of packets not meeting trusted host configuration exceeds the attack threshold or scanning threshold, attack prompt information is displayed.
- If the rate of attack packets meets the trusted host configuration, no prompt information is displayed.

Configuration Example

📌 CPU Protection Based on IP Guard

| Scenario | <ul style="list-style-type: none"> ● IP host attacks exist in the system, and packets of some hosts cannot be properly routed and forwarded. ● IP scanning exists in the system, causing a very high CPU usage. ● Packet traffic of some hosts is very large in the system, and these packets need to pass through. | | | | | | | | | | | | |
|----------------------------|--|----------------|------------|------------------|----------------|------------------|----------------|--------|---------|-----|----------|----------|-----|
| Configuration Steps | <ul style="list-style-type: none"> ● Configure the host-based attack threshold. ● Configure the IP scanning threshold. ● Set the isolation period to a non-zero value. ● Configure trusted hosts. | | | | | | | | | | | | |
| | <pre>Ruijie# configure terminal Ruijie(config)# nfpp Ruijie (config-nfpp)#ip-guard rate-limit per-src-ip 20 Ruijie (config-nfpp)#ip-guard attack-threshold per-src-ip 30 Ruijie (config-nfpp)#ip-guard isolate-period 180 Ruijie (config-nfpp)#ip-guard trusted-host 192.168.201.46 255.255.255.255</pre> | | | | | | | | | | | | |
| Verification | <ul style="list-style-type: none"> ● Run the show nfpp ip-guard summary command to display the configurations. | | | | | | | | | | | | |
| | <p>(Format of column Rate-limit and Attack-threshold is per-src-ip/per-src-mac/per-port.)</p> <table border="1"> <thead> <tr> <th>Interface</th> <th>Status</th> <th>Isolate-period</th> <th>Rate-limit</th> <th>Attack-threshold</th> <th>Scan-threshold</th> </tr> </thead> <tbody> <tr> <td>Global</td> <td>Disable</td> <td>180</td> <td>20/-/100</td> <td>30/-/200</td> <td>100</td> </tr> </tbody> </table> <p>Maximum count of monitored hosts: 1000 Monitor period: 600s</p> | Interface | Status | Isolate-period | Rate-limit | Attack-threshold | Scan-threshold | Global | Disable | 180 | 20/-/100 | 30/-/200 | 100 |
| Interface | Status | Isolate-period | Rate-limit | Attack-threshold | Scan-threshold | | | | | | | | |
| Global | Disable | 180 | 20/-/100 | 30/-/200 | 100 | | | | | | | | |
| | <ul style="list-style-type: none"> ● Run the show nfpp ip-guard hosts command to display monitored hosts. | | | | | | | | | | | | |

| |
|---|
| <pre>If col_filter 1 shows '*', it means "hardware do not isolate host". VLAN interface IP address Reason remain-time(s) ----- 1 Gi0/5 192.168.201.47 ATTACK 160 Total: 1 host</pre> |
| <ul style="list-style-type: none"> ● Run the show nfpp ip-guard trusted-host command to display trusted hosts. |
| <pre>IP address mask ----- 192.168.201.46 255.255.255.255 Total: 1 record(s)</pre> |

3.4.3 Configuring ICMP Guard

Configuration Effect

- ICMP attacks are identified based on hosts or ports. In host-based attack identification, ICMP attacks are identified based on the source IP address, VLAN ID, and port. Each type of attack identification has a rate limit and an alarm threshold. If the ICMP packet rate exceeds the rate limit, the packets beyond the rate limit are discarded. If the ICMP packet rate exceeds the alarm threshold, the system prints alarm information and sends Trap packets. In host-based attack identification, the system also isolates the attack source.

Notes

- For a command that is configured both in global configuration mode and interface configuration mode, the configuration in interface configuration mode takes priority over that configured in global configuration mode.
- Isolation is disabled by default. If isolation is enabled, attackers will occupy entries of the security module.

Configuration Steps

▾ Enabling Attack Detection

- (Mandatory) Attack detection is enabled by default.
- Support the global configuration mode or interface configuration mode on the AP device.
- If ICMP guard is disabled, the system automatically clears monitored hosts.

| | |
|---------------------|-----------------------------------|
| Command | icmp-guard enable |
| Parameter | N/A |
| Description | |
| Defaults | ICMP guard is enabled by default. |
| Command Mode | NFPP configuration mode |

| | |
|--------------------|-----|
| Usage Guide | N/A |
|--------------------|-----|

| | |
|------------------------------|--|
| Command | nfpp icmp-guard enable |
| Parameter Description | N/A |
| Defaults | ICMP guard is configured in global configuration mode, but not in interface configuration mode. |
| Command Mode | Interface configuration mode |
| Usage Guide | ICMP guard configured in interface configuration mode takes priority over that in global configuration mode. |

↘ Configuring the Isolation Period

- (Optional) Isolation is disabled by default.
- If the packet traffic of attackers exceeds the rate limit of the CPP, you can configure the isolation period to directly discard packets and therefore save bandwidth resources.
- Support the global configuration mode or interface configuration mode on the AP device.
- If the isolation period is changed to 0, attackers under the corresponding port is deleted, instead of being monitored by software.

| | |
|------------------------------|--|
| Command | icmp-guard isolate-period [<i>seconds</i> permanent] |
| Parameter Description | <i>seconds</i> : Indicates the isolation period in the unit of second. It can be set to 0 or any value from 30 to 86,400. The value 0 indicates no isolation. permanent : Indicates permanent isolation. |
| Defaults | The default global isolation period is 0, that is, no isolation. |
| Command Mode | NFPP configuration mode |
| Usage Guide | The attacker isolation period falls into two types: global isolation period and port-based isolation period (local isolation period). For a port, if the port-based isolation period is not configured, the global isolation period is used; otherwise, the port-based isolation period is used. |

| | |
|------------------------------|--|
| Command | nfpp icmp-guard isolate-period [<i>seconds</i> permanent] |
| Parameter Description | <i>seconds</i> : Indicates the isolation period in the unit of second. It can be set to 0 or any value from 30 to 86,400. The value 0 indicates no isolation. permanent : Indicates permanent isolation. |
| Defaults | By default, a global isolation period is used, but no local isolation period is configured. |
| Command Mode | Interface configuration mode |
| Usage Guide | N/A |

↘ Configuring the Monitoring Period

- Mandatory.
- If the isolation period is configured, it is directly used as the attacker monitoring period, and the configured monitoring period does not take effect.
- Support the global configuration mode on the AP device.

| | |
|------------------------------|--|
| Command | icmp-guard monitor-period <i>seconds</i> |
| Parameter Description | <i>seconds</i> : Indicates the monitoring period in the unit of second. The value ranges from 180 to 86,400. |
| Defaults | The default monitoring period is 600 seconds. |
| Command Mode | NFPP configuration mode |
| Usage Guide | If the isolation period is 0, the system performs software monitoring on detected attackers. The timeout period is the monitoring period. During software monitoring, if the isolation period is set to a non-zero value, the system automatically performs isolation against attackers monitored by software and sets the timeout period as the monitoring period. The monitoring period is valid only when the isolation period is 0. If the isolation period is changed to 0, attackers under the corresponding port is deleted, instead of being monitored by software. |

▾ Configuring the Maximum Number of Monitored Hosts

- Mandatory.
- Increase the maximum number of monitored hosts. As the number of actually monitored hosts increases, more CPU resources are used to handle monitored hosts.
- Support the global configuration mode on the AP device.
- If the number of monitored hosts exceeds 1000 (default value), the administrator can set the maximum number of monitored hosts to a value smaller than 1000. In this case, the system does not delete monitored hosts but prints the information "%ERROR: The value that you configured is smaller than current monitored hosts 1000, please clear a part of monitored hosts." This information notifies the administrator that the configuration does not take effect and that part of monitored hosts need to be deleted.
- If the table of monitored hosts is full, the system prints the log "% NFPP_ICMP_GUARD-4-SESSION_LIMIT: Attempt to exceed limit of 1000 monitored hosts." to notify the administrator.

| | |
|------------------------------|---|
| Command | icmp-guard monitored-host-limit <i>number</i> |
| Parameter Description | <i>number</i> : Indicates the maximum number of monitored hosts, ranging from 1 to 4,294,967,295. |
| Defaults | The maximum number of monitored hosts is 1000 by default. |
| Command Mode | NFPP configuration mode |
| Usage Guide | If the number of monitored hosts exceeds 1000 (default value), the administrator can set the maximum number of monitored hosts to a value smaller than 1000. In this case, the system does not delete monitored hosts but prints the information "%ERROR: The value that you configured is smaller than current monitored |

hosts 1000, please clear a part of monitored hosts." This information notifies the administrator that the configuration does not take effect and that part of monitored hosts need to be deleted.

If the table of monitored hosts is full, the system prints the log "% NFPP_ICMP_GUARD-4-SESSION_LIMIT: Attempt to exceed limit of 1000 monitored hosts." to notify the administrator.

↘ Configuring the Attack Threshold

- Mandatory.
- Support the global configuration mode or interface configuration mode on the AP device.
- If the configured rate limit is greater than the attack threshold, the system prints the log "%ERROR: rate limit is higher than attack threshold 500pps." to notify the administrator.
- If the configured attack threshold is smaller than the rate limit, the system prints the log "%ERROR: attack threshold is smaller than rate limit 300pps." to notify the administrator.
- If the memory cannot be allocated to detected attackers, the system prints the log "%NFPP_ICMP_GUARD-4-NO_MEMORY: Failed to alloc memory." to notify the administrator.
- Source IP address-based rate limiting takes priority over port-based rate limiting.
- In NFPP configuration mode: run the **icmp-guard rate-limit { per-src-ip | per-port } pps** command to configure the global rate limit.
- In NFPP configuration mode: run the **icmp-guard attack-threshold { per-src-ip | per-port } pps** command to configure the global attack threshold. That is, when the packet rate exceeds the attack threshold, it is considered that attack behaviors exist.
- In interface configuration mode: run the **nfpp icmp-guard policy { per-src-ip | per-port } rate-limit-pps attack-threshold-pps** command to configure the local rate limit and attack threshold on a port.

| | |
|------------------------------|--|
| Command | icmp-guard rate-limit { per-src-ip per-port } pps |
| Parameter Description | per-src-ip: Limits the rate for each source IP address. per-port: Limits the rate for each port. <i>pps</i> : Indicates the rate limit, ranging from 1 to 9,999. |
| Defaults | per-src-ip: 200 pps; per-port: 400 pps. |
| Command Mode | NFPP configuration mode |
| Usage Guide | N/A |

| | |
|------------------------------|---|
| Command | icmp-guard attack-threshold { per-src-ip per-port } pps |
| Parameter Description | per-src-ip: Configures the attack threshold for each source IP address. per-port: Configures the attack threshold for each port. <i>pps</i> : Indicates the attack threshold, ranging from 1 to 9,999. The unit is pps. |
| Defaults | per-src-ip: 200 pps; per-port: 400 pps. |

| | |
|---------------------|-------------------------|
| Command Mode | NFPP configuration mode |
| Usage Guide | N/A |

| | |
|------------------------------|--|
| Command | nfpp icmp-guard policy { per-src-ip per-port } rate-limit-pps attack-threshold-pps |
| Parameter Description | <p>per-src-ip: Configures the rate limit and attack threshold for each source IP address.</p> <p>per-port: Configures the rate limit and attack threshold for each port.</p> <p><i>rate-limit-pps:</i> Indicates the rate limit, ranging from 1 to 9,999.</p> <p><i>attack-threshold-pps:</i> Indicates the attack threshold, ranging from 1 to 9,999.</p> |
| Defaults | By default, no rate limit and attack threshold are configured for a port, and the global rate limit and attack threshold are used. |
| Command Mode | Interface configuration mode |
| Usage Guide | The attack threshold must be equal to or greater than the rate limit. |

📌 Configuring Trusted Hosts

- (Optional) No trusted host is configured by default.
- For ICMP anti-scanning, you can configure a maximum of 500 IP addresses not to be monitored.
- Support the global configuration mode on the AP device.
- If any entry matching a trusted host (IP addresses are the same) exists in the table of monitored hosts, the system automatically deletes this entry.
- If the table of trusted hosts is full, the system prints the log "%ERROR: Attempt to exceed limit of 500 trusted hosts." to notify the administrator.
- If the administrator fails to delete a trusted host, the system prints the log "%ERROR: Failed to delete trusted host 1.1.1.0 255.255.255.0." to notify the administrator.
- If you fail to add a trusted host, the system prints the log "%ERROR: Failed to add trusted host 1.1.1.0 255.255.255.0." to notify the administrator.
- If the trusted host you want to add already exists, the system prints the log "%ERROR: Trusted host 1.1.1.0 255.255.255.0 has already been configured." to notify the administrator.
- If the trusted host you want to delete does not exist, the system prints the log "%ERROR: Trusted host 1.1.1.0 255.255.255.0 is not found." to notify the administrator.

| | |
|------------------------------|--|
| Command | icmp-guard trusted-host ip mask |
| Parameter Description | <p><i>ip:</i> Indicates the IP address.</p> <p><i>mask:</i> Indicates the mask of an IP address.</p> |
| Defaults | No trusted host is configured by default. |
| Command Mode | NFPP configuration mode |

| | |
|--------------------|---|
| Usage Guide | <p>If you do not want to monitor a host, you can run the following commands to configure the host to be trusted. This trusted host can send ICMP packets to the CPU, without any rate limiting or alarm reporting. You can configure the mask so that no host in one network segment is monitored.</p> <p>You can configure a maximum of 500 trusted hosts.</p> |
|--------------------|---|

Verification

When a network host sends ICMP attack packets to a switch configured with ICMP attack detection and rate limiting, check whether these packets can be sent to the CPU.

- If the rate of packets not meeting trusted host configuration exceeds the attack threshold, attack prompt information is displayed.
- If the rate of attack packets meets the trusted host configuration, no prompt information is displayed.

Configuration Example

📌 CPU Protection Based on ICMP Guard

| | |
|----------------------------|--|
| Scenario | <ul style="list-style-type: none"> ● ICMP host attacks exist in the system, and some hosts cannot successfully ping devices. ● Packet traffic of some hosts is very large in the system, and these packets need to pass through. |
| Configuration Steps | <ul style="list-style-type: none"> ● Configure the host-based attack threshold. ● Set the isolation period to a non-zero value. ● Configure trusted hosts. <pre>Ruijie# configure terminal Ruijie(config)# nfpp Ruijie (config-nfpp)#icmp-guard rate-limit per-src-ip 20 Ruijie (config-nfpp)#icmp-guard attack-threshold per-src-ip 30 Ruijie (config-nfpp)#icmp-guard isolate-period 180 Ruijie (config-nfpp)#icmp-guard trusted-host 192.168.201.46 255.255.255.255</pre> |
| Verification | <ul style="list-style-type: none"> ● Run the show nfpp icmp-guard summary command to display the configurations. <pre>(Format of column Rate-limit and Attack-threshold is per-src-ip/per-src-mac/per-port.) Interface Status Isolate-period Rate-limit Attack-threshold Global Disable 180 20/-/400 30/-/400 Maximum count of monitored hosts: 1000 Monitor period: 600s</pre> <ul style="list-style-type: none"> ● Run the show nfpp icmp-guard hosts command to display monitored hosts. |

| |
|--|
| <pre>If col_filter 1 shows '*', it means "hardware do not isolate host". VLAN interface IP address remain-time(s) ----- - 1 Gi0/5 192.168.201.47 160 Total: 1 host</pre> |
| <ul style="list-style-type: none"> ● Run the show nfpp icmp-guard trusted-host command to display trusted hosts. |
| <pre>IP address mask ----- 192.168.201.46 255.255.255.255 Total: 1 record(s)</pre> |

3.4.4 Configuring DHCP Guard

Configuration Effect

- DHCP attacks are identified based on hosts or ports. In host-based attack identification, DHCPv6 attacks are identified based on the link-layer source IP address, VLAN ID, and port. Each type of attack identification has a rate limit and an alarm threshold. If the DHCP packet rate exceeds the rate limit, the packets beyond the rate limit are discarded. If the DHCP packet rate exceeds the alarm threshold, the system prints alarm information and sends Trap packets. In host-based attack identification, the system also isolates the attack source.

Notes

- For a command that is configured both in global configuration mode and interface configuration mode, the configuration in interface configuration mode takes priority over that configured in global configuration mode.
- Isolation is disabled by default. If isolation is enabled, attackers will occupy entries of the security module.

Configuration Steps

📌 Enabling Attack Detection

- (Mandatory) Attack detection is enabled by default.
- Support the global configuration mode or interface configuration mode on the AP device.
- If DHCP guard is disabled, the system automatically clears monitored hosts.

| | |
|---------------------|---|
| Command | dhcp-guard enable |
| Parameter | N/A |
| Description | |
| Defaults | Attack detection is enabled by default. |
| Command Mode | NFPP configuration mode |

| | |
|--------------------|-----|
| Usage Guide | N/A |
|--------------------|-----|

| | |
|------------------------------|---|
| Command | nfpp dhcp-guard enable |
| Parameter Description | N/A |
| Defaults | DHCP guard is configured in global configuration mode, but not in interface configuration mode. |
| Command Mode | Interface configuration mode |
| Usage Guide | DHCP guard configured in interface configuration mode takes priority over that configured in global configuration mode. |

↘ Configuring the Isolation Period

- (Optional) Isolation is disabled by default.
- If the packet traffic of attackers exceeds the rate limit of the CPP, you can configure the isolation period to directly discard packets and therefore save bandwidth resources.
- Support the global configuration mode or interface configuration mode on the AP device.
- If the isolation period is changed to 0, attackers under the corresponding port is deleted, instead of being monitored by software.

| | |
|------------------------------|--|
| Command | dhcp-guard isolate-period [<i>seconds</i> permanent] |
| Parameter Description | <i>seconds</i> : Indicates the isolation period in the unit of second. It can be set to 0 or any value from 30 to 86,400. The value 0 indicates no isolation. permanent : Indicates permanent isolation. |
| Defaults | The default global isolation period is 0, that is, no isolation. |
| Command Mode | NFPP configuration mode |
| Usage Guide | The attacker isolation period falls into two types: global isolation period and port-based isolation period (local isolation period). For a port, if the port-based isolation period is not configured, the global isolation period is used; otherwise, the port-based isolation period is used. |

| | |
|------------------------------|--|
| Command | nfpp dhcp-guard isolate-period [<i>seconds</i> permanent] |
| Parameter Description | <i>seconds</i> : Indicates the isolation period in the unit of second. It can be set to 0 or any value from 30 to 86,400. The value 0 indicates no isolation. permanent : Indicates permanent isolation. |
| Defaults | By default, a global isolation period is used, but no local isolation period is configured. |
| Command Mode | Interface configuration mode |
| Usage Guide | N/A |

↘ Configuring the Monitoring Period

- Mandatory.
- If the isolation period is configured, it is directly used as the attacker monitoring period, and the configured monitoring period does not take effect.
- Support the global configuration mode on the AP device.

| | |
|------------------------------|--|
| Command | dhcp-guard monitor-period <i>seconds</i> |
| Parameter Description | <i>seconds</i> : Indicates the monitoring period in the unit of second. The value ranges from 180 to 86,400. |
| Defaults | The default monitoring period is 600 seconds. |
| Command Mode | NFPP configuration mode |
| Usage Guide | If the isolation period is 0, the system performs software monitoring on detected attackers. The timeout period is the monitoring period. During software monitoring, if the isolation period is set to a non-zero value, the system automatically performs isolation against attackers monitored by software and sets the timeout period as the monitoring period. The monitoring period is valid only when the isolation period is 0. If the isolation period is changed to 0, attackers under the corresponding port is deleted, instead of being monitored by software. |

↘ Configuring the Maximum Number of Monitored Hosts

- Mandatory.
- Increase the maximum number of monitored hosts. As the number of actually monitored hosts increases, more CPU resources are used to handle monitored hosts.
- Support the global configuration mode on the AP device.
- If the number of monitored hosts exceeds 1000 (default value), the administrator can set the maximum number of monitored hosts to a value smaller than 1000. In this case, the system does not delete monitored hosts but prints the information "%ERROR: The value that you configured is smaller than current monitored hosts 1000, please clear a part of monitored hosts." This information notifies the administrator that the configuration does not take effect and that part of monitored hosts need to be deleted.
- If the table of monitored hosts is full, the system prints the log "% NFPP_DHCP_GUARD-4-SESSION_LIMIT: Attempt to exceed limit of 1000 monitored hosts." to notify the administrator.

| | |
|------------------------------|---|
| Command | dhcp-guard monitored-host-limit <i>number</i> |
| Parameter Description | <i>number</i> : Indicates the maximum number of monitored hosts, ranging from 1 to 4,294,967,295. |
| Defaults | The maximum number of monitored hosts is 1000 by default. |
| Command Mode | NFPP configuration mode |
| Usage Guide | If the number of monitored hosts exceeds 1000 (default value), the administrator can set the maximum number of monitored hosts to a value smaller than 1000. In this case, the system does not delete monitored hosts but prints the information "%ERROR: The value that you configured is smaller than current monitored |

| | |
|--|--|
| | <p>hosts 1000, please clear a part of monitored hosts." This information notifies the administrator that the configuration does not take effect and that part of monitored hosts need to be deleted.</p> <p>If the table of monitored hosts is full, the system prints the log "%NFPP_DHCP_GUARD-4-SESSION_LIMIT: Attempt to exceed limit of 1000 monitored hosts." to notify the administrator.</p> |
|--|--|

↘ Configuring the Attack Threshold

- Mandatory.
- Support the global configuration mode or interface configuration mode on the AP device.
- If the configured rate limit is greater than the attack threshold, the system prints the log "%ERROR: rate limit is higher than attack threshold 500pps." to notify the administrator.
- If the configured attack threshold is smaller than the rate limit, the system prints the log "%ERROR: attack threshold is smaller than rate limit 300pps." to notify the administrator.
- If the memory cannot be allocated to detected attackers, the system prints the log "%NFPP_DHCP_GUARD-4-NO_MEMORY: Failed to alloc memory." to notify the administrator.
- Source MAC address-based rate limiting takes priority over port-based rate limiting.
- In NFPP configuration mode: run the **dhcp-guard rate-limit { per-src-mac | per-port } pps** command to configure the global rate limit.
- In NFPP configuration mode: run the **dhcp-guard attack-threshold { per-src-mac | per-port } pps** command to configure the global attack threshold. That is, when the packet rate exceeds the attack threshold, it is considered that attack behaviors exist.
- In interface configuration mode: run the **nfpp dhcp-guard policy { per-src-mac | per-port } rate-limit-pps attack-threshold-pps** command to configure the local rate limit and attack threshold on a port.

| | |
|------------------------------|--|
| Command | dhcp-guard rate-limit { per-src-mac per-port } pps |
| Parameter Description | per-src-mac: Limits the rate for each source MAC address. per-port: Limits the rate for each port. <i>pps</i> : Indicates the rate limit, ranging from 1 to 9,999. |
| Defaults | For the AP devices, the default rate limit for packets based on source MAC address is 5 pps, and the default rate limit for packets based on port is 150 pps. |
| Command Mode | NFPP configuration mode |
| Usage Guide | N/A |

| | |
|------------------------------|---|
| Command | dhcp-guard attack-threshold { per-src-mac per-port } pps |
| Parameter Description | per-src-mac: Configures the attack threshold for each source MAC address. per-port: Configures the attack threshold for each port. <i>pps</i> : Indicates the attack threshold, ranging from 1 to 9,999. The unit is pps. |

| | |
|---------------------|--|
| Defaults | For the AP devices, the default rate limit for packets based on source MAC address is 10 pps, and the default rate limit for packets based on port is 300 pps. |
| Command Mode | NFPP configuration mode |
| Usage Guide | N/A |

| | |
|------------------------------|---|
| Command | nfpp dhcp-guard policy { per-src-mac per-port } rate-limit-pps attack-threshold-pps |
| Parameter Description | per-src-mac: Configures the rate limit and attack threshold for each source MAC address. per-port: Configures the rate limit and attack threshold for each port. <i>rate-limit-pps:</i> Indicates the rate limit, ranging from 1 to 9,999. <i>attack-threshold-pps:</i> Indicates the attack threshold, ranging from 1 to 9,999. |
| Defaults | By default, no rate limit and attack threshold are configured for a port, and the global rate limit and attack threshold are used. |
| Command Mode | Interface configuration mode |
| Usage Guide | The attack threshold must be equal to or greater than the rate limit. |

↘ Configuring Trusted Hosts

- (Optional) No trusted host is configured by default.
- For DHCP guard, you can configure a maximum of 500 MAC addresses not to be monitored.
- Support the global configuration mode on the AP device.
- If any entry matching a trusted host (MAC addresses are the same) exists in the table of monitored hosts, the system automatically deletes this entry.
- If the table of trusted hosts is full, the system prints the log "%ERROR: Attempt to exceed limit of 500 trusted hosts." to notify the administrator.
- If the administrator fails to delete a trusted host, the system prints the log "%ERROR: Failed to delete trusted host 0000.0000.1111." to notify the administrator.
- If you fail to add a trusted host, the system prints the log "%ERROR: Failed to add trusted host 0000.0000.1111." to notify the administrator.
- If the trusted host you want to add already exists, the system prints the log "%ERROR: Trusted host 0000.0000.1111 has already been configured." to notify the administrator.
- If the trusted host you want to delete does not exist, the system prints the log "%ERROR: Trusted host 0000.0000.1111 is not found." to notify the administrator.

| | |
|------------------------------|---|
| Command | dhcp-guard trusted-host mac |
| Parameter Description | <i>mac:</i> Indicates the MAC address. |
| Defaults | No trusted host is configured by default. |

| | |
|---------------------|---|
| Command Mode | NFPP configuration mode |
| Usage Guide | If you do not want to monitor a host, you can run the following commands to configure the host to be trusted. This trusted host can send DHCP packets to the CPU, without any rate limiting or alarm reporting. |

Verification

When a network host sends DHCP attack packets to a switch configured with DHCP attack detection and rate limiting, check whether these packets can be sent to the CPU.

- If the rate of packets not meeting trusted host configuration exceeds the attack threshold or scanning threshold, attack prompt information is displayed.
- If the rate of attack packets meets the trusted host configuration, no prompt information is displayed.

Configuration Example

📌 CPU Protection Based on DHCP Guard

| | |
|----------------------------|---|
| Scenario | DHCP host attacks exist in the system, and some hosts fail to request IP addresses. DHCP packet traffic of some hosts is very large in the system, and these packets need to pass through. |
| Configuration Steps | <ul style="list-style-type: none"> ● Configure the host-based attack threshold. ● Set the isolation period to a non-zero value. ● Configure trusted hosts. <pre>Ruijie# configure terminal Ruijie(config)# nfpp Ruijie (config-nfpp)#dhcp-guard rate-limit per-src-mac 8 Ruijie (config-nfpp)#dhcp-guard attack-threshold per-src-mac 16 Ruijie (config-nfpp)#dhcp-guard isolate-period 180 Ruijie (config-nfpp)#dhcp-guard trusted-host 0000.0000.1111</pre> |
| Verification | <ul style="list-style-type: none"> ● Run the show nfpp dhcp-guard summary command to display the configurations. <pre>(Format of column Rate-limit and Attack-threshold is per-src-ip/per-src-mac/per-port.) Interface Status Isolate-period Rate-limit Attack-threshold Global Disable 180 -/8/150 -/16/300 Maximum count of monitored hosts: 1000 Monitor period: 600s</pre> <ul style="list-style-type: none"> ● Run the show nfpp dhcp-guard hosts command to display monitored hosts. |

| |
|--|
| <pre>If col_filter 1 shows '*', it means "hardware do not isolate host". VLAN interface MAC address remain-time(s) ----- *1 Gi0/5 001a.a9c2.4609 160 Total: 1 host</pre> |
| <ul style="list-style-type: none"> ● Run the show nfpp dhcp-guard trusted-host command to display trusted hosts. |
| <pre>mac ----- 0000.0000.1111 Total: 1 record(s)</pre> |

3.4.5 Configuring DHCPv6 Guard

Configuration Effect

- DHCPv6 attacks are identified based on hosts or ports. In host-based attack identification, DHCPv6 attacks are identified based on the link-layer source IP address, VLAN ID, and port. Each type of attack identification has a rate limit and an alarm threshold. If the DHCPv6 packet rate exceeds the rate limit, the packets beyond the rate limit are discarded. If the DHCPv6 packet rate exceeds the alarm threshold, the system prints alarm information and sends Trap packets.
- In host-based attack identification, the system also isolates the attack source.

Notes

- For a command that is configured both in global configuration mode and interface configuration mode, the configuration in interface configuration mode takes priority over that configured in global configuration mode.
- Isolation is disabled by default. If isolation is enabled, attackers will occupy entries of the security module.

Configuration Steps

▾ Enabling Attack Detection

- (Mandatory) Attack detection is enabled by default.
- Support the global configuration mode or interface configuration mode on the AP device.
- If DHCPv6 guard is disabled, the system automatically clears monitored hosts.

| | |
|--------------------|---|
| Command | dhcpv6-guard enable |
| Parameter | N/A |
| Description | |
| Defaults | Attack detection is enabled by default. |

| | |
|---------------------|-------------------------|
| Command Mode | NFPP configuration mode |
| Usage Guide | N/A |

| | |
|------------------------------|---|
| Command | nfpp dhcpv6-guard enable |
| Parameter Description | N/A |
| Defaults | DHCPv6 guard is configured in global configuration mode, but not in interface configuration mode. |
| Command Mode | Interface configuration mode |
| Usage Guide | DHCPv6 guard configured in interface configuration mode takes priority over that configured in global configuration mode. |

↘ Configuring the Isolation Period

- (Optional) Isolation is disabled by default.
- If the packet traffic of attackers exceeds the rate limit of the CPP, you can configure the isolation period to directly discard packets and therefore save bandwidth resources.
- Support the global configuration mode or interface configuration mode on the AP device.
- If the isolation period is changed to 0, attackers under the corresponding port is deleted, instead of being monitored by software.

| | |
|------------------------------|--|
| Command | dhcpv6-guard isolate-period [<i>seconds</i> permanent] |
| Parameter Description | <i>seconds</i> : Indicates the isolation period in the unit of second. It can be set to 0 or any value from 30 to 86,400. The value 0 indicates no isolation. permanent : Indicates permanent isolation. |
| Defaults | The default global isolation period is 0, that is, no isolation. |
| Command Mode | NFPP configuration mode |
| Usage Guide | The attacker isolation period falls into two types: global isolation period and port-based isolation period (local isolation period). For a port, if the port-based isolation period is not configured, the global isolation period is used; otherwise, the port-based isolation period is used. |

| | |
|------------------------------|--|
| Command | nfpp dhcpv6-guard isolate-period [<i>seconds</i> permanent] |
| Parameter Description | <i>seconds</i> : Indicates the isolation period in the unit of second. It can be set to 0 or any value from 30 to 86,400. The value 0 indicates no isolation. permanent : Indicates permanent isolation. |
| Defaults | By default, a global isolation period is used, but no local isolation period is configured. |
| Command Mode | Interface configuration mode |

| | |
|--------------------|---|
| Usage Guide | - |
|--------------------|---|

▾ Configuring the Monitoring Period

- Mandatory.
- If the isolation period is configured, it is directly used as the attacker monitoring period, and the configured monitoring period does not take effect.
- Support the global configuration mode on the AP device.

| | |
|------------------------------|--|
| Command | dhcpv6-guard monitor-period <i>seconds</i> |
| Parameter Description | <i>seconds</i> : Indicates the monitoring period in the unit of second. The value ranges from 180 to 86,400. |
| Defaults | The default monitoring period is 600 seconds. |
| Command Mode | NFPP configuration mode |
| Usage Guide | If the isolation period is 0, the system performs software monitoring on detected attackers. The timeout period is the monitoring period. During software monitoring, if the isolation period is set to a non-zero value, the system automatically performs isolation against attackers monitored by software and sets the timeout period as the monitoring period. The monitoring period is valid only when the isolation period is 0. If the isolation period is changed to 0, attackers under the corresponding port is deleted, instead of being monitored by software. |

▾ Configuring the Maximum Number of Monitored Hosts

- Mandatory.
- Increase the maximum number of monitored hosts. As the number of actually monitored hosts increases, more CPU resources are used to handle monitored hosts.
- Support the global configuration mode on the AP device.
- If the number of monitored hosts exceeds 1000 (default value), the administrator can set the maximum number of monitored hosts to a value smaller than 1000. In this case, the system does not delete monitored hosts but prints the information "%ERROR: The value that you configured is smaller than current monitored hosts 1000, please clear a part of monitored hosts." This information notifies the administrator that the configuration does not take effect and that part of monitored hosts need to be deleted.
- If the table of monitored hosts is full, the system prints the log "% NFPP_DHCPV6_GUARD-4-SESSION_LIMIT: Attempt to exceed limit of 1000 monitored hosts." to notify the administrator.

| | |
|------------------------------|---|
| Command | dhcpv6-guard monitored-host-limit <i>number</i> |
| Parameter Description | <i>number</i> : Indicates the maximum number of monitored hosts, ranging from 1 to 4,294,967,295. |
| Defaults | The maximum number of monitored hosts is 1000 by default. |
| Command Mode | NFPP configuration mode |

| | |
|--------------------|--|
| Usage Guide | <p>If the number of monitored hosts exceeds 1000 (default value), the administrator can set the maximum number of monitored hosts to a value smaller than 1000. In this case, the system does not delete monitored hosts but prints the information "%ERROR: The value that you configured is smaller than current monitored hosts 1000, please clear a part of monitored hosts." This information notifies the administrator that the configuration does not take effect and that part of monitored hosts need to be deleted.</p> <p>If the table of monitored hosts is full, the system prints the log "%NFPP_DHCPV6_GUARD-4-SESSION_LIMIT: Attempt to exceed limit of 1000 monitored hosts." to notify the administrator.</p> |
|--------------------|--|

📌 Configuring the Attack Threshold

- Mandatory.
- Support the global configuration mode or interface configuration mode on the AP device.
- If the configured rate limit is greater than the attack threshold, the system prints the log "%ERROR: rate limit is higher than attack threshold 500pps." to notify the administrator.
- If the configured attack threshold is smaller than the rate limit, the system prints the log "%ERROR: attack threshold is smaller than rate limit 300pps." to notify the administrator.
- If the memory cannot be allocated to detected attackers, the system prints the log "%NFPP_DHCPV6_GUARD-4-NO_MEMORY: Failed to alloc memory." to notify the administrator.
- Source MAC address-based rate limiting takes priority over port-based rate limiting.
- In NFPP configuration mode: run the **dhcpv6-guard rate-limit { per-src-mac | per-port } pps** command to configure the global rate limit.
- In NFPP configuration mode: run the **dhcpv6-guard attack-threshold { per-src-mac | per-port } pps** command to configure the global attack threshold. That is, when the packet rate exceeds the attack threshold, it is considered that attack behaviors exist.
- In interface configuration mode: run the **nfpp dhcpv6-guard policy { per-src-mac | per-port } rate-limit-pps attack-threshold-pps** command to configure the local rate limit and attack threshold on a port.

| | |
|------------------------------|--|
| Command | dhcpv6-guard rate-limit { per-src-mac per-port } pps |
| Parameter Description | <p>per-src-mac: Limits the rate for each source MAC address.</p> <p>per-port: Limits the rate for each port.</p> <p><i>pps:</i> Indicates the rate limit, ranging from 1 to 9,999.</p> |
| Defaults | <p>For the AP devices, the default rate limit for packets based on source MAC address is 5 pps, and the default rate limit for packets based on port is 150 pps.</p> |
| Command Mode | NFPP configuration mode |
| Usage Guide | N/A |

| | |
|----------------|---|
| Command | dhcpv6-guard attack-threshold { per-src-mac per-port } pps |
|----------------|---|

| | |
|------------------------------|--|
| Parameter Description | per-src-mac: Configures the attack threshold for each source MAC address. per-port: Configures the attack threshold for each port. <i>pps:</i> Indicates the attack threshold, ranging from 1 to 9,999. The unit is pps. |
| Defaults | For the AP devices, the default rate limit for packets based on source MAC address is 10 pps, and the default rate limit for packets based on port is 300 pps. |
| Command Mode | NFPP configuration mode |
| Usage Guide | N/A |

| | |
|------------------------------|---|
| Command | nfpp dhcpv6-guard policy { per-src-mac per-port } rate-limit-pps attack-threshold-pps |
| Parameter Description | per-src-mac: Configures the rate limit and attack threshold for each source MAC address. per-port: Configures the rate limit and attack threshold for each port. <i>rate-limit-pps:</i> Indicates the rate limit, ranging from 1 to 9,999. <i>attack-threshold-pps:</i> Indicates the attack threshold, ranging from 1 to 9,999. |
| Defaults | By default, no rate limit and attack threshold are configured for a port, and the global rate limit and attack threshold are used. |
| Command Mode | Interface configuration mode |
| Usage Guide | The attack threshold must be equal to or greater than the rate limit. |

▾ Configuring Trusted Hosts

- (Optional) No trusted host is configured by default.
- For DHCPv6 guard, you can configure a maximum of 500 MAC addresses not to be monitored.
- Support the global configuration mode on the AP device.
- If any entry matching a trusted host (MAC addresses are the same) exists in the table of monitored hosts, the system automatically deletes this entry.
- If the table of trusted hosts is full, the system prints the log "%ERROR: Attempt to exceed limit of 500 trusted hosts." to notify the administrator.
- If the administrator fails to delete a trusted host, the system prints the log "%ERROR: Failed to delete trusted host 0000.0000.1111." to notify the administrator.
- If you fail to add a trusted host, the system prints the log "%ERROR: Failed to add trusted host 0000.0000.1111." to notify the administrator.
- If the trusted host you want to add already exists, the system prints the log "%ERROR: Trusted host 0000.0000.1111 has already been configured." to notify the administrator.
- If the trusted host you want to delete does not exist, the system prints the log "%ERROR: Trusted host 0000.0000.1111 is not found." to notify the administrator.

| | |
|----------------|--------------------------------------|
| Command | dhcpv6-guard trusted-host mac |
|----------------|--------------------------------------|

| | |
|------------------------------|---|
| Parameter Description | <i>mac</i> : Indicates the MAC address. |
| Defaults | No trusted host is configured by default. |
| Command Mode | NFPP configuration mode |
| Usage Guide | If you do not want to monitor a host, you can run the following commands to configure the host to be trusted. This trusted host can send DHCPv6 packets to the CPU, without any rate limiting or alarm reporting. |

Verification

When a network host sends DHCPv6 attack packets to a switch configured with DHCPv6 attack detection and rate limiting, check whether these packets can be sent to the CPU.

- If the rate of packets not meeting trusted host configuration exceeds the attack threshold or scanning threshold, attack prompt information is displayed.
- If an isolation entry needs to be created for the attacker, attacker isolation prompt information is displayed.

Configuration Example

📌 CPU Protection Based on DHCPv6 Guard

| | |
|----------------------------|--|
| Scenario | DHCPv6 host attacks exist in the system, and DHCPv6 neighbor discovery fails on some hosts. DHCPv6 packet traffic of some hosts is very large in the system, and these packets need to pass through. |
| Configuration Steps | <ul style="list-style-type: none"> ● Configure the host-based attack threshold. ● Set the isolation period to a non-zero value. ● Configure trusted hosts. <pre>Ruijie# configure terminal Ruijie(config)# nfpp Ruijie (config-nfpp)#dhcpv6-guard rate-limit per-src-mac 8 Ruijie (config-nfpp)#dhcpv6-guard attack-threshold per-src-mac 16 Ruijie (config-nfpp)#dhcpv6-guard isolate-period 180 Ruijie (config-nfpp)#dhcpv6-guard trusted-host 0000.0000.1111</pre> |
| Verification | <ul style="list-style-type: none"> ● Run the show nfpp dhcpv6-guard summary command to display the configurations. <pre>(Format of column Rate-limit and Attack-threshold is per-src-ip/per-src-mac/per-port.) Interface Status Isolate-period Rate-limit Attack-threshold Global Disable 180 -/8/150 -/16/300 Maximum count of monitored hosts: 1000</pre> |

| | |
|--|---|
| | Monitor period: 600s |
| | <ul style="list-style-type: none"> ● Run the show nfpp dhcpv6-guard hosts command to display monitored hosts. |
| | <pre>If col_filter 1 shows '*', it means "hardware do not isolate host". VLAN interface MAC address remain-time(s) ----- *1 Gi0/5 001a.a9c2.4609 160 Total: 1 host</pre> |
| | <ul style="list-style-type: none"> ● Run the show nfpp dhcpv6-guard trusted-host command to display trusted hosts. |
| | <pre>mac ----- 0000.0000.1111 Total: 1 record(s)</pre> |

3.4.6 Configuring ND Guard

Configuration Effect

- AR ND guard classifies ND packets into three types based on their purposes: 1. NS and NA; 2. RS; 3. RA and Redirect. The first type of packets are used for address resolution. The second type of packets are used by hosts to discover the gateway. The third type of packets are related to routing: RAs are used to advertise the gateway and prefix while Redirect packets are used to advertise a better next hop.
- At present, only port-based ND packet attack identification is supported. You can configure the rate limits and alarm thresholds for these three types of packets. If the ND packet rate exceeds the rate limit, the packets beyond the rate limit are discarded. If the ND packet rate exceeds the alarm threshold, the system prints alarm information and sends Trap packets.

Notes

- For a command that is configured both in global configuration mode and interface configuration mode, the configuration in interface configuration mode takes priority over that configured in global configuration mode.
- Isolation is disabled by default. If isolation is enabled, attackers will occupy entries of the security module.

Configuration Steps

▾ Enabling Attack Detection

- (Mandatory) Attack detection is enabled by default.
- Support the global configuration mode or interface configuration mode on the AP device.

| | |
|----------------|------------------------|
| Command | nd-guard enable |
|----------------|------------------------|

| | |
|------------------------------|---------------------------------|
| Parameter Description | N/A |
| Defaults | ND guard is enabled by default. |
| Command Mode | NFPP configuration mode |
| Usage Guide | N/A |

| | |
|------------------------------|---|
| Command | nfpp nd-guard enable |
| Parameter Description | N/A |
| Defaults | ND guard is configured in global configuration mode, but not in interface configuration mode. |
| Command Mode | Interface configuration mode |
| Usage Guide | ND guard configured in interface configuration mode takes priority over that configured in global configuration mode. |

↘ Configuring the Attack Threshold

- Mandatory.
- Support the global configuration mode or interface configuration mode on the AP device.
- If the configured rate limit is greater than the attack threshold, the system prints the log "%ERROR: rate limit is higher than attack threshold 500pps." to notify the administrator.
- If the configured attack threshold is smaller than the rate limit, the system prints the log "%ERROR: attack threshold is smaller than rate limit 300pps." to notify the administrator.
- If the memory cannot be allocated to detected attackers, the system prints the log "%NFPP_ND_GUARD-4-NO_MEMORY: Failed to alloc memory." to notify the administrator.
- In NFPP configuration mode: run the **nd-guard rate-limit per-port [ns-na | rs | ra-redirect] pps** command to configure the global rate limit.
- In NFPP configuration mode: run the **nd-guard attack-threshold per-port [ns-na | rs | ra-redirect] pps** command to configure the global attack threshold. That is, when the packet rate exceeds the attack threshold, it is considered that attack behaviors exist.
- In interface configuration mode: run the **nfpp nd-guard policy per-port [ns-na | rs | ra-redirect] rate-limit-pps attack-threshold-pps** command to configure the local rate limit and attack threshold on a port.

| | |
|------------------------------|---|
| Command | nd-guard rate-limit per-port [ns-na rs ra-redirect] pps |
| Parameter Description | <p>ns-na: Indicates NSs and NAs.</p> <p>rs: Indicates RSs.</p> <p>ra-redirect: Indicates RAs and Redirect packets.</p> <p><i>pps:</i> Indicates the rate limit, ranging from 1 to 9,999.</p> |
| Defaults | For the AP devices, the default attack threshold for ns-na, rs, and ra-redirect packets is 15 pps. |

| | |
|---------------------|-------------------------|
| Command Mode | NFPP configuration mode |
| Usage Guide | N/A |

| | |
|------------------------------|--|
| Command | nd-guard attack-threshold per-port [ns-na rs ra-redirect] pps |
| Parameter Description | <p>ns-na: Indicates NSs and NAs.</p> <p>rs: Indicates RSs.</p> <p>ra-redirect: Indicates RAs and Redirect packets.</p> <p><i>pps:</i> Indicates the attack threshold, ranging from 1 to 9,999. The unit is pps.</p> |
| Defaults | For the AP devices, the default attack threshold for ns-na, rs, and ra-redirect packets is 30 pps. |
| Command Mode | NFPP configuration mode |
| Usage Guide | The attack threshold must be equal to or greater than the rate limit. |

| | |
|------------------------------|--|
| Command | nfpp nd-guard policy per-port [ns-na rs ra-redirect] rate-limit-pps attack-threshold-pps |
| Parameter Description | <p>ns-na: Indicates NSs and NAs.</p> <p>rs: Indicates RSs.</p> <p>ra-redirect: Indicates RAs and Redirect packets.</p> <p><i>rate-limit-pps:</i> Indicates the rate limit, ranging from 1 to 9,999.</p> <p><i>attack-threshold-pps:</i> Indicates the attack threshold, ranging from 1 to 9,999.</p> |
| Defaults | By default, no rate limit and attack threshold are configured for a port, and the global rate limit and attack threshold are used. |
| Command Mode | Interface configuration mode |
| Usage Guide | <p>The attack threshold must be equal to or greater than the rate limit.</p> <p>ND snooping classifies ports into two types: untrusted ports (connecting the host) and trusted ports (connecting to the gateway). As traffic on a trusted port is usually larger than that on an untrusted port, the rate limit for a trusted port is higher than that for an untrusted port. If ND snooping is enabled for a trusted port, ND snooping sets the rate limit to 800 pps and the attack threshold to 900 pps for the three types of packets on the port by advertising ND guard.</p> <p>ND guard treats the rate limit configured for ND snooping and that configured by the administrator in the same way. The value configured later overwrites the value configured earlier and is stored in the configuration file. The attack threshold configured for ND snooping is treated in a similar way.</p> |

📌 Configuring Trusted Hosts

- (Optional) No trusted host is configured by default.
- For ND guard, you can configure a maximum of 500 MAC addresses not to be monitored.
- Support the global configuration mode on the AP device.

- If the table of trusted hosts is full, the system prints the log "%ERROR: Attempt to exceed limit of 500 trusted hosts." to notify the administrator.
- If the administrator fails to delete a trusted host, the system prints the log "%ERROR: Failed to delete trusted host 0000.0000.1111." to notify the administrator.
- If you fail to add a trusted host, the system prints the log "%ERROR: Failed to add trusted host 0000.0000.1111." to notify the administrator.
- If the trusted host you want to add already exists, the system prints the log "%ERROR: Trusted host 0000.0000.1111 has already been configured." to notify the administrator.
- If the trusted host you want to delete does not exist, the system prints the log "%ERROR: Trusted host 0000.0000.1111 is not found." to notify the administrator.

| | |
|---------------------|---|
| Command | nd-guard trusted-host <i>mac</i> |
| Parameter | <i>mac</i> : Indicates the MAC address. |
| Description | |
| Defaults | No trusted host is configured by default. |
| Command Mode | NFPP configuration mode |
| Usage Guide | If you do not want to monitor a host, you can run the following commands to configure the host to be trusted. This trusted host can send ND packets to the CPU, without any rate limiting or alarm reporting. |

Verification

When a network host sends ND attack packets to a switch configured with ND attack detection and rate limiting, check whether these packets can be sent to the CPU.

- If the rate of packets not meeting trusted host configuration exceeds the attack threshold for a port, attack prompt information is displayed.
- If the rate of attack packets meets the trusted host configuration, no prompt information is displayed.

Configuration Example

📄 CPU Protection Based on ND Guard

| | |
|----------------------------|---|
| Scenario | ND host attacks exist in the system, and neighbor discovery fails on some hosts. ND packet traffic of some hosts is very large in the system, and these packets need to pass through. |
| Configuration Steps | <ul style="list-style-type: none"> ● Configure the host-based attack threshold. <pre>Ruijie# configure terminal Ruijie(config)# nfpp Ruijie (config-nfpp)# nd-guard rate-limit per-port ns-na 30 Ruijie (config-nfpp)# nd-guard attack-threshold per-port ns-na 50</pre> |

| | |
|---------------------|---|
| | Ruijie (config-nfpp)#nd-guard trusted-host 0000.0000.1111 |
| Verification | <ul style="list-style-type: none"> Run the show nfpp nd-guard summary command to display the configurations. |
| | <pre>(Format of column Rate-limit and Attack-threshold is NS-NA/RS/RA-REDIRECT.) Interface Status Rate-limit Attack-threshold Global Disable 30/15/15</pre> |
| | <ul style="list-style-type: none"> Run the show nfpp nd-guard trusted-host command to display trusted hosts. |
| | <pre>mac ----- 0000.0000.1111 Total: 1 record(s)</pre> |

3.4.7 Configuring Centralized Rate Limiting and Distribution

Configuration Effect

Configure centralized rate limiting and distribution so that Manage and Protocol packets are first processed when the network is busy.

Notes

The valid percentage range of a type of packets must be equal to or smaller than (100% – percentage of the sum of the other two types).

Configuration Steps

Configuring the Maximum Bandwidth for Each Type of Packets

- (Mandatory) Manage, Route, and Protocol packets share the same default bandwidth. For details, see the *Product Features*.
- Support the global configuration mode on the AP device.

| | |
|------------------------------|---|
| Command | cpu-protect sub-interface { manage protocol route } pps pps_value |
| Parameter Description | <p>manage: Specifies Manage packets.</p> <p>protocol: Specifies Protocol packets.</p> <p>route: Specifies Route packets.</p> <p><i>pps_value:</i> Indicates the rate limit, ranging from 1 to 100,000.</p> |
| Defaults | For the AP devices, the default rate limit of manage, protocol and route packets is 3,000 pps. |
| Command Mode | Global configuration mode |
| Usage Guide | N/A |

▾ Configuring the Maximum Percentage of Each Type of Packets in the Queue

- (Mandatory) By default, Manage packets occupy 30% of the bandwidth, Route packets occupy 40%, and Protocol packets occupy 25%.
- Support the global configuration mode on the AP device.

| | |
|------------------------------|---|
| Command | cpu-protect sub-interface { manage protocol route } percent <i>percent_value</i> |
| Parameter Description | <p>manage: Specifies Manage packets.</p> <p>protocol: Specifies Protocol packets.</p> <p>route: Specifies Route packets.</p> <p><i>percent_value:</i> Indicates the percentage of a type of packets in the queue, ranging from 1 to 100.</p> |
| Defaults | <p>manage: 30%</p> <p>protocol: 25%</p> <p>route: 40%</p> |
| Command Mode | Global configuration mode |
| Usage Guide | The valid percentage range of a type of packets must be equal to or smaller than (100% – percentage of the sum of the other two types). |

Configuration Example

▾ Prioritizing Packets Sent to the CPU Through Centralized Distribution

| | |
|----------------------------|---|
| Scenario | <ul style="list-style-type: none"> ● Various types of mass packets exist in the network and belong to different centralized types. |
| Configuration Steps | <ul style="list-style-type: none"> ● Configure the maximum bandwidth for each type of packets. ● Configure the maximum percentage of each type of packets in the queue. |
| | <pre>Ruijie# configure terminal Ruijie(config)# cpu-protect sub-interface manage pps 5000 Ruijie(config)# cpu-protect sub-interface manage percent 25</pre> |
| Verification | Omitted. |

3.4.8 Configuring NFPP Log Information

Configuration Effect

NFPP obtains a log from the dedicated log buffer at a certain rate, generates a system message, and clears this log from the dedicated log buffer.

Notes

Logs are continuously printed in the log buffer, even if attacks have stopped.

Configuration Steps

↘ Configuring the Log Buffer Capacity

- Mandatory.
- If the log buffer is full, new logs are discarded and a corresponding prompt is displayed.
- If the log buffer overflows, subsequent logs are discarded and an entry with all attributes marked with a hyphen (-) is displayed in the log buffer. The administrator needs to increase the log buffer capacity or the system message generation rate.
- Support the global configuration mode on the AP device.

| | |
|------------------------------|--|
| Command | log-buffer entries <i>number</i> |
| Parameter Description | <i>number</i> : Indicates the buffer size in unit of the number of logs, ranging from 0 to 1024. |
| Defaults | The default buffer size is 256. |
| Command Mode | NFPP configuration mode |
| Usage Guide | - |

↘ Configuring the System Message Generation Rate

- Mandatory.
- The system message generation rate depends on two parameters: the time segment length and the number of system messages generated in the time segment.
- If both of the preceding two parameters are set to 0, system messages are immediately generated for logs but are not stored in the log buffer.
- Support the global configuration mode on the AP device.

| | |
|------------------------------|--|
| Command | log-buffer logs <i>number_of_message interval length_in_seconds</i> |
| Parameter Description | <i>number_of_message</i> : Ranges from 0 to 1,024. The value 0 indicates that all logs are recorded in the log buffer and no system message is generated. <i>length_in_seconds</i> : Ranges from 0 to 86,400 (1 day). The value 0 indicates that logs are not recorded in the log buffer but system messages are instantly generated. This also applies to <i>number_of_message</i> and <i>length_in_seconds</i> . <i>number_of_message/length_in_second</i> : Indicates the system message generation rate. |
| Defaults | The default value of <i>number_of_message</i> is 1 and the default value of <i>length_in_seconds</i> is 30. |
| Command Mode | NFPP configuration mode |
| Usage Guide | |

↘ Enabling Log Filtering

- (Optional) Log filtering is disabled by default.

- Logs can be filtered based on a port or VLAN.
- If log filtering is enabled, logs not meeting the filtering rule are discarded.
- Support the global configuration mode on the AP device.

| | |
|------------------------------|--|
| Command | logging vlan <i>vlan-range</i> |
| Parameter Description | <i>vlan-range</i> : Records logs in a specified VLAN range. The value format is "1-3,5 for example. |
| Defaults | All logs are recorded by default. |
| Command Mode | NFPP configuration mode |
| Usage Guide | Run this command to filter logs so that only logs in the specified VLAN range are recorded. Between port-based log filtering and VLAN-based log filtering, if either rule is met, logs are recorded in the log buffer. |

| | |
|------------------------------|--|
| Command | logging interface <i>interface-id</i> |
| Parameter Description | <i>interface-id</i> : Records logs of a specified port. |
| Defaults | All logs are recorded by default. |
| Command Mode | NFPP configuration mode |
| Usage Guide | Run this command to filter logs so that only logs of the specified port are recorded. Between port-based log filtering and VLAN-based log filtering, if either rule is met, logs are recorded in the log buffer. |

Configuration Example

📌 CPU Protection Based on ND Guard

| | |
|----------------------------|---|
| Scenario | <ul style="list-style-type: none"> ● If there are too many attackers, log printing will affect the usage of user interfaces and must be restricted. |
| Configuration Steps | <ul style="list-style-type: none"> ● Configure the log buffer capacity. ● Configure the system message generation rate. ● Configure VLAN-based log filtering. |
| | <pre>Ruijie# configure terminal Ruijie(config)# nfpp Ruijie (config-nfpp)#log-buffer entries 1024 Ruijie (config-nfpp)#log-buffer logs 3 interval 5 Ruijie (config-nfpp)#logging interface vlan 1</pre> |
| Verification | <ul style="list-style-type: none"> ● Run the show nfpp log summary command to display the configurations. |

| <pre>Total log buffer size : 1024 Syslog rate : 3 entry per 5 seconds Logging: VLAN 1</pre> | | | | | | | | | | | | | | | | | | | | | |
|---|----------|-----------|---------------|----------------|-------------|-----------------|-----------|-------|-------|-------|-------|-------|-------|-------|-----|---|-------|---------------|----------------|------|-----------------|
| <ul style="list-style-type: none"> Run the show nfpp log buffer command to display logs in the log buffer. | | | | | | | | | | | | | | | | | | | | | |
| <table border="1"> <thead> <tr> <th>Protocol</th> <th>VLAN</th> <th>Interface</th> <th>IP address</th> <th>MAC address</th> <th>Reason</th> <th>Timestamp</th> </tr> <tr> <th>-----</th> <th>-----</th> <th>-----</th> <th>-----</th> <th>-----</th> <th>-----</th> <th>-----</th> </tr> </thead> <tbody> <tr> <td>ARP</td> <td>1</td> <td>Gi0/5</td> <td>192.168.206.2</td> <td>001a.a9c2.4609</td> <td>SCAN</td> <td>2013-5-1 5:4:24</td> </tr> </tbody> </table> | Protocol | VLAN | Interface | IP address | MAC address | Reason | Timestamp | ----- | ----- | ----- | ----- | ----- | ----- | ----- | ARP | 1 | Gi0/5 | 192.168.206.2 | 001a.a9c2.4609 | SCAN | 2013-5-1 5:4:24 |
| Protocol | VLAN | Interface | IP address | MAC address | Reason | Timestamp | | | | | | | | | | | | | | | |
| ----- | ----- | ----- | ----- | ----- | ----- | ----- | | | | | | | | | | | | | | | |
| ARP | 1 | Gi0/5 | 192.168.206.2 | 001a.a9c2.4609 | SCAN | 2013-5-1 5:4:24 | | | | | | | | | | | | | | | |

3.5 Monitoring

Clearing

| Description | Command |
|---|--------------------------------------|
| Clears the ARP guard scanning table. | clear nfpp arp-guard scan |
| Clears monitored hosts in ARP guard. | clear nfpp arp-guard hosts |
| Clears monitored hosts in IP guard. | clear nfpp ip-guard hosts |
| Clears monitored hosts in IMCP guard. | clear nfpp icmp-guard hosts |
| Clears monitored hosts in DHCP guard. | clear nfpp dhcp-guard hosts |
| Clears monitored hosts in DHCPv6 guard. | clear nfpp dhcpv6-guard hosts |
| Clears logs. | clear nfpp log |

Displaying

| Description | Command |
|---|---|
| Displays configuration parameters of ARP guard. | show nfpp arp-guard summary |
| Displays monitored hosts of ARP guard. | show nfpp arp-guard hosts |
| Displays the ARP guard scanning table. | show nfpp arp-guard scan |
| Displays trusted hosts in ARP guard. | show nfpp arp-guard trusted-host |
| Displays configuration parameters of IP guard. | show nfpp ip-guard summary |

| Description | Command |
|--|--|
| Displays monitored hosts in IP guard. | show nfpp ip-guard hosts |
| Displays trusted hosts in IP guard. | show nfpp ip-guard trusted-host |
| Displays configuration parameters of ICMP guard. | show nfpp icmp-guard summary |
| Displays monitored hosts in ICMP guard. | show nfpp icmp-guard hosts |
| Displays trusted hosts in ARP guard. | show nfpp icmp-guard trusted-host |
| Displays configuration parameters of DHCP guard. | show nfpp dhcp-guard summary |
| Displays monitored hosts in DHCP guard. | show nfpp dhcp-guard hosts |
| Displays trusted hosts in DHCP guard. | show nfpp dhcp-guard trusted-host |
| Displays configuration parameters of DHCPv6 guard. | show nfpp dhcpv6-guard summary |
| Displays monitored hosts in DHCPv6 guard. | show nfpp dhcpv6-guard hosts |
| Displays trusted hosts in DHCPv6 guard. | show nfpp dhcpv6-guard trusted-host |
| Displays configuration parameters of ND guard. | show nfpp nd-guard summary |
| Displays trusted hosts in ND guard. | show nfpp nd-guard trusted-host |
| Displays NFPP logs. | show nfpp log summary |
| Displays the NFPP log buffer. | show nfpp log buffer [statistics] |



WLAN QoS Configuration

1 Configuring WLAN QoS

1 Configuring WLAN QoS

1.1 Overview

WLAN QoS (WQoS) is a wireless bandwidth control technology. It involves rate limiting and fair scheduling,.

Rate limiting is used to limit the traffic of access points (APs), WLAN, or STAs, thus preventing the traffic from exceeding a specified range. Rate limiting is applicable to scenarios where some STAs occupy too much bandwidth and other STAs do not have sufficient bandwidth.

Fair scheduling, by dividing the time equally, resolves the problem that some nodes occupy the air interfaces for a longer time, particularly low-rate nodes. Fair scheduling is applicable to all wireless networks.

Protocols and Standards

- IEEE 802.11e-2005: Amendment 8: Medium Access Control (MAC) Quality of Service Enhancements, IEEE Computer Society
- Wi-Fi: WMM Specification version 1.1

1.2 Applications

N/A

1.3 Features

Basic Concepts

▾ Rate Limiting

To better utilize the limited network resources and serve more users efficiently, the access device need to support rate limiting. When the traffic rate conforms to the committed rates, packets are allowed to pass; otherwise, packets are discarded.

The following parameters are used to evaluate the traffic:

- Average Data Rate: It is the average flow rate that is allowed. It is also called committed information rate (CIR).
- Burst Data Rate: It is the maximum acceptable rate of each burst data, also called committed burst size (CBS). The configured CBS must be greater than the maximum packet length, that is, the maximum rate at which data is sent in a period of 10 milliseconds. (The CBS in the unit of Kbps is equal to the maximum traffic in a period divided by 10 milliseconds).

▾ Fair Scheduling

Fair scheduling allows STAs in the same frequency band of the same AP to share the wireless network resources provided by the AP fairly. The fair scheduling function can prevent low-speed STAs from decreasing the throughput of the entire wireless network, and provide smoother network experience for STAs. Besides, the fair scheduling function provides users with better experience by monitoring changes in the traffic of each STA intelligently and adjusting the proportion of the wireless bandwidth used by each STA dynamically. In software version later than 10.4(1T19)p1, different priorities can be configured for STAs in fair scheduling so that specified users can preferentially enjoy the wireless bandwidth.

Overview

| Feature | Description |
|---------------------------------|--|
| Rate Limiting | Limit the rates of an AP, a WLAN, or a STA to that the rate does not exceed the limit. |
| Fair Scheduling | Associate a STA with other STAs in the same frequency band of the same AP to share the wireless network resources provided by the AP, thus sharing the bandwidth of the wireless network in a fair manner. |

1.3.1 Rate Limiting

Rate limiting is used to limit the rates of an AP, a WLAN, or a STA to ensure that the rate does not exceed a certain range.

Working Principle

Rate limiting is implemented based on the token bucket.

- The token bucket records the number of bytes that can pass in a certain period of time.
- In each period, the number of data bytes that can pass is calculated based on the configured CIR and CBS, thereby adjusting the size of the token bucket.
- When a packet arrives, the packet size in bytes is compared with the size of the token bucket. When the packet size is smaller than that of the token bucket, the packet is allowed to pass, and the token bucket size decreases with the corresponding amount. When the packet size is greater than that of the token bucket, the packet will be buffered and transmitted after obtaining permission by the token bucket. Packet buffering is also known as Traffic Shaping smoothing the traffic with low fluctuation.
- Currently, on an AP, Traffic Shaping is used to implement rate limiting of an AP, a STA, or a WLAN.

1.3.2 Fair Scheduling

Fair scheduling, by dividing the time equally, resolves the problem that some nodes occupy the air interfaces for a longer time, particularly low-rate nodes.

Working Principle



Owing to the special characteristics of the wireless network, STAs (including APs) on the same network share the air interface resources, which is also a bottleneck of STA performance. This is one of the differences between the wired and wireless networks. Traditional packet scheduling often adopts the first in first out (FIFO) mode. On one wireless network, every STA that needs to transmit data want to occupy the air interface resources whenever possible. Transmission of

overwhelming low-rate packets results in long-time occupation of the air interfaces. Thereby, the lasting queue take-up causes packet loss and degrades the overall performance of the network.

In the real wireless scenarios, STAs often differ in types and performance. Consequently, some STAs always cannot obtain the resources, or get super slow response. What is worse, these STAs cannot access the network, which seriously affects user experience.

To settle the problems, it is essential to ensure that each STA is able to obtain resources on air interfaces fairly. That is, every STA that needs to transmit data can occupy the air interfaces for a fair period of time. Fair scheduling of the wireless links can be achieved by ways as follows: Predict the traffic of every STA based on the STA-specific information (such as negotiated rates and aggregation types) and the valid bytes of packets, convert the traffic to the number of packets that can be transmitted by every STA, and adjust the allowed packet number to allocate the bandwidth to every STA over the air interfaces and implement traffic shaping. With fair scheduling, each STA occupies the air interfaces for an equal period of time, which effectively avoids poor performance of some STAs and thus improves user experience.

1.4 Configuration

| Configuration | Description and Command | |
|---|--|---|
| Configuring Rate Limiting |  (Mandatory) It is used to enable rate limiting. | |
| | wlan-based | Configures WLAN-based rate limiting on an AC. |
| | wlan-qos ap-based | Configures AP-based rate limiting on an AP. |
| | wlan-qos netuser | Configures STA-based rate limiting on an AP. |
| | wlan-qos wlan-based | Configures WLAN-based rate limiting on an AP. |
| Configuring Fair Scheduling |  (Mandatory) It is used to enable fair scheduling. | |
| | fair-schedule | Enables fair scheduling. |
| |  (Optional) It is used to adjust the STA priority during fair scheduling. | |
| | sta-fair | Configures the fair scheduling priority of a STA. |

1.4.1 Configuring Rate Limiting

Configuration Effect

- Only the committed resource is allocated to a stream based on the actual situation of the network, which prevents network congestion caused by burst stream.

Notes

- On a fat AP, CLI commands are configured in global configuration mode.

Configuration Steps

▾ Configuring AP-based Rate Limiting

- Mandatory.
- On a fat AP, run the **wlan-qos ap-based** command in global configuration mode to configure AP-based rate limiting.

| | |
|------------------------------|---|
| Command | wlan-qos ap-based { per-user-limit total-user-limit } { down-streams up-streams } average-data-rate <i>average-data-rate</i> burst-data-rate <i>burst-data-rate</i> wlan-qos ap-based total-user-limit { down-streams up-streams } intelligent |
| Parameter Description | per-user-limit : Indicates that rate limiting is implemented on every STA on the AP. total-user-limit : Indicates that rate limiting is implemented on all STAs on the AP. intelligent : Indicates whether rate limiting is implemented on all STAs on the AP intelligently. down-streams : Indicates that rate limiting is implemented on the downlink traffic of the AP. up-streams : Indicates that rate limiting is implemented on the uplink traffic of the AP. <i>average-data-rate</i> : Indicates CIR. The unit is 8 Kbps. The value ranges from 8 to 261,120. <i>burst-data-rate</i> : Indicates CBS. The unit is 8 Kbps. The value ranges from 8 to 261,120. |
| Defaults | By default, rate limiting is not configured. If total-user-limit is configured, intelligent rate limiting is disabled by default. |
| Command Mode | Global configuration mode |
| Usage Guide | N/A |

▾ Configuring STA-based Rate Limiting

- Mandatory.
- On a fat AP, run the **wlan-qos netuser** command in global configuration mode to configure STA-based rate limiting.

| | |
|------------------------------|---|
| Command | wlan-qos netuser <i>mac-address</i> { inbound outbound } average-data-rate <i>average-data-rate</i> burst-data-rate <i>burst-data-rate</i> |
| Parameter Description | <i>mac-address</i> : Indicates the MAC address of a STA. inbound : Indicates that rate limiting is implemented on the uplink traffic of a STA. outbound : Indicates that rate limiting is implemented on the downlink traffic of a STA. <i>average-data-rate</i> : Indicates CIR. The unit is 8 Kbps. The value ranges from 8 to 261,120. <i>burst-data-rate</i> : Indicates CBS. The unit is 8 Kbps. The value ranges from 8 to 261,120. |
| Defaults | By default, rate limiting is not configured. |
| Command Mode | Global configuration mode |
| Usage Guide | N/A |

▾ Configuring WLAN-based Rate Limiting

- Mandatory.

- On a fat AP, run the **wlan-qos wlan-based** command in global configuration mode to configure WLAN-based rate limiting.

| | |
|------------------------------|--|
| Command | wlan-qos wlan-based { <i>wlan-id</i> <i>ssid</i> } { per-user-limit total-user-limit } { down-streams up-streams } average-data-rate <i>average-data-rate</i> burst-data-rate <i>burst-data-rate</i> wlan-qos wlan-based { <i>wlan-id</i> <i>ssid</i> } total-user-limit { down-streams up-streams } intelligent |
| Parameter Description | per-user-limit: Indicates that rate limiting is implemented on every STA on the WLAN. total-user-limit: Indicates that rate limiting is implemented on all STAs on the WLAN. intelligent: Indicates whether rate limiting is implemented on all STAs on the WLAN intelligently. per-ap-limit: Indicates that AP-based rate limiting is implemented. down-streams: Indicates that rate limiting is implemented on the downlink traffic of the WLAN. up-streams: Indicates that rate limiting is implemented on the uplink traffic of the WLAN. <i>average-data-rate:</i> Indicates CIR. The unit is 8 Kbps. The value ranges from 8 to 261,120. <i>burst-data-rate:</i> Indicates CBS. The unit is 8 Kbps. The value ranges from 8 to 261,120. |
| Defaults | By default, rate limiting is not configured. |
| Command Mode | Global configuration mode |
| Usage Guide | N/A |

Verification

N/A

Configuration Example

N/A

1.4.2 Configuring Fair Scheduling

Configuration Effect

- The fair scheduling function can prevent low-speed STAs from decreasing the throughput of the entire wireless network, and provide smoother network experience for STAs.

Notes

- On a fat AP, configure fair scheduling in global configuration mode, and run the **show running-config** command to display the configurations.

Configuration Steps

▾ Enabling Fair Scheduling

- Mandatory.
- On a fat AP, run the **fair-schedule** command in global configuration mode to enable fair scheduling.
- Enabling fair scheduling can allocate time to STAs in a fair manner.

| | |
|---------------------|---|
| Command | fair-schedule |
| Parameter | N/A |
| Description | |
| Defaults | By default, fair scheduling is enabled. |
| Command Mode | Global configuration mode |
| Usage Guide | N/A |

▾ [Configuring the Fair Scheduling Priority](#)

- (Optional) Perform this configuration if you need to change the fair scheduling priority of a STA.
- On a fat AP, run the **sta-fair** command in global configuration mode to configure the fair scheduling priority.

| | |
|---------------------|--|
| Command | sta-fair <i>mac-address</i> priority <i>priority</i> |
| Parameter | <i>mac-address</i> : Indicates the MAC address of a STA. |
| Description | <i>priority</i> : Indicates the priority. The value ranges from 1 to 6. |
| Defaults | By default, the priority is 1 for all STAs. A greater value indicates a higher priority, and a higher priority indicates that a longer time is allocated to the STA. |
| Command Mode | Global configuration mode |
| Usage Guide | N/A |

[Verification](#)

- Run the **show ap-config run** command to display the configurations.

[Configuration Example](#)

N/A

1.5 Monitoring

[Displaying](#)

N/A



WLAN Networking Configuration

1 Configuring Fat APs

1 Configuring FAT APs

1.1 Overview

An Access Point (AP) is wireless equipment used to control and manage wireless clients.

When frames are transmitted between wireless clients and a LAN, wireless-to-wired and wired-to-wireless transitions are implemented, during which an AP plays the role of a bridge.

Two types of APs are available: Fat Access Points (FATAPs) and Fit Access Points (FITAPs).

- A FAT AP is suitable for family and small-scaled networks and provides full features. Generally, one device can implement access, authentication, routing, VPN, address translation, and even the firewall functions.
- A FIT-AP is suitable for large-scale wireless network deployment. A dedicated wireless controller is needed to provide unified management. A FIT-AP can be used only after the wireless controller delivers configurations and it cannot complete configuration by itself.

Protocols and Standards

- IEEE Std 802.11-2012:Wireless LAN Medium Access Control (MAC) and Physical Layer (PHY) Specifications

1.2 Applications

| Application | Description |
|--|---|
| Configuring a Single BSS | A simplest WLAN can be created through a single Basic Service Set (BSS). All wireless clients are within the same BSS. |
| Configuring Multiple ESSs | Multiple Extended Service Sets (ESSs), which are logic management domains, may be available in a network. When a mobile user accesses a FATAP, the user can be added to an available ESS. |
| Configuring Single ESS and Multiple BSSs (Multiple RF Bands) | A FATAP may support more than one band in single logic management. All bands support the same service set (within the same ESS); however, the bands have different logic coverage ranges because they belong to different BSSs. |

1.2.1 Configuring a Single BSS

Scenario

The range covered by an AP is called a BSS. Each BSS is identified by a BSSID. A simplest WLAN can be created through a single BSS. All wireless clients are within the same BSS. If these wireless clients are assigned the same rights, they can communicate with each other. They can access each other and access hosts in the network. The communication between wireless clients within the same BSS is implemented through a FATAP.

As shown in Figure 1-1, Client1 and Client2 access the 2.4 GHz band and are within BSS1.

- Client1 and Client2 can access each other and access hosts in the network.

Figure 1-1

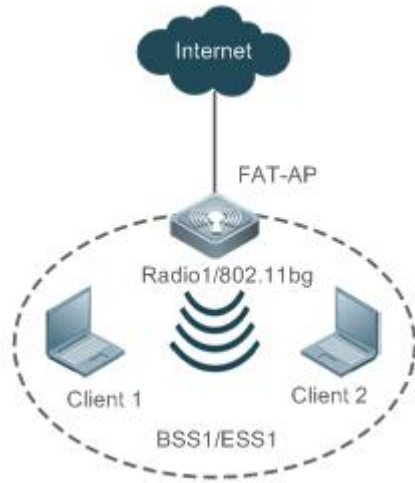

| | |
|----------------|---|
| Remarks | <p>Radio1 is the first RF interface of the FATAP.</p> <p>Client1 and Client2 are wireless clients.</p> <p>The FAT AP, Client1 and Client2 comprise BSS1 and BSS1 belongs to ESS1.</p> |
|----------------|---|

Deployment

- Run the IEEE802.11 protocol on the FAT AP, Client1 and Client2 to implement access and authentication of the wireless clients.
- Configure and manage the FAT AP.
- Run 802.11a or 802.11b on the FAT AP because the FAT AP provides on Radio 1.
- Create only one WLAN on the FAT AP, namely, ESS1. ESS1 must be mapped to Radio1, namely BSS1.

1.2.2 Configuring Multiple ESSs

Scenario

A multiple-ESS topology applies to a network where multiple logical management domains (ESSs) are available. When a mobile user accesses a FAT AP, the user can be added to an available ESS.

Generally, a FAT AP provides multiple logical ESSs. The FAT AP broadcasts the current information of the ESSs configured on the FAT AP by sending beacon or probe response frames in the network. Clients can select ESSs for access based on actual requirements.

Different ESS domains can be configured on the FAT AP. After being configured, the FAT AP is allowed to announce and accept users in the ESS domains after the users are authenticated.

As shown in Figure 1-2, Client1 and Client 2 access the 2.4 GHz band. Client1 belongs to ESS1 whereas Client2 belongs to Client2. Client1 belongs to BSS1 whereas Client2 belongs to BSS2.

Figure 1-2

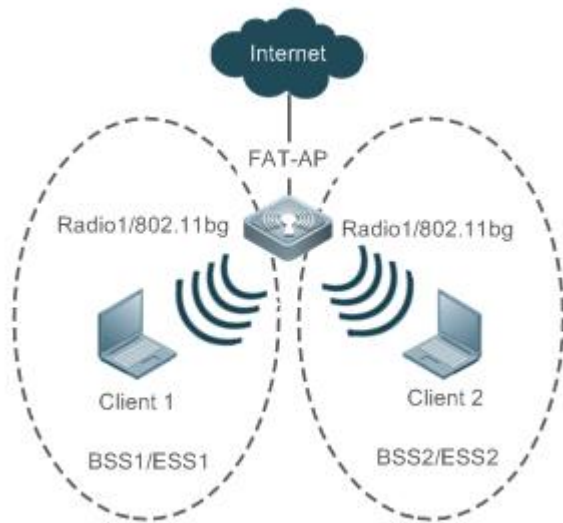

| | |
|----------------|--|
| Remarks | <p>Radio1 is the first RF interface of the FATAP.</p> <p>Client1 and Client2 are wireless clients.</p> <p>The FATAP and Client1 comprise BSS1 and BSS1 belongs to ESS1.</p> <p>The FATAP and Client2 comprise BSS2 and BSS2 belongs to ESS2.</p> |
|----------------|--|

Deployment

- Run the IEEE802.11 protocol on the FAT AP, Client1 and Client2 to implement access and authentication of the wireless clients.
- Configure and manage the FAT AP.
- Run 802.11a or 802.11b on the FAT AP because the FAT AP provides only Radio 1.
- Create two WLANs on the FAT AP, namely, ESS1 and ESS2. Both the two WLANs are mapped to Radio1, namely BSS1 and BSS2.

1.2.3 Configuring Single ESS and Multiple BSSs (Multiple RF Bands)

Scenario

A FAT AP may support more than one band in a single logic management domain. All bands support the same ESS, but belong to different BSSs; therefore, their physical coverage ranges are different. This networking also applies to scenarios where both 802.11a and 802.11b/g need to be supported.

As shown in Figure 1-3, Client1 accesses the 2.4 GHz band, and Client2 accesses the 5 GHz band. Client1 and Client2 belong to the same ESS1, but Client 1 belongs to BSS1 and Client2 belongs to BSS2.

Figure 1-3

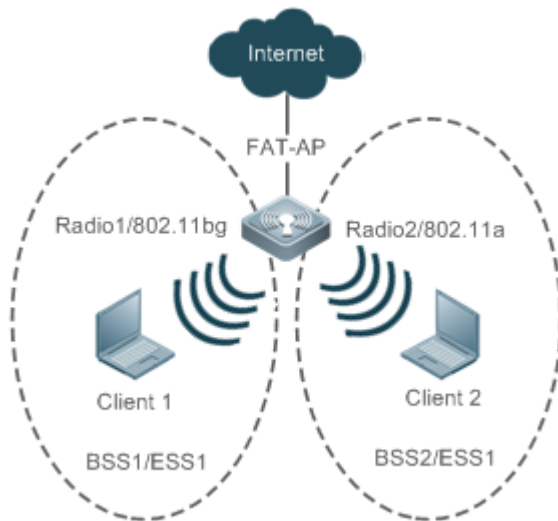

| | |
|----------------|---|
| Remarks | <p>Radio1 is the first RF interface of the FAT AP.</p> <p>Radio2 is the second RF interface of the FAT AP.</p> <p>Client1 and Client2 are wireless clients.</p> <p>The FAT AP and Client1 comprise BSS1 and BSS1 belongs to ESS1.</p> <p>The FAT AP and Client2 comprise BSS2 and BSS2 belongs to ESS1.</p> |
|----------------|---|

Deployment

- Run the IEEE802.11 protocol on the FAT AP, Client1 and Client2 to implement access and authentication of the wireless clients.
- Configure and manage the FAT AP.
- The FAT AP provides two RF interfaces, namely, Radio1 and Radio2. Run 802.11b for Radio 1 and run 802.11a for Radio 2.
- Create two WLANs on the FAT AP, namely, ESS1 and ESS2. ESS1 is mapped to Radio1, namely, BSS1; ESS2 is mapped to Radio2, namely, BSS2.

1.3 Features

Basic Concepts

WLAN

A Wireless Local Area Network (WLAN) is a network that connects computers by using the wireless communication technology to implement communication and resource sharing. The essential feature of a WLAN is that it does not connect computers to a network by using communication cables, but using a wireless mode. In this way, a WLAN makes network setup and terminal mobility more flexible.

AC

Access Category (AC): An AC is the label of a universal EDCA parameter set. Different ACs have different priorities for accessing media due to different EDCA parameters.

↘ AP

Access Point (AP): An AP is used for wireless terminals to access a wired network, which is the communication bridge between the wireless terminals and wired network.

↘ STA

Wireless users: users using wireless terminals for accessing a network.

↘ BSS

The coverage range of an AP. Each BSS is identified by a BSSID. The simplest WLAN comprises one BSS and all wireless clients are within the same BSS. If these wireless clients are assigned the same rights, they can communicate with each other.

↘ ESS

Extended Service Set (ESS): comprises all clients within the same logical management domain. One ESS may contain multiple BSSs.

↘ SSID

Service Set Identifier (SSID), also referred to as ESSID: It is used to distinguish different networks, that is, identifying an ESS. An SSID contains a maximum of 32 characters. A WNIC configured with different SSIDs can access different networks. SSIDs are usually broadcasted by an AP or a wireless router. The scanning function delivered with the XP can be used to view SSIDs within the current area. In consideration of security, SSIDs may not be broadcasted. In this case, users need to manually set SSIDs to access corresponding networks. To be simple, an SSID is the name of a WLAN. Only computers with the same SSID can communicate with each other.

Overview

| Feature | Description |
|--|---|
| Creating a WLAN | Creates a WLAN and associate the WLAN to an SSID. |
| Mapping a WLAN to Wireless Devices | Specifies a virtual wireless device used by the WLAN. |
| Deploying and Optimizing the Network | Sets the RF parameters of the wireless device to deploy and optimize the wireless network. |
| Setting E-bag Parameters | Sets the e-bag parameters of the AP and associated RF interfaces. |
| Configuring Link Integrity Check | Enables or disables the link integrity check function. |
| Configuring a WLAN by Using the One-Key Mode | Provides the one-key WLAN configuration function for an empty device to implement fast configuration. |

1.3.1 Creating a WLAN

Before a FAT AP provides wireless access services for wireless clients, a WLAN must be created first.

Working Principle

↘ Planning WLAN Subnets

In a wireless network, users can divide the network into multiple WLAN subnets by creating WLANs and specify the functions and attributes of the WLANs in the WLAN configuration mode, thus providing different network services for wireless users.

↘ Associating an SSID

When a WLAN is created, an SSID must be associated with the WLAN. An SSID is only the name of a network service domain. One SSID may map to one or more WLANs.

↘ Broadcasting SSIDs

In a WLAN, the AP regularly broadcasts the SSID information to announce existence of the wireless network. An STA can discover a WLAN by searching for its SSID using a WNIC. To prevent illegal users from discovering WLANs by means of SSID broadcasting and establishing illegal connections, the SSID broadcasting can be disabled.

↘ Multicast Rate

A multicast rate is a rate used when an AP sends multicast packets to STAs in a WLAN. The higher the multicast rate, the higher the network performance, the higher requirement for the signal-noise ratio, and the higher the multicast packet loss ratio of wireless terminals. On the other hand, the lower the multicast rate, the lower the network performance, the lower requirement for the signal-noise ratio, and the lower the multicast packet loss ratio of wireless terminals.

1.3.2 Mapping a WLAN to Wireless Devices

After a WLAN is created, the WLAN needs to use wireless devices for wireless transmission.

Working Principle

↘ Configuring a dot11radio Subinterface

A dot11radio subinterface is a virtual wireless device, whose functions are basically the same as those of a physical wireless device.

↘ Configuring a VLAN Encapsulated by a dot11radio Subinterface

VLAN attributes are needed when wireless packets of wireless devices are transferred in a wired network.

↘ Mapping a WLAN ID to a dot11radio Subinterface

Specify the virtual wireless devices to be used by a WLAN for wireless transmission.

1.3.3 Deploying and Optimizing the Network

After a WLAN is mapped to a wireless device, the RF parameters of the wireless device need to be set for deploying and optimizing the network.

Working Principle

▾ Configuring the DTIM Period

Delivery Traffic indication Map (DTIM) is a flag bit in a beacon frame, which indicates the interval at which an AP sends broadcast frames or multicast frames. When a wireless terminal is in the sleepmode, the AP automatically caches the data received within the DTIM interval. When the DTIM interval expires, the AP sends the cached data to the wireless terminal.

The DTIM period is a certain number of beacon frames that are sent. If the DTIM period is set to 3, the AP sends broadcast frames or multicast frames after every three beacon frames are sent.

▾ Configuring the U-APSD Power-Saving Mode

U-APSD is an improvement on the original power-saving mode. During association, a client can specify the triggering attribute for some ACs, the sending attribute for some ACs, and the maximum number of packets that can be sent after triggering. The triggering and sending attributes can also be modified when the connection admission control is used to create a stream. After a client enters the sleep mode, packets of the ACs with the sending attribute sent to the client are cached in the sending cache queue. The client needs to send packets of the ACs with the triggering attribute to obtain packets in the sending cache queue. After receiving triggering packets, the AP sends the packets in the sending queue based on the number of sending packets determined during access. The ACs without the sending attribute still use the conventional modes defined in 802.11 for storage and transmission.

▾ Configuring A-MPDU Aggregation

The 802.11n standard uses the A-MPDU aggregation frame format. One A-MPDU frame is aggregated from multiple MPDU frames, in which only one PHY header is retained while all the other PHY headers are deleted. In this way, the A-MPDU frame format reduces the additional information in PHY headers of each MPDU to be transmitted, as well as the number of ACK frames, thus reducing the load on the protocol and effectively improving the network throughput.

▾ Transmission Standards

802.11 is an industrial standard defined by IEEE for WLAN communication. With continuous supplementation and improvement of this standard, the 802.11X standard series are derived. The standard series comprise 802.11b\g\n, which are described as follows:

1. 802.11b

This standard operates at the 2.4 GHz band, provides the highest data transmission rate of 11 Mbit/s, or reduces the transmission rate to 5.5, 2, or 1 Mbit/s as required.

2. 802.11a

This standard operates at the 5 GHz band, provides the highest data transmission rate of 54 Mbit/s, or reduces the transmission rate to 48, 36, 24, 18, 12, 9 or 6 Mbit/s as required.

3. 802.11g

This standard operates at the 2.4 GHz band, provides the highest data transmission rate of 54 Mbit/s, or reduces the transmission rate to 48, 36, 24, 18, 12, 9 or 6 Mbit/s as required. Devices supporting 802.11g are backward-compatible with 802.11b.

4. 802.11n

This standard operates both at 2.4 GHz and 5 GHz bands, and provides the highest data transmission rate of 600 Mbit/s. Devices supporting 802.11n are backward-compatible with 802.11a/b/g.

↘ MCS

The RF rate of 802.11n is configured through the index of Modulation and Coding Scheme (MCS). The MCS table is a representation form in which 802.11n expresses the communication rate of a WLAN. MCS uses the factors that affect communication rates as the columns and the MCS indexes as the rows to form a rate table. Therefore, each MCS index corresponds to physical transmission rates under a group of parameters. For complete description about the MCS rate table, see *IEEE P802.11n D2.00*.

↘ Configuring the Range of Wireless Users Accessing an AP

An STA searches for APs by means of active scanning or passive scanning.

- Active scanning: An STA sends a Probe Request frame to an AP for access. The AP verifies the validity of the request and then sends a Probe Response frame.
- Passive scanning: An AP regularly broadcasts beacon frames. The STA attempts to access the AP after monitoring the beacon frames.

To control the network coverage of an AP and improve the transmission quality of wireless signals, you may limit STAs that can access the AP. Firstly, control the range of beacon frames broadcasted by the AP to reduce access of remote STAs. Secondly, control the minimum value of RSSI when STAs access the AP. If the RSSI of a request frame received from an STA is smaller than the minimum value, the STA cannot access the AP. Thirdly, control the minimum value of RSSI when STA data is transmitted. When the RSSI of a data frame received from an STA is smaller than this value, the STA is kicked off so that the STA can access an AP with better wireless signals.

↘ Configuring STA Aging

When an STA accesses a WLAN, the system automatically sets the aging time for the STA. If no information is received from this STA within the aging time, it is assumed that the STA has left the WLAN and the system deletes the STA from the network.

↘ Configuring Wireless Channels

A wireless channel is a medium channel for transmitting RF signals between an AP and STA. Different countries and bands support different channels. In China, the 2.4 GHz band can be configured with 13 channels (channels 1, 2, 3...and 13); the 5 GHz band can be configured with 24 channels (channels 36, 40, 44, 48, 52, 56, 60, 64, 100, 104, 108, 112, 116, 120, 124, 128, 132, 136, 140, 149, 153, 157, 161 and 165). At the 2.4 GHz band, overlapped channels may cause interference for each other. To avoid conflict of wireless signals, it is recommended that non-overlapped channels (such as channels 1, 6, and 11) be configured. At the 5 GHz band, the 24 channels are not overlapped and do not cause interference for each other.

↘ Configuring Packet Fragmentation

To improve the success ratio of transmission, the IEEE 802.11 MAC protocol allows to fragment packets for transmission. Fragmenting packets according to fragmentation thresholds can reduce the chance of interference and reduce bandwidth waste even upon re-transmission.

↘ RTS/CTS

To avoid signal conflict that causes data transmission failure, the IEEE 802.11 MAC protocol provides the Request To Send/Clear To Send (RTS/CTS) handshake protocol. Assuming that STA A needs to send data to STA B, STA A first sends an RTS frame to STA B. If STA B allows STA A to send the data, STA B sends a CTS frame to STA A. After receiving the CTS frame, STA A starts sending data to STA B. If multiple STAs need to send RTS frames to the same STA to request for data sending, only STAs that receive CTS frames can send data, and STAs that do not receive CTS frames suffer from channel conflict by default and can send RTS frames after a period of time.

If each STA performs RTS/CTS handshake before sending data each time, excessive RTS frames may occupy channel bandwidth, the user can set a RTS threshold to specify the frame length of data for sending. If the frame length of data sent by an STA is smaller than the set RTS Threshold, RST/CTS handshake does not need to be performed.

↘ Beacon

In a WLAN, an AP regularly sends beacon frames. A beacon frame controls information about this AP. STAs can discover the WLAN by receiving beacon frames.

↘ Configuring the Preamble Type

A preamble is a set of bits in the header of a packet, used to synchronize transmission signals between the sending and receiving ends. The user can configure preamble type (long or short) supported by an AP. The time for transmitting frames with long preamble is long and the time for transmitting frames with short preamble is short.

↘ Configuring the Timeslot Type

In a WLAN, to avoid channel contention caused by multiple STAs that send data at the same time, the STAs need to check whether channels are idle before sending data. If detecting that a channel is idle, an STA does not send data immediately but waits for a backoff time. A backoff time is a random integer multiple of a slot time (an operation time unit in the MAC protocol). Assuming that a random value is 3, the system automatically decreases the value by 1 after each slot time. The STA starts sending data when the value is equal to 0. Therefore, reducing slot time can reduce the overall backoff time and thus increase network throughput.

↘ Configuring the Channel Bandwidth

802.11n binds two bandwidths of 20 MHz into one bandwidth of 40 MHz. In actual operation, the bandwidth of 40 MHz can be used as two bandwidths of 20 MHz (one primary bandwidth and one secondary bandwidth). During data sending and receiving, the two bandwidths can be used as one bandwidth of 40 MHz or two separate bandwidths of 20 MHz. In this way, the rate can be doubled, which can improve the throughput of a WLAN.

↘ Configuring the Protection Interval

802.11n provides a mechanism for shortening the protection interval and enabling a short protection interval. The protection interval is shortened from 0.8 μ s to 0.4 μ s.

802.11ax provides three protection intervals: 0.8 μ s, 1.6 μ s, and 3.2 μ s. A longer protection interval is used for longer-distance outdoor data transmission.

↘ Configuring the Country Code

A country code is used to identify a country where radio frequencies reside. The bands, channels, and power vary with country codes. Before configuring an AP, it is required to specify the country code supported by this AP. If the configured country code changes, the corresponding bands, channels and power also change.

↘ **Configuring the Receiving and Transmitting Modes of Antennas**

An AP uses different quantities of antennas for data receiving and transmitting. In this way, the AP can transmit signals in the double spatial stream mode or three spatial stream mode over 802.11n, thus improving the data transmission performance of the AP.

↘ **Configuring an Internal Antenna and External Antenna**

An internal antenna is an antenna that is integrated inside the enclosure of an AP. An external antenna is an antenna that can be connected through the reserved hardware interface of an AP. Under the same transmission power, an external antenna provides a longer distance of transmission than an internal antenna.

↘ **Omnidirectional Antenna and Directional Antenna**

An omnidirectional antenna radiates equally in all directions. A directional antenna radiates in specific directions with a cone-shaped radiation range.

↘ **Configuring the Allowable Longest Distance Between an RF Interface of an AP and a Wireless Transmission Peer**

Wireless signals are transmitted in space at the optical speed. The longer distance between an RF interface of an AP and a wireless transmission peer, the longer time needed for transmitting wireless packets in space, and the longer the timeout duration needed for the AP to wait for ACK and CTS frames to be received. Therefore, it is necessary to adjust the timeout duration according to the distance between the RF interface of the AP and the wireless transmission peer; otherwise, wireless data transmission cannot be performed. However, the timeout duration cannot be excessively long; otherwise, the excessive timeout duration may cause air interface resource waste when the AP does not receive ACK and CTS frames.

↘ **mcell**

The Mcell function reduces the receiving sensitivity or ensures the air interface concurrent transmission effect in dense deployment scenarios by disabling the radio low noise amplifier (LNA).

1.3.4 Setting E-bag Parameters

Set the e-bag parameters of the AP and associated RF interfaces.

Working Principle

In a scenario using e-bag, it is often necessary to configure some commands to achieve better experience. The one-key e-bag network optimization command can be used for fast configuration.

↘ **AMPDU**

A-MPDU aggregation.

↳ LDPC

Low Density Parity Check (LDPC) is a type of excellent linear error correction code that is easy to implement and with low system complexity. LDPC is a Forward Error Correction (FEC) coding technology which can increase the coding reliability and coding gain. This technology was developed at the beginning of 1960s. It can be used to transmit information among noisy frequencies with amounts of background or damaged content. When being used in frequencies with seriously noisy interference, this technology can significantly reduce the risk of information losses. However, a few terminals are not compatible with LDPC, which causes packet losses.

↳ STBC

Space Time Block Coding (STBC) is a coding technique in wireless communication that improves data transmission reliability by using time and space diversities when multiple duplicates of data are transmitted at different moments and through different antennas. However, some terminals cannot be effectively compatible with STBC.

↳ Configuring the Number of AMPDU Software Re-transmission Times

The purpose of configuring the number of AMPDU software re-transmission times is to avoid sub-frame loss in wireless transmission. The larger the number of AMPDU software re-transmission times, the lower the probability of sub-frame loss. However, excessive re-transmission times may cause increase of air interface load and decrease of real-time performance of other packets in the air. To avoid packet loss when the sub-frame loss probability is high, you can set the number of AMPDU software re-transmission times to a greater value.

↳ AMPDU-RTS

The RTS protection for AMPDU can avoid AMPDU packet conflict at air interfaces due to hidden nodes, which may cause waste of air interface resources. However, RTS interaction consumes air interfaces; therefore, this function may cause negative effect in most application scenarios and is disabled by default. The RTS protection for AMPDU needs to be enabled only when the waste of air interface resources caused by hidden nodes is greater than that caused by RTS interaction.

1.3.5 Configuring Link Integrity Check

As a wireless access device, an AP plays a role similar to a part of the physical layer and MAC. Generally, an AP does not provide the switch function. Regarding the hardware structure, a FAT AP or FIT-AP has only one uplink wired link, which is the data channel for all accessed STAs. If this uplink wired link is broken due to a fault, all STAs that access this AP cannot connect to an external network.

However, when the uplink wired link is broken, STAs cannot detect the problem and take an action immediately, causing that the STAs cannot be reconnected to the network for a long time.

Link integrity check is intended to solve this problem.

Working Principle

The link integrity check function checks the uplink wired link on the AP continually. When the link is broken, this function immediately disables the RF interfaces on the AP to stop the AP access service. STAs associating with this AP are forced offline and have to select other normal APs for network access.

After the uplink wired link of the AP recovers, the link integrity check function enables the RF interfaces of the AP to recover the AP access service.

The link integrity check is required to disable the RF interfaces of an AP when the unique uplink link of the AP is broken and the AP cannot provide access service for STAs any longer. In this case, it is better to force the STAs offline than enabling them to continually associate because they can select other APs for access.

1.3.6 Configuring a WLAN by Using the One-Key Mode

The one-key WLAN configuration function is provided to implement fast configuration for an empty device.

Working Principle

↘ autowifi

Configuration on an AP:

- (1) VLAN planning: VLAN 10 is used as the VLAN for STAs on the AP.
- (2) Address pool: The 192.168.110.0 segment is used as the STA address pool on a FAT AP. The IP address of bvi 1 is 192.168.110.1.
- (3) WLAN configuration: autowifi_XXXX is used, where the last four characters are the last four characters of the equipment's MAC address. wlan-id 1 is used.
- (4) Security: WPA2 is used for encryption by default. The password is autowifi.
- (5) wlan-vlan mapping: VLAN 10 is encapsulated and wlan-id 1 are configured on the RF interfaces of the AP.
- (6) Service: the DHCP service is enabled.

1.3.7 Cancelling Power Supply Limits

For APs that need to be powered via Power over Ethernet Plus (PoE+), if the PoE+ mode cannot be agreed on via negotiation between an AP and a PoE+ device, the power supply limits can be cancelled and the AP can work at the maximum power capability.

Working Principle





When the negotiated power supply limit is 15.4 W, configure the **poe-unlimit** command to cancel power supply limits.

 Ensure that the power supply device meets the maximum power consumption requirements of the AP to be powered when using this command. Otherwise, the AP may restart frequently. Exercise caution when configuring this command.





 AP840-I supports the PoE power negotiation for PD devices.

1.4 Configuration

| Configuration | Description and Command |
|---------------|-------------------------|
|---------------|-------------------------|

| Configuration | Description and Command | |
|---|---|--|
| Configuring a WLAN |  (Mandatory) It is used to configure an SSID. | |
| | ssid | Configures an SSID. |
| |  (Optional) It is used to configure whether to broadcast SSIDs. | |
| | broadcast-ssid | Configures whether to broadcast SSIDs. |
| |  (Optional) It is used to configure the multicast rate. | |
| | mcast-rate | Configures the multicast rate. |
| Configuring a dot11radio Subinterface |  (Mandatory) It is used to create a dot11radio subinterface and configure the attributes of the dot11radio subinterface. | |
| | encapsulation | Configures the VLAN encapsulated by the dot11radio subinterface. |
| | wlan-id | Configures the WLAN ID of the mapped dot11radio subinterface. |
| Configuring RF Parameters |  (Optional) It is used to configure RF parameters. | |
| | beacon dtim-period | Configures the DTIM period. |
| | apsd | Enables/disables the U-APSD power-saving mode. |
| | ampdu | Enables/disables the A-MPDU aggregation mode. |
| | rate-set 11a | Configures the 11a rate set. |
| | rate-set 11b | Configures the 11b rate set. |
| | rate-set 11g | Configures the 11g rate set. |
| | rate-set 11n | Configures the 11n rate set. |
| | rate-set 11ac | Configures the 11ac rate set. |
| | rate-set 11ax | Configures the 802.11ax rate set. |
| | mcast-rate | Configures the multicast rate. |
| | power local | Configures the transmit power. |
| | sta-limit | Configures the limit on the STA quantity based on an RF interface. |
| | 11asupport | Configures whether to support 11a. |
| | 11bsupport | Configures whether to support 11b. |
| | 11gsupport | Configures whether to support 11g. |
| | 11nsupport | Configures whether to support 11n. |
| | 11acsupport | Configures whether to support 11ac. |
| | 11axsupport | Configures whether to support 802.11ax. |
| response-rssi | Configures the minimum value of RSSI for STA access. | |

| Configuration | Description and Command | |
|--|--|---|
| | assoc-rssi | Configures the minimum RSSI that keeps STA access. |
| | coverage-area-control | Configures the transmit power of management frames. |
| | sta-idle-timeout | Configures the STA idle time. |
| | channel | Configures channels. |
| | fragment-threshold | Configures the fragment threshold. |
| | rts threshold | Configures the RTS threshold. |
| | beacon period | Configures the beacon frame period. |
| | short-preamble | Configures enabling/disabling of the short preamble. |
| | slottime | Configures enabling/disabling of the short slot time. |
| | chan-width | Configures the channel bandwidth. |
| | short-gi | Configures enabling/disabling of short prevention interval. |
| | ofdma | Enables OFDMA. |
| | radio-type | Configures the radio type a/b. |
| | country-code | Configures the country code. |
| | antenna receive | Configures the receive mode of an antenna. |
| | antenna transmit | Configures the transmit mode of an antenna. |
| | antenna type | Configures an omnidirectional antenna or a directional antenna. |
| | external-antenna enable | Enables an external antenna and disables an internal antenna. |
| | peer-distance | Configures the allowable longest distance between an AP and a wireless transmission peer. |
| | mcell | Enables the Mcell function. |
| mu-mimo | Configures multi-user multiple-input multiple-output (MU-MIMO) of a radio. | |
| Configuring E-bag Parameters |  (Optional) It is used to set e-bag parameters. | |
| | ampdu-retries | Configures the number of AMPDU software re-transmission times. |
| | ampdu-rts | Configures whether to enable the RTS protection for AMPDU aggregation packets. |
| | eth-schd | Configures the number of Ethernet packets that can be received by an AP at a time. |
| | ldpc | Configures whether to support LDPC. |

| Configuration | Description and Command | |
|--|--|--|
| | stbc | Configures whether to enable STBC. |
| | ebag | Configures e-bag network optimization by using the one-key mode. |
| Configuring the Link Integrity Check Function |  (Mandatory) It is used to enable the link integrity check function. | |
| | link-check enable | Enables the link integrity check function. |
| Configuring a WLAN by Using the One-Key Mode |  (Optional) It is used to perform one-key WLAN configuration. | |
| | autowifi | Performs one-key WLAN configuration. |
| Configuring the Maximum Number of STAs on a Fat AP |  (Optional) It is used to configure the maximum number of STAs on a fat AP. | |
| | sta-limit | Configures the maximum number of STAs on a fat AP. |
| Cancelling Power Supply Limits |  (Optional) It is used to cancel power supply limits. | |
| | poe-unlimit | Cancels power supply limits. |

1.4.1 Configuring a WLAN

Configuration Effect

- Create a WLAN.
- Configure attributes of the WLAN.

Notes

- FAT APs support this configuration.

Configuration Steps

📌 Creating a WLAN

- For a FAT-AP to provide WLAN service, you must create a WLAN. Run the **dot11 wlan** command to create or delete a WLAN.
- If there are no special requirements, you can perform this configuration in the global configuration mode of the AP equipment.

| | |
|---------------------|---------------------------------------|
| Command | dot11 wlan <i>wlan-id</i> |
| Parameter | <i>wlan-id</i> : specifies a WLAN ID. |
| Description | |
| Defaults | - |
| Command Mode | Global configuration mode |
| Usage Guide | - |

↘ Configuring an SSID

- For a FAT-AP to provide WLAN service, you must configure an SSID. Run the **ssid** command to configure the SSID of a specified WLAN.
- If there are no special requirements, you can perform this configuration in the WLAN global configuration mode of the AP equipment.

| | |
|------------------------------|--|
| Command | ssid <i>ssid-string</i> |
| Parameter Description | <i>ssid-string</i> : specifies an SSID string. |
| Defaults | - |
| Command Mode | WLAN configuration mode |
| Usage Guide | - |

↘ Configuring Whether to Broadcast SSIDs

- Optional.
- If there are no special requirements, you can perform this configuration in the WLAN configuration mode of the AP equipment.
- If it is set to broadcast SSIDs, the AP regularly broadcasts SSID information. STAs use WNICs to search for the SSIDs and discover the networks. If it is set not to broadcast SSIDs, the AP does not regularly broadcast SSID information. STAs cannot find the SSIDs by using WNICs. In this case, SSIDs must be manually set on the STAs so that they can access the corresponding network.

| | |
|------------------------------|---|
| Command | broadcast-ssid no broadcast-ssid |
| Parameter Description | no : specifies to hide SSIDs. |
| Defaults | SSIDs are broadcasted. |
| Command Mode | WLAN configuration mode |
| Usage Guide | - |

↘ Configuring the Multicast Rate

- Optional.
- If there are no special requirements, you can perform this configuration in the WLAN configuration mode of the AP equipment.
- The higher the multicast rate, the higher the network performance, the higher requirement for the signal-noise ratio, and the higher the multicast packet loss ratio of wireless terminals. On the other hand, the lower the multicast rate, the lower the network performance, the lower requirement for the signal-noise ratio, and the lower the multicast packet loss ratio of wireless terminals.

| | |
|---------------------|--|
| Command | mcast-rate <i>mcast-num</i> |
| Parameter | <i>mcast-num</i> : indicates the WLAN multicast rate. The user can set the multicast rate to 1 Mbit/s, 6 Mbit/s, 11 Mbit/s, 24 Mbit/s and 54 Mbit/s. |
| Description | |
| Defaults | 24Mbit/s |
| Command Mode | WLAN configuration mode |
| Usage Guide | A multicast rate is effective only for the current AP band. If the multicast rate is not supported by the current band, the default rate is used. |

▾ Configuring the Maximum Number of STAs in a WLAN

- Optional.
- The maximum number of STAs is configured on an AP in WLAN configuration mode.
- When the number of STAs associated with a WLAN reaches the limit, new STAs cannot access this WLAN.

| | |
|---------------------|---|
| Command | sta-limit <i>num</i> no sta-limit |
| Parameter | <i>num</i> : Indicates the maximum number of STAs that can access a WLAN. |
| Description | |
| Defaults | The number of STAs that can access a WLAN is not limited by default. |
| Command Mode | WLAN configuration mode |
| Usage Guide | N/A |

Verification

- Run the **show running-config** command to verify the configurations of a WLAN.

Configuration Example

▾ Configuring a WLAN

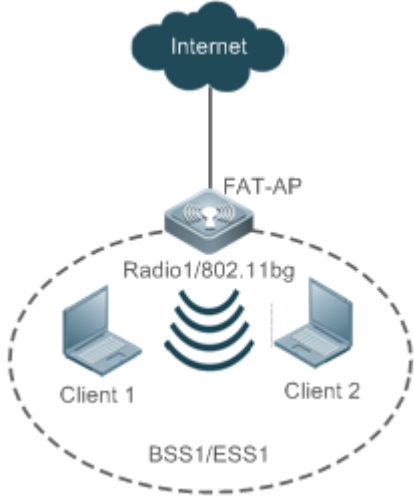
| | |
|---------------------------------------|--|
| <p>Scenario Figure 1-4</p> |  |
| <p>Configuration Steps</p> | <ul style="list-style-type: none"> ● Create a WLAN whose ID is 1 on the AP. ● Configure the SSID of WLAN 1 to fat_ap on the AP. ● Enable broadcasting of the SSID of WLAN 1 on the AP. ● Configure the multicast rate of WLAN 1 to 6 Mbit/s on the AP. |
| <p>FAT AP</p> | <pre>Ruijie#config Ruijie(config)#dot11 wlan 1 Ruijie(dot11-wlan-config)#ssid fat_ap Ruijie(dot11-wlan-config)#broadcast-ssid Ruijie(dot11-wlan-config)#mcast-rate 6</pre> |
| <p>Verification</p> | <p>After the user configures a WLAN, verify the WLAN based on displayed WLAN configurations.</p> <ul style="list-style-type: none"> ● Run the show running-config command to verify the configurations of a WLAN. |
| | <pre>Ruijie#show running-config ! dot11 wlan 1 mcast-rate 6 broadcast-ssid ssid fat_ap !</pre> |

Common Errors

N/A

1.4.2 Configuring a dot11radio Subinterface

Configuration Effect

- Create a dot11radio subinterface.
- Configure attributes of the dot11radio subinterface.

Notes

- FAT APs support this configuration.

Configuration Steps

📌 Creating a dot11radio Subinterface

- For a FAT-AP to provide WLAN service, you must configure a dot11radio subinterface. Run the **interface dot11radio** command to create or delete the dot11radiosubinterface.
- If there are no special requirements, you can perform this configuration in the global configuration mode of the AP equipment.

| | |
|------------------------------|---|
| Command | interface dot11radio <i>interface-num</i> |
| Parameter Description | <i>interface-num</i> : specifies the number of the dot11radio subinterface. |
| Defaults | - |
| Command Mode | Global configuration mode |
| Usage Guide | - |

📌 Configuring the VLAN Encapsulated by a dot11radio Subinterface

- Mandatory.
- For a FAT-AP to forward data normally, you must configure the VLAN attributes encapsulated by the dot11radio subinterface. Otherwise, STAs may not communicate normally even though they can access the VLAN. Run the **encapsulation dot1Q** command to configure the VLAN attributes of the specified dot11radio subinterface.
- If there are no special requirements, you can perform this configuration in the dot11radio subinterface configuration mode of the AP equipment.

| | |
|------------------------------|--|
| Command | encapsulation dot1Q <i>vlan-id</i> |
| Parameter Description | <i>vlan-id</i> : specifies a VLAN ID or VLAN GROUP ID. |
| Defaults | - |
| Command Mode | dot11radio subinterface configuration mode |
| Usage Guide | - |

📌 Configuring the WLAN ID Mapped to a dot11radio Subinterface

- For a FAT-AP to provide WLAN service, you must configure the WLAN ID that is mapped to a dot11radio interface. Run the **broadcast-ssid** command to configure whether to broadcast an SSID.
- If there are no special requirements, you can perform this configuration in the dot11radio sub-interface subinterface configuration mode of the AP equipment.

| | |
|---------------------|--|
| Command | wlan-id <i>wlan-id</i> |
| Parameter | <i>wlan-id</i> : specifies a WLAN ID. |
| Description | |
| Defaults | - |
| Command Mode | dot11radio subinterface configuration mode |
| Usage Guide | - |

Verification

- Run the **show running-config** command to verify the configurations of a WLAN.

Configuration Example

▾ **Configuring dot11radio Subinterface**

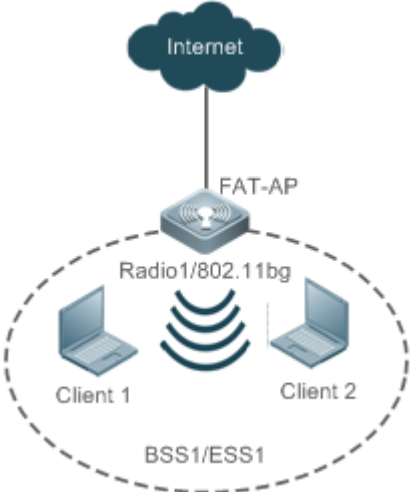
| | |
|---------------------------------------|---|
| <p>Scenario Figure 1-5</p> |  |
| <p>Configuration Steps</p> | <ul style="list-style-type: none"> ● Create dot11radio 1/0.1 on the AP equipment. ● Configure the VLAN ID encapsulated by dot11radio 1/0.1 to 1 on the AP equipment. ● Map WLAN 1 to dot11radio 1/0.1 on the AP equipment. |
| <p>FAT AP</p> | <pre>Ruijie#config Ruijie(config)#interface dot11radio 1/0.1 Ruijie(config-subif)#encapsulation dot1Q 1 Ruijie(config-subif)#wlan-id 1</pre> |

| | |
|---------------------|--|
| Verification | <p>After configuring the dot11radio subinterface, you can verify the dot11radio subinterface based on displayed dot11radio subinterface configurations.</p> <ul style="list-style-type: none"> ● Run the show running-config command to check the configurations of the dot11radio subinterface. |
| | <pre>Ruijie#show running-config ! interface Dot11radio 1/0.1 encapsulation dot1Q 1 mcast-rate 54 wlan-id 1 !</pre> |

Common Errors

N/A

1.4.3 Configuring RF Parameters

Configuration Effect

- Configure RF parameters.

Notes

- FAT APs support this configuration.

Configuration Steps

📌 Configuring the DTIM Period

- (Optional) Run the **beacon dtim-period** command to configure the DTIM period. The value ranges from 1 to 255.
- If there are no special requirements, you can perform this configuration in the dot11radio interface configuration mode of the AP equipment.
- The longer the DTIM period, the better the power-saving effect, and the longer the downlink multicast packet delay.

| | |
|------------------------------|---|
| Command | beacon dtim-period <i>num</i> |
| Parameter Description | <i>num</i> : indicates the DTIM period, ranging from 1 to 255 in the unit of one beacon frame period. |
| Defaults | The DTIM period is at the interval of one beacon frame period. |
| Command Mode | dot11radio interface configuration mode |
| Usage Guide | - |

↘ Configuring Enabling/Disabling of the U-APSD Power-Saving Mode

- (Optional) Run the **apsd** command to configure enabling/disabling of the U-APSD power-saving mode.
- If there are no special requirements, you can perform this configuration in the dot11radio interface configuration mode of the AP equipment.
- Enabling the U-APSD power-saving mode helps reduce the delay of services requiring higher real-time performance during power management. The service time of a battery can be extended if transmission of wireless signals is disabled at most time.

| | |
|---------------------|--|
| Command | apsd { enable disable } |
| Parameter | enable: enables the U-APSD power-saving mode. |
| Description | disable: disables the U-APSD power-saving mode. |
| Defaults | The U-APSD power-saving mode is enabled. |
| Command Mode | dot11radio interface configuration mode |
| Usage Guide | - |

↘ Configuring Enabling/Disabling of the A-MPDU Aggregation Mode

- (Optional) Run the **ampdu** command to configure enabling/disabling of the A-MPDU aggregation mode.
- If there are no special requirements, you can perform this configuration in the dot11radio interface configuration mode of the AP equipment.
- Enabling the A-MPDU aggregation mode can aggregate multiple frames into one frame for transmission, which helps reduce frame headers and frame slots. In addition, reduction of frames helps reduce the overall chance of conflict.

| | |
|---------------------|---|
| Command | ampdu { enable disable } |
| Parameter | enable: enables the A-MPDU aggregation mode. |
| Description | disable: disables the A-MPDU aggregation mode. |
| Defaults | The A-MPDU aggregation mode is enabled. |
| Command Mode | dot11radio interface configuration mode |
| Usage Guide | - |

↘ Configuring the 11a Rate Set

- Optional.
- If there are no special requirements, you can perform this configuration in the dot11radio interface configuration mode of the AP equipment.
- Disabling a rate makes this rate unavailable. Disabling all rates makes STAs fail in access.

| | |
|--------------------|---|
| Command | rate-set 11a { mandatory support disable } speed |
| Parameter | mandatory: indicates whether a rate is a mandatory rate. |
| Description | support: indicates whether a rate is supported. disable: indicates whether a rate is disabled. |

| | |
|---------------------|---|
| | <i>speed</i> : specifies a rate. |
| Defaults | 6 Mbit/s, 9 Mbit/s and 12 Mbit/s are mandatory rates and all the other rates are supported rates. |
| Command Mode | dot11radio interface configuration mode |
| Usage Guide | - |

↘ Configuring the 11b Rate Set

- Optional.
- If there are no special requirements, you can perform this configuration in the dot11radio interface configuration mode of the AP equipment.
- Disabling a rate makes this rate unavailable. Disabling all rates makes 11b STAs fail in access.

| | |
|------------------------------|---|
| Command | rate-set 11b { mandatory support disable } <i>speed</i> |
| Parameter Description | mandatory : indicates whether a rate is a mandatory rate. support : indicates whether a rate is supported. disable : indicates whether a rate is disabled. <i>speed</i> : specifies a rate. |
| Defaults | 1 Mbit/s, 2 Mbit/s, 5.5 Mbit/s and 11 Mbit/s are mandatory rates. |
| Command Mode | dot11radio interface configuration mode |
| Usage Guide | - |

↘ Configure the 11g Rate Set

- Optional.
- If there are no special requirements, you can perform this configuration in the dot11radio interface configuration mode of the AP equipment.
- Disabling a rate makes this rate unavailable. Disabling all rates makes 11g STAs fail in access.

| | |
|------------------------------|---|
| Command | rate-set 11g { mandatory support disable } <i>speed</i> |
| Parameter Description | mandatory : indicates whether a rate is a mandatory rate. support : indicates whether a rate is supported. disable : indicates whether a rate is disabled. <i>speed</i> : specifies a rate. |
| Defaults | 1 Mbit/s, 2 Mbit/s, 5.5 Mbit/s and 11 Mbit/s are mandatory rates and all the other rates are supported rates. |
| Command Mode | dot11radio interface configuration mode |
| Usage Guide | - |

↘ Configuring the 11n Rate Set

- Optional.

- If there are no special requirements, you can perform this configuration in the dot11radio interface configuration mode of the AP equipment.
- The higher the mcs, the higher the available rate.

| | |
|------------------------------|--|
| Command | rate-set 11n { mcs-mandatory mcs-support } index |
| Parameter Description | mcs-mandatory: indicates whether a rate is a mandatory mcs rate. mcs-support: indicates whether a mcs rate is supported. <i>index:</i> specifies a mcs rate. |
| Defaults | The mcs is 7 for one stream, 15 for two streams, and 23 for three streams. All mandatory mcs is 0. |
| Command Mode | dot11radio interface configuration mode |
| Usage Guide | - |

↘ Configuring the 11ac Rate Set

- Optional.
- If there are no special requirements, you can perform this configuration in the dot11radio interface configuration mode of the AP equipment.
- The higher the mcs, the higher the available rate.

| | |
|------------------------------|--|
| Command | rate-set 11ac { mcs-mandatory mcs-support } index |
| Parameter Description | mcs-mandatory: indicates whether a rate is a mandatory mcs rate. mcs-support: indicates whether a mcs rate is supported. <i>index:</i> specifies a mcs rate. |
| Defaults | The mcs is 9 for one stream, 19 for two streams, and 29 for three streams. All mandatory mcs is 0. |
| Command Mode | dot11radio interface configuration mode |
| Usage Guide | - |

↘ Configuring the 802.11ax Rate Set

- Optional.
- If there are no special requirements, you can perform this configuration in the dot11radio interface configuration mode of the AP.
- The higher the MCS rate, the higher the available rate.

| | |
|------------------------------|---|
| Command | rate-set 11ax mcs-support index |
| Parameter Description | mcs-support: indicates whether an MCS rate is supported. <i>index:</i> specifies an MCS rate. |
| Defaults | Number of supported MCS rates = (Number of radio streams x 12) – 1. |
| Command Mode | dot11radio interface configuration mode |
| Usage Guide | - |

▾ Configure the Multicast Rate

- Optional.
- If there are no special requirements, you can perform this configuration in the dot11 radio interface configuration mode of the AP equipment.
- The higher the multicast rate, the higher the rate for transmitting multicast packets, the shorter the time for occupying channels, the higher the utilization of channels, but the lower the transmit success ratio when the channel quality is poor.

| | |
|------------------------------|---|
| Command | mcast-rate {1 6 11 24 54} |
| Parameter Description | 1: sets the multicast rate to 1 Mbit/s. 6: sets the multicast rate to 6 Mbit/s. 11: sets the multicast rate to 11 Mbit/s. 24: sets the multicast rate to 24 Mbit/s. 54: sets the multicast rate to 54 Mbit/s. |
| Defaults | 24Mbit/s |
| Command Mode | dot11 radio interface configuration mode |
| Usage Guide | - |

▾ Configure the Transmit Power

- Optional.
- If there are no special requirements, you can perform this configuration in the dot11 radio interface configuration mode of the AP equipment.
- The higher the transmit power, the larger the coverage range of wireless signals, the better quality the signals received by STAs, but the more power consumed by the FATAP, and the greater interference between different channels.

| | |
|------------------------------|--|
| Command | power local <i>power-value</i> |
| Parameter Description | <i>power-value</i> : indicates the transmit power, ranging from 1 to 100 in the unit of %. |
| Defaults | 100% |
| Command Mode | dot11 radio interface configuration mode |
| Usage Guide | - |

▾ Configuring the Limit on the STA Quantity based on an RF Interface

- Optional.
- If there are no special requirements, you can perform this configuration in the dot11 radio interface configuration mode of the AP equipment.
- The higher the limit on the STA quantity based on an RF interface, the more STAs that can be accessed.

| | |
|----------------|------------------------------------|
| Command | sta-limit <i>client-num</i> |
|----------------|------------------------------------|

| | |
|------------------------------|---|
| Parameter Description | <i>client-num</i> : indicates the STA quantity. Range: 1-128. |
| Defaults | The default value varies with product model. |
| Command Mode | dot11radio interface configuration mode |
| Usage Guide | - |

▾ Configuring Whether to Support 11a

- Optional.
- If there are no special requirements, you can perform this configuration in the dot11radio interface configuration mode of the AP equipment.
- If 11a is supported, 11a STAs can be accessed; otherwise, 11a STAs cannot be accessed.

| | |
|------------------------------|--|
| Command | 11asupport enable no 11asupport enable |
| Parameter Description | no : indicates that 11a is not supported. |
| Defaults | 11a STA access is supported. |
| Command Mode | dot11radio interface configuration mode |
| Usage Guide | The configuration is effective only when the RF interfaces of an AP operate at the 5 GHz band. |

▾ Configuring Whether to Support 11b

- Optional.
- If there are no special requirements, you can perform this configuration in the dot11radio interface configuration mode of the AP equipment.
- If 11b is supported, 11b STAs can be accessed; otherwise, 11b STAs cannot be accessed.

| | |
|------------------------------|--|
| Command | 11bsupport enable no 11bsupport enable |
| Parameter Description | no : indicates that 11b is not supported. |
| Defaults | 11b STA access is supported. |
| Command Mode | dot11radio interface configuration mode |
| Usage Guide | The configuration is effective only when the RF interfaces of an AP operate at the 2.4 GHz band. |

▾ Configuring Whether to Support 11g

- Optional.
- If there are no special requirements, you can perform this configuration in the dot11radio interface configuration mode of the AP equipment.

- If 11g is supported, 11g STAs can be accessed; otherwise, 11g STAs cannot be accessed.

| | |
|------------------------------|--|
| Command | 11gsupport enable no 11gsupport enable |
| Parameter Description | no: indicates that 11g is not supported. |
| Defaults | 11g STA access is supported. |
| Command Mode | dot11radio interface configuration mode |
| Usage Guide | The configuration is effective only when the RF interfaces of an AP operate at the 2.4 GHz band. |

↘ Configuring Whether to Support 11n

- Optional.
- If there are no special requirements, you can perform this configuration in the dot11radio interface configuration mode of the AP equipment.
- If 11n is supported, 11n STAs can be accessed; otherwise, 11n STAs cannot be accessed.

| | |
|------------------------------|---|
| Command | 11nsupport enable no 11nsupport enable |
| Parameter Description | no: indicates that 11n is not supported. |
| Defaults | 11n STA access is supported. |
| Command Mode | dot11radio interface configuration mode |
| Usage Guide | - |

↘ Configuring Whether to Support 11ac

- Optional.
- If there are no special requirements, you can perform this configuration in the dot11radio interface configuration mode of the AP equipment.
- If 11ac is supported, 11ac STAs can be accessed; otherwise, 11ac STAs cannot be accessed.

| | |
|------------------------------|---|
| Command | 11acsupport enable no 11acsupport enable |
| Parameter Description | no: indicates that 11ac is not supported. |
| Defaults | When an RF interface provides the 11ac capability, 11ac STA access is supported by default. |
| Command Mode | dot11radio interface configuration mode |
| Usage Guide | - |

↘ Configuring Whether to Support 802.11ax

- Optional.
- If there are no special requirements, you can perform this configuration in the dot11radio interface configuration mode of the AP.
- If 802.11ax is supported, 802.11ax STAs can access the network directly; otherwise, 802.11ax STAs can access the network via only 802.11ac or 802.11n.

| | |
|------------------------------|---|
| Command | 11axsupport enable no 11axsupport enable |
| Parameter Description | no: indicates that 802.11ax is not supported. |
| Defaults | When an RF interface provides the 802.11ax capability, 802.11ax is disabled by default. |
| Command Mode | dot11radio interface configuration mode |
| Usage Guide | - |

↘ Configuring the Minimum Value of RSSI for STA Access

- Optional.
- If there are no special requirements, you can perform this configuration in the dot11radio interface configuration mode of the AP equipment.
- The lower the RSSI for STA access, the lower the RSSI for STAs that are allowed for access, and often the longer the distance from STAs that are allowed for access to a FAT AP.

| | |
|------------------------------|---|
| Command | response-rssi <i>rss-value</i> |
| Parameter Description | <i>rss-value:</i> indicates the minimum RRIS for STA access, ranging from 0 to 100 in the unit of dB. |
| Defaults | The minimum RSSI for STA access is 0, which indicates that all STAs are allowed for access regardless of their RSSI values. |
| Command Mode | dot11radio interface configuration mode |
| Usage Guide | - |

↘ Configuring the Minimum RSSI That Keeps STA Access

- Optional.
- If there are no special requirements, you can perform this configuration in the dot11radio interface configuration mode of the AP equipment.
- The lower the RSSI that keeps STA access, the lower the RSSI for STAs whose access can be kept, and often the longer the distance from STAs that are allowed for access to a FAT AP.

| | |
|------------------------------|---|
| Command | assoc-rssi <i>rss-value</i> |
| Parameter Description | <i>rss-value:</i> indicates the minimum RRIS that keeps STA access, ranging from 0 to 100 dB. |

| | |
|---------------------|---|
| Defaults | The minimum RSSI that keeps STA access is 0, which indicates that the access of all STAs is kept regardless of their RSSI values. |
| Command Mode | dot11radio interface configuration mode |
| Usage Guide | - |

▾ Configuring the Transmit Power of Management Frames

- Optional.
- If there are no special requirements, you can perform this configuration in the dot11radio interface configuration mode of the AP equipment.
- The higher the transmit power (except for 0) for management frames, the larger the STA range of a FAT AP, and often the longer the distance from STAs that are allowed for access from a FATAP.

| | |
|------------------------------|--|
| Command | coverage-area-control <i>power-value</i> |
| Parameter Description | <i>power-value</i> : indicates the transmit power for management frames, ranging from 0 to 32 dBm. |
| Defaults | The transmit power for management frames is 0, which indicates that no transmit power is configured for management frames. |
| Command Mode | dot11radio interface configuration mode |
| Usage Guide | - |

▾ Configuring the STA Idle Time

- Optional.
- If there are no special requirements, you can perform this configuration in the dot11radio interface configuration mode of the AP equipment.
- The shorter the STA idle time, the easier STAs leave a WLAN due to lower traffic.

| | |
|------------------------------|---|
| Command | sta-idle-timeout <i>seconds</i> |
| Parameter Description | <i>seconds</i> : indicates the STA idle time, ranging from 60 to 86400 seconds. |
| Defaults | The STA idle time is 300 seconds. |
| Command Mode | dot11radio interface configuration mode |
| Usage Guide | - |

▾ Configuring Channels

- (Optional) Run the **channel** command to configure channels.
- If there are no special requirements, you can perform this configuration in the dot11radio interface configuration mode of the AP equipment.

- At the 2.4 GHz band, overlapped channels may cause interference for each other. To avoid conflict of wireless signals, it is recommended that non-overlapped channels (such as channels 1, 6, and 11) be configured. At the 5 GHz band, the 24 channels (channels 36, 40, 44, 48, 52, 56, 60, 64, 100, 104, 108, 112, 116, 120, 124, 128, 132, 136, 140, 149, 153, 157, 161 and 165) are not overlapped in HT20 and do not cause interference for each other.

| | |
|------------------------------|--|
| Command | channel <i>channel-num</i> |
| Parameter Description | <i>channel-num</i> : indicates a working channel. |
| Defaults | Channel 1 is used at the 2.4 GHz band and channel 149 is used at the 5.8 GHz band. |
| Command Mode | dot11radio interface configuration mode |
| Usage Guide | - |

▾ Configuring the Fragment Threshold

- (Optional) Run the **fragment-threshold** command to configure the fragment threshold, which must be an even number.
- If there are no special requirements, you can perform this configuration in the dot11radio interface configuration mode of the AP equipment.
- Packets from upper layers or some large management frames must be fragmented before they can be transmitted on wireless channels. Fragmented packets help to improve reliability when interference exists. By using frame fragments, STAs may control interference to affect only small frame fragments rather than large frames. By reducing data that may be interfered, frame fragments can improve the overall effective throughput. When interference exists, the smaller the fragment threshold, the higher the anti-interference capability.

| | |
|------------------------------|--|
| Command | fragment-threshold <i>threshold-value</i> |
| Parameter Description | <i>threshold-value</i> : indicates the fragment threshold, ranging from 256 to 2346 in the unit of byte. |
| Defaults | The fragment threshold is 2346 bytes. |
| Command Mode | dot11radio interface configuration mode |
| Usage Guide | The fragment threshold must be an even number. |

▾ Configuring the RTS Threshold

- Optional.
- If there are no special requirements, you can perform this configuration in the dot11radio interface configuration mode of the AP equipment.
- When co-frequency interference exists, the smaller the RTS threshold, the higher the anti-interference capability. However, the more the RTS/CTS packets, the more channels occupied by control packets, and the less the channel bandwidth available to STAs.

| | |
|------------------------------|---|
| Command | rts threshold <i>threshold-value</i> |
| Parameter Description | <i>threshold-value</i> : indicates the RTS threshold, ranging from 257 to 2347 in the unit of byte. |

| | |
|---------------------|---|
| Defaults | The RTS threshold is 2347 bytes. |
| Command Mode | dot11radio interface configuration mode |
| Usage Guide | - |

↘ Configuring the Beacon Frame Period

- Optional.
- If there are no special requirements, you can perform this configuration in the dot11radio interface configuration mode of the AP equipment.
- The smaller the beacon frame period, the more frequent beacon frames are sent, and the faster STAs discover WLANs. However, the more the beacon frames, namely, the more channels occupied by management frames, the less the channel bandwidth available to STAs. The beacon frame period should not be too long; otherwise, STAs may frequently go offline or perform detection.

| | |
|------------------------------|---|
| Command | beacon period <i>milliseconds</i> |
| Parameter Description | <i>milliseconds</i> : indicates the beacon frame period, ranging from 20 to 1000 in the unit of ms. |
| Defaults | The beacon frame period is 100 milliseconds. |
| Command Mode | dot11radio interface configuration mode |
| Usage Guide | - |

↘ Configuring Enabling/Disabling of the Short Preamble

- Optional.
- Enabling a short preamble may reduce the time for data transmission and help increase the network throughput. Preamble configuration is effective only when an AP operates at the 2.4 GHz band. At the 5 GHz band, the long preamble is used by default and the preamble cannot be configured.

| | |
|------------------------------|--|
| Command | short-preamble no short-preambl |
| Parameter Description | no : disables the short preamble. |
| Defaults | The short preamble is disabled. |
| Command Mode | dot11radio interface configuration mode |
| Usage Guide | - |

↘ Configuring Enabling/Disabling of the Short Slot Time

- Optional.
- If there are no special requirements, you can perform this configuration in the dot11radio interface configuration mode of the AP equipment.

- Enabling the short slot time can reduce the overall backoff time and thus increase the network throughput. Slot time configuration is effective only when an AP operates at the 2.4 GHz band in a non-11b network. At the 5 GHz band, the short time slot is used by default.

| | |
|---------------------|--|
| Command | slottime { long short } |
| Parameter | long : uses the long time slot. |
| Description | short : uses the short time slot. |
| Defaults | The short time slot is enabled. |
| Command Mode | dot11radio interface configuration mode |
| Usage Guide | - |

▾ Configuring the Channel Bandwidth

- Optional.
- If there are no special requirements, you can perform this configuration in the dot11radio interface configuration mode of the AP equipment.
- The higher the channel bandwidth, the more channel bandwidth available to STAs, but the fewer the channels that can be configured, and the higher the probability of interference between neighboring channels.

| | |
|---------------------|--|
| Command | chan-width { 20 40 80 } |
| Parameter | 20 : sets the channel bandwidth to 20 MHz. |
| Description | 40 : sets the channel bandwidth to 40 MHz. 80 : sets the channel bandwidth to 80 MHz. |
| Defaults | The channel bandwidth is 20 MHz. |
| Command Mode | dot11radio interface configuration mode |
| Usage Guide | - |

▾ Enabling/Disabling of Short Protection Interval

- Optional.
- If there are no special requirements, you can perform this configuration in the dot11radio interface configuration mode of the AP.
- After the short protection interval is enabled, the protection interval is reduced from 0.8 μ s to 0.4 μ s, which helps increase the network throughput.

| | |
|--------------------|--|
| Command | short-gi enable chan-width { 20 40 80 } no short-gi enable chan-width { 20 40 80 } |
| Parameter | no : disables the short protection interval. |
| Description | 20 : indicates enabling/disabling the short protection interval at the channel bandwidth of 20 MHz. 40 : indicates enabling/disabling the short protection interval at the channel bandwidth of 40 MHz. 80 : indicates enabling/disabling the short protection interval at the channel bandwidth of 80 MHz. |
| Defaults | The short protection interval is enabled at 20 MHz and 40 MHz and disabled at 80 MHz. |

| | |
|---------------------|---|
| Command Mode | dot11radio interface configuration mode |
| Usage Guide | - |

↘ Configuring the Radio Type a/b

- Optional.
- If there are no special requirements, you can perform this configuration in the dot11radio interface configuration mode of the AP equipment.
- An AP supports RF transmission at the 2.4 GHz and 5 GHz bands. The user can specify the operating band of an AP.

| | |
|------------------------------|--|
| Command | radio-type { 802.11a 802.11b } |
| Parameter Description | 802.11a: sets the radio type to 5 GHz. 802.11b: sets the radio type to 2.4GHz. |
| Defaults | A single-band AP (provides Radio 1) supports the 2.4 GHz band. For a dual-band AP, Radio 1 supports the 2.4 GHz band and Radio 2 supports the 5 GHz band. For a tri-band AP, Radio 1 supports the 2.4 GHz band, Radio 2 supports the 5 GHz band and Radio 3 supports the 5 GHz band. |
| Command Mode | dot11radio interface configuration mode |
| Usage Guide | - |

↘ Configuring the Country Code

- Optional.
- If there are no special requirements, you can perform this configuration in the global configuration mode of the AP equipment.
- A country code is used to identify a country where radio frequencies reside. The bands, channels, and power vary with country codes. Before configuring an AP, specify the country code supported by this AP. If the configured country code changes, the corresponding bands, channels and power also change.

| | | |
|------------------------------|---|----------------------|
| Command | country-code <i>country-code</i> | |
| Parameter Description | <i>country-code</i> : indicates a country code. | |
| Defaults | The country code is CN, indicating China. | |
| Command Mode | dot11radio interface configuration mode | |
| Usage Guide | The following country codes are available: | |
| | Country Code | Country |
| | AE | United Arab Emirates |
| | AU | Australia |
| | CN | China |

| | |
|----|---------------|
| DE | Germany |
| HK | Hong Kong |
| ID | Indonesia |
| IN | India |
| JP | Japan |
| KR | Korea ROC |
| MO | Macau |
| MY | Malaysia |
| PH | Philippines |
| PK | Pakistan |
| RU | Russia |
| SG | Singapore |
| TH | Thailand |
| TR | Turkey |
| US | United States |
| VN | Vietnam |

Note that Channel 14 in 2.4GHz can be configured only in 802.11b mode.

▾ Configuring the Receive Mode of an Antenna

- Optional.
- If there are no special requirements, you can perform this configuration in the dot11radio interface configuration mode of the AP equipment.
- An AP uses different quantities of antennas for data receiving. In this way, the AP can receive signals in the double spatial stream mode or three spatial stream mode over 802.11n, thus improving the data transmission performance of the AP.

| | |
|------------------------------|---|
| Command | antenna receive <i>chain-mask</i> |
| Parameter Description | <i>chain-mask</i> : indicates the antenna selection mask, ranging from 1 to 255. |
| Defaults | The quantity of antennas and the default antenna selection mask vary with product models. |
| Command Mode | dot11radio interface configuration mode |
| Usage Guide | - |

▾ Configuring the Transmit Mode of an Antenna

- Optional.
- If there are no special requirements, you can perform this configuration in the dot11radio interface configuration mode of the AP equipment.

- An AP uses different quantities of antennas for data transmitting. In this way, the AP can transmit signals in the double spatial stream mode or three spatial stream mode over 802.11n, thus improving the data transmission performance of the AP.

| | |
|------------------------------|---|
| Command | antenna transmit <i>chain-mask</i> |
| Parameter Description | <i>chain-mask</i> : indicates the antenna mask, ranging from 1 to 255. |
| Defaults | The quantity of antennas and the default antenna mask vary with product models. |
| Command Mode | dot11radio interface configuration mode |
| Usage Guide | - |

↘ Enabling an External Antenna

- Optional.
- If there are no special requirements, you can perform this configuration in the dot11radio interface configuration mode of the AP equipment.
- Under the same transmission power, an external antenna provides a longer distance of transmission than an internal antenna.

| | |
|------------------------------|---|
| Command | external-antenna enable |
| Parameter Description | - |
| Defaults | Internal antennas are enabled and external antennas are disabled. |
| Command Mode | dot11radio interface configuration mode |
| Usage Guide | - |

↘ Configuring an Omnidirectional Antenna or Directional Antenna

- Optional.
- If there are no special requirements, you can perform this configuration in the dot11radio interface configuration mode of the AP.
- Under the same transmission power, a directional antenna provides a longer distance of transmission than an omnidirectional antenna.

| | |
|------------------------------|--|
| Command | antenna type { omnidirection direction } |
| Parameter Description | omnidirection : indicates the omnidirectional antenna. direction : indicates the directional antenna. |
| Defaults | Omnidirectional antenna |
| Command Mode | dot11radio interface configuration mode |

- Usage Guide**
- 1: If omnidirectional or directional antennas need to be configured for all radios, perform configuration in interface range dot11radio configuration mode.
 - 2: This command is applicable only to radios that support both omnidirectional and directional antennas.
 - 3: If the internal antenna and external antenna can be switched, validate the configuration of internal and external antennas prior to that of omnidirectional and directional antennas.

↘ Configuring the Allowable Longest Distance Between an AP and a Wireless Transmission Peer

- Optional.
- If there are no special requirements, you can perform this configuration in the dot11radio interface configuration mode of the AP equipment.
- Adjust the timeout duration according to the distance between the RF interface of the AP and the wireless transmission peer; otherwise, wireless data transmission cannot be performed. However, the timeout duration cannot be excessively long; otherwise, the excessive timeout duration may cause air interface resource waste when the AP does not receive ACK or CTS frames.

| | |
|------------------------------|---|
| Command | peer-distance <i>val</i> |
| Parameter Description | <i>val</i> : indicates the longest distance allowed by an AP, ranging from 1000 to 25000 m. |
| Defaults | 1000m |
| Command Mode | dot11radio interface configuration mode |
| Usage Guide | This configuration is not supported for all APs. This configuration needs to be performed only when the longest distance between an AP and the wireless transmission peer is greater than 1000m. The configured distance may be longer, but cannot be shorter than the actual distance. |

↘ Enabling Mcell

- Optional.
- Enable or disable the Mcell function on the master Dot11Radio interface on an AP unless otherwise specified.
- After the Mcell function is enabled, the receiving sensitivity decreases.

| | |
|------------------------------|--|
| Command | mcell enable no mcell enable |
| Parameter Description | no : Disables the Mcell function. |
| Defaults | Mcell is disabled by default. |
| Command Mode | Master Dot11Radio interface configuration mode |
| Usage Guide | N/A |

↘ Configuring MU-MIMO of a Radio

- Optional.
- If there are no special requirements, you can perform this configuration in the dot11radio interface configuration mode of the AP.
- After configuration, the AP can send data simultaneously to multiple 802.11ac or 802.11ax STAs via MU-MIMO.

| | |
|------------------------------|---|
| Command | mu-mimo enable no mu-mimo enable |
| Parameter Description | no: disables MU-MIMO. |
| Defaults | MU-MIMO is enabled by default. |
| Command Mode | dot11radio interface configuration mode |
| Usage Guide | - |

↘ **Configuring OFDMA of a Radio**

- Optional.
- If there are no special requirements, you can perform this configuration in the dot11radio interface configuration mode of the AP.
- After configuration, 802.11ax STAs can perform data transmission via OFDMA.

| | |
|------------------------------|---|
| Command | ofdma enable no ofdma enable |
| Parameter Description | no: disables OFDMA. |
| Defaults | OFDMA is enabled by default. |
| Command Mode | dot11radio interface configuration mode |
| Usage Guide | - |

Verification

- Run the **show running-config** command to check the configurations of RF parameters.

Configuration Example

↘ **Configuring RF Parameters**

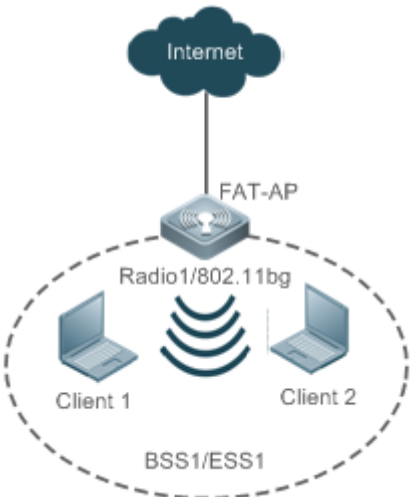
| | |
|--|--|
| <p>Scenario Figure 1-6</p> |  <p>The diagram illustrates a network topology. At the top, a cloud labeled 'Internet' is connected to a device labeled 'FAT-AP'. Below the FAT-AP, a dashed oval represents a Basic Service Set (BSS1/ESS1). Inside this oval, there is a radio interface labeled 'Radio1/802.11bg'. Two laptops, labeled 'Client 1' and 'Client 2', are shown connected to the radio interface.</p> |
| <p>Configuration Steps</p> | <ul style="list-style-type: none"> ● Configure a dot11radio interface on the AP equipment. |
| <p>FAT AP</p> | <pre>Ruijie#config Ruijie(config)#interface Dot11radio 1/0 Ruijie(config-if-Dot11radio 1/0)#beacon dtim-period 3 Ruijie(config-if-Dot11radio 1/0)#apsd enable Ruijie(config-if-Dot11radio 1/0)#ampdu enable Ruijie(config-if-Dot11radio 1/0)#rate-set 11a mandatory 24 Ruijie(config-if-Dot11radio 1/0)#rate-set 11a support 54 Ruijie(config-if-Dot11radio 1/0)#rate-set 11b disable 1 Ruijie(config-if-Dot11radio 1/0)#rate-set 11b disable 2 Ruijie(config-if-Dot11radio 1/0)#rate-set 11g disable 1 Ruijie(config-if-Dot11radio 1/0)#rate-set 11g disable 2 Ruijie(config-if-Dot11radio 1/0)#rate-set 11n mcs-mandatory 3 Ruijie(config-if-Dot11radio 1/0)#rate-set 11n mcs-support 15 Ruijie(config-if-Dot11radio 1/0)#mcast-rate 24 Ruijie(config-if-Dot11radio 1/0)#power local 50 Ruijie(config-if-Dot11radio 1/0)#sta-limit 12 Ruijie(config-if-Dot11radio 1/0)#11asupport enable Ruijie(config-if-Dot11radio 1/0)#11bsupport enable Ruijie(config-if-Dot11radio 1/0)#11gsupport enable</pre> |

```

Ruijie(config-if-Dot11radio 1/0)#llnsupport enable
Ruijie(config-if-Dot11radio 1/0)#llacsupport enable
Ruijie(config-if-Dot11radio 1/0)#response-rssi 20
Ruijie(config-if-Dot11radio 1/0)#assoc-rssi 15
Ruijie(config-if-Dot11radio 1/0)#coverage-area-control 12
Ruijie(config-if-Dot11radio 1/0)#sta-idle-timeout 900
Ruijie(config-if-Dot11radio 1/0)#radio-type 802.11b
Ruijie(config-if-Dot11radio 1/0)#channel 11
Ruijie(config-if-Dot11radio 1/0)#fragment-threshold 1500
Ruijie(config-if-Dot11radio 1/0)#rts threshold 1000
Ruijie(config-if-Dot11radio 1/0)#beacon period 300
Ruijie(config-if-Dot11radio 1/0)#short-preamble
Ruijie(config-if-Dot11radio 1/0)#slottime long
Ruijie(config-if-Dot11radio 1/0)#chan-width 40
Ruijie(config-if-Dot11radio 1/0)#short-gi enable chan-width 20
Ruijie(config-if-Dot11radio 1/0)#short-gi enable chan-width 40
Ruijie(config-if-Dot11radio 1/0)#antenna receive 3
Ruijie(config-if-Dot11radio 1/0)#antenna transmit 3
Ruijie(config-if-Dot11radio 1/0)#external-antenna enable
Ruijie(config-if-Dot11radio 1/0)#antenna type direction
Ruijie(config-if-Dot11radio 1/0)#retries long 4
Ruijie(config-if-Dot11radio 1/0)#retries short 7
Ruijie(config-if-Dot11radio 1/0)#peer-distance 3000
Ruijie(config)# country-code CN

```

Verification

After the user configures RF parameters, verify the dot11radio interface based on displayed dot11radio interface configurations.

- Run the **show running-config** command to check the configurations of the dot11radio interface.

```

Ruijie#show running-config
!
interface Dot11radio 1/0
ip proxy-arp

```

```
rate-set 11b mandatory 5 11
rate-set 11b disable 1 2
rate-set 11g mandatory 5 11
rate-set 11g support 6 9 12 18 24 36 48 54
rate-set 11g disable 1 2
rate-set 11a mandatory 6 12 24
rate-set 11a support 9 18 36 48 54
rate-set 11n mcs-support 15
rate-set 11n mcs-mandatory 3
station-role root-ap
beacon period 300
beacon dtim-period 3
slottime long
rts threshold 1000
sta-limit 12
sta-idle-timeout 900
chan-width 40
radio-type 802.11b
antenna receive 3
antenna transmit 3
external-antenna enable
antenna type direction
coverage-area-control 12
response-rssi 20
assoc-rssi 15
power local 50
channel 11
mcast-rate 24
coverage-rssi 10
peer-distance 3000
!
country-code CN
```

Common Errors

N/A

1.4.4 Configuring E-bag Parameters

Configuration Effect

- Configure the e-bag parameters of an AP and associated RF interfaces to facilitate configuration and management by an administrator.

Notes

- N/A

Configuration Steps

⤵ Configuring the Number of AMPDU Software Re-transmission Times

- Optional.
- If there are no special requirement, you can perform this configuration in the dot11radio interface configuration mode of the AP equipment.
- The larger the number of re-transmission times, the lower the probability of sub-frame loss. However, excessive re-transmission times may cause increase of air interface load and decrease of real-time performance of other packets in the air. In order to avoid packet loss when the probability of sub-frame loss is high, increase the value.

| | |
|------------------------------|---|
| Command | <code>ampdu-retries times</code> |
| Parameter Description | <i>times</i> : indicates the number of software re-transmission times, ranging from 1 to 100. |
| Defaults | The default value is 4. |
| Command Mode | dot11radio interface configuration mode |
| Usage Guide | The configuration is effective only when the RF interfaces of an AP operate at the 11n mode. |

⤵ Configuring Whether to Enable the RTS Protection for AMPDU Aggregation Packets

- (Optional) The RTS protection for AMPDU aggregation packets is disabled by default.
- If there are no special requirements, you can perform this configuration in the dot11radio interface configuration mode of the AP equipment.
- The RTS protection for AMDPU needs to be enabled only when the waste of air interface resources caused by hidden nodes is greater than that caused by RTS interaction.

| | |
|------------------------------|---|
| Command | <code>ampdu-rts</code> |
| Parameter Description | - |
| Defaults | TRRS protection is disabled by default. |

| | |
|---------------------|--|
| Command Mode | dot11radio interface configuration mode |
| Usage Guide | The configuration is effective only when the RF interfaces of an AP operate at the 11n mode. |

✚ Configuring the Number of Ethernet Packets That Can Be Received by an AP at a Time.

- (Optional) The default value varies with APs.
- If there are no special requirements, you can perform this configuration in the global configuration mode of the AP equipment.
- Increasing the number of Ethernet packets that can be received by an AP at a time can increase the performance of the entire network, but may decrease the real-time performance of key packets processed by the AP. For example, in a scenario similar to e-bag where the requirement for performance is not high but concurrency of multiple STAs and high real-time performance of packets are required, the number of Ethernet packets that can be received by an AP at a time can be reduced. A recommended value for this scenario is 25.

| | |
|------------------------------|--|
| Command | eth-schd limit |
| Parameter Description | <i>limit</i> : indicates the number of Ethernet packets that can be received at a time, ranging from 1 to 256. |
| Command Mode | Global configuration mode |
| Usage Guide | - |

✚ Configuring Whether to Support LDPC

- (Optional) LDPC is supported by default.
- If there are no special requirements, you can perform this configuration in the dot11radio interface configuration mode of the AP equipment.
- Supporting LDPC helps increase the reliability and gain of coding. When being used in frequencies with seriously noisy interference, this technology can significantly reduce the risk of information losses. However, a few terminals are not compatible with LDPC, which causes packet losses.

| | |
|------------------------------|---|
| Command | ldpc |
| Parameter Description | - |
| Defaults | LDPC is enabled by default. |
| Command Mode | dot11radio interface configuration mode |
| Usage Guide | - |

✚ Configuring Whether to Enable STBC

- (Optional) STBC is enabled by default.
- If there are no special requirements, you can perform this configuration in the dot11radio interface configuration mode of the AP equipment.

- Enabling STBC helps increase the reliability of data transmission. However, some terminals may not be compatible with this coding mode.

| | |
|------------------------------|---|
| Command | stbc |
| Parameter Description | - |
| Defaults | STBC is enabled by default. |
| Command Mode | dot11radio interface configuration mode |
| Usage Guide | - |

📌 Configuring E-bag Network Optimization by Using the One-Key Mode

- (Optional) There is no default configuration.
- If there are no special requirements, you can perform this configuration in the global configuration mode of the AP equipment.
- The items optimized for AP320/AP330/AP3220 and other products are as follows:
 - (1) Optimization of packet processing at a wired interface: eth-schd 25.
 - (2) Optimization of wireless aggregation packet re-transmission: ampdu-retries 2.
 - (3) wifox is disabled.
- The items optimized for AP530 are as follows:
 - (1) sta-idle-time 1800 is used for Radio 1 and 2 by default.
 - (2) radio 1 optimization: 11b/11g disables the mandatory rates 1, 2, and 5 Mbit/s, and 11g disables the mandatory rates 11 and 24 Mbit/s. ampdu-rts is enabled.

| | |
|------------------------------|---|
| Command | ebag |
| Parameter Description | |
| Command Mode | Global configuration mode |
| Usage Guide | This configuration is often used in an e-bag scenario and should be used with caution in other scenarios. |

Verification

- Run the **show running-config** command to check the e-bag parameter settings.

Configuration Example

📌 Configuring E-bag Parameters

Scenario
Figure 1-7

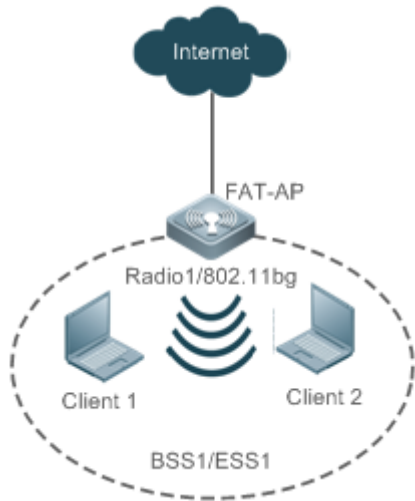

Assuming that in a FAT AP environment, the requirements for configuring e-bag parameters on the AP equipment are as follows:

1. Set the number of AMPDU software re-transmission times to 3 on Radio 1.
2. Enable the RTS protection for AMPDU aggregation packets on Radio 1.
3. Set the number of Ethernet packets received on the AP at a time to 100.
4. Disable LDPC on Radio 1.
5. Disable STBC on Radio 1.

Configuration Steps

- Configure e-bag parameters on the AP as follows:

FAT AP

```
Ruijie# configure terminal
Ruijie(config)# eth-schd 100
Ruijie(config)# interface dot11radio 1/0
Ruijie(config-if-Dot11radio 1/0)# ampdu-retries 3
Ruijie(config-if-Dot11radio 1/0)# ampdu-rts
Ruijie(config-if-Dot11radio 1/0)# no ldpc
Ruijie(config-if-Dot11radio 1/0)# no stbc
```

Verification

- Run the **show running-config** command to check the e-bag parameter settings on the AP.

```
Ruijie(config)# show running-config
!
eth-schd 100
!
```

```
interface Dot11radio 1/0
ampdu-retries 3
ampdu-rts
no stbc
no ldpc
!
```

➤ **Configuring E-bag Network Optimization by Using the One-Key Mode**

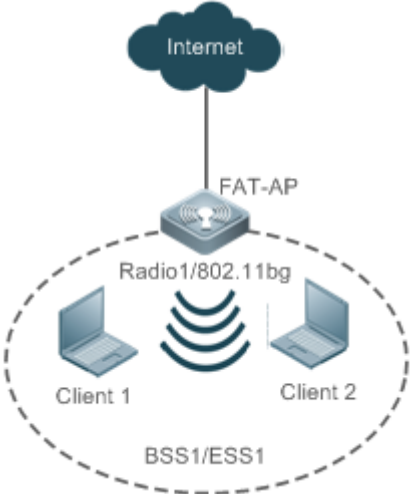
| | |
|---------------------------------------|---|
| <p>Scenario Figure 1-8</p> |  <p>Assuming that in a FATAP environment, an AP operating in the e-bag scenario is required to be configured with e-bag network optimization by using the one-key mode.</p> |
| <p>Configuration Steps</p> | <ul style="list-style-type: none"> ● configure e-bag parameters on an AP: |
| <p>FAT AP</p> | <pre>Ruijie# configure terminal Ruijie(config)# ebag</pre> |
| <p>Verification</p> | <ul style="list-style-type: none"> ● Run the show running-config command to check the e-bag parameter settings on a specified AP. |
| | <pre>Ruijie(config)# show running-config ! eth-schd 25 ! interface Dot11radio 1/0</pre> |

```

ampdu-retries 2

no ampdu-rts

!

interface Dot11radio 2/0

ampdu-retries 2

no ampdu-rts

!

```

Common Errors

- N/A.

1.4.5 Configuring the Link Integrity Check Function

Configuration Effect

- Enable the link integrity check function.

Notes

- N/A

Configuration Steps

↳ Enabling the Link Integrity Check Function

- (Mandatory) Run the **link-check enable** command to enable the link integrity check function.

| | |
|------------------------------|---|
| Command | link-check enable |
| Parameter Description | - |
| Command Mode | Global configuration mode |
| Usage Guide | The link integrity check function is disabled by default. |

Verification

- Run the **show running-config** command to check the link integrity check function.

Configuration Example

↳ Configuring the Link Integrity Check Function

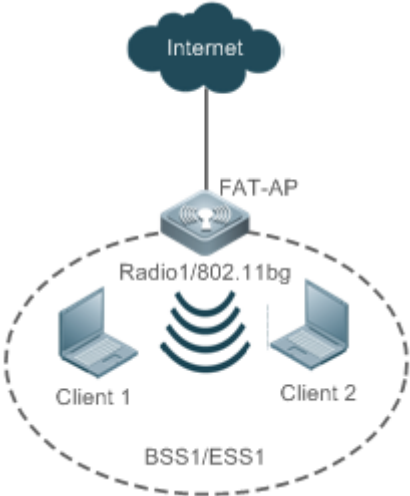
| | |
|---------------------------------------|--|
| <p>Scenario Figure 1-9</p> |  <p>If the link integrity check function needs to be enabled in a FAT AP environment as shown in Figure 1-9, then:</p> <ol style="list-style-type: none"> 1. Enable the link integrity check function. |
| <p>Configuration Steps</p> | <ul style="list-style-type: none"> ● Configure the link integrity check function on the AP equipment. |
| <p>FAT AP</p> | <pre>Ruijie# configure terminal Ruijie(config)# link-check enable</pre> |
| <p>Verification</p> | <ul style="list-style-type: none"> ● Run the show running-config command to check the configuration. |
| | <pre>Ruijie(config)# show running-config link-check enable</pre> |

Common Errors

- N/A

1.4.6 Configuring a WLAN by Using the One-Key Mode

Configuration Effect

- On empty devices, this function can be used to rapidly configure WLANs, which helps geological prospecting personnel to achieve rapid configuration and improve the operation efficiency and helps channels to rapidly configure WLANs for performance testing.

Notes

- N/A.

Configuration Steps

↘ Configuring a WLAN by Using the One-Key Mode

- Optional.
- Run the **autowifi** command to perform one-key WLAN configuration in the config mode to achieve rapid configuration of a WLAN. This function helps geological prospecting personnel to achieve rapid configuration and improve the operation efficiency, and helps channels to rapidly configure WLANs for performance testing.

| | |
|---------------------|---|
| Command | autowifi |
| Parameter | - |
| Description | |
| Defaults | - |
| Command Mode | Global configuration mode of an AP |
| Usage Guide | <p>The one-key WLAN configuration function is provided to implement rapid configuration for an empty device.</p> <p>This function helps geological prospecting personnel to achieve rapid configuration and improve the operation efficiency,</p> <p>and helps channels to rapidly configure WLANs for performance testing.</p> |

Verification

- Run the **show running-config** command to check the one-key WLAN configuration.

Configuration Example

↘ Configuring a WLAN by Using the One-Key Mode

Scenario
Figure 1-10

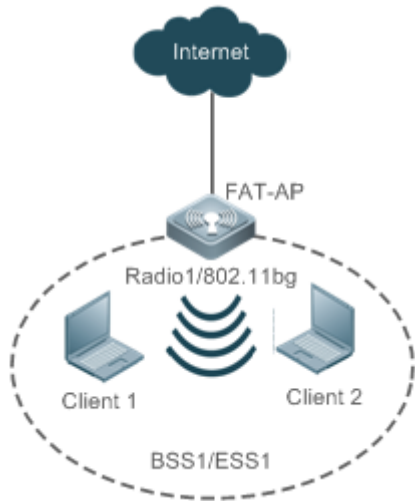

If one-key WLAN configuration needs to be performed on the AP equipment in a FAT AP environment, then:

Configuration Steps

- commands to perform one-key WLAN configuration on the AP equipment:

FAT AP

```
Ruijie# configure terminal
Ruijie(config)# autowifi
```

Verification

- Run the **show running-config** command to check the one-key WLAN configuration.

```
Ruijie#show running-config

fair-schedule
!
spectral
!
cwmp
!
service dhcp
!
ip dhcp pool web_sta_pool_1
 network 192.168.110.0 255.255.255.0
 dns-server 8.8.8.8
 default-router 192.168.110.1
```

```
!  
no service password-encryption  
!  
dot11 wlan 1  
!  
link-check disable  
!  
nfpp  
!  
wids  
!  
wlocation  
!  
vlan 1  
!  
vlan 10  
!  
interface GigabitEthernet 0/1  
  encapsulation dot1Q 1  
!  
interface Dot11radio 1/0  
  encapsulation dot1Q 10  
  chan-width 20  
  country-code CN  
  radio-type 802.11b  
  channel 1  
  antenna receive 3  
  antenna transmit 3  
  rate-set 11b mandatory 1 2 5 11  
  rate-set 11g mandatory 1 2 5 11  
  rate-set 11g support 6 9 12 18 24 36 48 54  
  rate-set 11n mcs-support 15
```



```
no ampdu-rts

wlan-id 1

station-role root-ap

!

interface Dot11radio 2/0

encapsulation dot1Q 10

chan-width 20

country-code CN

no short-preamble

radio-type 802.11a

channel 149

antenna receive 3

antenna transmit 3

rate-set 11a mandatory 6 12 24

rate-set 11a support 9 18 36 48 54

rate-set 11n mcs-support 15

no ampdu-rts

wlan-id 1

station-role root-ap

!

interface BVI 1

ip address 192.168.110.1 255.255.255.0

!

wlansec 1

security rsn enable

security rsn ciphers aes enable

security rsn akm psk enable

security rsn akm psk set-key ascii autowifi

!

no offline-detect

!

line console 0
```

```

login

password admin

line vty 0 4

  privilege level 15

  login

  password admin

!

end

```

1.4.7 Configuring the Maximum Number of STAs on a Fat AP

Configuration Effect

- Configure the maximum number of STAs on a fat AP.

Notes

- The maximum number of STAs can be configured only on fat APs.

Configuration Steps

📌 Configuring the Maximum Number of STAs on a Fat AP

- Optional.

| | |
|------------------------------|---|
| Command | sta-limit num |
| Parameter Description | <i>num</i> : Indicates the maximum number of STAs that can access an AP. |
| Defaults | The maximum number of STAs that can access an AP is not limited. |
| Command Mode | Global configuration mode |
| Usage Guide | Note that the maximum number of STAs on an AP is independent from the maximum number of STAs on each RF interface. The maximum number of STAs on an AP is not the sum of maximum number of STAs on all RF interfaces of the AP. When the maximum number of STAs on an AP or an RF interface reaches the limit, new STAs will be rejected. |

Verification

- Run the **show running-config** command to display the configurations.

Configuration Example

📌 Configuring the Maximum Number of STAs on a Fat AP

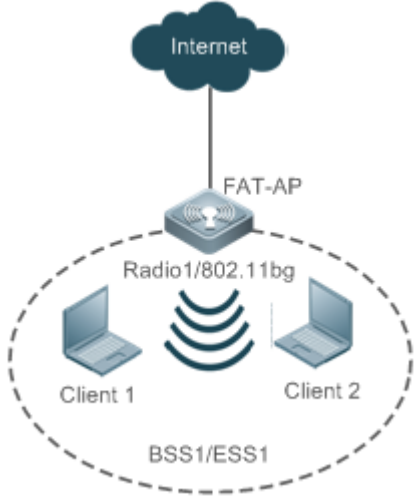
| | |
|--|---|
| <p>Scenario Figure 1-11</p> |  |
| <p>Configuration Steps</p> | <ul style="list-style-type: none"> ● Set the maximum number of STAs on a fat AP to 128. |
| <p>FAT-AP</p> | <pre>Ruijie#config Ruijie(config)#sta-limit 128</pre> |
| <p>Verification</p> | <ul style="list-style-type: none"> ● Run the show running-config command to display the maximum number of STAs on a fat AP. |
| | <pre>Ruijie#show running-config ! sta-limit 128 !</pre> |

Common Errors

After the maximum number of STAs on a fat AP is increased, the maximum number of STAs on an RF interface is modified while the maximum number of STAs on the fat AP is not modified. As a result, the expected number of STAs cannot be reached.

1.4.8 Cancelling Power Supply Limits

Configuration Effect

- When the negotiated power supply limit is 15.4 W, configure the **poe-unlimit** command to cancel power supply limits.

Notes

- After this command is configured, if the power consumption of an AP is greater than the output power of the power supply device, the AP automatically restarts.

Configuration Steps

✚ Cancelling Power Supply Limits

- Optional.
- Cancel power supply limits on a radio interface in a specified band in configuration mode.
- Cancel power supply limits on a specified radio interface in dot11 radio primary interface configuration mode.

| | |
|------------------------------|--|
| Command | poe-unlimit [radio-type { 802.11b 802.11a }] |
| Parameter Description | radio-type: required in the command in global configuration mode but not in dot11 radio primary interface configuration mode. 802.11b: Indicates that a radio interface works in the 2 GHz band. 802.11a: Indicates that a radio interface works in the 5 GHz band. |
| Defaults | The power supply is not limited by default. |
| Command Mode | Global configuration mode or dot11 radio primary interface configuration mode |
| Usage Guide | After this command is configured, if the output power of the power supply device is smaller than the required power consumption of an AP, the AP will restart. |

Verification

- Run the **show running-config** command to display the configurations.

Configuration Example

✚ Cancelling Power Supply Limits

| | |
|--------------------------------|---|
| Scenario Figure 1-12 | |
| Configuration Steps | <ul style="list-style-type: none"> • Cancel the power supply policy on the device. |
| FAT-AP | Ruijie#config |

| | |
|---------------------|--|
| | <pre>Ruijie(config)# interface dot11radio 2/0 Ruijie(config-if-Dot11radio 2/0)#poe-unlimit</pre> |
| Verification | <ul style="list-style-type: none"> Run the show running-config command to display the user quantity limit on the device. |
| | <pre>Ruijie#show running-config ! ! interface Dot11radio 2/0 poe-unlimit !</pre> |

1.4.9 Enabling/Disabling an AP to Supply Power to External Devices via the Ethernet Cable

Configuration Effect

- Enable or disable an AP to supply power to external devices via the Ethernet cable.

Notes

- Only some models of fat APs support this function.

Configuration Steps

▾ Enabling/Disabling an AP to Supply Power to External Devices via the Ethernet Cable

- Optional.
- Run this command to enable/disable an AP to supply power to external devices via the Ethernet cable in global configuration mode.

| | |
|------------------------------|--|
| Command | poeout { enable disable default } |
| Parameter Description | enable: Enables an AP to supply power to external devices via the Ethernet cable. disable: Disables an AP to supply power to external devices via the Ethernet cable. default: Use the default settings for an AP to supply power to external devices via the Ethernet cable. |
| Defaults | The default settings are used for an AP to supply power to external devices via the Ethernet cable. |
| Command Mode | Global configuration mode |
| Usage Guide | This command is automatically saved after being configured, without a need to use the write command for saving. This command does not support the no poeout and default poeout forms. |

Verification

- Run the **show poeout** command to display the configurations.

Configuration Example

➤ Enabling an AP to Supply Power to External Devices via the Ethernet Cable

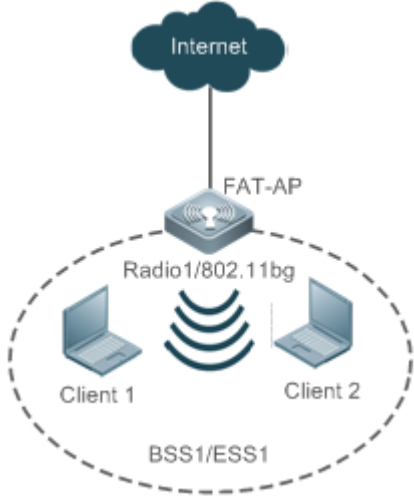
| | |
|--|--|
| <p>Scenario Figure 1-13</p> |  |
| | |
| <p>Configuration Steps</p> | <ul style="list-style-type: none"> Enable an AP to supply power to external devices via the Ethernet cable. |
| <p>FAT-AP</p> | <pre>Ruijie#config Ruijie(config)#poeout enable</pre> |
| | |
| <p>Verification</p> | <ul style="list-style-type: none"> Run the show poeout command to display the configured command. |
| | <pre>Ruijie#show poeout poeout enable Ruijie#</pre> |

1.5 Monitoring

Displaying

| Description | Command |
|--|--|
| Displays the configurations of a FATAP. | show running-config |
| Displays the radio information and configurations of a WNIC. | show dot11 wireless <i>interface-num</i> |
| Displays the connection information of a WNIC. | show dot11 associations <i>H.H.H interface-name</i> |
| Displays information about all users connected to a WNIC. | show dot11 associations all-client |
| Displays a created BSS list. | show dot11 mbssid |

| | |
|---|---|
| Displays the online status and capability information of all RF interfaces. | show dot11 radio-status |
| Displays the rate sets of all RF interfaces. | show dot11 rate-set |
| Displays radio information and configurations of a WLAN. | show dot11 wlan <i>wlan-id</i> |
| Displays a working channel supported by a WNIC. | show dot11 channels active <i>interface-name</i> |
| Displays all working channels supported by a WNIC. | show dot11 channels all <i>interface-name</i> |
| Displays e-bag radio information and configurations. | show ebag |



Access Service Configuration

1. Configuring Interfaces
 2. Configuring MAC Address
 3. Configuring VLAN
 4. Configuring VLAN Group
 5. Configuring RLDP
 6. Configuring LLDP
 7. Configuring PPPoE-client
-

1 Configuring Interfaces

1.1 Overview

Interfaces are important parts for data exchange on network devices. Ruijie Networks devices support two types of interfaces: physical interfaces and logical interfaces. A physical interface is a real entity that exists on a device, for example, FastEthernet (FE) or GigabitEthernet (GE) interface. A logical interface is a virtual interface that does not actually exist on a router. A logical interface can be associated with or independent of a physical interface, for example, a loopback or tunnel interface. In network protocols, physical and logical interfaces are treated equally.

1.2 Applications

| Application | Description |
|--|---|
| Route-based Communication Through Ethernet Physical Interfaces | Layer-3 data communication is implemented on network devices through Ethernet interfaces. |

1.2.1 Route-based Communication Through Ethernet Physical Interfaces

Scenario

Figure 1-1

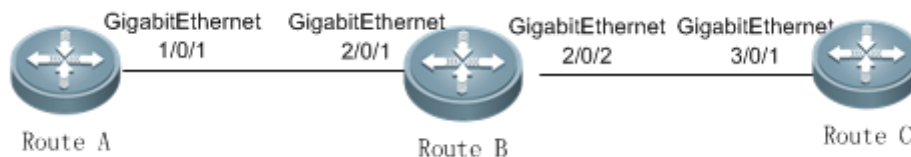

As shown in the above figure, Router A, Router B, and Router C form a simple route-based data communication network.

Deployment

- Connect Router A to Router B through physical interfaces GigabitEthernet 1/0/1 and GigabitEthernet 2/0/1.
- Connect Router B to Router C through physical interfaces GigabitEthernet 2/0/2 and GigabitEthernet 3/0/1.
- Set the IP addresses of GigabitEthernet 1/0/1 and GigabitEthernet 2/0/1 respectively to 192.168.1.1/24 and 192.168.1.2/24 which are in the same network segment.
- Set the IP addresses of GigabitEthernet 2/0/2 and GigabitEthernet 3/0/1 respectively to 192.168.2.1/24 and 192.168.2.2/24 which are in the same network segment.
- Configure a static route on Router C so that Router C can directly go through the 192.168.1.0/24 network segment. Configure a static route on Switch A so that Switch A can directly go through the 192.168.2.0/24 network segment on layer 3.

- Run ping 192.168.2.2 and ping 192.168.1.1 respectively on Router A and Router C to achieve route-based communication on Router B.

1.3 Features

Basic Concepts

▾ Interface Types

Interfaces on Ruijie Networks devices are classified into two categories:

- Local Area Network (LAN) interface
 - Logical interface
1. Common LAN interfaces fall into the following types:
 - Ethernet interface (FE and GE)
 2. Common logical interfaces fall into the following types:
 - Sub interface
 - Loopback interface
 - Null interface
 - Tunnel interface

▾ Ethernet Interface

An Ethernet interface is a single physical interface on a device mainly used for LAN communication. Ethernet interfaces include 10M Ethernet interfaces and 10M/100M FE interfaces, which comply with 10Base-T and 100Base-TX standards respectively. 10Base-T Ethernet interfaces work at 10 Mbps in full-duplex or half-duplex mode. Compatible with 10Base-T interfaces, 100Base-TX interfaces can work at 10 Mbps and 100 Mbps in full-duplex or half-duplex mode at the same time. 100Base-TX interfaces feature auto-negotiation which identifies Ethernet interfaces on other devices automatically.

▾ Sub Interface

A sub interface is a logical interface derived from a physical interface. One physical interface may be configured with multiple sub interfaces. In this way, high flexibility is provided for applications. Sub interfaces are multiple logical interfaces derived from a physical interface. In other words, the multiple logical interfaces are associated with the physical interface, and they share the configurations of the physical interface while having their own configurations at link layer and network layer.

▾ Loopback Interface

A loopback interface is a local logical Layer-3 interface that is completely emulated by software and is always linked. Packets sent to a loopback interface are processed on the device locally, including routing information. The IP address of a loopback interface can be used as the router ID (RID) for the OSPF routing protocol, the network interface ID replied to Telnet access requests, or the network interface ID for remote Telnet access. The procedure of configuring a loopback interface is similar to that of configuring an Ethernet interface. You can regard a loopback interface as a virtual Ethernet interface.

Null Interface

A null interface is a virtual interface. Such a virtual interface is only equivalent to an available system device. A null interface is always linked and never proactively sends or receives network data. Any packets sent to a null interface will be discarded. Any encapsulation attempt by link-layer protocols on a null interface will fail. No command can be configured on a null interface (excluding the **help** and **exit** commands available for each interface).

A null interface is more often used to filter network traffic. If a null interface is configured, the undesired data will be routed to the null interface without using the Access Control List (ACL).

Tunnel Interface

A tunnel interface implements the tunnel function by using transmission protocols (such as IP) to transmit packets under any protocol. Same as other logical interfaces, a tunnel interface is also a virtual system interface. Instead of particularly specifying any transmission protocol or load protocol, a tunnel interface provides a standard point-to-point transmission mode. Since that, a tunnel interface must be set for each individual link.

Overview

| Feature | Description |
|--|--|
| Configuring Interfaces | You can configure interface attributes in interface configuration mode. If the interface to be configured is a logical interface which does not exist, create the interface after the interface configuration mode is entered. |
| Configuring the Interface Description and Status | You can name an interface for identification of the interface features. You can set the status of an interface. |
| Configuring the MTU | You can set the Maximum Transmission Unit (MTU) for an interface to control the maximum size of the frames received or sent on this interface. |
| Enabling or Disabling Link Trap | You can enable or disable link trap on an interface. |
| Enabling Interface Index Persistence | If interface index persistence is enabled, the interface index remains the same after the device is restarted. |
| Configuring the Bandwidth | You can configure the interface bandwidth in interface configuration mode. |
| Configuring the Load Calculation Interval | You can specify the time interval of calculating the loads of packet input/output. |
| Configuring the Carrier Delay | You can modify the acceptable carrier delay of an interface within which the link status switching from Down to Up or from Up to Down. |
| Configuring the 802.1Q VLAN Tag | You can specify the VLAN encapsulation tag on an Ethernet interface or sub interface. When sending packets, the interface encapsulates the specified VLAN tag into a packet to communicate with another device in the VLAN. |
| Configuring the Rate and Duplex Mode | You can adjust the rate and duplex mode of an interface. |
| Enabling Module Auto-Detection | If interface rate auto-negotiation is enabled, the interface rate can be automatically adjusted based on the type of the inserted module. |

1.3.1 Configuring Interfaces

Run the **interface** command in global configuration mode to enter the interface configuration mode. In interface configuration mode, you can configure interface attributes.

Working Principle

Run the **interface** command in global configuration mode to enter the interface configuration mode. If the interface to be configured is a logical interface which does not exist, the interface will be created after the interface configuration mode is enabled. You can also run the **interface range** or **interface range macro** command in global configuration mode to create and configure interfaces (interface IDs) within a specific range. The interfaces within one range must be of the same type and have the same features.

You can run the **no interface** or **no interface range** command in global configuration mode to delete a logical interface or logical interfaces within a specific range.

↘ Interface Numbering Rules

In standalone mode, the interface ID of a physical interface consists of two parts: slot number and interface number in the slot. For example, if the slot number is 2 and the interface number in the slot is 3, the interface ID is 2/3. In VSU mode or stacking mode, the interface ID of a physical interface consists of three parts: device number, slot number, and interface number in the slot. For example, if the device number is 1, the slot number is 2, and the interface number in the slot is 3, the interface ID is 1/2/3.

The device number ranges from 1 to the maximum number of supported member devices.

Slot numbering rule: The number of a fixed slot is 0 while that of a dynamic slot (swappable module or line card) ranges from 1 to the number of slots. For dynamic slots, face the device panel to sequence the slots from front to back, left to right, and up to down, with the slot number increasing from 1.

The interface number in the slot ranges from 1 to the number of interfaces in the slot, increasing one by one from left to right.

↘ Configuring Interfaces Within a Specific Range

You can run the **interface range** command in global configuration mode to configure multiple interfaces at the same time. The attributes you set under this command apply to all interfaces within the range you have selected.

Specify interfaces within a certain range.

The **interface range** command can be used to specify multiple interface ranges.

The **macro** parameter can be specified using the macro of a range. For details, see "Configuring the Interface Macro".

Ranges can be separated by commas (,).

The types of interfaces of all ranges specified in one command must be the same.

Pay attention to the format of the **range** parameter when you run the **interface range** command.

The following common interface range formats are valid:

- **FastEthernet** device/slot/{first interface} - {last interface}

- GigabitEthernet device/slot/{first interface} - {last interface}
- Loopback loopback-ID - loopback-ID, ranging from 1 to the maximum number of loopback interfaces supported by the device
- Tunnel tunnel-ID - tunnel-ID, ranging from 1 to the maximum number of tunnel interfaces supported by the device

Interfaces within one interface range must be of the same type. That is, all of them are FastEthernet, GigabitEthernet or loopback interfaces.

▾ [Configuring the Interface Macro](#)

You can define some macros to avoid manually entering interface ranges. Before using the **macro** keyword in the **interface range** command, you need to run the **define interface-range** command to define these macros in global configuration mode.

Run the **no define interface-range** *macro_name* command in global configuration mode to delete the configured macros.

[Related Configuration](#)

▾ [Configuring an Interface](#)

You can run the **interface** command to enter the interface configuration mode.

▾ [Configuring Interfaces Within a Specific Range](#)

You can run the **interface range** command in global configuration mode to configure multiple interfaces at the same time. These interfaces must be of the same type, such as FastEthernet or GigabitEthernet.

▾ [Configuring the Interface Macro](#)

To avoid manually entering interface ranges, you can define some macros that are easy to remember and distinguish. Before using the **macro** keyword in the **interface range** command, you need to run the **define interface-range** command to define these macros in global configuration mode. No macro is configured by default.

▾ [Configuring a Loopback Interface](#)

No loopback interface is created by default.

You can run the **interface loopback** *loopback-interface-number* command in global configuration mode to create a loopback interface. The value of *loopback-interface-number* ranges from 1 to the maximum number of loopback interfaces supported by a device. After a loopback interface is successfully created, enter the interface configuration mode of this loopback interface. You can run the **no interface loopback** *loopback-interface-number* command to delete a specified loopback interface.

▾ [Configuring a Tunnel Interface](#)

No tunnel interface is created by default.

You can run the **interface tunnel** *tunnel-number* command in global configuration mode to create a tunnel interface. The value of *tunnel-number* ranges from 1 to the maximum number of tunnel interfaces supported by a device. After a tunnel

interface is successfully created, enter the interface configuration mode of this tunnel interface. You can run the **no interface tunnel** *tunnel-number* command to delete a specified tunnel interface.

1.3.2 Configuring the Interface Description and Status

You can name an interface for identification of the interface features.

You can enable or disable an interface in interface configuration mode.

Working Principle

↘ Interface Description

You can name an interface based on the purpose it is used for. For example, if you want to assign GigabitEthernet 0/1 to user A, you can describe this interface as "Port for User A".

↘ Interface Status

An interface has two states: Up and Down. If an interface is disabled, it is in Down state; otherwise, it is in Up state. In certain cases, you may need to disable an interface. You can directly disable an interface by setting the status of the interface. If an interface is disabled, the interface will not receive or send any frames, indicating that all its features are lost. You can also re-enable a disabled interface by setting the status of the interface.

Related Configuration

↘ Configuring the Interface Description

An interface is not described by default.

You can describe an interface based on its features. To describe an interface, run the **description** *string* command in interface configuration mode.

↘ Configuring the Interface Status

An interface is in Up state by default.

You can set the status of an interface based on your needs. Run the **shutdown** command in interface configuration mode to disable an interface, and the interface status changes to Down. You can run the **no shutdown** command to re-enable a disabled interface.

1.3.3 Configuring the MTU

You can set the MTU for an interface to control the maximum size of the frames received or sent on this interface.

Working Principle

When exchanging a great throughput of data, an interface may receive jumbo frames whose size is larger than that of typical Ethernet frames. MTU is the size of a valid data segment of a frame. It does not include the overhead of Ethernet encapsulation.

If the size of a frame received or forwarded by an interface exceeds the specified MTU, the frame will be discarded.

 The **mtu** command is valid only for physical interfaces.

Related Configuration

↘ [Configuring the MTU](#)

The default MTU of an interface is generally 1,500 bytes.

Run the **mtu num** command in interface configuration mode to set the MTU for an interface.

1.3.4 Enabling or Disabling Link Trap

In interface configuration mode, you can configure whether to send link traps of an interface on a device.

Working Principle

If link trap is enabled on an interface, the SNMP sends link traps when the link status of the interface changes.

Related Configuration

↘ [Enabling Link Trap](#)

Link trap is enabled by default.

In interface configuration mode, you can run the [**no**] **snmp trap link-status** command to enable or disable link trap on an interface.

1.3.5 Enabling Interface Index Persistence

Similar to interface description, an interface index is also used to identify an interface. It is the ID of an interface. Every time an interface is created, the system automatically assigns a unique index to the interface. When the device is restarted, the index of the interface may change. If interface index persistence is enabled, the interface index remains the same after the device is restarted.

Working Principle

If interface index persistence is enabled, the index of an interface remains the same after the device is restarted.

Related Configuration

↘ [Enabling Interface Index Persistence](#)

Interface index persistence is disabled by default.

You can run the **snmp-server if-index persist** command in global configuration mode to enable interface index persistence.

1.3.6 Configuring the Bandwidth

Working Principle

The **bandwidth** command is used for some routing protocols (for example, OSPF) to calculate the route metrics and for Resource Reservation Protocol (RSVP) to calculate the retained bandwidth. Modifying the interface bandwidth will not affect the data transmission rate of a physical interface.

-  Running this command does not affect the fixed bandwidth of an interface at the physical layer, which functions as a routing factor.

Related Configuration

Configuring the Bandwidth

By default, the interface bandwidth depends on the interface type. For example, the default interface bandwidth of a GE interface is 1,000,000 and that of a 10GE interface is 10,000,000.

You can run the **bandwidth** *kilobits* command in interface configuration mode to set the interface bandwidth. *kilobits* indicates the bandwidth per second, in the unit of Kbps. It ranges from 1 to the maximum Ethernet rate supported by Ruijie devices. For 40GE physical interfaces with the maximum rate capability, the maximum bandwidth is 40,000,000. You can run the **no bandwidth** command to restore the default value.

1.3.7 Configuring the Load Calculation Interval

Working Principle

The **load-interval** command can be used to set the interval of calculating packet input/output. Usually the interval is set to 10 seconds.

Related Configuration

Configuring the Load Calculation Interval

The default value of **load-interval** is 10 seconds.

You can run the **load-interval** *seconds* command in interface configuration mode to set **load-interval** of an interface. The value of *seconds* ranges from 5 to 600 seconds, which must be an integer multiple of 5. You can run the **no load-interval** command to restore the default value.

1.3.8 Configuring the Carrier Delay

Working Principle

The carrier delay refers to the acceptable time delay in status change of the Data Carrier Detect (DCD) signal from Down to Up or from Up to Down. If the DCD status changes within the delay, the system will ignore this change and the upper data link layer does not need to renegotiate. If the carrier delay is set to a large value, nearly every transient DCD change will be ignored. On the contrary, if the parameter is set to **0**, every DCD signal change however minor will be detected by the system, resulting in higher instability.

-
- i** If the DCD carrier interrupts for a long time, set the parameter to a smaller value to accelerate topology convergence and route summarization. On the contrary, if the period of DCD carrier interruption is smaller than the time of topology convergence or route summarization, set the parameter to a larger value to avoid topology or route flapping.
-

Related Configuration

↳ Configuring the Carrier Delay

The default value of **carry-delay** for an interface is 2 seconds.

Run the **carrier-delay** *seconds* command in interface configuration mode to set **carrier-delay** for an interface. The value of *seconds* ranges from 0 to 60 seconds. You can run the **no carrier-delay** command to restore the default value.

1.3.9 Configuring the 802.1Q VLAN Tag

Working Principle

A virtual LAN (VLAN), namely a logical network partitioned in a physical network, is a layer-2 network of the OSI model. IEEE issued the 802.1Q protocol standard in 1999 to standardize VLAN implementation.

The VLAN technology allows a network administrator to partition a physical LAN into different broadcast areas (or VLANs) logically. Each VLAN consists of a group of computer workstations with the same needs. Therefore, they have the same features as the physical LAN. However, since VLANs are partitioned logically but not physically, the workstations in a VLAN do not need to be placed in the same physical space. In other words, these workstations do not necessarily belong to the same physical LAN network segment. The broadcast and unicast traffic on a VLAN cannot be forwarded to other VLANs, which helps control traffic, reduces equipment investment, simplifies network management, and improves network security.

VLAN is a protocol proposed to solve the Ethernet broadcast problem and security issues. On the basis of an Ethernet frame, a VLAN header is added and a VLAN ID is used to assign users into smaller work groups to restrict the mutual access at Layer 2 between different work groups. Each work group is a VLAN. The advantage of a VLAN is to restrict the broadcasting scope, build virtual work groups, and dynamically manage networks.

To communicate with a host in a VLAN, you can configure the 802.1Q (VLAN protocol) VLAN encapsulation tag on an Ethernet interface or sub interface. In this way, the Ethernet interface encapsulates the VLAN header when sending a packet and detaches the VLAN header when receiving a packet.

Related Configuration

↳ Configuring the 802.1Q VLAN Tag

By default, the 802.1Q encapsulation protocol is disabled for interfaces.

You can run the **encapsulation dot1Q** *VlanID* command in interface configuration mode to encapsulate 802.1Q on an interface. *VlanID* is the VLAN ID to be encapsulated.

1.3.10 Configuring the Rate and Duplex Mode

You can configure the rate and duplex mode of an Ethernet interface and AP.

Working Principle

↘ Interface Rate

Generally, a device automatically negotiates the rate of an Ethernet interface with the peer device. The negotiated rate can be any rate within the maximum rate supported. You can also specify any rate within the interface capability to enable the Ethernet interface to work at this specified rate.

When you set the rate of an AP, the rate is actually valid for all its member interfaces (all of which are Ethernet interfaces).

↘ Interface Duplex

Ethernet interfaces and APs support three duplex modes:

- If an interface is configured to work in full-duplex mode, the interface can send and receive packets at the same time.
- If an interface is configured to work in half-duplex mode, the interface can only send or receive packets at a time.
- If an interface is configured to work in auto-negotiation mode, the interface automatically negotiates its duplex status with the peer interface.

When you configure the duplex mode of an AP, the mode is actually valid for all its member interfaces (all of which are Ethernet interfaces).

Related Configuration

↘ Configuring the Rate

Rate auto-negotiation is enabled on an interface by default. That is, the interface rate is set in auto-configuration mode by default.

You can run the **speed { 10 | 100 | 1000 | auto }** command in interface configuration mode to set the interface rate, which must be within the maximum rate of the interface. Or you can also enable auto-negotiation mode on the interface.

↘ Configuring the Duplex Mode

Duplex auto-negotiation is enabled on an interface by default. That is, the interface duplex mode is configured to **auto** by default.

You can run the **duplex { full | half | auto }** command in interface configuration mode to configure the interface duplex mode.

1.3.11 Enabling Module Auto-Detection

If an interface works in auto-negotiation mode, the interface rate can be automatically adjusted based on the detected type of the inserted module.

Working Principle

Currently, two types of modules are supported: SFP (Gigabit) and SFP+ (10 Gigabit). If an SFP module is inserted, the interface works in Gigabit mode. If an SFP+ module is inserted, the interface works in 10 Gigabit mode.



 Module auto-detection takes effect only when the interface works in auto-negotiation mode.

Related Configuration

↳ Enabling the Auto-Negotiation Mode

By default, the auto-negotiation mode and module auto-detection are enabled concurrently. When the interface rate is set to a sum of any values, module auto-detection will be disabled.

1.4 Configuration

| Configuration | Description and Command | |
|--|---|--|
| Configuring Interfaces |  (Optional) It is used to create, delete, and describe an interface. | |
| | interface | Creates an interface (including a sub interface) and enters the interface configuration mode of this interface, or directly enters the interface configuration mode of an interface. |
| | interface range | Configures interfaces within a specific range. If no interface is created, this command can be used to create and configure interfaces in batches. |
| | define interface-range | Defines the interface macro for batch operation. |
| | snmp-server if-index persist | Enables interface index persistence. That is, an interface index remains the same after the device is restarted. |
| | description | Describes an interface in interface configuration mode with a maximum of 32 characters. |
| | snmp trap link-status | Enables link trap on an interface in interface configuration mode. |
| | shutdown | Disables an interface in interface configuration mode. |
| Configuring Interface Attributes |  (Optional) It is used to configure interface attributes. | |
| | bandwidth | Configures the interface bandwidth in interface configuration mode. |
| | carrier-delay | Configures the carrier delay of an interface in interface configuration mode. |
| | load-interval | Configures the load calculation interval of an interface in interface configuration mode. |
| | duplex | Configures the duplex mode of an interface. |
| | mtu | Configures the MTU of an interface. |
| | speed | Configures the interface rate. |
| encapsulation dot1Q | Configures the 802.1Q VLAN tag on an interface. | |

1.4.1 Configuring Interfaces

Configuration Effect

- Create a specified logical interface and enter the interface configuration mode. For an existing physical or logical interface, directly enter the interface configuration mode.
- Create specified logical interfaces in batches and enter the interface configuration mode. For an existing physical or logical interface, directly enter the interface configuration mode.
- Enable interface index persistence so that the interface index remains the same after the device is restarted.
- Configure the interface description to intuitively and vividly describe an interface.
- Enable or disable link trap on an interface.
- Configure the interface status by enabling or disabling the interface.

Notes

- N/A

Configuration Steps

▾ Configuring an Interface

- (Optional) Run the interface command in global configuration mode.
- This command is used to create a non-existing logical interface or configure an existing physical or logical interface in interface configuration mode.
- You can run the **no** form of this command to delete a logical interface, which does not apply to physical interfaces.
- You can run the **default** form of this command to restore the default settings of a specified physical or logical interface in interface configuration mode.

▾ Configuring Interfaces Within a Specific Range

- (Optional) To configure this function, run the **interface range** command.
- Run this command in global configuration mode.
- To create non-existing logical interfaces in batches or configure multiple existing physical or logical interfaces in interface configuration mode, run this command.
- You can run the **no** form of this command to delete logical interfaces within a specified range. This command does not apply to physical interfaces.
- You can run the **default** form of this command to restore the default settings of interfaces within a specified range in interface configuration mode.

▾ Enabling Interface Index Persistence

- (Optional) To configure this function, run the **snmp-server if-index persist** command.
 - Run this command in global configuration mode.
-

- You can run the `no` or default form of this command to disable this function.

↘ **Configuring the Interface Description**

- (Optional) To configure the interface description, run the `description` command.
- Run this command in interface configuration mode.
- You can run the `no` or default form of this command to delete the configured interface description.

↘ **Enabling or Disabling Link Trap**

- (Optional) To configure this function, run the `snmp trap link-status` command.
- Run this command in interface configuration mode.
- You can run the `no` or default form of this command to disable this function.

↘ **Configuring the Interface Status**

- (Optional) To disable an interface, run the `shutdown` command.
- Run this command in interface configuration mode.
- You can run the `no` or default form of this command to re-enable the interface.

Verification

↘ **Configuring an Interface**

- If you can enter the interface configuration mode after running the `interface` command, the configuration is successful.
- After running the `no interface` command on a logical interface, you can also run the `show running` command to check whether the interface still exists. If not, the interface has been properly deleted.
- After running the `default interface` command on an interface, you can run the `show running` command to check whether the configurations under the interface are restored to the default values. If so, the configuration is successful.

↘ **Configuring Interfaces Within a Specific Range**

- If you can properly enter the interface configuration mode after running the `interface range` command, the configuration is successful.
- After running the `no interface range` command on a logical interface, you can also run the `show running` command to check whether the interface exists. If not, the interface has been properly deleted.
- After running the `default interface` command for an interface, you can run the `show running` command to check whether the configurations under the interface are restored to the default values. If so, the configuration is successful.

↘ **Enabling Interface Index Persistence**

- After running the `snmp-server if-index persist` command, run `write` to save the configuration. Then restart the device and run the `show interface` command to display the interface index. If the interface index remains the same after the device is restarted, the configuration is successful.
-

➤ **Enabling or Disabling Link Trap**

- Select a physical interface, plug or remove the network cable, and then start the SNMP server. If the SNMP server can properly receive the traps about link status changes of an interface, the function is enabled properly.
- After running the no form of this command, select a physical interface, plug or remove the network cable, and then start the SNMP server. If the SNMP server cannot receive the traps about link status changes of this interface, link trap has been properly disabled.

➤ **Configuring the Interface Status**

- Select a physical interface, install the network cable to make the interface Up, and run the shutdown command to disable this interface. If the Syslog information on the Console shows that the interface status changes to Down and the LED of this interface turns off, the interface is properly disabled. Then run the no shutdown command to restart this interface. If the Syslog information on the Console shows that the interface status changes to Up and the LED of this interface turns on, the interface is properly re-enabled.

Related Commands

➤ **Configuring an Interface**

| | |
|------------------------------|---|
| Command | interface <i>interface-type interface-number</i> |
| Parameter Description | <i>interface-type interface-number</i> : Indicates the interface type and ID. The following interface types are supported: Ethernet interface and loopback interface. |
| Command Mode | Global configuration mode |
| Usage Guide | <ul style="list-style-type: none"> ● If a logical interface is not created, the interface is created after the interface configuration mode is entered. ● If an interface is a physical interface or an existing logical interface, directly enter the interface configuration mode. ● Run the no form of this command to delete a specified logical interface. ● Run the default form of this command to restore the default configurations in interface configuration mode. |

➤ **Configuring Interfaces Within a Specific Range**

| | |
|------------------------------|--|
| Command | interface range { <i>port-range</i> macro <i>macro_name</i> } |
| Parameter Description | <p><i>port-range</i>: Indicates the type and ID range of interfaces to be operated in batches. The following interface types are supported: Ethernet interface and loopback interface.</p> <p><i>macro_name</i>: Indicates the macro name for interfaces within a specific range.</p> |
| Command Mode | Global configuration mode |
| Usage Guide | <ul style="list-style-type: none"> ● If logical interfaces to be configured do not exist, create them and then enter the interface configuration mode. ● If interfaces to be configured are physical interfaces or existing logical interfaces, directly enter the |

| | |
|--|---|
| | <p>interface configuration mode.</p> <ul style="list-style-type: none"> ● Run the no form of this command to delete specified logical interfaces in batches. ● Run the default form of this command to restore the default configurations in batches in interface configuration mode. ● To use a macro, run the define interface-range command in global configuration mode to set <i>macro_name</i> for interfaces within a specific range, and then run the interface range macro macro_name command to configure these interfaces in batches. |
|--|---|

↘ Enabling Interface Index Persistence

| | |
|------------------------------|---|
| Command | snmp-server if-index persist |
| Parameter Description | N/A |
| Command Mode | Global configuration mode |
| Usage Guide | After you run this command and save the configuration, all interface indexes will be saved. After the device is restarted, an interface index assigned before the restart will be used. |

↘ Enabling Link Trap

| | |
|------------------------------|---|
| Command | snmp trap link-status |
| Parameter Description | N/A |
| Command Mode | Interface configuration mode |
| Usage Guide | This command is used to configure whether to send link traps of an interface. If yes, the SNMP server sends traps when the link status of an interface changes. If no, the SNMP server does not send traps unless the link status of the interface changes. |

↘ Configuring the Interface Description

| | |
|------------------------------|--|
| Command | description <i>string</i> |
| Parameter Description | <i>string</i> . Indicates the interface description. |
| Command Mode | Interface configuration mode |
| Usage Guide | Run this command to enter the interface configuration mode and then modify the interface configurations. |

↘ Configuring the Interface Status

| | |
|------------------------------|------------------------------|
| Command | shutdown |
| Parameter Description | N/A |
| Command Mode | Interface configuration mode |

| | |
|--------------------|---|
| Usage Guide | Run the shutdown command to disable an interface. Run the no shutdown command to re-enable an interface. In certain cases, the no shutdown command cannot be executed. For example, if an interface is in violation state, the no shutdown command cannot be executed on the interface. |
|--------------------|---|

Configuration Example

Configuring Interfaces

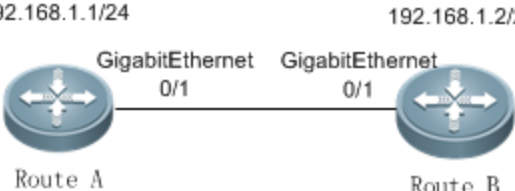
| | |
|--------------------------------------|--|
| Scenario Figure 1-2 |  |
| Configuration Steps | <ul style="list-style-type: none"> ● Connect two routers through Ethernet interfaces. ● Configure both routers with IP addresses in the same network segment. ● Enable interface index persistence on both routers. ● Enable link trap on both routers. ● Configure the interface status on both routers. |
| A | <pre>A# configure terminal A(config)# snmp-server if-index persist A(config)# interface gigabitethernet 0/1 A(config-if-GigabitEthernet 0/1)# ip address 192.168.1.1 255.255.255.0 A(config-if-GigabitEthernet 0/1)# snmp trap link-status A(config-if-GigabitEthernet 0/1)# shutdown A(config-if-GigabitEthernet 0/1)# end A# write</pre> |
| B | <pre>B# configure terminal B(config)# snmp-server if-index persist B(config)# interface gigabitethernet 0/1 B(config-if-GigabitEthernet 0/1)# ip address 192.168.1.2 255.255.255.0 B(config-if-GigabitEthernet 0/1)# snmp trap link-status B(config-if-GigabitEthernet 0/1)# shutdown B(config-if-GigabitEthernet 0/1)# end B# write</pre> |

| | |
|----------------------------|---|
| <p>Verification</p> | <p>Perform the following operations on Router A and Router B respectively:</p> <ul style="list-style-type: none"> ● After running the shutdown command, check whether the interface status of GigabitEthernet 0/1 is correct. ● After running the shutdown command, check whether GigabitEthernet 0/1 sends traps when the link status of this interface changes to Down. ● After the device is restarted, check whether the interface index of GigabitEthernet 0/1 remains the same. |
| <p>A</p> | <pre>A# show interfaces gigabitEthernet 0/1 Index(dec):1 (hex):1 GigabitEthernet 0/1 is administratively down , line protocol is DOWN Hardware is PQ3 TSEC GIGABIT ETHERNET CONTROLLER GigabitEthernet, address is 0a0b.0c0d.0e0e (bia 0a0b.0c0d.0e0e) Interface address is: 192.168.1.1/24 ARP type: ARPA, ARP Timeout: 3600 seconds Interface IPv6 address is: No IPv6 address MTU 1500 bytes, BW 1000000 Kbit Encapsulation protocol is Ethernet-II, loopback not set Keepalive interval is 10 sec , set Carrier delay is 2 sec Rxload is 1/255, Txload is 1/255 Ethernet attributes: Medium-type is Copper Last link state change time: 2013-12-20 13:55:20 Time duration since last link state change: 5 days, 5 hours, 17 minutes, 36 seconds Priority is 0 admin duplex mode is AUTO, oper duplex is Unknown admin speed is AUTO, oper speed is Unknown Rxload is 1/255, Txload is 1/255 10 seconds input rate 0 bits/sec, 0 packets/sec 10 seconds output rate 0 bits/sec, 0 packets/sec 4 packets input, 408 bytes, 0 no buffer, 0 dropped</pre> |

| | |
|----------|--|
| | <pre> Received 0 broadcasts, 0 runts, 0 giants 0 input errors, 0 CRC, 0 frame, 0 overrun, 0 abort 4 packets output, 408 bytes, 0 underruns , 0 dropped 0 output errors, 0 collisions, 0 interface resets </pre> |
| B | <pre> B# show interfaces gigabitEthernet 0/1 Index(dec):1 (hex):1 GigabitEthernet 0/1 is administratively down , line protocol is DOWN Hardware is PQ3 TSEC GIGABIT ETHERNET CONTROLLER GigabitEthernet, address is 00d0.f8fb.5945 (bia 00d0.f8fb.5945) Interface address is: 192.168.1.2/24 ARP type: ARPA, ARP Timeout: 3600 seconds Interface IPv6 address is: No IPv6 address MTU 1500 bytes, BW 1000000 Kbit Encapsulation protocol is Ethernet-II, loopback not set Keepalive interval is 10 sec , set Carrier delay is 2 sec Rxload is 1/255, Txload is 1/255 Ethernet attributes: Medium-type is Copper Last link state change time: 2013-12-20 13:55:20 Time duration since last link state change: 5 days, 5 hours, 17 minutes, 36 seconds Priority is 0 admin duplex mode is AUTO, oper duplex is Unknown admin speed is AUTO, oper speed is Unknown Rxload is 1/255, Txload is 1/255 10 seconds input rate 0 bits/sec, 0 packets/sec 10 seconds output rate 0 bits/sec, 0 packets/sec 4 packets input, 408 bytes, 0 no buffer, 0 dropped Received 0 broadcasts, 0 runts, 0 giants 0 input errors, 0 CRC, 0 frame, 0 overrun, 0 abort 4 packets output, 408 bytes, 0 underruns , 0 dropped </pre> |

| |
|---|
| 0 output errors, 0 collisions, 0 interface resets |
|---|

Common Errors

- N/A

1.4.2 Configuring Interface Attributes

Configuration Effect

- Connect devices through routing interfaces for data communication.
- Adjust interface attributes on devices.

Notes

- N/A

Configuration Steps

▾ Configuring the Interface Rate

- (Optional) If this function is required, run the **speed** command in interface configuration mode.
- The default interface rate negotiation is **auto**.

▾ Configuring the Duplex Mode

- (Optional) If this function is required, run the **duplex** command in interface configuration mode.
- The default duplex mode is **auto**.

▾ Configuring the MTU

- (Optional) If this function is required, run the **mtu** command in interface configuration mode.
- Generally, the default MTU of an interface is 1,500 bytes.

▾ Configuring the Bandwidth

- (Optional) If this function is required, run the **bandwidth** command in interface configuration mode.
- Generally, the interface bandwidth is the same as the interface rate.

▾ Configuring the Carrier Delay

- (Optional) If this function is required, run the **carrier-delay** command in interface configuration mode.
- The default carrier delay is 2 seconds.

▾ Configuring the Load Calculation Interval

- (Optional) If this function is required, run the **load-interval** command in interface configuration mode.
 - The default load interval is 10 seconds.
-

↘ Configuring the 802.1Q VLAN Tag

- (Optional) If this function is required, run the **encapsulation dot1Q** command in interface configuration mode.
- The 802.1Q encapsulation protocol is disabled by default.

Verification

- Run the **show interfaces** command to display the status of interface attributes.

Related Commands

↘ Configuring the MTU

| | |
|------------------------------|--|
| Command | mtu num |
| Parameter Description | <i>num</i> : The minimum value is 64. The maximum value varies with the product and depends on the chip. |
| Command Mode | Interface configuration mode |
| Usage Guide | Set the MTU of an interface to the maximum length of the link layer data. At present, you can only set the MTU of physical interfaces and APs. |

↘ Configuring the Interface Rate

| | |
|------------------------------|--|
| Command | speed [10 100 1000 auto] |
| Parameter Description | 10 : Sets the interface rate to 10 Mbps. 100 : Sets the interface rate to 100 Mbps. 1000 : Sets the interface rate to 1000 Mbps. auto : Sets the interface rate to auto-sensing. |
| Command Mode | Interface configuration mode |
| Usage Guide | The rate of an AP member interface depends on the rate of the AP. If a member interface exits the AP, set its rate independently. Run the show interfaces command to display the configuration. You need to set different rates for different interface types. For example, the rate of an SFP port cannot be set to 10 Mbps. |

↘ Configuring the Duplex Mode

| | |
|------------------------------|--|
| Command | duplex { auto full half } |
| Parameter Description | auto : Indicates auto switch between full-duplex mode and half-duplex mode. full : Indicates full-duplex mode. half : Indicates half-duplex mode. |
| Command Mode | Interface configuration mode |
| Usage Guide | The duplex attribute of an interface depends on the interface type. You can run the show interfaces command to display the duplex configuration of an interface. |

↘ Configuring the Carrier Delay

| | |
|------------------------------|--|
| Command | carrier-delay <i>seconds</i> |
| Parameter Description | <i>seconds</i> : Indicates the carrier delay ranging from 0 to 60 seconds. |
| Command Mode | Interface configuration mode |
| Usage Guide | N/A |

▾ **Configuring the Load Calculation Interval**

| | |
|------------------------------|---|
| Command | load-interval <i>seconds</i> |
| Parameter Description | <i>seconds</i> : Indicates the load calculation Interval ranging from 5 to 600 seconds. |
| Command Mode | Interface configuration mode |
| Usage Guide | N/A |

▾ **Configuring the Bandwidth**

| | |
|------------------------------|---|
| Command | bandwidth <i>kilobits</i> |
| Parameter Description | <i>kilobits</i> : Indicates the interface bandwidth, ranging from 1 to the maximum Ethernet rate supported by Ruijie devices in the unit of Kbps. |
| Command Mode | Interface configuration mode |
| Usage Guide | N/A |

▾ **Configuring the 802.1Q VLAN Tag**

| | |
|------------------------------|---|
| Command | encapsulation dot1Q <i>VlanID</i> |
| Parameter Description | <i>VlanID</i> : Indicates VLAN ID ranging from 1 to 4094. |
| Command Mode | Interface configuration mode |
| Usage Guide | N/A |

Configuration Example

▾ **Configuring Interface Attributes**

| | |
|-------------------------------|--|
| Scenario Figure 1-3 |  |
| Configuration | <ul style="list-style-type: none"> On Switch A, configure GigabitEthernet 0/1 as a trunk interface, configure SVI 2, and configure the IP |

| | |
|-----------------|---|
| Steps | <p>address and the route to Switch B for SVI 2.</p> <ul style="list-style-type: none"> ● On Router A, enable VLAN ID encapsulation for GigabitEthernet 0/1.1, set VLAN ID to 2, and configure the IP address; enable FR encapsulation for Serial 1/0, configure an IP address in another network segment, and configure the RIP routing protocol to create a route to Switch B. ● On Router B, enable VLAN ID encapsulation for GigabitEthernet 0/1.1, set VLAN ID to 2, and configure the IP address; enable FR encapsulation for Serial 1/0, configure an IP address in another network segment, and configure the RIP routing protocol to create a route to Switch A. ● On Switch B, configure GigabitEthernet 0/1 as a trunk interface, configure SVI 2, and configure the IP address and the route to Switch A for SVI 2. |
| Switch A | <pre>SA# configure terminal SA(config)# interface GigabitEthernet 0/1 SA(config-if)# switchport mode trunk SA(config-if)# exit SA(config)# interface vlan 2 SA(config-if)# ip address 192.168.1.2 255.255.255.0 SA(config-if)# exit SA(config)# ip route 0.0.0.0 255.255.255.0 VLAN 1 192.168.1.1</pre> |
| Router A | <pre>RA# configure terminal RA(config)# interface GigabitEthernet 0/1.1 RA(config-if)# encapsulation dot1Q 2 RA(config-if)# ip address 192.168.1.1 255.255.255.0 RA(config-if)# exit RA(config)# interface Serial 1/0 RA(config-if)# encapsulation frame-relay RA(config-if)# ip address 172.16.1.1 255.255.255.0 RA(config-if)# exit RA(config)# router rip RA(config-router)# network 192.168.1.0 RA(config-router)# network 17.16.1.0 RA(config-router)# exit</pre> |
| Router B | <pre>RB# configure terminal RB(config)# interface GigabitEthernet 0/1.1 RB(config-if)# encapsulation dot1Q 2</pre> |

| | |
|---------------------|---|
| | <pre>RB(config-if)# ip address 192.168.2.1 255.255.255.0 RB(config-if)# exit RB(config)# interface Serial 1/0 RB(config-if)# encapsulation frame-relay RB(config-if)# ip address 172.16.1.2 255.255.255.0 RB(config-if)# exit RB(config)# router rip RB(config-router)# network 192.168.2.0 RB(config-router)# network 17.16.1.0 RB(config-router)# exit</pre> |
| Switch B | <pre>SB# configure terminal SB(config)# interface GigabitEthernet 0/1 SB(config-if)# switchport mode trunk SB(config-if)# exit SB(config)# interface vlan 2 SB(config-if)# ip address 192.168.2.2 255.255.255.0 SB(config-if)# exit SB(config)# ip route 0.0.0.0 255.255.255.0 VLAN 1 192.168.2.1</pre> |
| Verification | <p>Perform the following operations on Switch A, Switch B, Router A, and Router B respectively :</p> <ul style="list-style-type: none"> ● Enable Switch A to ping the IP addresses of the other three devices and ensure that the four devices can have access to each other. ● Check whether Router A and Router B can successfully ping each other. ● Check whether the interface status is correct. |
| Switch A | <pre>SA# show interfaces gigabitEthernet 0/1 Index(dec):1 (hex):1 GigabitEthernet 0/1 is UP , line protocol is UP Hardware is GigabitEthernet Interface address is: no ip address MTU 1500 bytes, BW 100000 Kbit Encapsulation protocol is Bridge, loopback not set Keepalive interval is 10 sec , set</pre> |

Carrier delay is 2 sec

Rxload is 1/255, Txload is 1/255

| Queue | Transmitted packets | Transmitted bytes | Dropped packets | Dropped bytes |
|-------|---------------------|-------------------|-----------------|---------------|
| 0 | 0 | 0 | 0 | 0 |
| 1 | 0 | 0 | 0 | 0 |
| 2 | 0 | 0 | 0 | 0 |
| 3 | 0 | 0 | 0 | 0 |
| 4 | 0 | 0 | 0 | 0 |
| 5 | 0 | 0 | 0 | 0 |
| 6 | 0 | 0 | 0 | 0 |
| 7 | 363 | 85164 | 0 | 0 |

Switchport attributes:

interface's description:""

admin medium-type is Copper, oper medium-type is Copper

lastchange time:0 Day: 0 Hour: 1 Minute: 9 Second

Priority is 0

admin duplex mode is AUTO, oper duplex is Full

admin speed is AUTO, oper speed is 100M

flow control admin status is OFF, flow control oper status is OFF

admin negotiation mode is OFF, oper negotiation state is ON

Storm Control: Broadcast is OFF, Multicast is OFF, Unicast is OFF

Port-type: trunk

Native vlan: 1

Allowed vlan lists: 1-4094

Active vlan lists: 1-5

10 seconds input rate 0 bits/sec, 0 packets/sec

10 seconds output rate 67 bits/sec, 0 packets/sec

362 packets input, 87760 bytes, 0 no buffer, 0 dropped

Received 0 broadcasts, 0 runts, 0 giants

0 input errors, 0 CRC, 0 frame, 0 overrun, 0 abort

363 packets output, 82260 bytes, 0 underruns , 0 dropped

0 output errors, 0 collisions, 0 interface resets

| | |
|-----------------|---|
| Router A | <pre>RA# show interfaces gigabitEthernet 0/1.1 Index(dec):10 (hex):10 GigabitEthernet 0/1 is UP , line protocol is UP Hardware is OCTEON-SGMII GigabitEthernet, address is 00d0.f8fb.5945 (bia 00d0.f8fb.5945) Interface address is: 192.168.1.1/24 ARP type: ARPA, ARP Timeout: 3600 seconds Interface IPv6 address is: No IPv6 address MTU 1500 bytes, BW 1000000 Kbit Encapsulation protocol is 802.1Q Virtual LAN, Vlan ID 2 RA# show interface serial 1/0 Index(dec):1 (hex):1 Serial 1/0 is UP , line protocol is UP Hardware is Infineon DSCC4 PEB20534 H-10 serial Interface address is: 172.16.1.1/24 Interface IPv6 address is: No IPv6 address MTU 1500 bytes, BW 2000 Kbit Encapsulation protocol is frame-relay, loopback not set Keepalive interval is 10 sec , set Carrier delay is 2 sec Queueing strategy: WFQ Rxload is 1/255, Txload is 1/255 5 minutes input rate 0 bits/sec, 0 packets/sec 5 minutes output rate 0 bits/sec, 0 packets/sec 235 packets input, 434532 bytes, 0 no buffer Received 0 broadcasts, 0 runts, 0 giants 0 input errors, 0 CRC, 0 frame, 0 overrun, 0 abort 35 packets output, 36545 bytes, 0 underruns 0 output errors, 0 collisions, 0 interface resets</pre> |
| Router B | <pre>RB# show interfaces gigabitEthernet 0/1.1</pre> |

| | |
|------------------------|--|
| | <pre> Index(dec):10 (hex):10 GigabitEthernet 0/1 is UP , line protocol is UP Hardware is OCTEON-SGMII GigabitEthernet, address is 00d0.f8fb.5946 (bia 00d0.f8fb.5946) Interface address is: 192.168.2.1/24 ARP type: ARPA, ARP Timeout: 3600 seconds Interface IPv6 address is: No IPv6 address MTU 1500 bytes, BW 1000000 Kbit Encapsulation protocol is 802.1Q Virtual LAN, Vlan ID 2 RB# show interface serial 1/0 Index(dec):1 (hex):1 Serial 1/0 is UP , line protocol is UP Hardware is Infineon DSCC4 PEB20534 H-10 serial Interface address is: 172.16.1.1/24 Interface IPv6 address is: No IPv6 address MTU 1500 bytes, BW 2000 Kbit Encapsulation protocol is frame-relay, loopback not set Keepalive interval is 10 sec , set Carrier delay is 2 sec Queueing strategy: WFQ Rxload is 1/255, Txload is 1/255 5 minutes input rate 0 bits/sec, 0 packets/sec 5 minutes output rate 0 bits/sec, 0 packets/sec 235 packets input, 434532 bytes, 0 no buffer Received 0 broadcasts, 0 runts, 0 giants 0 input errors, 0 CRC, 0 frame, 0 overrun, 0 abort 35 packets output, 36545 bytes, 0 underruns 0 output errors, 0 collisions, 0 interface resets </pre> |
| <p>Switch B</p> | <pre> SB# show interfaces gigabitEthernet 0/1 Index(dec):1 (hex):1 </pre> |

```
GigabitEthernet 0/1 is UP , line protocol is UP
Hardware is GigabitEthernet
Interface address is: no ip address
MTU 1500 bytes, BW 100000 Kbit
Encapsulation protocol is Bridge, loopback not set
Keepalive interval is 10 sec , set
Carrier delay is 2 sec
Rxload is 1/255, Txload is 1/255
Queue    Transmitted packets    Transmitted bytes    Dropped packets    Dropped bytes
  0                0                0                0                0
  1                0                0                0                0
  2                0                0                0                0
  3                0                0                0                0
  4                0                0                0                0
  5                0                0                0                0
  6                0                0                0                0
  7                363             85164            0                0
Switchport attributes:
  interface's description:""
  admin medium-type is Copper, oper medium-type is Copper
  lastchange time:0 Day: 0 Hour: 1 Minute: 9 Second
  Priority is 0
  admin duplex mode is AUTO, oper duplex is Full
  admin speed is AUTO, oper speed is 100M
  flow control admin status is OFF, flow control oper status is OFF
  admin negotiation mode is OFF, oper negotiation state is ON
  Storm Control: Broadcast is OFF, Multicast is OFF, Unicast is OFF
Port-type: trunk
  Native vlan: 1
  Allowed vlan lists: 1-4094
  Active vlan lists: 1-5
10 seconds input rate 0 bits/sec, 0 packets/sec
```

```

10 seconds output rate 67 bits/sec, 0 packets/sec
362 packets input, 87760 bytes, 0 no buffer, 0 dropped
Received 0 broadcasts, 0 runts, 0 giants
0 input errors, 0 CRC, 0 frame, 0 overrun, 0 abort
363 packets output, 82260 bytes, 0 underruns , 0 dropped
0 output errors, 0 collisions, 0 interface resets

```

Common Errors

N/A

1.5 Monitoring

Clearing

 Running the **clear** commands may lose vital information and interrupt services.

| Description | Command |
|--------------------------------|--|
| Clears the interface counters. | clear counters [<i>interface-type interface-number</i>] |
| Restarts an interface. | clear interface <i>interface-type interface-number</i> |

Displaying

↳ Displaying Interface Configuration and Status

| Description | Command |
|--|---|
| Displays the status and configuration of an interface. | show interfaces [<i>interface-type interface-number</i>] |
| Displays the time and times of link status changes. | show interfaces [<i>interface-type interface-number</i>] link-state-change statistics |
| Displays the description and status of an interface. | show interfaces [<i>interface-type interface-number</i>] description |
| Displays the counters of an interface, among which the rate may have an error within 0.5%. | show interfaces [<i>interface-type interface-number</i>] counters |
| Displays the counters of packets increased in the previous sampling interval. | show interfaces [<i>interface-type interface-number</i>] counters increment |
| Displays the error counters on an interface. | show interfaces [<i>interface-type interface-number</i>] counters error |
| Displays the Tx/Rx rate of an interface. | show interfaces [<i>interface-type interface-number</i>] counters rate |

| Description | Command |
|---|---|
| Displays the counter summary of an interface. | show interfaces [<i>interface-type interface-number</i>] counters summary |
| Displays the bandwidth usage of an interface. | show interfaces [<i>interface-type interface-number</i>] usage |

2 Configuring MAC Address

2.1 Overview

A MAC address table contains the MAC addresses, interface numbers and VLAN IDs of the devices connected to the local device.

When a device forwards a packet, it finds an output port from its MAC address table according to the destination MAC address and the VLAN ID of the packet.

After that, the packet is unicast, multicast or broadcast.

i This document covers dynamic MAC addresses, static MAC addresses and filtered MAC addresses. For the management of multicast MAC addresses, please see *Configuring IGMP Snooping Configuration*.

Protocols and Standards

- IEEE 802.3: Carrier sense multiple access with collision detection (CSMA/CD) access method and physical layer specifications
- IEEE 802.1Q: Virtual Bridged Local Area Networks

2.2 Applications

| Application | Description |
|---|--|
| MAC Address Learning | Forward unicast packets through MAC addresses learning. |
| MAC Address Change Notification | Monitor change of the devices connected to a network device through MAC address change notification. |

2.2.1 MAC Address Learning

Scenario

Usually a device maintains a MAC address table by learning MAC addresses dynamically. The operating principle is described as follows:

As shown in the following figure, the MAC address table of the switch is empty. When User A communicates with User B, it sends a packet to the port GigabitEthernet 0/2 of the switch, and the switch learns the MAC address of User A and stores it in the table.

As the table does not contain the MAC address of User B, the switch broadcasts the packet to the ports of all connected devices except User A, including User B and User C.

Figure 2-1 Step 1 of MAC Address Learning

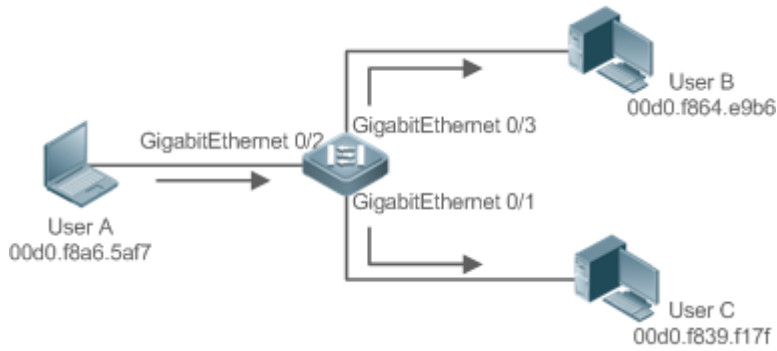

Figure 2-2 MAC Address Table 1

| Status | VLAN | MAC address | Interface |
|---------|------|----------------|---------------------|
| Dynamic | 1 | 00d0.f8a6.5af7 | GigabitEthernet 0/2 |

When User B receives the packet, it sends a reply packet to User A through port GigabitEthernet 0/3 on the switch. As the MAC address of User A is already in the MAC address table, the switch send the reply unicast packet to port GigabitEthernet 0/2 port and learns the MAC address of User B. User C does not receive the reply packet from User B to User A.

Figure 2-3 Step 2 of MAC Address Learning

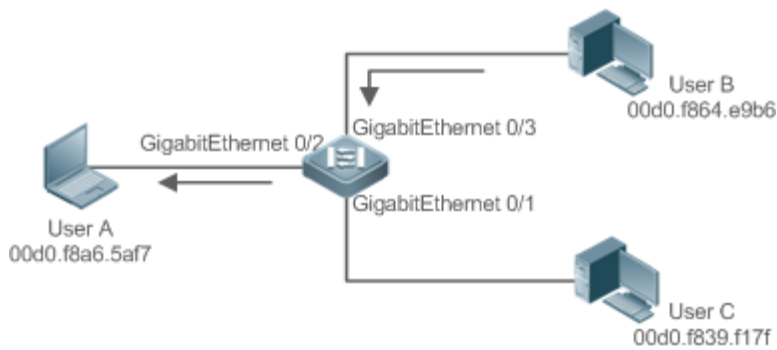

Figure 2-4 MAC Address Table 2

| Status | VLAN | MAC address | Interface |
|---------|------|----------------|---------------------|
| Dynamic | 1 | 00d0.f8a6.5af7 | GigabitEthernet 0/2 |
| Dynamic | 1 | 00d0.f8a4.e9b6 | GigabitEthernet 0/3 |

Through the interaction between User A and User B, the switch learns the MAC addresses of User A and User B. After that, packets between User A and User B will be exchanged via unicast without being received by User C.

Deployment

- With MAC address learning, a layer-2 switch forwards packets through unicast, reducing broadcast packets and network load.

2.2.2 MAC Address Change Notification

MAC address change notification provides a mechanism for the network management system (NMS) to monitor the change of devices connected to a network device.

Scenario

Figure 2-5 MAC Address Change Notification

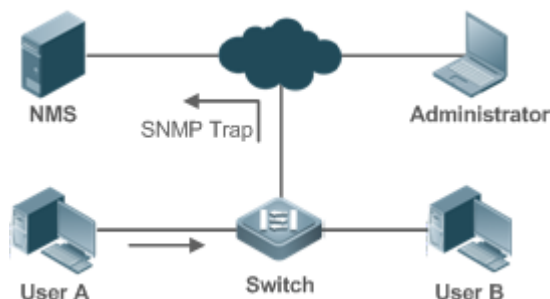

After MAC address change notification is enabled on a device, the device generates a notification message when the device learns a new MAC address or finishes aging a learned MAC address, and sends the message in an SNMP Trap message to a specified NMS.

A notification of adding a MAC address indicates that a new user accesses the network, and that of deleting a MAC address indicates that a user sends no packets within an aging time and usually the user exits the network.

When a network device is connected to a number of devices, a lot of MAC address changes may occur in a short time, resulting in an increase in traffic. To reduce traffic, you may configure an interval for sending MAC address change notifications. When the interval expires, all notifications generated during the interval are encapsulated into a message.

±When a notification is generated, it is stored in the table of historical MAC address change notifications. The administrator may know recent MAC address changes by checking the table of notification history even without NMS.

i A MAC address change notification is generated only for a dynamic MAC address.

Deployment

- Enable MAC address change notification on a layer-2 switch to monitor the change of devices connected to a network device.

2.3 Features

Basic Concepts

Dynamic MAC Address

A dynamic MAC address is a MAC address entry generated through the process of MAC address learning by a device.

Address Aging

A device only learns a limited number of MAC addresses, and inactive entries are deleted through address aging.

A device starts aging a MAC address when it learns it. If the device receives no packet containing the source MAC address, it will delete the MAC address from the MAC address table when the time expires.





➤ Forwarding via Unicast

If a device finds in its MAC address table an entry containing the MAC address and the VLAN ID of a packet and the output port is unique, it will send the packet through the port directly.

➤ Forwarding via Broadcast

If a device receives a packet containing the destination address ffff.ffff.ffff or an unidentified destination address, it will send the packet through all the ports in the VLAN where the packet is from, except the input port.

2.4 Configuration

| Configuration | Description and Command | |
|--|--|---|
| Configuring Dynamic MAC Address |  (Optional) It is used to enable MAC address learning. | |
| | mac-address-table aging-time | Configures an aging time for a dynamic MAC address. |
| Configuring a Static MAC Address |  (Optional) It is used to bind the MAC address of a device with a port of a switch. | |
| | mac-address-table static | Configures a static MAC address. |
| Configuring a MAC Address for Packet Filtering |  (Optional) It is used to filter packets. | |
| | mac-address-table filtering | Configures a MAC address for packet filtering. |
| Configuring MAC Address Change Notification |  (Optional) It is used to monitor change of devices connected to a network device. | |
| | mac-address-table notification | Configures MAC address change notification globally. |
| | snmp trap mac-notification | Configures MAC address change notification on an interface. |

2.4.1 Configuring Dynamic MAC Address

Configuration Effect

Learn MAC addresses dynamically and forward packets via unicast.

Configuration Steps

➤ Configuring an Aging Time for a Dynamic MAC Address

- Optional.
- Configure an aging time for dynamic MAC addresses.
-

| | |
|------------------------------|---|
| Command | mac-address-table aging-time <i>value</i> |
| Parameter Description | <i>value</i> : Indicates the aging time. The value is either 0 or in the range from 10 to 1000,000. |
| Defaults | The default is 300s. |
| Command Mode | Global configuration mode |
| Usage Guide | If the value is set to 0, MAC address aging is disabled and learned MAC addresses will not be aged. |

 The actual aging time may be different from the configured value, but it is not more than two times of the configured value.

Verification

- Check whether a device learns dynamic MAC addresses.
- Run the **show mac-address-table dynamic** command to display dynamic MAC addresses.
- Run the **show mac-address-table aging-time** command to display the aging time for dynamic MAC addresses.

| | |
|------------------------------|--|
| Command | show mac-address-table dynamic [address <i>mac-address</i>] [interface <i>interface-id</i>] [vlan <i>vlan-id</i>] |
| Parameter Description | address <i>mac-address</i> : Displays the information of a specific dynamic MAC address. interface <i>interface-id</i> : Specifies a physical interface or an AP port. vlan <i>vlan-id</i> : Displays the dynamic MAC addresses in a specific VLAN. |
| Command Mode | Privileged EXEC mode/Global configuration mode/Interface configuration mode |
| Usage Guide | N/A |

```
Ruijie# show mac-address-table dynamic
Vlan      MAC Address      Type      Interface
-----
1         0000.0000.0001   DYNAMIC   GigabitEthernet 1/1
1         0001.960c.a740   DYNAMIC   GigabitEthernet 1/1
1         0007.95c7.dff9   DYNAMIC   GigabitEthernet 1/1
1         0007.95cf.eee0   DYNAMIC   GigabitEthernet 1/1
1         0007.95cf.f41f   DYNAMIC   GigabitEthernet 1/1
1         0009.b715.d400   DYNAMIC   GigabitEthernet 1/1
1         0050.bade.63c4   DYNAMIC   GigabitEthernet 1/1
```

| Field | Description |
|-------|-------------|
|-------|-------------|

| | |
|-------------|--|
| Vlan | Indicates the VLAN where the MAC address resides. |
| MAC Address | Indicates a MAC Address. |
| Type | Indicates a MAC address type. |
| Interface | Indicates the interface where the MAC address resides. |

| | |
|------------------------------|--|
| Command | show mac-address-table aging-time |
| Parameter Description | N/A |
| Command Mode | Privileged EXEC mode/Global configuration mode/Interface configuration mode |
| Usage Guide | N/A |
| | <pre>Ruijie# show mac-address-table aging-time</pre> <p>Aging time: 300</p> |

Configuration Example

Configuring Dynamic MAC Address

| | |
|-------------------------------|--|
| Scenario Figure 2-6 |  |
| Configuration Steps | <ul style="list-style-type: none"> Configure the aging time for dynamic MAC addresses to 180s. Delete all dynamic MAC addresses in VLAN 1 on port GigabitEthernet 0/1. |
| | <pre>Ruijie# configure terminal Ruijie(config)# mac aging-time 180 Ruijie# clear mac-address-table dynamic interface GigabitEthernet 0/1 vlan 1</pre> |
| Verification | <ul style="list-style-type: none"> Check MAC address learning on an interface. Display the aging time for dynamic MAC addresses. Display all dynamic MAC addresses in VLAN 1 on port GigabitEthernet 0/1. |
| | <pre>Ruijie# show mac-address-learning</pre> <p>GigabitEthernet 0/1 learning ability: enable</p> <pre>Ruijie# show mac aging-time</pre> |

| | | | |
|---|-----------------------|---------------|----------------------------|
| Aging time : 180 seconds | | | |
| Ruijie# show mac-address-table dynamic interface GigabitEthernet 0/1 vlan 1 | | | |
| Vlan | MAC Address | Type | Interface |
| ----- | | | |
| 1 | 00d0.f800.1001 | STATIC | GigabitEthernet 1/1 |

Common Errors

Configure MAC address learning on an interface before configuring the interface as a layer-2 interface, for example, a switch port or an AP port.

2.4.2 Configuring a Static MAC Address

Configuration Effect

- Bind the MAC address of a network device with a port of a switch.

Configuration Steps

▾ Configuring a Static MAC address

- Optional.
- Bind the MAC address of a network device with a port of a switch.
-

| | |
|------------------------------|--|
| Command | mac-address-table static <i>mac-address</i> vlan <i>vlan-id</i> interface <i>interface-id</i> |
| Parameter Description | address <i>mac-address</i> : Specifies a MAC address. vlan <i>vlan-id</i> : Specifies a VLAN where the MAC address resides. interface <i>interface-id</i> : Specifies a physical interface or an AP port. |
| Defaults | By default, no static MAC address is configured. |
| Command Mode | Global configuration mode |
| Usage Guide | When the switch receives a packet containing the specified MAC address on the specified VLAN, the packet is forwarded to the bound interface. |

Verification

- Run the **show mac-address-table static** command to check whether the configuration takes effect.

| | |
|------------------------------|--|
| Command | show mac-address-table static [address <i>mac-address</i>] [interface <i>interface-id</i>] [vlan <i>vlan-id</i>] |
| Parameter Description | address <i>mac-address</i> : Specifies a MAC address. interface <i>interface-id</i> : Specifies a physical interface or an AP port. vlan <i>vlan-id</i> : Specifies a VLAN where the MAC address resides. |
| Command | Privileged EXEC mode/Global configuration mode /Interface configuration mode |

| Mode | | | | | | | | | | | | | | | | | |
|--------------------|--|--------|---------------------|------|-----------|---|----------------|--------|---------------------|---|----------------|--------|---------------------|---|----------------|--------|---------------------|
| Usage Guide | N/A | | | | | | | | | | | | | | | | |
| | <pre>Ruijie# show mac-address-table static</pre> <table border="1"> <thead> <tr> <th>Vlan</th> <th>MAC Address</th> <th>Type</th> <th>Interface</th> </tr> </thead> <tbody> <tr> <td>1</td> <td>00d0.f800.1001</td> <td>STATIC</td> <td>GigabitEthernet 1/1</td> </tr> <tr> <td>1</td> <td>00d0.f800.1002</td> <td>STATIC</td> <td>GigabitEthernet 1/1</td> </tr> <tr> <td>1</td> <td>00d0.f800.1003</td> <td>STATIC</td> <td>GigabitEthernet 1/1</td> </tr> </tbody> </table> | Vlan | MAC Address | Type | Interface | 1 | 00d0.f800.1001 | STATIC | GigabitEthernet 1/1 | 1 | 00d0.f800.1002 | STATIC | GigabitEthernet 1/1 | 1 | 00d0.f800.1003 | STATIC | GigabitEthernet 1/1 |
| Vlan | MAC Address | Type | Interface | | | | | | | | | | | | | | |
| 1 | 00d0.f800.1001 | STATIC | GigabitEthernet 1/1 | | | | | | | | | | | | | | |
| 1 | 00d0.f800.1002 | STATIC | GigabitEthernet 1/1 | | | | | | | | | | | | | | |
| 1 | 00d0.f800.1003 | STATIC | GigabitEthernet 1/1 | | | | | | | | | | | | | | |

Configuration Example

Configuring a Static MAC address

In the above example, the relationship of MAC addresses, VLAN and interfaces is shown in the following table.

| Role | MAC Address | VLAN ID | Interface ID |
|-----------------|----------------|---------|--------------|
| Web Server | 00d0.3232.0001 | VLAN2 | Gi0/10 |
| Database Server | 00d0.3232.0002 | VLAN2 | Gi0/11 |
| Administrator | 00d0.3232.1000 | VLAN2 | Gi0/12 |

Scenario
Figure 2-7

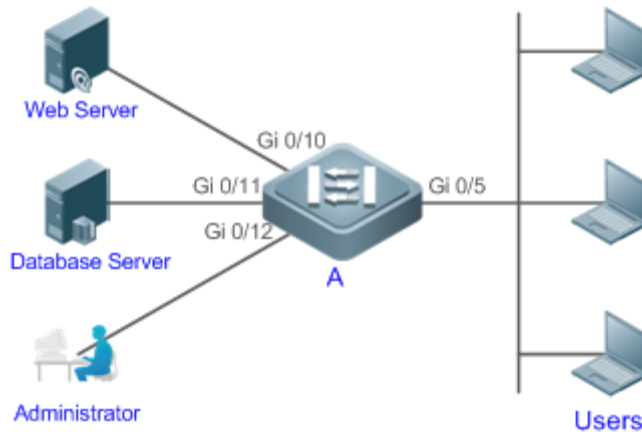

- Configuration Steps**
- Specify destination MAC addresses (*mac-address*).
 - Specify the VLAN (*vlan-id*) where the MAC addresses reside.
 - Specify interface IDs (*interface-id*).

A

```
A# configure terminal
A(config)# mac-address-table static 00d0.f800.3232.0001 vlan 2 interface gigabitEthernet 0/10
A(config)# mac-address-table static 00d0.f800.3232.0002 vlan 2 interface gigabitEthernet 0/11
A(config)# mac-address-table static 00d0.f800.3232.1000 vlan 2 interface gigabitEthernet 0/12
```

| Verification | Display the static MAC address configuration on a switch. | | | | | | | | | | | | | | | | |
|---------------------|---|--------|----------------------|------|-----------|---|---------------------|--------|----------------------|---|---------------------|--------|----------------------|---|---------------------|--------|----------------------|
| A | <pre>A# show mac-address-table static</pre> <table border="1"> <thead> <tr> <th>Vlan</th> <th>MAC Address</th> <th>Type</th> <th>Interface</th> </tr> </thead> <tbody> <tr> <td>2</td> <td>00d0.f800.3232.0001</td> <td>STATIC</td> <td>GigabitEthernet 0/10</td> </tr> <tr> <td>2</td> <td>00d0.f800.3232.0002</td> <td>STATIC</td> <td>GigabitEthernet 0/11</td> </tr> <tr> <td>2</td> <td>00d0.f800.3232.1000</td> <td>STATIC</td> <td>GigabitEthernet 0/12</td> </tr> </tbody> </table> | Vlan | MAC Address | Type | Interface | 2 | 00d0.f800.3232.0001 | STATIC | GigabitEthernet 0/10 | 2 | 00d0.f800.3232.0002 | STATIC | GigabitEthernet 0/11 | 2 | 00d0.f800.3232.1000 | STATIC | GigabitEthernet 0/12 |
| Vlan | MAC Address | Type | Interface | | | | | | | | | | | | | | |
| 2 | 00d0.f800.3232.0001 | STATIC | GigabitEthernet 0/10 | | | | | | | | | | | | | | |
| 2 | 00d0.f800.3232.0002 | STATIC | GigabitEthernet 0/11 | | | | | | | | | | | | | | |
| 2 | 00d0.f800.3232.1000 | STATIC | GigabitEthernet 0/12 | | | | | | | | | | | | | | |

Common Errors

- Configure a static MAC address before configuring the specific port as a layer-2 interface, for example, a switch port or an AP port.

2.4.3 Configuring a MAC Address for Packet Filtering

Configuration Effect

- If a device receives packets containing a source MAC address or destination MAC address specified as the filtered MAC address, the packets are discarded.

Configuration Steps

Configuring a MAC Address for Packet Filtering

- Optional.
- Perform this configuration to filter packets.
-

| | |
|---------------------|---|
| Command | mac-address-table filtering <i>mac-address</i> vlan <i>vlan-id</i> |
| Parameter | address <i>mac-address</i> : Specifies a MAC address. |
| Description | vlan <i>vlan-id</i> : Specifies a VLAN where the MAC address resides. |
| Defaults | By default, no filtered MAC address is configured. |
| Command Mode | Global configuration mode |
| Usage Guide | If a device receives packets containing a source MAC address or destination MAC address specified as the filtered MAC address, the packets are discarded. |

Verification

- Run the **show mac-address-table filter** command to display the filtered MAC address.

| | |
|--------------------|---|
| Command | show mac-address-table filter [address <i>mac-address</i>] [vlan <i>vlan-id</i>] |
| Parameter | address <i>mac-address</i> : Specifies a MAC address. |
| Description | vlan <i>vlan-id</i> : Specifies a VLAN where the MAC address resides. |

| Command Mode | Privileged EXEC mode/Global configuration mode /Interface configuration mode | | | | | | | | |
|---------------------|--|--------|-------------|------|-----------|---|----------------|--------|--|
| Usage Guide | N/A | | | | | | | | |
| | <pre>Ruijie# show mac-address-table filtering</pre> <table border="1"> <thead> <tr> <th>Vlan</th> <th>MAC Address</th> <th>Type</th> <th>Interface</th> </tr> </thead> <tbody> <tr> <td>1</td> <td>0000.2222.2222</td> <td>FILTER</td> <td></td> </tr> </tbody> </table> | Vlan | MAC Address | Type | Interface | 1 | 0000.2222.2222 | FILTER | |
| Vlan | MAC Address | Type | Interface | | | | | | |
| 1 | 0000.2222.2222 | FILTER | | | | | | | |

Configuration Example

Configuring a MAC Address for Packet Filtering

| Configuration Steps | <ul style="list-style-type: none"> Specify a destination MAC address (<i>mac-address</i>) for filtering. Specify a VLAN where the MAC addresses resides. | | | | | | | | |
|----------------------------|--|--------|-------------|------|-----------|---|---------------------|--------|--|
| | <pre>Ruijie# configure terminal Ruijie(config)# mac-address-table static 00d0.f800.3232.0001 vlan 1</pre> | | | | | | | | |
| Verification | Display the filtered MAC address configuration. | | | | | | | | |
| | <pre>Ruijie# show mac-address-table filter</pre> <table border="1"> <thead> <tr> <th>Vlan</th> <th>MAC Address</th> <th>Type</th> <th>Interface</th> </tr> </thead> <tbody> <tr> <td>1</td> <td>00d0.f800.3232.0001</td> <td>FILTER</td> <td></td> </tr> </tbody> </table> | Vlan | MAC Address | Type | Interface | 1 | 00d0.f800.3232.0001 | FILTER | |
| Vlan | MAC Address | Type | Interface | | | | | | |
| 1 | 00d0.f800.3232.0001 | FILTER | | | | | | | |

2.4.4 Configuring MAC Address Change Notification

Configuration Effect

- Monitor change of devices connected to a network device.

Configuration Steps

Configuring NMS

- Optional.
- Perform this configuration to enable an NMS to receive MAC address change notifications.
-

| | |
|------------------------------|--|
| Command | snmp-server host <i>host-addr</i> traps [version { 1 2c 3 [auth noauth priv] }] <i>community-string</i> |
| Parameter Description | <p>host <i>host-addr</i>: Specifies the IP address of a receiver.</p> <p>version { 1 2c 3 [auth noauth priv] }: Specifies the version of SNMP TRAP messages. You can also specify authentication and a security level for packets of Version 3.</p> |

| | |
|---------------------|---|
| | <i>community-string</i> : Indicates an authentication name. |
| Defaults | By default, the function is disabled. |
| Command Mode | Global configuration mode |
| Usage Guide | N/A |

↳ Enabling SNMP Trap

- Optional.
- Perform this configuration to send SNMP Trap messages.
-

| | |
|------------------------------|---------------------------------------|
| Command | snmp-server enable traps |
| Parameter Description | N/A |
| Defaults | By default, the function is disabled. |
| Command Mode | Global configuration mode |
| Usage Guide | N/A |

↳ Configuring Global MAC Address Change Notification

- Optional.
- If MAC address change notification is disabled globally, it is disabled on all interfaces.
-

| | |
|------------------------------|---|
| Command | mac-address-table notification |
| Parameter Description | N/A |
| Defaults | By default, MAC address change notification is disabled globally. |
| Command Mode | Global configuration mode |
| Usage Guide | N/A |

↳ Configuring MAC Address Change Notification On Interface

- Optional.
- Perform this configuration to enable MAC address change notification on an interface.
-

| | |
|------------------------------|---|
| Command | snmp trap mac-notification { added removed } |
| Parameter Description | added : Generates a notification when an MAC address is added. |

| | |
|---------------------|--|
| | removed: Generates a notification when an MAC address is deleted. |
| Defaults | By default, MAC address change notification is disabled on an interface. |
| Command Mode | Interface configuration mode |
| Usage Guide | N/A |

↘ Configuring Interval for Generating MAC Address Change Notifications and Volume of Notification History

- Optional.
- Perform this configuration to modify the interval for generating MAC address change notifications and the volume of notification history.
-

| | |
|------------------------------|--|
| Command | mac-address-table notification { interval <i>value</i> history-size <i>value</i> } |
| Parameter Description | interval <i>value</i>: (Optional) Indicates the interval for generating MAC address change notifications. The value ranges from 1 to 3600 seconds. history-size <i>value</i>: Indicates the maximum number of entries in the table of notification history. The value ranges from 1 to 200. |
| Defaults | The default interval is 1 second. The default maximum amount of notifications is 50. |
| Command Mode | Global configuration mode |
| Usage Guide | N/A |

Verification

- Run the **show mac-address-table notification** command to check whether the NMS receives MAC address change notifications.

| | |
|------------------------------|--|
| Command | show mac-address-table notification [interface [<i>interface-id</i>] history] |
| Parameter Description | Interface: Displays the configuration of MAC address change notification on all interfaces. <i>interface-id</i>: Displays the configuration of MAC address change notification on a specified interface. history: Displays the history of MAC address change notifications. |
| Command Mode | Privileged EXEC mode/Global configuration mode /Interface configuration mode |
| Usage Guide | N/A |
| Usage Guide | Display the configuration of global MAC address change notification. <pre>Ruijie#show mac-address-table notification MAC Notification Feature : Enabled Interval(Sec): 300 Maximum History Size : 50</pre> |

| Current History Size : 0 | |
|--------------------------|---|
| Field | Description |
| Interval(Sec) | Indicates the interval for generating MAC address change notifications. |
| Maximum History Size | Indicates the maximum number of entries in the table of notification history. |
| Current History Size | Indicates the current notification entry number. |

Configuration Example

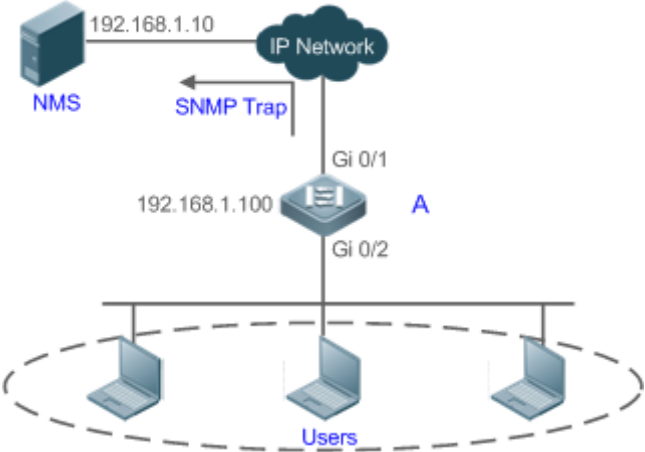
| | |
|---------------------------------------|--|
| <p>Scenario Figure 2-8</p> |  <p>The figure shows an intranet of an enterprise. Users are connected to A via port Gi0/2.</p> <p>The Perform the configuration to achieve the following effects:</p> <ul style="list-style-type: none"> ● When port Gi0/2 learns a new MAC address or finishes aging a learned MAC address, a MAC address change notification is generated. ● Meanwhile, A sends the MAC address change notification in an SNMP Trap message to a specified NMS. ● In a scenario where A is connected to a number of Users, the configuration can prevent MAC address change notification burst in a short time so as to reduce the network flow. |
| <p>Configuration Steps</p> | <ul style="list-style-type: none"> ● Enable global MAC address change notification on A, and configure MAC address change notification on port Gi0/2. ● Configure the IP address of the NMS host, and enable A with SNMP Trap. A communicates with the NMS via routing. ● Configure the interval for sending MAC address change notifications to 300 seconds (1 second by default). |
| <p>A</p> | <pre>Ruijie# configure terminal Ruijie(config)# mac-address-table notification Ruijie(config)# interface gigabitEthernet 0/2</pre> |

| | |
|----------------------------|---|
| | <pre>Ruijie(config-if-GigabitEthernet 0/2)# snmp trap mac-notification added Ruijie(config-if-GigabitEthernet 0/2)# snmp trap mac-notification removed Ruijie(config-if-GigabitEthernet 0/2)# exit Ruijie(config)# snmp-server host 192.168.1.10 traps version 2c comefrom2 Ruijie(config)# snmp-server enable traps Ruijie(config)# mac-address-table notification interval 300</pre> |
| <p>Verification</p> | <ul style="list-style-type: none"> ● Check t whether MAC address change notification is enabled globally . ● Check whether MAC address change notification is enabled on the interface. ● Display the MAC addresses of interfaces, and run the clear mac-address-table dynamic command to simulate aging dynamic MAC addresses. ● Check whether global MAC address change notification is enabled globally. ● Display the history of MAC address change notifications. |
| <p>A</p> | <pre>Ruijie# show mac-address-table notification MAC Notification Feature : Enabled Interval(Sec): 300 Maximum History Size : 50 Current History Size : 0 Ruijie# show mac-address-table notification interface GigabitEthernet 0/2 Interface MAC Added Trap MAC Removed Trap ----- - GigabitEthernet 0/2 Enabled Enabled Ruijie# show mac-address-table interface GigabitEthernet 0/2 Vlan MAC Address Type Interface ----- 1 00d0.3232.0001 DYNAMIC GigabitEthernet 0/2 Ruijie# show mac-address-table notification MAC Notification Feature : Enabled Interval(Sec): 300 Maximum History Size : 50 Current History Size : 1 Ruijie# show mac-address-table notification history History Index : 0</pre> |

```

Entry Timestamp: 221683
MAC Changed Message :
Operation:DEL Vlan:1 MAC Addr: 00d0.3232.0003 GigabitEthernet 0/2

```

2.5 Monitoring

Clearing

 Running the clear commands may lose vital information and interrupt services.

| Description | Command |
|-------------------------------|--|
| Clears dynamic MAC addresses. | clear mac-address-table dynamic [address <i>mac-address</i>] [interface <i>interface-id</i>] [vlan <i>vlan-id</i>] |

Displaying

| Description | Command |
|---|--|
| Displays the MAC address table. | show mac-address-table { dynamic static filter } [address <i>mac-address</i>] [interface <i>interface-id</i>] [vlan <i>vlan-id</i>] |
| Displays the aging time for dynamic MAC addresses. | show mac-address-table aging-time |
| Displays the configuration and history of MAC address change notifications. | show mac-address-table notification [interface [<i>interface-id</i>]] history] |

Debugging

 System resources are occupied when debugging information is output. Therefore, disable debugging immediately after use.

| Description | Command |
|-------------------------------|-------------------------|
| Debugs MAC address operation. | debug bridge mac |

3 Configuring VLAN

3.1 Overview

A Virtual Local Area Network (VLAN) is a logical network created based on a physical network. A VLAN can be categorized into Layer-2 networks of the OSI model.

A VLAN has the same properties as a common LAN, except for physical location limitation. Unicast, broadcast and multicast frames of Layer 2 are forwarded and transmitted within a VLAN, keeping traffic segregated.

We may define a port as a member of a VLAN, and all terminals connected to this port are parts of a virtual network that supports multiple VLANs. You do not need to adjust the network physically when adding, removing and modifying users. Communication among VLANs is realized through Layer-3 devices, as shown in the following figure.

Protocols and Standards

- IEEE 802.1Q

3.2 Applications



N/A

3.3 Features



Basic Concepts

↳ VLAN

A VLAN is a logical network created based on a physical network. A VLAN has the same properties as a common LAN, except for physical location limitation. Unicast, broadcast and multicast frames of Layer 2 are forwarded and transmitted within a VLAN, keeping traffic segregated.

-  The VLANs supported by Ruijie products comply with the IEEE802.1Q standard. A maximum of 4094 VLANs (VLAN ID 1-4094) are supported, among which VLAN 1 cannot be deleted.
-  The configurable VLAN IDs are from 1 to 4094.
-  In case of insufficient hardware resources, the system returns information on VLAN creation failure.

3.4 Configuration

| Configuration | Description and Command |
|--|---|
| Configuring Basic VLAN |  (Mandatory) It is used to create a VLAN. |
| | vlan Enters a VLAN ID. |
| |  (Optional) It is used to rename a VLAN. |
| | name Names a VLAN. |

3.4.1 Configuring Basic VLAN

Configuration Effect

- A VLAN is identified by a VLAN ID. You may add, delete, modify VLANs 2 to 4094, but VLAN 1 is created automatically and cannot be deleted. You may configure the port mode, and add or remove a VLAN.

Notes

- N/A

Configuration Steps

↳ Creating and Modifying a VLAN

- Mandatory.
- In case of insufficient hardware resources, the system returns information on VLAN creation failure.
- Use the `vlan vlan-id` command to create a VLAN or enter VLAN mode.

| | |
|------------------------------|---|
| Command | <code>vlan <i>vlan-id</i></code> |
| Parameter Description | <i>vlan-id</i> : indicates VLAN ID ranging from 1 to 4094. |
| Defaults | VLAN 1 is created automatically and is not deletable. |
| Command Mode | Global configuration mode |
| Usage Guide | If you enter a new VLAN ID, the corresponding VLAN will be created. If you enter an existing VLAN ID, the corresponding VLAN will be modified. You may use the no vlan <i>vlan-id</i> command to delete a VLAN. The undeletable VLANs include VLAN1, the VLANs configured with SVIs, and SubVLANs. |

↘ **Renaming a VLAN**

- Optional.
- You cannot rename a VLAN the same as the default name of another VLAN.

| | |
|------------------------------|--|
| Command | <code>name <i>vlan-name</i></code> |
| Parameter Description | <i>vlan-name</i> : indicates a VLAN name. |
| Defaults | By default, the name of a VLAN is its VLAN ID. For example, the default name of the VLAN 4 is VLAN 0004. |
| Command Mode | VLAN configuration mode |
| Usage Guide | To restore the VLAN name to defaults, use the no name command. |

Verification

- Use commands **show vlan** and **show interface switchport** to check whether the configuration takes effect.

| | |
|------------------------------|--|
| Command | <code>show vlan [id <i>vlan-id</i>]</code> |
| Parameter Description | <i>vlan-id</i> : indicates a VLAN ID. |
| Command Mode | Any mode |
| Usage Guide | N/A |
| Command Display | <pre>Ruijie(config-vlan)#show vlan id 20 VLAN Name Status Ports ----- 20 VLAN0020 STATIC Gi0/1</pre> |

Configuration Example

↘ **Configuring Basic VLAN and Access Port**

| Configuration Steps | <ul style="list-style-type: none"> ● Create a VLAN and rename it. | | | | | | | | | | | | |
|----------------------------|--|--------------|--------|-------|------------|--------|--|--------------------|---------------|--------------|--------------------|---------------|--|
| | <pre>Ruijie# configure terminal Ruijie(config)# vlan 888 Ruijie(config-vlan)# name test888</pre> | | | | | | | | | | | | |
| Verification | Check whether the configuration is correct. | | | | | | | | | | | | |
| | <pre>Ruijie(config-vlan)#show vlan</pre> <table border="1" style="width: 100%; border-collapse: collapse;"> <thead> <tr> <th style="text-align: left;">VLAN Name</th> <th style="text-align: left;">Status</th> <th style="text-align: left;">Ports</th> </tr> </thead> <tbody> <tr> <td>1 VLAN0001</td> <td>STATIC</td> <td></td> </tr> <tr> <td>20 VLAN0020</td> <td>STATIC</td> <td>Gi0/3</td> </tr> <tr> <td>888 test888</td> <td>STATIC</td> <td></td> </tr> </tbody> </table> | VLAN Name | Status | Ports | 1 VLAN0001 | STATIC | | 20 VLAN0020 | STATIC | Gi0/3 | 888 test888 | STATIC | |
| VLAN Name | Status | Ports | | | | | | | | | | | |
| 1 VLAN0001 | STATIC | | | | | | | | | | | | |
| 20 VLAN0020 | STATIC | Gi0/3 | | | | | | | | | | | |
| 888 test888 | STATIC | | | | | | | | | | | | |

3.5 Monitoring

Displaying

| Description | Command |
|------------------------------|------------------|
| Displays VLAN configuration. | show vlan |

Debugging

 System resources are occupied when debugging information is output. Disable the debugging switch immediately after use.

| Description | Command |
|---------------|--------------------------|
| Debugs VLANs. | debug bridge vlan |

4 Configuring VLAN Group

4.1 Overview

Each virtual LAN (VLAN) group contains multiple VLANs. VLAN group function associates a wireless LAN (WLAN) with a VLAN group, achieving 1:N mapping between them, which assigns VLANs flexibly to WLAN-accessed stations (STAs).

There are two primary VLAN assignment modes:

- After STAs pass 802.1X authentication, the authentication server assigns VLANs to STAs.

Protocols and Standards

- N/A

4.2 Applications

- N/A

4.3 Features

Basic Concepts

↘ VLAN Group

Multiple VLANs are added to a VLAN group. When STAs access a WLAN, VLANs are assigned to the STAs based on the VLAN assignment mode of the VLAN group mapped to the current WLAN.

↘ VLAN Assignment Mode

Each VLAN group can assign VLANs based on 802.1X.

Overview

| Feature | Description |
|--|--|
| 802.1X-based VLAN Assignment | You can plan VLANs to be assigned after STAs pass 802.1X authentication. |



4.3.1 802.1X-based VLAN Assignment

Working Principle

Before authentication, an STA belongs to the default VLAN of a VLAN group mapped to the currently accessed WLAN.

The STA will be authenticated in the default VLAN. After authentication succeeds, the authentication server determines whether to assign a VLAN. If yes, the packets subsequently sent by the STA will be automatically redirected to the assigned VLAN. If no, the packets will be transmitted in the default VLAN of the VLAN group.

4.4 Configuration

| Configuration | Description and Command | |
|---|--|--|
| Configuring a VLAN Group |  (Mandatory) It is used to create a VLAN group and configure a VLAN list, the VLAN assignment mode, and default VLAN. | |
| | vlan-group <i>group-id</i> | Creates a VLAN group. |
| | vlan-list <i>vlan-list</i> | Configures a VLAN list for a VLAN group. |
| | vlan-assign-mode <i>XX</i> | Specifies the VLAN assignment mode for a VLAN group. |
| Configuring WLAN-VLAN Group Mapping |  (Mandatory) It is used to configure the mapping between a WLAN and a VLAN group. | |
| | dot11 wlan <i>wlan-id</i> vlan-group <i>group-id</i> | Configures WLAN-VLAN group mapping on APs. |

4.4.1 Configuring a VLAN Group

Configuration Effect

- Create a VLAN group and complete configurations related to the VLAN group.

Notes

- N/A

Configuration Steps

📄 Creating a VLAN Group

- Mandatory.

📄 Configuring a VLAN List for a VLAN Group

- Mandatory. Ensure that VLANs have been created.

📄 Configuring the VLAN Assignment Mode for a VLAN Group

- Mandatory.
- Use this command to implement the VLAN assignment policy of a VLAN group.

➤ **Configuring the Default VLAN for a VLAN Group**

- Mandatory in 802.1X-based assignment mode.
- The default VLAN takes effect when the current WLAN is in 802.1X-based assignment mode, that is, when the authentication server assigns the default VLAN before 802.1X authentication succeeds.

Verification

- Check the configurations of the VLAN group.

Configuration Example

➤ **Configuring a VLAN Group**

| | |
|-----------------------------------|---|
| <p>Configuration Steps</p> | <ul style="list-style-type: none"> ● Create VLAN Group 10. ● Set the VLAN assignment mode to dot1X mode. ● Configure a VLAN list that contains VLAN 1 to VLAN 10. ● Set the default VLAN to VLAN 1. |
| | <pre>Ruijie# configure terminal Ruijie(config)# vlan-group 10 Ruijie(config-vlan-group)# vlan-assign-mode dot1x Ruijie(config-vlan-group)# vlan-list 1-10 Ruijie(config-vlan-group)# default-vlan 1 Ruijie(config-vlan-group)# end</pre> |
| <p>Verification</p> | <ul style="list-style-type: none"> ● Check whether the configurations of VLAN Group 10 are correct. |
| | <pre>Ruijie#show vlan-group 10 vlan-group id mode default-vlan vlan-list ----- 10 dot1x 1 1-10</pre> |

Common Errors

- A VLAN configured in a VLAN list does not exist.
- The default VLAN configured does not exist in the VLAN list.

 The ID of a created VLAN group ranges from 1 to 128.

 A VLAN group contains a maximum of 128 VLANs.

4.4.2 Configuring WLAN-VLAN Group Mapping

Configuration Effect

- Configure the mapping between a WLAN and a VLAN group so that STAs can be associated with the WLAN.

Notes

- N/A

Configuration Steps

📌 Configure WLAN-VLAN Group Mapping

- Mandatory.

Verification

- Check whether the mapping between a WLAN and a VLAN group is correct.

Configuration Example

📌 Configure WLAN-VLAN Group Mapping

| | |
|----------------------------|--|
| Configuration Steps | <ul style="list-style-type: none"> ● Create a WLAN. ● Configure the WLAN-VLAN group mapping. ● Configure the VLAN group encapsulation for wireless sub interfaces. |
| | <pre>Ruijie(config)# dot11 wlan 100 Ruijie(dot11-wlan-config)# vlan-group-id 100 Ruijie(dot11-wlan-config)# end Ruijie(config)# interface dot11radio 1/0.1 Ruijie(config-subif)# encapsulation dot1Q group 10 Ruijie(config-subif)# end Ruijie(config)# interface dot11radio 1/0 Ruijie(config-if-Dot11radio 1/0)# wlan-id 100</pre> |
| Verification | <ul style="list-style-type: none"> ● Run the show running command to check whether the configurations are correct. |

Common Errors

- N/A

4.5 Monitoring

Clearing

N/A

Displaying

| Description | Command |
|--------------------------------------|--|
| Displays the VLAN group information. | show vlan-group [<i>group-id</i>] |

Debugging

 System resources are occupied when debugging information is output. Therefore, disable the debugging switch immediately after use.

| Description | Command |
|-------------------------------|---------------------------|
| Debugs the VLAN group status. | debug bridge vgoup |

5 Configuring RLDP

5.1 Overview

The Rapid Link Detection Protocol (RLDP) achieves rapid detection of unidirectional link failures, directional forwarding failures and downlink loop failures of an Ethernet. When a failure is found, relevant ports will be closed automatically according to failure treatment configuration or the user will be notified to manually close the ports to avoid wrong flow forwarding or an Ethernet layer-2 loop.

5.2 Applications

| Application | Description |
|--|---------------------------------------|
| Unidirectional Link Detection | Detect a unidirectional link failure. |
| Bidirectional Forwarding Detection | Detect a bidirectional link failure. |
| Downlink Loop Detection | Detect a link loop. |

5.2.1 Unidirectional Link Detection

Scenario

As shown in the following figure, A is connected to B via optical fiber. The two lines are the Tx and Rx lines of optical fiber. Unidirectional link detection is enabled on A and B. If any of the Tx of Port A, Rx of Port B, Tx of Port B and Rx of Port A fails, a unidirectional failure will be detected and treated under the RLDP. If the failure is eliminated, the administrator may manually restore the RLDP on A and B and resume detection.

Figure 5-1

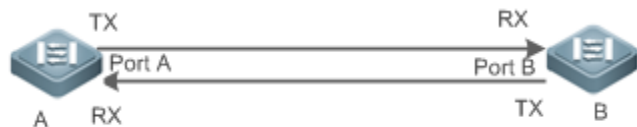

| | |
|----------------|---|
| Remarks | <p>A and B are layer-2 or layer-3 switches.</p> <p>The Tx of Port A of A is connected to the Rx of Port B of B.</p> <p>The Rx of Port A of A is connected to the Tx of Port B of B.</p> |
|----------------|---|

Deployment

- Global RLDP is enabled.
- Configure unidirectional link detection under Port A and Port B and define a method for failure treatment.

5.2.2 Bidirectional Forwarding Detection

Scenario

As shown in the following figure, A is connected to B via optical fiber, and the two lines are Tx and Rx lines of optical fiber. Unidirectional link detection is enabled on A and B. If the Tx of Port A, Rx of Port B, Rx of Port A and Tx of Port B all fail, a bidirectional failure will be detected and treated under the RLDP. If the failure is eliminated, the administrator may manually restore the RLDP on A and B and resume detection.

Figure 5-2



| | |
|----------------|---|
| Remarks | <p>A and B are layer-2 or layer-3 switches.</p> <p>The Tx of Port A of A is connected to the Rx of Port B of B.</p> <p>The Rx of Port A of A is connected to the Tx of Port B of B.</p> |
|----------------|---|

Deployment

- Global RLDP is enabled.
- Configure BFD under Port A and Port B and define a method for failure treatment.

5.2.3 Downlink Loop Detection

Scenario

As shown in the following figure, A, B and C are connect into a loop. Downlink loop detection is enabled on A, and a loop is detected and treated.

Figure 5-3

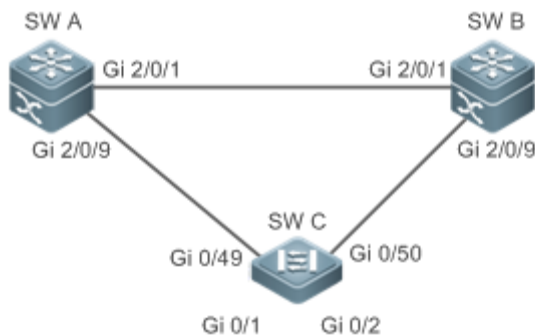

| | |
|----------------|---|
| Remarks | <p>A, B and C are layer-2 or layer-3 switches.</p> <p>A, B and C are interconnected via exchange ports.</p> |
|----------------|---|

Deployment

- Global RLDP is enabled on A.
- Configure downlink loop detection on the Gi 2/0/1 and Gi 2/0/9 ports of A, and define a method for failure treatment.

5.3 Features

Most Ethernet link detection mechanisms detect link connectivity through automatic physical-layer negotiation. However, in some cases devices are connected on the physical layer and operate normally but layer-2 link communication is disabled or abnormal. The RLDP recognizes a neighbor device and detects a link failure through exchanging Prob packets, Echo packets or Loop packets with the device.

Basic Concepts

↘ Unidirectional Link Failure

A unidirectional link failure occurs in case of a cross-connected optical fiber, a disconnected optical fiber, an open-circuit optical fiber, one open-circuit line in a twisted-pair cable, or unidirectional open circuit of an intermediate device between two devices. In such cases, one end of a link is connected and the other disconnected so that flow is forwarded wrongly or a loop guard protocol (for example, the STP) fails.

↘ Bidirectional Link Failure

A bidirectional link failure occurs in case of two optical fibers, two open-circuit lines in a twisted-pair cable, or bidirectional open circuit of an intermediate device between two devices. In such cases, the both ends of a link are disconnected so that flow is forwarded wrongly.

↘ Loop Failure

A downlink device is wrongly connected to form a loop, resulting in a broadcast storm.

↘ RLDP Packet

The RLDP defines three types of packets: Prob packets, Echo packets and Loop packets.

- Prob packets are layer-2 multicast packets for neighbor negotiation, and unidirectional or bidirectional link detection. The default encapsulation format is SNAP, which changes automatically to EthernetII if a neighbor sends EthernetII packets.
- Echo packets are layer-2 unicast packets as response to Prob packets and used for unidirectional or bidirectional link detection. The default encapsulation format is SNAP, which changes automatically to EthernetII if a neighbor sends EthernetII packets.
- Loop packets are layer-2 multicast packets for downlink loop detection. They can only be received. The default encapsulation format is SNAP.

↘ RLDP Detection Interval and Maximum Detection Times

A detection interval and the maximum detection times can be configured for the RLDP. A detection interval determines the period of sending Prob packets and Loop packets. When a device receives a Prob packet, it replies with an Echo packet immediately. A detection interval and the maximum detection times determine the maximum detection time (equal to a detection interval × the maximum detection times + 1) for unidirectional or bidirectional link detection. If neither Prob nor Echo packet from a neighbor can be received within the maximum detection time, the treatment of unidirectional or bidirectional failure will be triggered.

↘ RLDP Neighbor Negotiation

When configured with unidirectional or bidirectional link detection, a port can learn a peer-end device as its neighbor. One port may learn one neighbor, which is variable. If negotiation is enabled, unidirectional or bidirectional link detection starts after a port finds a neighbor through negotiation, which succeeds when a port receives a Prob packet from the neighbor. However, if the RLDP is enabled under a failure, the port cannot learn a neighbor so that detection cannot start. In this case, recover the link state before enabling the RLDP.

↘ Treatment for Failed Port under RLDP

- Warning: Only print Syslog to indicate a failed port and a failure type.
- Shutdown SVI: Print Syslog, and then inquire an SVI according to the Access VLAN or Native VLAN of a port and shut down the SVI if the port is a physical exchange port or layer-2 AP member port.
- Port violation: Print Syslog, and configure a failed port as in violation state, and the port will enter Linkdown state physically.
- Block: Print Syslog, and configure the forward state of a port as Block, and the port will not forward packets.

↘ Recovery of Failed Port under RLDP

- Manual reset: Manually reset all failed ports to initialized state and restart link detection.
- Manual or automatic errdisable recovery: Recover all failed ports to initialized state manually or regularly (30s by default and configurable) and restart link detection.
- Automatic recovery: Under unidirectional or bidirectional link detection, if the treatment for failed ports is not specified as port violation, recover ports to initialized state based on Prob packets and restart link detection.

↘ Port State under RLDP

- normal: Indicates the state of a port after link detection is enabled.
- error: Indicates the state of a port after a unidirectional or bidirectional link failure or a loop failure is detected.

↘ Overview

| Feature | Description |
|---------|-------------|
|---------|-------------|

| | |
|--|--|
| Deploying RLDP Detection | Enable unidirectional or bidirectional link detection or downlink loop detection for failures and implement treatment. |
|--|--|

5.3.1 Deploying RLDP Detection

The RLDP provides unidirectional link detection, bidirectional forwarding detection and downlink loop detection.

Working Principle

Unidirectional Link Detection

When this function is enabled, a port sends Prob packets and receives Echo packets from a neighbor regularly as well as receiving Prob packets from a neighbor and replying with Echo packets. Within the maximum detection time, if the port receives Prob packets but no Echo packets, or none of them, treatment for a unidirectional failure will be triggered and detection will stop.

Bidirectional Forwarding Detection

When this function is enabled, a port sends Prob packets and receives Echo packets from a neighbor regularly as well as receiving Prob packets from a neighbor and replying with Echo packets. Within the maximum detection time, if the port receives neither Prob packets nor Echo packets from a neighbor, treatment for a bidirectional failure will be triggered and detection will stop.

Downlink Loop Detection

When this function is enabled, a port sends Loop packets regularly. In the following cases, a loop failure will be triggered after the same port or a different port receives the packets: in one case, the egress and ingress ports are the same routed port or layer-3 AP member port; in another case, the egress and ingress ports are exchange ports or layer-2 AP member ports in a same default VLAN and in Forward state. Treatment for the failure will be implemented and detection will stop.

Related Configuration

- Configuring RLDP Detection



By default, RLDP detection is disabled.

You may run the global command **rdp enable** or the interface command **rdp port** to enable RLDP detection and specify a detection type and treatment.

You may run the **rdp neighbor-negotiation** command to neighbor negotiation, the **rdp detect-interval** to specify a detection interval, the **rdp detect-max** to specify detection times, or the **rdp reset** to recover a failed port.

5.4 Configuration

| Configuration | Description and Command | |
|--|--|---|
| Configuring Basic RLDP Functions |  (Mandatory) It is used to enable RLDP detection under global configuration mode. | |
| | rdp enable | Enables global RLDP detection on all ports. |

| | |
|--|---|
|  (Mandatory) It is used to specify under interface configuration mode a detection type and failure treatment for an interface. | |
| rldp port | Enables RLDP detection on a port and specifies a detection type and failure treatment. |
|  (Optional) It is used to configure a detection interval, detection times and neighbor negotiation under global configuration mode. | |
| rldp detect-interval | Modifies global RLDP parameters on all ports, such as the detection interval, maximum detection times and neighbor negotiation. |
| rldp detect-max | |
| rldp neighbor-negotiation | |
|  (Optional) It is used under privileged mode. | |
| rldp reset | Recovers all ports. |

5.4.1 Configuring Basic RLDP Functions

Configuration Effect

- Enable RLDP unidirectional link detection, bidirectional forwarding detection, or downlink loop detection to discover failures.

Notes

- Loop detection is effective to all member ports of an AP when configured on one of the ports. Unidirectional link detection and bidirectional forwarding detection are effective only on an AP member port.
- The loop detection on a physical port added to an AP shall be configured the same as that of the other member ports. There are two cases. First, if loop detection is not configured on a newly-added port but on the existing member ports, the new port adopts the configuration and detection results of the existing ports. Second, if a newly-added port and the existing member ports have different loop detection configuration, the new port adopts the configuration and detection results of the existing ports.
- When configuring the RLDP on an AP port, you may configure failure treatment only as "shutdown-port", to which other configurations will be modified.
- When "shutdown-port" is configured on a port, RLDP detection cannot be restored in case of a failure. After troubleshooting, you may run the **rldp reset** or **errdisable recovery** command to restore the port and resume detection. For configuration of the **errdisable recovery** command, please refer to the *Configuring Interface.doc*.

Configuration Steps

↘ Enabling RLDP

- Mandatory.
- Enable RLDP detection on all ports under global configuration mode.

↘ Enabling Neighbor Negotiation

- Optional.
- Enable the function under global configuration mode, and port detection will be started under successful neighbor negotiation.

↘ Configuring Detection Interval

- Optional.
- Specify a detection interval under global configuration mode.

↘ Configuring Maximum Detection Times

- Optional.
- Specify the maximum detection times under global configuration mode.

↘ Configuring Detection under Port

- Mandatory.
- Configure unidirectional RLDP detection, bidirectional RLDP detection or downlink loop detection under interface configuration mode, and specify failure treatment.

↘ Restoring All Failed Ports

- Optional.
- Enable this function under privileged mode to restore all failed ports and resume detection.

Verification

- Display the information of global RLDP, port and neighbor.

Related Commands

↘ Enabling Global RLDP Detection

| | |
|---------------------|---------------------------|
| Command | rldp enable |
| Parameter | N/A |
| Description | |
| Command Mode | Global configuration mode |

| | |
|--------------------|-------------------------------|
| Usage Guide | Enable global RLDP detection. |
|--------------------|-------------------------------|

↘ Enabling RLDP Detection on Interface

| | |
|------------------------------|---|
| Command | <code>rldp port { unidirection-detect bidirection-detect loop-detect } { warning shutdown-svi shutdown-port block }</code> |
| Parameter Description | <p>unidirection-detect: Indicates unidirectional link detection.</p> <p>bidirection-detect: Indicates bidirectional forwarding detection.</p> <p>loop-detect: Indicates downlink loop detection.</p> <p>warning: Indicate the failure treatment is warning.</p> <p>shutdown-svi: Indicate the failure treatment is closing the SVI that the interface is on.</p> <p>shutdown-port: Indicates the failure treatment is port violation.</p> <p>block: Indicates the failure treatment is disabling learning and forwarding of a port.</p> |
| Command Mode | Interface configuration mode |
| Usage Guide | <p>The interfaces include layer-2 switch ports, layer-3 routed ports, layer-2 AP member ports, and layer-3 AP member ports.</p> <p>Ports on which RLDP is enabled to handle downlink loop failures are random. For example, RLDP downlink loop detection is configured on both downlink ports A and B, and the configured failure handling mode of port A is warning while that of port B is shutdown-port. When there is a downlink loop between port A and port B, port A may detect the downlink loop failure prior to port B. After port A completes failure handling according to the configuration, it no longer sends packets to detect the downlink loop status. Port B fails to detect the downlink loop failure because it does not receive a loop detection packet from port A, but the downlink loop actually persists. If a detected downlink loop needs to be actually removed in application scenarios, downlink ports in the same loop must be restricted to use a consistent loop failure handling mode and the loop failure handling mode cannot be warning.</p> |

↘ Modifying Global RLDP Detection Parameters

| | |
|------------------------------|--|
| Command | <code>rldp {detect-interval <i>interval</i> detect-max <i>num</i> neighbor-negotiation }</code> |
| Parameter Description | <p>detect-interval <i>interval</i>: Indicates a detection interval.</p> <p>detect-max <i>num</i>: Indicates detection times.</p> <p>neighbor-negotiation: Indicates neighbor negotiation.</p> |
| Command Mode | Global configuration mode |
| Usage Guide | Modify all RLDP parameters on all ports when necessary. |

↘ Recovering Failed Port

| | |
|------------------------------|-------------------------|
| Command | <code>rldp reset</code> |
| Parameter Description | N/A |
| Command | Privileged mode |

| | |
|--------------------|---|
| Mode | |
| Usage Guide | Recover all failed ports to initialized state and resume detection. |

📄 **Displaying RLDP State Information**

| | |
|------------------------------|---|
| Command | <code>show rldp [interface interface-name]</code> |
| Parameter Description | <i>interface-name</i> : Indicates the interface to display information of. |
| Command Mode | Privileged mode, global configuration mode, or interface configuration mode |
| Usage Guide | Display RLDP state information. |

Configuration Example

📄 **Enabling RLDP Detection in Ring Topology**

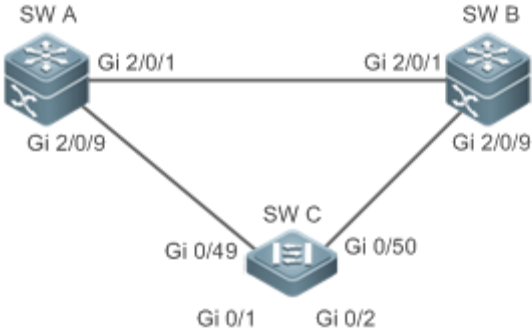
| | |
|---|--|
| <p>Scenario</p> <p>Figure 5-4</p> | <p>As shown in the following figure, the aggregation and access sections are in a ring topology. The STP is enabled on all devices to prevent loop and provide redundancy protection. To avoid a unidirectional or bidirectional link failure resulting in STP failure, RLDP unidirectional and bidirectional link detection is enabled between aggregation devices as well as between an aggregation device and the access device. To avoid loop due to wrong downlink connection of the aggregation devices, enable RLDP downlink loop detection on the downlink ports of the aggregation devices and of the access device. To avoid loop due to wrong downlink connection of the access device, enable RLDP downlink loop detection on the downlink ports of the access device.</p>  |
| <p>Configuration Steps</p> | <ul style="list-style-type: none"> ● SW A and SW B are aggregation devices, and SW C is an access device. Users connected to SW C. SW A, SW B and SW C are structured in a ring topology, and the STP is enabled on each of them. For STP configuration, refer to relevant configuration guide. ● Enable the RLDP on SW A, enable unidirectional and bidirectional link detection on the two ports, and enable loop detection on the downlink port. ● Enable the RLDP on SW B, enable unidirectional and bidirectional link detection on the two ports, and enable loop detection on the downlink port. ● Enable the RLDP on SW C, enable unidirectional and bidirectional link detection on the two uplink ports, and enable loop detection on the two downlink ports. |

| | |
|---------------------|--|
| A | <pre> A#configure terminal A(config)#rldp enable A(config)#interface GigabitEthernet 2/0/1 A(config-if-GigabitEthernet 2/0/1)#rldp port unidirection-detect shutdown-port A(config-if-GigabitEthernet 2/0/1)#rldp port bidirection-detect shutdown-port A(config-if-GigabitEthernet 2/0/1)# exit A(config)#interface GigabitEthernet 2/0/9 A(config-if-GigabitEthernet 2/0/1)#rldp port unidirection-detect shutdown-port A(config-if-GigabitEthernet 2/0/1)#rldp port bidirection-detect shutdown-port A(config-if-GigabitEthernet 2/0/1)#rldp port loop-detect shutdown-port A(config-if-GigabitEthernet 2/0/1)#exit </pre> |
| B | <p>Apply the configuration on SW A.</p> |
| C | <pre> C#configure terminal C(config)#rldp enable C(config)#interface GigabitEthernet 0/49 C(config-if-GigabitEthernet 0/49)#rldp port unidirection-detect shutdown-port C(config-if-GigabitEthernet 0/49)#rldp port bidirection-detect shutdown-port C(config-if-GigabitEthernet 0/49)# exit C(config)#interface GigabitEthernet 0/50 C(config-if-GigabitEthernet 0/50)#rldp port unidirection-detect shutdown-port C(config-if-GigabitEthernet 0/50)#rldp port bidirection-detect shutdown-port C(config-if-GigabitEthernet 0/50)#exit C(config)#interface GigabitEthernet 0/1 C(config-if-GigabitEthernet 0/1)# rldp port loop-detect shutdown-port C(config-if-GigabitEthernet 0/1)#exit C(config)#interface GigabitEthernet 0/2 C(config-if-GigabitEthernet 0/2)# rldp port loop-detect shutdown-port C(config-if-GigabitEthernet 0/2)#exit </pre> |
| Verification | <ul style="list-style-type: none"> ● Check the RLDP information on SW A, SW B and SW C. Take SW A for example. |
| A | <pre> A#show rldp rldp state : enable </pre> |

```
rldp hello interval: 3
rldp max hello      : 2
rldp local bridge   : 00d0.f822.33aa
-----
Interface GigabitEthernet 2/0/1
port state          : normal
neighbor bridge     : 00d0.f800.51b1
neighbor port       : GigabitEthernet 2/0/1
unidirection detect information:
    action: shutdown-port
    state : normal
bidirection detect information:
    action: shutdown-port
    state : normal

Interface GigabitEthernet 2/0/9
port state          : normal
neighbor bridge     : 00d0.f800.41b0
neighbor port       : GigabitEthernet 0/49
unidirection detect information:
    action: shutdown-port
    state : normal
bidirection detect information:
    action: shutdown-port
    state : normal
loop detect information:
    action: shutdown-port
    state : normal
```

Common Errors

- RLDP functions and private multicast address authentication or TPP are enabled at the same time.
- Neighbor negotiation is not enabled when configuring unidirectional or bidirectional link detection. The RLDP should be enabled on a neighbor device, or otherwise a unidirectional or bidirectional failure will be detected.

- If RLDP detection is configured to be implemented after neighbor negotiation while configuring unidirectional or bidirectional link detection, detection cannot be implemented as no neighbor can be learned due to a link failure. In this situation, you are suggested to recover the link state first.
- You are suggested not to specify the failure treatment as Shutdown SVI under a routed port.
- You are suggested not to specify the failure treatment as Block for a port, on which a loop protection protocol is enabled, for example, the STP.

➤ **Configuring RLDP Loop Detection on Wireless APs**

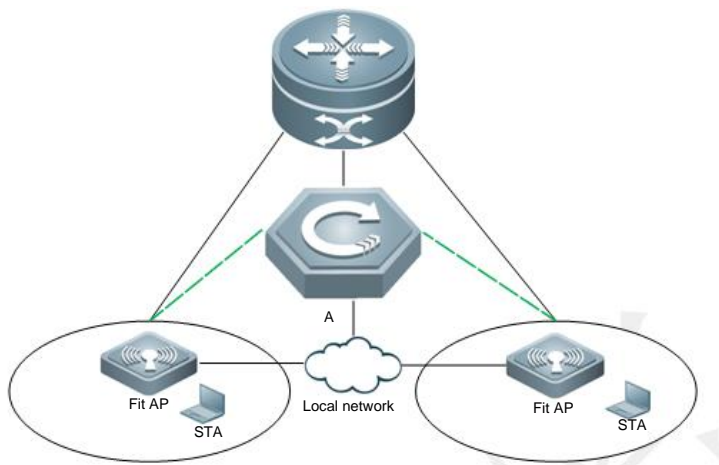
| | |
|--|--|
| <p>Scenario Figure 5-5</p> | <p>As shown in the following figure, a large number of APs exist in the wireless AP scenario. If the RLDP loop detection function is configured and modified on APs one by one, the workload is heavy. The RLDP loop detection configurations can be pushed from the AC device to all online APs (or an independent AP).</p>  |
| <p>Configuration Steps</p> | <ul style="list-style-type: none"> ● Log in to the AC device and enter the AP configuration mode. ● Enable the RLDP loop detection function on the wired ports of the corresponding AP. ● Enable the RLDP function on corresponding APs in global configuration mode. ● On corresponding APs, configure the recovery time for the RLDP violated port. |
| <p>A</p> | <pre>A#configure terminal A(config)#ap-config all A(config-ap)#exec-cmd mode "int gi 0/1" cmd "rldp port loop-detect shutdown-port" A(config-ap)#exec-cmd mode configure cmd "rldp enable" A(config-ap)#exec-cmd mode configure cmd "errdisable recovery interval 600"</pre> |
| <p>Verification</p> | <ul style="list-style-type: none"> ● On the AC device, check the RLDP loop detection configurations. |
| <p>A</p> | <pre>A# show run ! ap-config all exec-cmd mode "int gi 0/1" cmd "rldp port loop-detect shutdown-port"</pre> |

```
exec-cmd mode configure cmd "rldp enable"  
exec-cmd mode configure cmd "errdisable recovery interval 600"  
!
```

Common Errors

- When the **exec-cmd** command is executed for interface configuration, the input of the corresponding AP wired port is incorrect.
- When the RLDP loop detection configurations are modified, the **no exec-cmd** command is not executed to delete the original configurations or the **exec-cmd** command is not re-executed to cancel the configurations.

5.5 Monitoring

Displaying

| Description | Command |
|----------------------|--|
| Displays RLDP state. | show rldp [interface <i>interface-name</i>] |

6 Configuring LLDP

6.1 Overview

The Link Layer Discovery Protocol (LLDP), defined in the IEEE 802.1AB standard, is used to discover the topology and identify topological changes. LLDP encapsulates local information of a device into LLDP data units (LLDPDUs) in the type/length/value (TLV) format and then sends the LLDPDUs to neighbors. It also stores LLDPDUs from neighbors in the management information base (MIB) to be accessed by the network management system (NMS).

With LLDP, the NMS can learn about topology, for example, which ports of a device are connected to other devices and whether the rates and duplex modes at both ends of a link are consistent. Administrators can quickly locate and rectify a fault based on the information.

A Ruijie LLDP-compliant device is capable of discovering neighbors when the peer is either of the following:

- Ruijie LLDP-compliant device
- Endpoint device that complies with the Link Layer Discovery Protocol-Media Endpoint Discovery (LLDP-MED)

Protocols and Standards

- IEEE 802.1AB 2005: Station and Media Access Control Connectivity Discovery
- ANSI/TIA-1057: Link Layer Discovery Protocol for Media Endpoint Devices

6.2 Applications

| Application | Description |
|--|--|
| Displaying Topology | Multiple switches, a MED device, and an NMS are deployed in the network topology. |
| Conducting Error Detection | Two switches are directly connected and incorrect configuration will be displayed. |

6.2.1 Displaying Topology

Scenario

Multiple switches, a MED device, and an NMS are deployed in the network topology.

As shown in the following figure, the LLDP function is enabled by default and no additional configuration is required.

- Switch A and Switch B discover that they are neighbors.
- Switch A discovers its neighbor MED device, that is, IP-Phone, through port GigabitEthernet 0/1.
- The NMS accesses MIB of switch A.

Figure 6-1

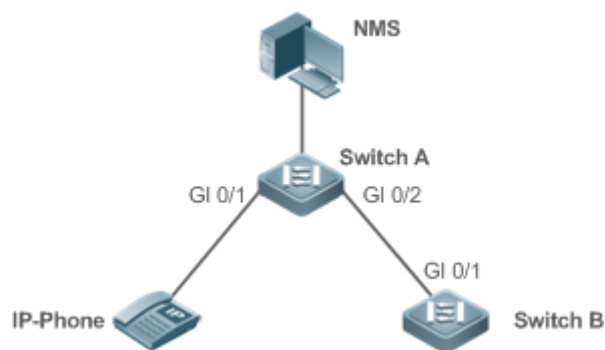

| | |
|----------------|--|
| Remarks | Ruijie Switch A, Switch B, and IP-Phone support LLDP and LLDP-MED. LLDP on switch ports works in TxRx mode. The LLDP transmission interval is 30 seconds and transmission delay is 2 seconds by default. |
|----------------|--|

Deployment

- Run LLDP on a switch to implement neighbor discovery.
- Run the Simple Network Management Protocol (SNMP) on the switch so that the NMS acquires and sets LLDP-relevant information on the switch.

6.2.2 Conducting Error Detection

Scenario

Two switches are directly connected and incorrect configuration will be displayed.

As shown in the following figure, the LLDP function and LLDP error detection function are enabled by default, and no additional configuration is required.

- After you configure a virtual local area network (VLAN), port rate and duplex mode, link aggregation, and maximum transmission unit (MTU) of a port on Switch A, an error will be prompted if the configuration does not match that on Switch B, and vice versa.

Figure 6-2



| | |
|----------------|--|
| Remarks | Ruijie Switch A and Switch B support LLDP. LLDP on switch ports works in TxRx mode. The LLDP transmission interval is 30 seconds and transmission delay is 2 seconds by default. |
|----------------|--|

Deployment

- Run LLDP on a switch to implement neighbor discovery and detect link fault.

6.3 Features

Basic Concepts

LLDPDU

LLDPDU is a protocol data unit encapsulated into an LLDP packet. Each LLDPDU is a sequence of TLV structures. The TLV collection consists of three mandatory TLVs, a series of optional TLVs, and one End of TLV. The following figure shows the format of an LLDPDU.

Figure 6-3 LLDPDU Format



In the preceding figure:

- M indicates a mandatory TLV.
- In an LLDPDU, Chassis ID TLV, Port ID TLV, Time to Live TLV, and End Of LLDPDU TLV are mandatory and TLVs of other TLVs are optional.

LLDP Encapsulation Format

LLDP packets can be encapsulated in two formats: Ethernet II and Subnetwork Access Protocols (SNAP).

The following figure shows the format of LLDP packets encapsulated in the Ethernet II format.

Figure 6-4 Ethernet II Format



In the preceding figure:

- Destination Address: Indicates the destination MAC address, which is the LLDP multicast address 01-80-C2-00-00-0E.
- Source Address: Indicates the source MAC address, which is the port MAC address.
- Ethertype: Indicates the Ethernet type, which is 0x88CC.
- LLDPDU: Indicates the LLDP protocol data unit.
- FCS: Indicates the frame check sequence.

Figure 6-5 shows the format of LLDP packets encapsulated in the SNAP format.

Figure 6-5 SNAP Format

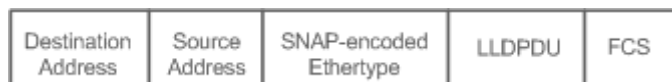

In the preceding figure:

- Destination Address: Indicates the destination MAC address, which is the LLDP multicast address 01-80-C2-00-00-0E.

- Source Address: Indicates the source MAC address, which is the port MAC address.
- SNAP-encoded Ethertype: Indicates the Ethernet type of the SNMP encapsulation, which is AA-AA-03-00-00-00-88-CC.
- LLDPDU: Indicates the LLDP protocol data unit.
- FCS: Indicates the frame check sequence.

↘ TLV

TLVs encapsulated into an LLDPDU can be classified into two types:

- Basic management TLVs
- Organizationally specific TLVs

Basic management TLVs are a collection of basic TLVs used for network management. Organizationally specific TLVs are defined by standard organizations and other institutions, for example, the IEEE 802.1 organization and IEEE 802.3 organization define their own TLV collections.

3. Basic management TLVs

The basic management TLV collection consists of two types of TLVs: mandatory TLVs and optional TLVs. A mandatory TLV must be contained in an LLDPDU for advertisement and an optional TLV is contained selectively.

The following table describes basic management TLVs.

| TLV Type | Description | Mandatory/Optional |
|-------------------------|--|--------------------|
| End Of LLDPDU TLV | Indicates the end of an LLDPDU, occupying two bytes. | Mandatory |
| Chassis ID TLV | Identifies a device with a MAC address. | Mandatory |
| Port ID TLV | Identifies a port sending LLDPDUs. | Fixed |
| Time To Live TLV | Indicates the time to live (TTL) of local information on a neighbor. When a device receives a TLV containing TTL 0, it deletes the neighbor information. | Mandatory |
| Port Description TLV | Indicates the descriptor of the port sending LLDPDUs. | Optional |
| System Name TLV | Describes the device name. | Optional |
| System Description TLV | Indicates the device description, including the hardware version, software version, and operating system information. | Optional |
| System Capabilities TLV | Describes main functions of the device, such as the bridge, routing, and relay functions. | Optional |
| Management Address TLV | Indicates the management address, which contains the interface ID and object identifier (OID). | Optional |

✔ Ruijie LLDP-compliant switches support advertisement of basic management TLVs.

4. Organizationally specific TLVs

Different organizations, such as the IEEE 802.1, IEEE 802.3, IETF and device suppliers, define specific TLVs to advertise specific information about devices. The organizationally unique identifier (OUI) field in a TLV is used to distinguish different organizations.

- Organizational specific TLVs are optional and are advertised in an LLDPDU selectively. Currently, there are three types of common organizational specific TLVs: IEEE 802.1 organizational specific TLVs, IEEE 802.3 organizational specific TLVs, and LLDP-MED TLVs.

The following table describes IEEE 802.1 organizational specific TLVs.

| TLV Type | Description |
|-------------------------------|---|
| Port VLAN ID TLV | Indicates the VLAN identifier of a port. |
| Port And Protocol VLAN ID TLV | Indicates the protocol VLAN identifier of a port. |
| VLAN Name TLV | Indicates the VLAN name of a port. |
| Protocol Identity TLV | Indicates the protocol type supported by a port. |

- ✓ Ruijie LLDP-compliant switches do not send the Protocol Identity TLV but receive this TLV.

- IEEE 802.3 organizational specific TLVs

The following table describes IEEE 802.3 organizational specific TLVs.

| TLV Type | Description |
|-----------------------------------|---|
| MAC/PHY Configuration//Status TLV | Indicates the rate and duplex mode of a port, and whether to support and enable auto-negotiation. |
| Power Via MDI TLV | Indicates the power supply capacity of a port. |
| Link Aggregation TLV | Indicates the link aggregation capacity of a port and the current aggregation state. |
| Maximum Frame Size TLV | Indicates the maximum size of the frame transmitted by a port. |

- ✓ Ruijie LLDP-compliant devices support advertisement of IEEE 802.3 organizational specific TLVs.

- LLDP-MED TLV

LLDP-MED is an extension to LLDP based on IEEE 802.1AB LLDP. It enables users to conveniently deploy the Voice Over IP (VoIP) network and detect faults. It provides applications including the network configuration policies, device discovery, PoE management, and inventory management, meeting requirements for low cost, effective management, and easy deployment.

The following table describes LLDP-MED TLVs.

| TLV Type | Description |
|-----------------------------------|--|
| LLDP-MED Capabilities TLV | Indicates the type of the LLDP-MED TLV encapsulated into an LLDPDU and device type (network connectivity device or endpoint device), and whether to support LLDP-MED,. |
| Network Policy TLV | Advertises the port VLAN configuration, supported application type (such as voice or video services), and Layer-2 priority information. |
| Location Identification TLV | Locates and identifies an endpoint device. |
| Extended Power-via-MDI TLV | Provides more advanced power supply management. |
| Inventory – Hardware Revision TLV | Indicates hardware version of a MED device. |
| Inventory – Firmware Revision TLV | Indicates the firmware version of the MED device. |

| TLV Type | Description |
|-----------------------------------|---|
| Inventory – Software Revision TLV | Indicates the software version of the MED device. |
| Inventory – Serial Number TLV | Indicates the serial number of the MED device. |
| Inventory – Manufacturer Name TLV | Indicates the name of the manufacturer of the MED device. |
| Inventory – Model Name TLV | Indicates the module name of the MED device. |
| Inventory – Asset ID TLV | Indicates the asset identifier of the MED device, used for inventory management and asset tracking. |

- ✔ Ruijie LLDP-compliant Ruijie devices support advertisement of LLDP-MED TLVs.

Overview

| Feature | Description |
|---|--|
| LLDP Work Mode | Configures the mode of transmitting and receiving LLDP packets. |
| LLDP Transmission Mechanism | Enables directly connected LLDP-compliant devices to send LLDP packets to the peer. |
| LLDP Reception Mechanism | Enables directly connected LLDP-compliant devices to receive LLDP packets from the peer. |

6.3.1 LLDP Work Mode

Configure the LLDP work mode so as to specify the LLDP packet transmission and reception mode.

Working Principle

LLDP provides three work modes:

- TxRx: Transmits and receives LLDPDUs.
- Rx Only: Only receives LLDPDUs.
- Tx Only: Only transmits LLDPDUs.

When the LLDP work mode is changed, the port initializes the protocol state machine. You can set a port initialization delay to prevent repeated initialization of a port due to frequent changes of the LLDP work mode.

Related Configuration

↘ [Configuring the LLDP Work Mode](#)

The default LLDP work mode is TxRx.

You can run the **lldp mode** command to configure the LLDP work mode.

If the work mode is set to TxRx, the device can both transmit and receive LLDP packets. If the work mode is set to Rx Only, the device can only receive LLDP packets. If the work mode is set to Tx Only, the device can only transmit LLDP packets. If the work mode is disabled, the device cannot transmit or receive LLDP packets.

6.3.2 LLDP Transmission Mechanism

LLDP packets inform peers of their neighbors. When the LLDP transmission mode is cancelled or disabled, LLDP packets cannot be transmitted to neighbors.

Working Principle

LLDP periodically transmits LLDP packets when working in TxRx or Tx Only mode. When information about the local device changes, LLDP immediately transmits LLDP packets. You can configure a delay time to avoid frequent transmission of LLDP packets caused by frequent changes of local information.

LLDP provides two types of packets:

- Standard LLDP packet, which contains management and configuration information about the local device.
- Shutdown packet: When the LLDP work mode is disabled or the port is shut down, LLDP Shutdown packets will be transmitted. A Shutdown packet consists of the Chassis ID TLV, Port ID TLV, Time To Live TLV, and End OF LLDP TLV. TTL in the Time to Live TLV is 0. When a device receives an LLDP Shutdown packet, it considers that the neighbor information is invalid and immediately deletes it.

When the LLDP work mode is changed from disabled or Rx to TxRx or Tx, or when LLDP discovers a new neighbor (that is, a device receives a new LLDP packet and the neighbor information is not stored locally), the fast transmission mechanism is started so that the neighbor quickly learns the device information. The fast transmission mechanism enables a device to transmit multiple LLDP packets at an interval of 1 second.

Related Configuration

↘ [Configuring the LLDP Work Mode](#)

The default work mode is TxRx.

Run the **lldp mode txrx** or **lldp mode tx** command to enable the LLDP packet transmission function. Run the **lldp mode rx** or **no lldp mode** command to disable the LLDP packet transmission function.

In order to enable LLDP packet reception, set the work mode to TxRx or Rx Only. If the work mode is set to Rx Only, the device can only receive LLDP packets.

↘ [Configuring the LLDP Transmission Delay](#)

The default LLDP transmission delay is 2 seconds.

Run the **lldp timer tx-delay** command to change the LLDP transmission delay.

If the delay is set to a very small value, the frequent change of local information will cause frequent transmission of LLDP packets. If the delay is set to a very large value, no LLDP packet may be transmitted even if local information is changed.

↘ [Configuring the LLDP Transmission Interval](#)

The default LLDP transmission interval is 30 seconds.

Run the **lldp timer tx-interval** command to change the LLDP transmission interval.

If the interval is set to a very small value, LLDP packets may be transmitted frequently. If the interval is set to a very large value, the peer may not discover the local device in time.

↘ [Configuring the TLVs to Be Advertised](#)

By default, an interface is allowed to advertise TLVs of all types except Location Identification TLV.

Run the **lldp tlv-enable** command to change the TLVs to be advertised.

↘ [Configuring the LLDP Fast Transmission Count](#)

By default, three LLDP packets are fast transmitted.

Run the **lldp fast-count** command to change the number of LLDP packets that are fast transmitted.

6.3.3 LLDP Reception Mechanism

A device can discover the neighbor and determine whether to age the neighbor information according to received LLDP packets.

[Working Principle](#)

A device can receive LLDP packets when working in TxRx or Rx Only mode. After receiving an LLDP packet, a device conducts validity check. After the packet passes the check, the device checks whether the packet contains information about a new neighbor or about an existing neighbor and stores the neighbor information locally. The device sets the TTL of neighbor information according to the value of TTL TLV in the packet. If the value of TTL TLV is 0, the neighbor information is aged immediately.

[Related Configuration](#)

↘ [Configuring the LLDP Work Mode](#)









The default LLDP work mode is TxRx.





Run the **lldp mode txrx** or **lldp mode rx** command to enable the LLDP packet reception function. Run the **lldp mode tx** or **no lldp mode** command to disable the LLDP packet reception function.

In order to enable LLDP packet reception, set the work mode to TxRx or Rx Only. If the work mode is set to Tx Only, the device can only transmit LLDP packets.

6.4 Configuration

| Configuration | Description and Command | |
|---|---|-----------------------------|
| Configuring the LLDP Function |  (Optional) It is used to enable or disable the LLDP function in global or interface configuration mode. | |
| | lldp enable | Enables the LLDP function. |
| | no lldp enable | Disables the LLDP function. |

| Configuration | Description and Command | |
|--|--|---|
| Configuring the LLDP Work Mode |  (Optional) It is used to configure the LLDP work mode. | |
| | lldp mode {rx tx txrx } | Configures the LLDP work mode. |
| | no lldp mode | Shuts down the LLDP work mode. |
| Configuring the TLVs to Be Advertised |  (Optional) It is used to configure the TLVs to be advertised. | |
| | lldp tlv-enable | Configures the TLVs to be advertised. |
| | no lldp tlv-enable | Cancel TLVs. |
| Configures the Management Address to Be Advertised |  (Optional) It is used to configure the management address to be advertised in LLDP packets. | |
| | lldp management-address-tlv [ip-address] | Configures the management address to be advertised in LLDP packets. |
| | no lldp management-address-tlv | Cancel the management address. |
| Configuring the LLDP Fast Transmission Count |  (Optional) It is used to configure the number of LLDP packets that are fast transmitted. | |
| | lldp fast-count value | Configures the <u>LLDP fast transmission count</u> . |
| | no lldp fast-count | Restores the default <u>LLDP fast transmission count</u> . |
| Configuring the TTL Multiplier and Transmission Interval |  (Optional) It is used to configure the TTL multiplier and transmission interval. | |
| | lldp hold-multiplier value | Configures the TTL multiplier. |
| | no lldp hold-multiplier | Restores the default TTL multiplier. |
| | lldp timer tx-interval seconds | Configures the transmission interval. |
| | no lldp timer tx-interval | Restores the default transmission interval. |
| Configuring the Transmission Delay |  (Optional) It is used to configure the delay time for LLDP packet transmission. | |
| | lldp timer tx-delay seconds | Configures the transmission delay. |
| | no lldp timer tx-delay | Restores the default transmission delay. |
| Configuring the Initialization Delay |  (Optional) It is used to configure the delay time for LLDP to initialize on any interface. | |
| | lldp timer reinit-delay seconds | Configures the initialization delay. |
| | no lldp timer reinit-delay | Restores the default initialization delay. |
| Configuring the LLDP Trap Function |  (Optional) It is used to configure the LLDP Trap function. | |
| | lldp notification remote-change enable | Enables the LLDP Trap function. |
| | no lldp notification remote-change enable | Disables the LLDP Trap function. |
| | lldp timer notification-interval | Configures the LLDP Trap transmission interval. |

| Configuration | Description and Command | |
|---|---|--|
| | no lldp timer notification-interval | Restores the default LLDP Trap transmission interval. |
| Configuring the LLDP Error Detection Function |  (Optional) It is used to configure the LLDP error detection function. | |
| | lldp error-detect | Enables the LLDP error detection function. |
| | no lldp error-detect | Disables the LLDP error detection function. |
| Configuring the LLDP Encapsulation Format |  (Optional) It is used to configure the LLDP encapsulation format. | |
| | lldp encapsulation snap | Sets the LLDP encapsulation format to SNAP. |
| | no lldp encapsulation snap | Sets the LLDP encapsulation format to Ethernet II. |
| Configuring the LLDP Network Policy |  (Optional) It is used to configure the LLDP Network Policy. | |
| | lldp network-policy profile <i>profile-num</i> | Configures an LLDP Network Policy. |
| | no lldp network-policy profile <i>profile-num</i> | Deletes an LLDP Network Policy. |
| Configuring the Civic Address |  (Optional) It is used to configure the civic address of a device. | |
| | { country state county city division neighborhood street-group leading-street-dir trailing-street-suffix street-suffix number street-number-suffix landmark additional-location-information name postal-code building unit floor room type-of-place postal-community-name post-office-box additional-code } <i>ca-word</i> | Configures the civic address of a device. |
| | no { country state county city division neighborhood street-group leading-street-dir trailing-street-suffix street-suffix number street-number-suffix landmark additional-location-information name postal-code building unit floor room type-of-place postal-community-name post-office-box additional-code } <i>ca-word</i> | Deletes civic address of a device. |
| Configuring the Emergency Telephone Number |  (Optional) It is used to configure the emergency telephone number of a device. | |
| | lldp location elin identifier <i>id</i> elin-location <i>tel-number</i> | Configures the emergency telephone number of a device. |

| Configuration | Description and Command | |
|---------------|---|---|
| | <code>no lldp location elin identifier <i>id</i></code> | Deletes the emergency telephone number of a device. |

6.4.1 Configuring the LLDP Function

Configuration Effect

- Enable or disable the LLDP function.

Notes

- To make the LLDP function take effect on an interface, you need to enable the LLDP function globally and on the interface.

Configuration Steps

- Optional.
- Configure the LLDP function in global or interface configuration mode.

Verification

Display LLDP status

- Check whether the LLDP function is enabled in global configuration mode.
- Check whether the LLDP function is enabled in interface configuration mode.

Related Commands

▾ Enabling the LLDP Function

| | |
|------------------------------|--|
| Command | <code>lldp enable</code> |
| Parameter Description | N/A |
| Command Mode | Global configuration mode/Interface configuration mode |
| Usage Guide | The LLDP function takes effect on an interface only after it is enabled in global configuration mode and interface configuration mode. |

▾ Disabling the LLDP Function

| | |
|------------------------------|--|
| Command | <code>no lldp enable</code> |
| Parameter Description | N/A |
| Command Mode | Global configuration mode/Interface configuration mode |
| Usage Guide | N/A |

Configuration Example

▾ Disabling the LLDP Function

| | |
|----------------------------|--|
| Configuration Steps | Disable the LLDP function in global configuration mode. |
| | <pre>Ruijie(config)#no lldp enable</pre> |
| Verification | Display global LLDP status. |
| | <pre>Ruijie(config)#show lldp status</pre> Global status of LLDP: Disable |

Common Errors

- If the LLDP function is enabled on an interface but disabled in global configuration mode, the LLDP function does not take effect on the interface.
- A port can learn a maximum of five neighbors.
- If a neighbor does not support LLDP but it is connected to an LLDP-supported device, a port may learn information about the device that is not directly connected to the port because the neighbor may forward LLDP packets.

6.4.2 Configuring the LLDP Work Mode

Configuration Effect

- If you set the LLDP work mode to TxRx, the interface can transmit and receive packets.
- If you set the LLDP work mode to Tx, the interface can only transmit packets but cannot receive packets.
- If you set the LLDP work mode to Rx, the interface can only receive packets but cannot transmit packets.
- If you disable the LLDP work mode, the interface can neither receive nor transmit packets.

Notes

- LLDP runs on physical ports (AP member ports for AP ports). Stacked ports and VSL ports do not support LLDP.

Configuration Steps

- Optional.
- Set the LLDP work mode to Tx or Rx as required.

Verification

Display LLDP status information on an interface

- Check whether the configuration takes effect.

Related Commands

▾ Configuring the LLDP Work Mode

| | |
|---------------------|--|
| Command | <code>lldp mode { rx tx txrx }</code> |
| Parameter | <code>rx</code> : Only receives LLDPDUs. |
| Description | <code>tx</code> : Only transmits LLDPDUs. <code>txrx</code> : Transmits and receives LLDPDUs. |
| Command Mode | Interface configuration mode |
| Usage Guide | To make LLDP take effect on an interface, make sure to enable LLDP globally and set the LLDP work mode on the interface to Tx, Rx or TxRx. |

▾ Disabling the LLDP Work Mode

| | |
|---------------------|--|
| Command | <code>no lldp mode</code> |
| Parameter | N/A |
| Description | |
| Command Mode | Interface configuration mode |
| Usage Guide | After the LLDP work mode on an interface is disabled, the interface does not transmit or receive LLDP packets. |

Configuration Example

▾ Configuring the LLDP Work Mode

| | |
|----------------------------|--|
| Configuration Steps | Set the LLDP work mode to Tx in interface configuration mode. |
| | <pre>Ruijie(config)#interface gigabitethernet 0/1 Ruijie(config-if-GigabitEthernet 0/1)#lldp mode tx</pre> |
| Verification | Display LLDP status information on the interface. |
| | <pre>Ruijie(config-if-GigabitEthernet 0/1)#show lldp status interface gigabitethernet 0/1 Port [GigabitEthernet 0/1] Port status of LLDP : Enable Port state : UP Port encapsulation : Ethernet II Operational mode : TxOnly Notification enable : NO</pre> |

| | |
|-------------------------|-------|
| Error detect enable | : YES |
| Number of neighbors | : 0 |
| Number of MED neighbors | : 0 |

6.4.3 Configuring the TLVs to Be Advertised

Configuration Effect

- Configure the type of TLVs to be advertised to specify the LLDPDUs in LLDP packets.

Notes

- If you configure the **all** parameter for the basic management TLVs, IEEE 802.1 organizationally specific TLVs, and IEEE 802.3 organizationally specific TLVs, all optional TLVs of these types are advertised.
- If you configure the **all** parameter for the LLDP-MED TLVs, all LLDP-MED TLVs except Location Identification TLV are advertised.
- If you want to configure the LLDP-MED Capability TLV, configure the LLDP 802.3 MAC/PHY TLV first; If you want to cancel the LLDP 802.3 MAC/PHY TLV, cancel the LLDP-MED Capability TLV first.
- If you want to configure LLDP-MED TLVs, configure the LLDP-MED Capability TLV before configuring other types of LLDP-MED TLVs. If you want to cancel LLDP-MED TLVs, cancel the LLDP-MED Capability TLV before canceling other types of LLDP-MED TLVs. If a device is connected to an IP-Phone that supports LLDP-MED, you can configure the Network Policy TLV to push policy configuration to the IP-Phone.
- If a device supports the DCBX function by default, ports of the device are not allowed to advertise IEEE 802.3 organizationally specific TLVs and LLDP-MED TLVs by default.

Configuration Steps

- Optional.
- Configure the type of TLVs to be advertised on an interface.

Verification

Display the configuration of TLVs to be advertised on an interface

- Check whether the configuration takes effect.

Related Commands

↘ Configuring TLVs to Be Advertised

| | |
|---------|--|
| Command | <code>lldp tlv-enable { basic-tlv { all port-description system-capability system-description system-name } dot1-tlv { all port-vlan-id protocol-vlan-id [vlan-id] vlan-name [vlan-id] } dot3-tlv { all link-aggregation mac-physic max-frame-size power } med-tlv { all capability inventory location { civic-location elin } identifier id network-policy profile [profile-num] }</code> |
|---------|--|

| | |
|------------------------------|--|
| | power-over-ethernet } } |
| Parameter Description | <p>basic-tlv: Indicates the basic management TLV.</p> <p>port-description: Indicates the Port Description TLV.</p> <p>system-capability: Indicates the System Capabilities TLV.</p> <p>system-description: Indicates the System Description TLV.</p> <p>system-name: Indicates the System Name TLV.</p> <p>dot1-tlv: Indicates the IEEE 802.1 organizationally specific TLVs.</p> <p>port-vlan-id: Indicates the Port VLAN ID TLV.</p> <p>protocol-vlan-id: Indicates the Port And Protocol VLAN ID TLV.</p> <p><i>vlan-id:</i> Indicates the Port Protocol VLAN ID, ranging from 1 to 4,094.</p> <p>vlan-name: Indicates the VLAN Name TLV.</p> <p><i>vlan-id:</i> Indicates the VLAN name, ranging from 1 to 4,094.</p> <p>dot3-tlv: Indicates the IEEE 802.3 organizationally specific TLVs.</p> <p>link-aggregation: Indicates the Link Aggregation TLV.</p> <p>mac-physic: Indicates the MAC/PHY Configuration/Status TLV.</p> <p>max-frame-size: Indicates the Maximum Frame Size TLV.</p> <p>power: Indicates the Power Via MDI TLV.</p> <p>med-tlv: Indicates the LLDP MED TLV.</p> <p>capability: Indicates the LLDP-MED Capabilities TLV.</p> <p>Inventory: Indicates the inventory management TLV, which contains the hardware version, firmware version, software version, SN, manufacturer name, module name, and asset identifier.</p> <p>location: Indicates the Location Identification TLV.</p> <p>civic-location: Indicates the civic address information and postal information.</p> <p>elin: Indicates the emergency telephone number.</p> <p><i>id:</i> Indicates the policy ID, ranging from 1 to 1,024.</p> <p>network-policy: Indicates the Network Policy TLV.</p> <p><i>profile-num:</i> Indicates the Network Policy ID, ranging from 1 to 1,024.</p> <p>power-over-ethernet: Indicates the Extended Power-via-MDI TLV.</p> |
| Command Mode | Interface configuration mode |
| Usage Guide | N/A |

 **Canceling TLVs**

| | |
|------------------------------|--|
| Command | <pre>no lldp tlv-enable {basic-tlv { all port-description system-capability system-description system-name } dot1-tlv { all port-vlan-id protocol-vlan-id vlan-name } dot3-tlv { all link-aggregation mac-physic max-frame-size power } med-tlv { all capability inventory location { civic-location elin } identifier id network-policy profile [profile-num] power-over-ethernet } }</pre> |
| Parameter Description | <p>basic-tlv: Indicates the basic management TLV.</p> <p>port-description: Indicates the Port Description TLV.</p> <p>system-capability: Indicates the System Capabilities TLV.</p> |

| | |
|---------------------|---|
| | <p>system-description: Indicates the System Description TLV.</p> <p>system-name: Indicates the System Name TLV.</p> <p>dot1-tlv: Indicates the IEEE 802.1 organizationally specific TLVs.</p> <p>port-vlan-id: Indicates the Port VLAN ID TLV.</p> <p>protocol-vlan-id: Indicates the Port And Protocol VLAN ID TLV.</p> <p>vlan-name: Indicates the VLAN Name TLV.</p> <p>dot3-tlv: Indicates the IEEE 802.3 organizationally specific TLVs.</p> <p>link-aggregation: Indicates the Link Aggregation TLV.</p> <p>mac-physic: Indicates the MAC/PHY Configuration/Status TLV.</p> <p>max-frame-size: Indicates the Maximum Frame Size TLV.</p> <p>power: Indicates the Power Via MDI TLV.</p> <p>med-tlv: Indicates the LLDP MED TLV.</p> <p>capability: Indicates the LLDP-MED Capabilities TLV.</p> <p>Inventory: Indicates the inventory management TLV, which contains the hardware version, firmware version, software version, SN, manufacturer name, module name, and asset identifier.</p> <p>location: Indicates the Location Identification TLV.</p> <p>civic-location: Indicates the civic address information and postal information.</p> <p>elin: Indicates the emergency telephone number.</p> <p><i>id:</i> Indicates the policy ID, ranging from 1 to 1,024.</p> <p>network-policy: Indicates the Network Policy TLV.</p> <p><i>profile-num:</i> Indicates the Network Policy ID, ranging from 1 to 1,024.</p> <p>power-over-ethernet: Indicates the Extended Power-via-MDI TLV.</p> |
| Command Mode | Interface configuration mode |
| Usage Guide | N/A |

Configuration Example

Configuring TLVs to Be Advertised

| | |
|----------------------------|---|
| Configuration Steps | Cancel the advertisement of the IEEE 802.1 organizationally specific Port And Protocol VLAN ID TLV. |
| | <pre>Ruijie(config)#interface gigabitethernet 0/1 Ruijie(config-if-GigabitEthernet 0/1)#no lldp tlv-enable dot1-tlv protocol-vlan-id</pre> |
| Verification | Display LLDP TLV configuration in interface configuration mode. |
| | <pre>Ruijie(config-if-GigabitEthernet 0/1)#show lldp tlv-config interface gigabitethernet 0/1 LLDP tlv-config of port [GigabitEthernet 0/1] NAME STATUS DEFAULT ----- -----</pre> |

| | | |
|-------------------------------|-----|-----|
| Basic optional TLV: | | |
| Port Description TLV | YES | YES |
| System Name TLV | YES | YES |
| System Description TLV | YES | YES |
| System Capabilities TLV | YES | YES |
| Management Address TLV | YES | YES |
| IEEE 802.1 extend TLV: | | |
| Port VLAN ID TLV | YES | YES |
| Port And Protocol VLAN ID TLV | NO | YES |
| VLAN Name TLV | YES | YES |
| IEEE 802.3 extend TLV: | | |
| MAC-Physic TLV | YES | YES |
| Power via MDI TLV | YES | YES |
| Link Aggregation TLV | YES | YES |
| Maximum Frame Size TLV | YES | YES |
| LLDP-MED extend TLV: | | |
| Capabilities TLV | YES | YES |
| Network Policy TLV | YES | YES |
| Location Identification TLV | NO | NO |
| Extended Power via MDI TLV | YES | YES |
| Inventory TLV | YES | YES |

6.4.4 Configures the Management Address to Be Advertised

Configuration Effect

- Configure the management address to be advertised in LLDP packets in interface configuration mode.
- After the management address to be advertised is cancelled, the management address in LLDP packets is subject to the default settings.

Notes

- LLDP runs on physical ports (AP member ports for AP ports). Stacked ports and VSL ports do not support LLDP.

Configuration Steps

- Optional.
- Configure the management address to be advertised in LLDP packets in interface configuration mode.

Verification

Display LLDP information on a local interface

- Check whether the configuration takes effect.

Related Commands

▾ Configuring the Management Address to Be Advertised

| | |
|------------------------------|---|
| Command | lldp management-address-tlv [<i>ip-address</i>] |
| Parameter Description | <i>ip-address</i> : Indicates the management address to be advertised in an LLDP packet. |
| Command Mode | Interface configuration mode |
| Usage Guide | A management address is advertised through LLDP packets by default. The management address is the IPv4 address of the minimum VLAN supported by the port. If no IPv4 address is configured for the VLAN, LLDP keeps searching for the qualified IP address. If no IPv4 address is found, LLDP searches for the IPv6 address of the minimum VLAN supported by the port. If no IPv6 address is found, the loopback address 127.0.0.1 is used as the management address. |

▾ Canceling the Management Address

| | |
|------------------------------|---|
| Command | no lldp management-address-tlv |
| Parameter Description | N/A |
| Command Mode | Interface configuration mode |
| Usage Guide | A management address is advertised through LLDP packets by default. The management address is the IPv4 address of the minimum VLAN supported by the port. If no IPv4 address is configured for the VLAN, LLDP keeps searching for the qualified IP address. If no IPv4 address is found, LLDP searches for the IPv6 address of the minimum VLAN supported by the port. If no IPv6 address is found, the loopback address 127.0.0.1 is used as the management address. |

Configuration Example

▾ Configuring the Management Address to Be Advertised

| | |
|----------------------|--|
| Configuration | Set the management address to 192.168.1.1 on an interface. |
|----------------------|--|

| | |
|---------------------|---|
| Steps | |
| | <pre>Ruijie(config)#interface gigabitethernet 0/1 Ruijie(config-if-GigabitEthernet 0/1)#lldp management-address-tlv 192.168.1.1</pre> |
| | |
| Verification | <p>Display configuration on the interface.</p> |
| | <pre>Ruijie(config-if-GigabitEthernet 0/1)#show lldp local-information interface GigabitEthernet 0/1 Lldp local-information of port [GigabitEthernet 0/1] Port ID type : Interface name Port id : GigabitEthernet 0/1 Port description : GigabitEthernet 0/1 Management address subtype : ipv4 Management address : 192.168.1.1 Interface numbering subtype : ifIndex Interface number : 1 Object identifier : 802.1 organizationally information Port VLAN ID : 1 Port and protocol VLAN ID (PPVID) : 1 PPVID Supported : YES PPVID Enabled : NO VLAN name of VLAN 1 : VLAN0001 Protocol Identity : 802.3 organizationally information Auto-negotiation supported : YES Auto-negotiation enabled : YES PMD auto-negotiation advertised : 100BASE-T full duplex mode, 100BASE-TX full duplex mode, 100BASE-TX half duplex mode, 10BASE-T full duplex mode, 10BASE-T half duplex mode Operational MAU type : speed(100)/duplex(Full) PoE support : NO</pre> |

| | |
|---------------------------------------|--------------|
| Link aggregation supported | : YES |
| Link aggregation enabled | : NO |
| Aggregation port ID | : 0 |
| Maximum frame Size | : 1500 |
| LLDP-MED organizationally information | |
| Power-via-MDI device type | : PD |
| Power-via-MDI power source | : Local |
| Power-via-MDI power priority | : |
| Power-via-MDI power value | : |
| Model name | : Model name |

6.4.5 Configuring the LLDP Fast Transmission Count

Configuration Effect

- Configure the number of LLDP packets that are fast transmitted.

Configuration Steps

- Optional.
- Configure the number of LLDP packets that are fast transmitted in global configuration mode.

Verification

Displaying the global LLDP status information

- Check whether the configuration takes effect.

Related Commands

↘ Configuring the LLDP Fast Transmission Count

| | |
|------------------------------|---|
| Command | lldp fast-count <i>value</i> |
| Parameter Description | <i>value</i> : Indicates the number of LLDP packets that are fast transmitted. The value ranges from 1 to 10. The default value is 3. |
| Command Mode | Global configuration mode |
| Usage Guide | N/A |

↘ Restoring the Default LLDP Fast Transmission Count

| | |
|----------------|---------------------------|
| Command | no lldp fast-count |
|----------------|---------------------------|

| | |
|------------------------------|---------------------------|
| Parameter Description | N/A |
| Command Mode | Global configuration mode |
| Usage Guide | N/A |

Configuration Example

Configuring the LLDP Fast Transmission Count

| | |
|----------------------------|--|
| Configuration Steps | Set the LLDP fast transmission count to 5 in global configuration mode. |
| | <pre>Ruijie(config)#lldp fast-count 5</pre> |
| Verification | Display the global LLDP status information. |
| | <pre>Ruijie(config)#show lldp status Global status of LLDP : Enable Neighbor information last changed time : Transmit interval : 30s Hold multiplier : 4 Reinit delay : 2s Transmit delay : 2s Notification interval : 5s Fast start counts : 5</pre> |

6.4.6 Configuring the TTL Multiplier and Transmission Interval

Configuration Effect

- Configure the TTL multiplier.
- Configure the LLDP packet transmission interval.

Configuration Steps

- Optional.
- Perform the configuration in global configuration mode.

Verification

Display LLDP status information on an interface

- Check whether the configuration takes effect.

Related Commands

Configuring the TTL Multiplier

| | |
|------------------------------|--|
| Command | lldp hold-multiplier <i>value</i> |
| Parameter Description | <i>value</i> : Indicates the TTL multiplier. The value ranges from 2 to 10. The default value is 4. |
| Command Mode | Global configuration mode |
| Usage Guide | In an LLDP packet, the value of Time To Live TLV is calculated based on the following formula: Time to Live TLV = TTL multiplier x Packet transmission interval + 1. Therefore, you can modify the Time to Live TLV in LLDP packets by configuring the TTL multiplier. |

Restoring the Default TTL Multiplier

| | |
|------------------------------|--|
| Command | no lldp hold-multiplier |
| Parameter Description | N/A |
| Command Mode | Global configuration mode |
| Usage Guide | In an LLDP packet, the value of Time To Live TLV is calculated based on the following formula: Time to Live TLV = TTL multiplier x Packet transmission interval + 1. Therefore, you can modify the Time to Live TLV in LLDP packets by configuring the TTL multiplier. |

Configuring the Transmission Interval

| | |
|------------------------------|--|
| Command | lldp timer tx-interval <i>seconds</i> |
| Parameter Description | <i>seconds</i> : Indicates the LLDP packet transmission interval. The value ranges from 5 to 32,768. |
| Command Mode | Global configuration mode |
| Usage Guide | N/A |

Restoring the Default Transmission Interval

| | |
|------------------------------|----------------------------------|
| Command | no lldp timer tx-interval |
| Parameter Description | N/A |
| Command Mode | Global configuration mode |
| Usage Guide | N/A |

Configuration Example

Configuring the TTL Multiplier and Transmission Interval

| | |
|----------------------------|--|
| Configuration Steps | Set the TTL multiplier to 3 and the transmission interval to 20 seconds. The TTL of local device information on neighbors is 61 seconds. |
| | <pre>Ruijie(config)#lldp hold-multiplier 3 Ruijie(config)#lldp timer tx-interval 20</pre> |
| Verification | Display the global LLDP status information. |
| | <pre>Ruijie(config)#lldp hold-multiplier 3 Ruijie(config)#lldp timer tx-interval 20 Ruijie(config)#show lldp status Global status of LLDP : Enable Neighbor information last changed time : Transmit interval : 20s Hold multiplier : 3 Reinit delay : 2s Transmit delay : 2s Notification interval : 5s Fast start counts : 3</pre> |

6.4.7 Configuring the Transmission Delay

Configuration Effect

- Configure the delay time for LLDP packet transmission.

Configuration Steps

- Optional.
- Perform the configuration in global configuration mode.

Verification

Displaying the global LLDP status information

- Check whether the configuration takes effect.

Related Commands

↘ Configuring the Transmission Delay

| | |
|------------------|--|
| Command | lldp timer tx-delay <i>seconds</i> |
| Parameter | <i>seconds</i> : Indicates the transmission delay. The value ranges from 1 to 8,192. |

| | |
|---------------------|--|
| Description | |
| Command Mode | Global configuration mode |
| Usage Guide | When local information of a device changes, the device immediately transmits LLDP packets to its neighbors. Configure the transmission delay to prevent frequent transmission of LLDP packets caused by frequent changes of local information. |

↘ Restoring the Default Transmission Delay

| | |
|------------------------------|--|
| Command | no lldp timer tx-delay |
| Parameter Description | N/A |
| Command Mode | Global configuration mode |
| Usage Guide | When local information of a device changes, the device immediately transmits LLDP packets to its neighbors. Configure the transmission delay to prevent frequent transmission of LLDP packets caused by frequent changes of local information. |

Configuration Example

↘ Configuring the Transmission Delay

| | |
|----------------------------|--|
| Configuration Steps | Set the transmission delay to 3 seconds. |
| | <pre>Ruijie(config)#lldp timer tx-delay 3</pre> |
| Verification | Display the global LLDP status information. |
| | <pre>Ruijie(config)#show lldp status Global status of LLDP : Enable Neighbor information last changed time : Transmit interval : 30s Hold multiplier : 4 Reinit delay : 2s Transmit delay : 3s Notification interval : 5s Fast start counts : 3</pre> |

6.4.8 Configuring the Initialization Delay

Configuration Effect

- Configure the delay time for LLDP to initialize on any interface.

Configuration Steps

- Optional.
- Configure the delay time for LLDP to initialize on any interface.

Verification

Display the global LLDP status information

- Check whether the configuration takes effect.

Related Commands

▾ Configuring the Initialization Delay

| | |
|------------------------------|--|
| Command | lldp timer reinit-delay <i>seconds</i> |
| Parameter Description | <i>seconds</i> : Indicates the initialization delay . The value ranges from 1 to 10 seconds. |
| Command Mode | Global configuration mode |
| Usage Guide | Configure the initialization delay to prevent frequent initialization of the state machine caused by frequent changes of the port work mode. |

▾ Restoring the Default Initialization Delay

| | |
|------------------------------|--|
| Command | no lldp timer reinit-delay |
| Parameter Description | N/A |
| Command Mode | Global configuration mode |
| Usage Guide | Configure the initialization delay to prevent frequent initialization of the state machine caused by frequent changes of the port work mode. |

Configuration Example

▾ Configuring the Initialization Delay

| | |
|----------------------------|---|
| Configuration Steps | Set the initialization delay to 3 seconds. |
| | <pre>Ruijie(config)#lldp timer reinit-delay 3</pre> |
| Verification | Display the global LLDP status information. |
| | <pre>Ruijie(config)#show lldp status</pre> |

| | |
|--|----------|
| Global status of LLDP | : Enable |
| Neighbor information last changed time | : |
| Transmit interval | : 30s |
| Hold multiplier | : 4 |
| Reinit delay | : 3s |
| Transmit delay | : 2s |
| Notification interval | : 5s |
| Fast start counts | : 3 |

6.4.9 Configuring the LLDP Trap Function

Configuration Effect

- Configure the interval for transmitting LLDP Trap messages.

Configuration Steps

▾ Enabling the LLDP Trap Function

- Optional.
- Perform the configuration in interface configuration mode.

▾ Configuring the LLDP Trap Transmission Interval

- Optional.
- Perform the configuration in global configuration mode.

Verification

Display LLDP status information

- Check whether the LLDP Trap function is enabled.
- Check whether the interval configuration takes effect.

Related Commands

▾ Enabling the LLDP Trap Function

| | |
|---------------------|--|
| Command | lldp notification remote-change enable |
| Parameter | N/A |
| Description | |
| Command Mode | Interface configuration mode |
| Usage Guide | The LLDP Trap function enables a device to send its local LLDP information (such as neighbor discovery |

| | |
|--|--|
| | and communication link fault) to the NMS server so that administrators learn about the network performance |
|--|--|

▾ Disabling the LLDP Trap Function

| | |
|------------------------------|--|
| Command | no lldp notification remote-change enable |
| Parameter Description | N/A |
| Command Mode | Interface configuration mode |
| Usage Guide | The LLDP Trap function enables a device to send its local LLDP information (such as neighbor discovery and communication link fault) to the NMS server so that administrators learn about the network performance. |

▾ Configuring the LLDP Trap Transmission Interval

| | |
|------------------------------|---|
| Command | lldp timer notification-interval <i>seconds</i> |
| Parameter Description | <i>seconds</i> : Indicates the interval for transmitting LLDP Trap messages. The value ranges from 5 to 3,600 seconds. The default value is 5 seconds. |
| Command Mode | Global configuration mode |
| Usage Guide | Configure the LLDP Trap transmission interval to prevent frequent transmission of LLDP Trap messages. LLDP changes detected within this interval will be transmitted to the NMS server. |

▾ Restoring the LLDP Trap Transmission Interval

| | |
|------------------------------|---|
| Command | no lldp timer notification-interval |
| Parameter Description | N/A |
| Command Mode | Global configuration mode |
| Usage Guide | Configure the LLDP Trap transmission interval to prevent frequent transmission of LLDP Trap messages. LLDP changes detected within this interval will be transmitted to the NMS server. |

Configuration Example

▾ Enabling the LLDP Trap Function and Configuring the LLDP Trap Transmission Interval

| | |
|----------------------------|---|
| Configuration Steps | Enable the LLDP Trap function and set the LLDP Trap transmission interval to 10 seconds. |
| | <pre>Ruijie(config)#lldp timer notification-interval 10 Ruijie(config)#interface gigabitethernet 0/1 Ruijie(config-if-GigabitEthernet 0/1)#lldp notification remote-change enable</pre> |
| Verification | Display LLDP status information. |

```
Ruijie(config-if-GigabitEthernet 0/1)#show lldp status

Global status of LLDP           : Enable
Neighbor information last changed time :
Transmit interval               : 30s
Hold multiplier                 : 4
Reinit delay                   : 2s
Transmit delay                  : 2s
Notification interval          : 10s
Fast start counts              : 3

-----

Port [GigabitEthernet 0/1]

-----

Port status of LLDP           : Enable
Port state                    : UP
Port encapsulation            : Ethernet II
Operational mode              : RxAndTx
Notification enable           : YES
Error detect enable           : YES
Number of neighbors           : 0
Number of MED neighbors       : 0
```

6.4.10 Configuring the LLDP Error Detection Function

Configuration Effect

- Enable the LLDP error detection function. When LLDP detects an error, the error is logged.
- Configure the LLDP error detection function to detect VLAN configuration at both ends of a link, port status, aggregate port configuration, MTU configuration, and loops.

Notes

N/A

Configuration Steps

- Optional.
- Enable or disable the LLDP error detection function in interface configuration mode.

Verification

Display LLDP status information on an interface

- Check whether the configuration takes effect.

Related Commands

▾ Enabling the LLDP Error Detection Function

| | |
|------------------------------|--|
| Command | lldp error-detect |
| Parameter Description | N/A |
| Command Mode | Interface configuration mode |
| Usage Guide | The LLDP error detection function relies on specific TLVs in LLDP packets exchanged between devices at both ends of a link. Therefore, a device needs to advertise correct TLVs to ensure the LLDP error detection function. |

▾ Disabling the LLDP Error Detection Function

| | |
|------------------------------|--|
| Command | no lldp error-detect |
| Parameter Description | N/A |
| Command Mode | Interface configuration mode |
| Usage Guide | The LLDP error detection function relies on specific TLVs in LLDP packets exchanged between devices at both ends of a link. Therefore, a device needs to advertise correct TLVs to ensure the LLDP error detection function. |

Configuration Example

▾ Enabling the LLDP Error Detection Function

| | |
|----------------------------|---|
| Configuration Steps | Enable the LLDP error detection function on interface GigabitEthernet 0/1. |
| | <pre>Ruijie(config)#interface gigabitethernet 0/1 Ruijie(config-if-GigabitEthernet 0/1)#lldp error-detect</pre> |
| Verification | Display LLDP status information on the interface. |
| | <pre>Ruijie(config-if-GigabitEthernet 0/1)#show lldp status interface gigabitethernet 0/1 Port [GigabitEthernet 0/1] Port status of LLDP : Enable</pre> |

| | |
|-------------------------|---------------|
| Port state | : UP |
| Port encapsulation | : Ethernet II |
| Operational mode | : RxAndTx |
| Notification enable | : NO |
| Error detect enable | : YES |
| Number of neighbors | : 0 |
| Number of MED neighbors | : 0 |

6.4.11 Configuring the LLDP Encapsulation Format

Configuration Effect

- Configure the LLDP encapsulation format.

Configuration Steps

- Optional.
- Configure the LLDP encapsulation format on an interface.

Verification

Display LLDP status information of an interface

- Check whether the configuration takes effect.

Related Commands

⌵ Setting the LLDP Encapsulation Format to SNAP

| | |
|------------------------------|---|
| Command | lldp encapsulation snap |
| Parameter Description | N/A |
| Command Mode | Interface configuration mode |
| Usage Guide |  The LLDP encapsulation format configuration on a device and its neighbors must be consistent. |

⌵ Restoring the Default LLDP Encapsulation Format (Ethernet II)

| | |
|------------------------------|-----------------------------------|
| Command | No lldp encapsulation snap |
| Parameter Description | N/A |
| Command Mode | Interface configuration mode |

| | |
|--------------------|---|
| Usage Guide |  The LLDP encapsulation format configuration on a device and its neighbors must be consistent. |
|--------------------|---|

Configuration Example

Setting the LLDP Encapsulation Format to SNAP

| | |
|----------------------------|---|
| Configuration Steps | Set the LLDP encapsulation format to SNAP. |
| | <pre>Ruijie(config)#interface gigabitethernet 0/1 Ruijie(config-if-GigabitEthernet 0/1)#lldp encapsulation snap</pre> |
| Verification | Display LLDP status information on the interface. |
| | <pre>Ruijie(config-if-GigabitEthernet 0/1)#show lldp status interface gigabitethernet 0/1 Port [GigabitEthernet 0/1] Port status of LLDP : Enable Port state : UP Port encapsulation : Snap Operational mode : RxAndTx Notification enable : NO Error detect enable : YES Number of neighbors : 0 Number of MED neighbors : 0</pre> |

6.4.12 Configuring the LLDP Network Policy

Configuration Effect

- Configure the LLDP Network Policy.
- If a device is connected to an IP-Phone that supports LLDP-MED, you can configure the Network Policy TLV to push policy configuration to the IP-Phone, which enables the IP-Phone to change the tag and QoS of voice streams. In addition to the LLDP Network Policy, perform the following steps on the device: 1. Enable the Voice VLAN function and add the port connected to the IP-Phone to the Voice VLAN. 2. Configure the port connected to the IP-Phone as a QoS trusted port (the trusted DSCP mode is recommended). 3. If 802.1X authentication is also enabled on the port, configure a secure channel for the packets from the Voice VLAN. If the IP-Phone does not support LLDP-MED, enable the voice VLAN function and add the MAC address of the IP-Phone to the Voice VLAN OUI list manually.
- For the configuration of the QoS trust mode, see *Configuring IP QoS*; for the configuration of the Voice VLAN, see *Configuring Voice VLAN*; for the configuration of the secure channel, see *Configuring ACL*.

Configuration Steps

- Optional.
- Configure the LLDP Network Policy.

Verification

Displaying the LLDP network policy configuration.

- Check whether the configuration takes effect.

Related Commands

▾ Configuring the LLDP Network Policy

| | |
|------------------------------|---|
| Command | lldp network-policy profile <i>profile-num</i> |
| Parameter Description | <i>profile-num</i> : Indicates the ID of an LLDP Network Policy. The value ranges from 1 to 1,024. |
| Command Mode | Global configuration mode |
| Usage Guide | Run this command to enter the LLDP network policy mode after specifying a policy ID. After entering the LLDP network policy mode, run the { voice voice-signaling } vlan command to configure a specific network policy. |

▾ Deleting the LLDP Network Policy

| | |
|------------------------------|---|
| Command | no lldp network-policy profile <i>profile-num</i> |
| Parameter Description | <i>profile-num</i> : Indicates the LLDP Network Policy ID. The value ranges from 1 to 1,024. |
| Command Mode | Interface configuration mode |
| Usage Guide | Run this command to enter the LLDP network policy mode after specifying a policy ID. After entering the LLDP network policy mode, run the { voice voice-signaling } vlan command to configure a specific network policy. |

Configuration Example

▾ Configuring the LLDP Network Policy

| | |
|----------------------------|--|
| Configuration Steps | Set the Network Policy TLV to 1 for LLDP packets to be advertised by port GigabitEthernet 0/1 and set the VLAN ID of the Voice application to 3, COS to 4, and DSCP to 6. |
| | <pre>Ruijie#config Ruijie(config)#lldp network-policy profile 1 Ruijie(config-lldp-network-policy)# voice vlan 3 cos 4 Ruijie(config-lldp-network-policy)# voice vlan 3 dscp 6</pre> |

| | |
|---------------------|--|
| | <pre>Ruijie(config-lldp-network-policy)#exit Ruijie(config)# interface gigabitethernet 0/1 Ruijie(config-if-GigabitEthernet 0/1)# lldp tlv-enable med-tlv network-policy profile 1</pre> |
| Verification | Display the LLDP network policy configuration on the local device. |
| | <pre>network-policy information: ----- network policy profile :1 voice vlan 3 cos 4 voice vlan 3 dscp 6</pre> |

6.4.13 Configuring the Civic Address

Configuration Effect

- Configure the civic address of a device.

Configuration Steps

- Optional.
- Perform this configuration in LLDP Civic Address configuration mode.

Verification

Display the LLDP civic address of the local device

- Check whether the configuration takes effect.

Related Commands

▾ Configuring the Civic Address of a Device

| | |
|------------------------------|--|
| Command | <p>Configure the LLDP civic address. Use the no option to delete the address.</p> <pre>{ country state county city division neighborhood street-group leading-street-dir trailing-street-suffix street-suffix number street-number-suffix landmark additional-location-information name postal-code building unit floor room type-of-place postal-community-name post-office-box additional-code } <i>ca-word</i></pre> |
| Parameter Description | <p>country: Indicates the country code, with two characters. CH indicates China.</p> <p>state: Indicates the CA type is 1.</p> <p>county: Indicates that the CA type is 2.</p> <p>city: Indicates that the CA type is 3.</p> <p>division: Indicates that the CA type is 4.</p> <p>neighborhood: Indicates that the CA type is 5.</p> |

| | |
|---------------------|--|
| | <p>street-group: Indicates that the CA type is 6.</p> <p>leading-street-dir: Indicates that the CA type is 16.</p> <p>trailing-street-suffix: Indicates that the CA type is 17.</p> <p>street-suffix: Indicates that the CA type is 18.</p> <p>number: Indicates that the CA type is 19.</p> <p>street-number-suffix: Indicates that the CA type is 20.</p> <p>landmark: Indicates that the CA type is 21.</p> <p>additional-location-information: Indicates that the CA type is 22.</p> <p>name: Indicates that the CA type is 23.</p> <p>postal-code: Indicates that the CA type is 24.</p> <p>building: Indicates that the CA type is 25.</p> <p>unit: Indicates that the CA type is 26.</p> <p>floor: Indicates that the CA type is 27.</p> <p>room: Indicates that the CA type is 28.</p> <p>type-of-place: Indicates that the CA type is 29.</p> <p>postal-community-name: Indicates that the CA type is 30.</p> <p>post-office-box: Indicates that the CA type is 31.</p> <p>additional-code: Indicates that the CA type is 32.</p> <p><i>ca-word</i>: Indicates the address.</p> |
| Command Mode | LLDP Civic Address configuration mode |
| Usage Guide | After entering the LLDP Civic Address configuration mode, configure the LLDP civic address. |

↘ **Deleting the Civic Address of a Device**

| | |
|------------------------------|---|
| Command | no { country state county city division neighborhood street-group leading-street-dir trailing-street-suffix street-suffix number street-number-suffix landmark additional-location-information name postal-code building unit floor room type-of-place postal-community-name post-office-box additional-code } |
| Parameter Description | N/A |
| Command Mode | LLDP Civic Address configuration mode |
| Usage Guide | After entering the LLDP Civic Address configuration mode, configure the LLDP civic address. |

↘ **Configuring the Device Type**

| | |
|------------------------------|--|
| Command | device-type <i>device-type</i> |
| Parameter Description | <p><i>device-type</i>: Indicates the device type. The value ranges from 0 to 2. The default value is 1.</p> <p>0 indicates that the device type is DHCP server.</p> <p>1 indicates that the device type is switch.</p> <p>2 indicates that the device type is LLDP MED .</p> |
| Command | LLDP Civic Address configuration mode |

| | |
|--------------------|--|
| Mode | |
| Usage Guide | After entering the LLDP Civic Address configuration mode, configure the device type. |

↘ Restoring the Device Type

| | |
|------------------------------|---|
| Command | no device-type |
| Parameter Description | N/A |
| Command Mode | LLDP Civic Address configuration mode |
| Usage Guide | After entering the LLDP Civic Address configuration mode, restore the default settings. |

Configuration Example

↘ Configuring the Civic Address of a Device

| | |
|----------------------------|--|
| Configuration Steps | Set the address of port GigabitEthernet 0/1 as follows: set country to CH, city to Fuzhou, and postal code to 350000. |
| | <pre>Ruijie#config Ruijie(config)#lldp location civic-location identifier 1 Ruijie(config-lldp-civic)# country CH Ruijie(config-lldp-civic)# city Fuzhou Ruijie(config-lldp-civic)# postal-code 350000</pre> |
| Verification | Display the LLDP civic address of port GigabitEthernet 0/1 1. |
| | <pre>civic location information: ----- Identifier :1 country :CH device type :1 city :Fuzhou postal-code :350000</pre> |

6.4.14 Configuring the Emergency Telephone Number

Configuration Effect

- Configure the emergency telephone number of a device.

Configuration Steps

- Optional.
- Perform this configuration in global configuration mode.

Verification

Display the emergency telephone number of the local device

- Check whether the configuration takes effect.

Related Commands

▾ Configuring the Emergency Telephone Number of a Device

| | |
|---------------------|--|
| Command | lldp location elin identifier <i>id</i> elin-location <i>tel-number</i> |
| Parameter | <i>id</i> : Indicates the identifier of an emergency telephone number. The value ranges from 1 to 1,024. |
| Description | <i>tel-number</i> : Indicates emergency telephone number, containing 10-25 characters. |
| Command Mode | Global configuration mode |
| Usage Guide | Run this command to configure the emergency telephone number. |

▾ Deleting the Emergency Telephone Number of a Device

| | |
|---------------------|--|
| Command | no lldp location elin identifier <i>id</i> |
| Parameter | <i>id</i> : Indicates the identifier of an emergency telephone number. The value ranges from 1 to 1,024. |
| Description | |
| Command Mode | Global configuration mode |
| Usage Guide | N/A |

Configuration Example

▾ Configuring the Emergency Telephone Number of a Device

| | |
|----------------------------|--|
| Configuration Steps | Set the emergency telephone number of port GigabitEthernet 0/1 to 08528555556. |
| | <pre>Ruijie#config Ruijie(config)#lldp location elin identifier 1 elin-location 085283671111</pre> |
| Verification | Display the emergency telephone number of port GigabitEthernet 0/1. |
| | <pre>elin location information: ----- Identifier :1 elin number :085283671111</pre> |

6.5 Monitoring

Clearing

 Running the **clear** commands may lose vital information and thus interrupt services.

| Description | Command |
|-----------------------------------|---|
| Clears LLDP statistics. | clear lldp statistics [interface <i>interface-name</i>] |
| Clears LLDP neighbor information. | clear lldp table [interface <i>interface-name</i>] |

Displaying

| Description | Command |
|---|---|
| Displays LLDP information on the local device, which will be organized as TLVs and sent to neighbors. | show lldp local-information [global interface <i>interface-name</i>] |
| Displays the LLDP civic address or emergency telephone number of a local device. | show lldp location { civic-location elin-location } { identifier <i>id</i> interface <i>interface-name</i> static } |
| Displays LLDP information on a neighbor. | show lldp neighbors [interface <i>interface-name</i>] [detail] |
| Displays the LLDP network policy configuration of the local device. | show lldp network-policy { profile [<i>profile-num</i>] interface <i>interface-name</i> } |
| Displays LLDP statistics. | show lldp statistics [global interface <i>interface-name</i>] |
| Displays LLDP status information. | show lldp status [interface <i>interface-name</i>] |
| Displays the configuration of TLVs to be advertised by a port. | show lldp tlv-config [interface <i>interface-name</i>] |

Debugging

 System resources are occupied when debugging information is output. Therefore, disable debugging immediately after use.

| Description | Command |
|------------------------------------|--------------------------|
| Debugs LLDP error processing. | debug lldp error |
| Debugs LLDP event processing. | debug lldp event |
| Debugs LLDP hot backup processing. | debug lldp ha |
| Debugs the LLDP packet reception. | debug lldp packet |
| Debugs the LLDP state machine. | debug lldp stm |

7 Configuring PPPoE-client

7.1 Overview

PPPoE: Point-to-point Protocol Over Ethernet

Ruijie products support the PPPoE client on Ethernet interfaces, and are therefore able to connect to a host network by accessing a remote hub through a simple access device. The PPPoE protocol enables the PPPoE server to control each access client and perform relevant accounting.

Ruijie products support two dialing modes: Dial-on-Demand Routing (DDR) and no Dial-on-Demand Routing (DDR) but always online.

- The PPPoE client is applicable in scenarios where Internet access is implemented through ADSL.

 The following sections describe the PPPoE client only.

Protocols and Standards

- RFC2516: A Method for Transmitting PPP Over Ethernet (PPPoE)
- RFC1661: The Point-to-Point Protocol (PPP)

7.2 Applications

| Application | Description |
|-------------------------------|--|
| ADSL Scenario | In a scenario where Internet access is implemented through the Asymmetric Digital Subscriber Line (ADSL) technology, the device provides dialup and packet forwarding functions. |

7.2.1 ADSL Scenario

Scenario

In a scenario where Internet access is implemented through ADSL, the device provides dialup and packet forwarding functions.

The dialup networking scenario is illustrated with Figure 7-1 as an example.

- The dialup function is enabled on the device. The device connects to a remote Internet service provider (ISP) over an ADSL line, and obtains Internet access capability.
- Intranet PCs access the Internet through the device.

Figure 7-1

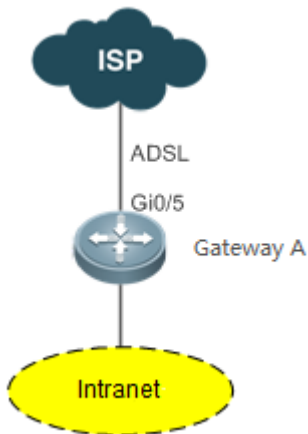

7.2.1.1 Corresponding Protocols

- Enable the dialup function on the device, and dial up to the Internet over the ADSL line.

7.3 Features

Basic Concepts

↳ ISP

A network operator who provides users with Internet access service, information service, and value-added services (VASs).

↳ ADSL

A line on which users dial up to the Internet.

↳ Data Flow

A flow of packets only forwarded by the device.

↳ Interested Flow

A specific type of packets defined by users during configuration, which can trigger the device to start dialup.

Overview

| Feature | Description |
|--|--|
| Dialup to the Internet | In a scenario where Internet access is implemented through the Asymmetric Digital Subscriber Line (ADSL) technology, the device provides dialup and packet forwarding functions. |

7.3.1 Dialup to the Internet

The device has Internet access capability after the dialup is complete; therefore, hosts in the intranet also have Internet access capability.

Working Principle

Dialup corresponds to the negotiation process, whereas Internet access corresponds to the packet forwarding process. Negotiation can be further divided into three parts: protocol negotiation, protocol keepalive, and protocol termination.

↘ Protocol Negotiation

Protocol negotiation is divided into PPPoE negotiation and PPP negotiation.

During PPPoE negotiation, both parties confirm a unique peer, record the peer's MAC address, and establish a unique session ID.

During PPP negotiation, the server checks the client's authentication information. If the client passes the authentication, the server allocates an IP address to the client. If the client has already been configured with an IP address and the configured IP address meets the server's requirements, the server will agree to use this IP address as the IP address of the client.

After both protocols are up, the device has Internet access capability and prepares a Layer 2 (L2) header that is necessary for data packet encapsulation.

↘ Protocol Keepalive

After PPP is up, both parties periodically send LCP heartbeat packets to each other. If the party at one end does not receive any heartbeat response from the other party, it actively terminates the protocol.

↘ Protocol Termination

In certain cases, either party may actively terminate the protocol.

The initiating party sends a PPP termination packet to end the current PPP session, and then sends a PPPoE termination packet to end the current PPPoE session.

After receiving the PPP termination packet, the passive party returns an acknowledgement packet to agree to the termination of the PPP session; and after receiving the PPPoE termination packet, the passive party returns another acknowledgement packet to agree to the termination of the PPPoE session.

Once either party receives a PPPoE termination protocol, the PPP session and the PPPoE session will immediately terminate, even if it has not received any PPP termination protocol.

↘ Packet Forwarding

Packet sending process: When a data packet is routed to the dialer interface, the device encapsulates the data packet with the prepared L2 header information and ultimately sends the data packet from a physical port.

Packet receiving process: After a packet arrives at a physical port, the device marks the Layer 3 (L3) header position of the packet, executes the next service, and ultimately sends the packet to a host in the intranet.

Related Configuration

▾ Configuring the Ethernet Interface

By default, the following functions are disabled and there is no corresponding default value.

Run the **pppoe enable** command to enable the PPPoE client function on the interface.

Run the **no pppoe enable** command to disable the PPPoE client function on the interface.

Run the **pppoe-client dial-pool-number** *pool-number* **dial-on-demand** command to bind the Ethernet interface to a specific logical dialer pool. The logical dialer pool provides **dial-on-demand**. It dials the PPPoE server only after it has received packets.

Run the **no pppoe-client dial-pool-number** *pool-number* command to unbind the Ethernet interface from the specific logical dialer pool.

▾ Configuring the Logical Interface

By default, the following functions are disabled.

Run the **interface dialer** *dialer-number* command to add a specific logical interface and enter the configuration mode of the logical interface.

Run the **no interface dialer** *dialer-number* command to delete the specific logical interface.

Run the **ip address negotiate** command to configure negotiation-based IP address acquisition.

Run the **no ip address negotiate** command to remove the configuration of negotiation-based IP address acquisition.

Run the **dialer pool** *number* command to associate a dialer pool, which corresponds to the dialer pool configured on the Ethernet interface.

Run the **no dialer pool** *number* command to remove the association with the dialer pool.

Run the **encapsulation ppp** command to configure the encapsulation protocol PPP. PPPoE is established on the basis of PPP.

Run the **no encapsulation** command to remove the encapsulation protocol configuration.

Run the **mtu** *1488* command to set the Maximum Transmit Unit (MTU) to 1488.

Run the **no mtu** command to remove the MTU configuration.

Run the **dialer-group** *dialer-group-number* command to associate a dialer triggering rule, which corresponds to the dialer-list.

Run the **no dialer-group** command to remove the configuration of the dialer triggering rule.

Run the **ppp chap hostname** *username* command to configure the user name for CHAP authentication.

Run the **no ppp chap hostname** command to remove the user name configuration for CHAP authentication.

Run the **ppp chap password** *password* command to configure the password for CHAP authentication.

Run the **no ppp chap password** command to remove the password configuration for CHAP authentication.

Run the **ppp pap sent-username** *username* **password** *password* command to configure the user name and password for PAH authentication.

Run the **no ppp pap sent-username** command to remove the user name and password configuration for PAH authentication.

↘ **Configuring Mandatory Global Parameters**

By default, the following functions are disabled and shall be configured according to actual requirements. If other functional modules need to be used together, you also need to configure other global parameters.

Run the **dialer-list number protocol** *protocol-name* { **permit** | **deny** | **list** *access-list-number* } command to define a dialer triggering rule.

Run the **no dialer-list number** command to delete the configured dialer triggering rule.

Run the **ip route** *0.0.0.0 0.0.0.0 dialer dialer-number* [**permanent**] command to configure a route. If you specify the **permanent** option, the route will be always valid, even if the logical interface is within the enable-timeout period, in which case the logical interface will be down.

Run the **no ip route** *0.0.0.0 0.0.0.0 dialer dialer-number* command to remove the route.

7.4 Configuration

| Configuration | Description and Command | |
|---|---|---|
| Configuring Basic Functions of the PPPoE Client |  Mandatory configuration. | |
| | pppoe enable | Enables the PPPoE client function. |
| | pppoe-client dial-pool-number <i>number</i> { dial-on-demand no-ddr } | Binds a logical dialer pool and specifies the dialing mode. |
| | interface dialer <i>dialer-number</i> | Adds a specific logical interface and enters the configuration mode of the logical interface. |
| | ip address { negotiate ip-addr <i>subnet-mask }</i> | Configures the IP address acquisition mode. |
| | dialer pool <i>number</i> | Associates a dialer pool. |
| | encapsulation ppp | Configures the encapsulation protocol PPP. |
| | mtu <i>1488</i> | Sets the MTU to 1488. |
| | dialer-group <i>dialer-group-number</i> | Associates a dialer triggering rule. |
| | ppp chap hostname <i>username</i> | Configures the user name for CHAP authentication. |
| | ppp chap password <i>password</i> | Configures the password for CHAP authentication. |
| | ppp pap sent-username <i>username</i> password <i>password</i> | Configures the user name and password for PAP authentication. |
| | dialer-list number protocol <i>protocol-name</i> { permit deny list access-list-number } | Defines a dialer triggering rule. |

7.4.1 Configuring Basic Functions of the PPPoE Client

Networking Requirements

- The device initiates PPPoE negotiation, and completes the negotiation process, protocol keepalive, and protocol termination.
- The device obtains Internet access capability after the negotiation is complete, and starts to forward a data flow which is routed to the dialer interface.

Notes

- After the kernel module is uninstalled, users can still perform configuration management but negotiation and data flow forwarding cannot be performed.

Configuration Steps

↘ Enabling the PPPoE Client Function

- The configuration is mandatory.
- Perform this configuration in Ethernet interface configuration mode.
- Enable the PPPoE client function.

↘ Binding a Logical Dialer Pool and Specifying the Dialing Mode

- The configuration is mandatory.
- Perform this configuration in Ethernet interface configuration mode.
- Bind the Ethernet interface to a specific logical dialer pool and specify the dialer mode.

↘ Adding a Specific Logical Interface and Entering the Configuration Mode of the Logical Interface

- The configuration is mandatory.
- Perform this configuration in global configuration mode.
- Add a specific logical interface and enter its configuration mode.

↘ Configuring the Way of Acquiring the IP Address of the Logical Interface

- The configuration is mandatory.
- Perform this configuration in logical interface configuration mode.
- Configure the way of acquiring the IP address of the logical interface.

↘ Associating a Dialer Pool

- The configuration is mandatory.
- Perform this configuration in logical interface configuration mode.
- Associate the logical interface with a specific dialer pool.

↘ Configuring the Encapsulation Protocol

- The configuration is mandatory.
- Perform this configuration in logical interface configuration mode.
- Configure the encapsulation protocol PPP on the logical interface.

↘ Configuring the MTU of the Logical Interface

- The configuration is mandatory.
- Perform this configuration in logical interface configuration mode.
- Set the MTU of the logical interface to 1488.

↘ Associating a Dialer Triggering Rule

- The configuration is mandatory.
- Perform this configuration in logical interface configuration mode.
- Associate a dialer triggering rule.

↘ **Configuring the User Name for CHAP Authentication**

- The configuration is mandatory.
- Perform this configuration in logical interface configuration mode.
- Configure the user name for CHAP authentication.

↘ **Configuring the Password for CHAP Authentication**

- The configuration is mandatory.
- Perform this configuration in logical interface configuration mode.
- Configure the password for CHAP authentication.

↘ **Configuring the User Name and Password for PAP Authentication**

- The configuration is mandatory.
- Perform this configuration in logical interface configuration mode.
- Configure the user name and password for PAP authentication.

↘ **Defining a Dialer Triggering Rule**

- The configuration is mandatory.
- Perform this configuration in global configuration mode.
- Define a dialer triggering rule.

Verification

- Check whether the dialer interface has acquired an IP address.
- Check whether a correct dialer interface route entry has been established on the device.

Related Commands

↘ **Enabling the PPPoE Client Function**

| | |
|------------------------------|---|
| Command Syntax | pppoe enable |
| Parameter Description | N/A |
| Command Mode | Interface configuration mode |
| Configuration | The interface on which the PPPoE client will be enabled must be a WAN Ethernet interface. |

| | |
|-------|--|
| Usage | |
|-------|--|

↘ Binding a Logical Dialer Pool and Specifying the Dialing Mode

| | |
|-----------------------|--|
| Command Syntax | pppoe-client dial-pool-number <i>number</i> { dial-on-demand no-ddr } |
| Parameter Description | <i>number</i> : number of the dialer pool |
| Command Mode | Interface configuration mode |
| Configuration Usage | The PPPoE client function must be enabled on the interface first. |

↘ Adding a Specific Logical Interface and Entering its Configuration Mode

| | |
|-----------------------|--|
| Command Syntax | interface dialer <i>dialer-number</i> |
| Parameter Description | <i>dialer-number</i> : interface number |
| Command Mode | Global configuration mode |
| Configuration Usage | N/A |

↘ Configuring the Way of Acquiring the IP Address of the Logical Interface

| | |
|-----------------------|---|
| Command Syntax | ip address { negotiate <i>ip-addr subnet-mask</i> } |
| Parameter Description | <i>ip-addr</i> : manually configured IP address <i>subnet-mask</i> : manually configured subnet mask |
| Command Mode | Interface configuration mode |
| Configuration Usage | If you select negotiate , the IP address of the dialer interface will be acquired through negotiation. If you manually specify the IP address of the dialer interface, the peer's consent is required during negotiation for the device to work properly. |

↘ Associating a Dialer Pool

| | |
|-----------------------|---|
| Command Syntax | dialer pool <i>number</i> |
| Parameter Description | <i>number</i> : number of the dialer pool |
| Command Mode | Interface configuration mode |
| Configuration Usage | An Ethernet interface will be selected from the dialer pool as the dialer interface to perform dialing. |

↘ Configuring the Encapsulation Protocol

| | |
|------------------------------|------------------------------|
| Command Syntax | encapsulation ppp |
| Parameter Description | N/A |
| Command Mode | Interface configuration mode |
| Configuration Usage | N/A |

↘ Configuring the MTU of the Logical Interface

| | |
|------------------------------|---|
| Command Syntax | mtu 1488 |
| Parameter Description | N/A |
| Command Mode | Interface configuration mode |
| Configuration Usage | Because Internet access is implemented through the PPPoE protocol, the L2 header of a packet is longer than that of a common Ethernet packet. |

↘ Associating a Dialer Triggering Rule

| | |
|------------------------------|--|
| Command Syntax | dialer-group dialer-group-number |
| Parameter Description | <i>dialer-group-number</i> : number of the dialer triggering rule |
| Command Mode | Interface configuration mode |
| Configuration Usage | If the DDR mode is specified, the device will be triggered to perform dialing only when a packet meeting the rule is routed to the dialer interface. If the no-DDR mode is specified, the configuration will not take effect on the device. |

↘ Configuring the User Name for CHAP Authentication

| | |
|------------------------------|-----------------------------------|
| Command Syntax | ppp chap hostname username |
| Parameter Description | <i>username</i> : user name |
| Command Mode | Interface configuration mode |
| Configuration Usage | N/A |

↘ Configuring the Password for CHAP Authentication

| | |
|------------------------------|-----------------------------------|
| Command Syntax | ppp chap password password |
| Parameter Description | <i>password</i> : password |

| | |
|----------------------------|------------------------------|
| Description | |
| Command Mode | Interface configuration mode |
| Configuration Usage | N/A |

↘ Configuring the User Name and Password for PAP Authentication

| | |
|------------------------------|--|
| Command Syntax | ppp pap sent-username <i>username</i> password <i>password</i> |
| Parameter Description | <i>username</i> : user name <i>password</i> : password |
| Command Mode | Interface configuration mode |
| Configuration Usage | N/A |

↘ Defining a Dialer Triggering Rule

| | |
|------------------------------|--|
| Command Syntax | dialer-list number protocol <i>protocol-name</i> { permit deny list access-list-number } |
| Parameter Description | <i>protocol-name</i> : protocol name <i>access-list-number</i> : ACL number |
| Command Mode | Global configuration mode |
| Configuration Usage | N/A |

Configuration Example

i The following configuration example describes configuration related to the PPPoE client only.

↘ In the ADSL scenario, enable the PPPoE client function and access the Internet through an ADSL line.

Scenario

Figure 7-2

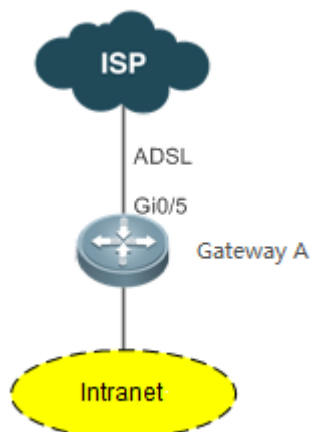

| | |
|----------------------------|---|
| Configuration Steps | <ul style="list-style-type: none"> ● Enable the PPPoE client function on the device, and add the interface Gi0/5 to the dialer pool. |
| | <pre> A# configure terminal A(config)# interface GigabitEthernet 0/5 A(config-if)# pppoe enable A(config-if)# pppoe-client dial-pool-number 1 dial-on-demand A(config-if)# exit A(config)# interface dialer 1 A(config-if)# ip address negotiate A(config-if)# mtu 1488 A(config-if)# encapsulation ppp A(config-if)# ip nat outside A(config-if)# dialer pool 1 A(config-if)# dialer-group 1 A(config-if)# ppp chap hostname pppoe A(config-if)# ppp chap password pppoe A(config-if)# ppp pap sent-username pppoe password pppoe A(config-if)# exit A(config)# access-list 1 permit any A(config)# dialer-list 1 protocol ip permit A(config)# ip nat inside source list 1 interface dialer 1 A(config)# ip route 0.0.0.0 0.0.0.0 dialer 1 A(config)# end A# </pre> |
| Verification | <p>Run the show ip interface brief in dialer 1 command to check whether the dialer interface has acquired an IP address.</p> <p>Run the show ip route command to check whether a correct dialer interface route entry has been established.</p> <pre> A# show ip interface brief in dialer 1 dialer 1 49.1.1.127/32 YES UP A# show ip route </pre> |

```

Codes: C - connected, S - static, R - RIP, B - BGP
       O - OSPF, IA - OSPF inter area
       N1 - OSPF NSSA external type 1, N2 - OSPF NSSA external type 2
       E1 - OSPF external type 1, E2 - OSPF external type 2
       i - IS-IS, su - IS-IS summary, L1 - IS-IS level-1, L2 - IS-IS level-2
       ia - IS-IS inter area, * - candidate default

Gateway of last resort is 0.0.0.0 to network 0.0.0.0

S*  0.0.0.0/0 is directly connected, dialer 1
C   10.10.3.0/24 is directly connected, GigabitEthernet 0/0
C   10.10.3.1/32 is local host.
C   10.202.172.1/32 is directly connected, dialer 1
C   49.1.1.127/32 is local host.

```

Common Errors

- The negotiation fails because the user name or password is incorrect.
- Intranet hosts cannot access the Internet because NAT configuration is incorrect.
- Intranet hosts cannot access the Internet because route configuration is incorrect.

7.5 Monitoring

7.5.1 Clearing Various Information

 If you run the **clear pppoe tunnel** command while the device is operating, packet forwarding will be interrupted due to tunnel clearance.

| Function | Command |
|---|--|
| Clears statistics about the DDR dialer interface. | clear dialer [<i>interface-type interface-number</i>] |
| Clears the tunnel. | clear pppoe tunnel |

7.5.2 Displaying the Running Status

| Function | Command |
|------------------------------------|--|
| Displays information about the DDR | show dialer [interface type number] [maps] [pools] |

| | |
|------------------------------------|--|
| dialer. | |
| Displays PPPoE status information. | show pppoe { ref session tunnel } |

7.5.3 Displaying Debugging Information

 System resources are occupied when debugging information is output. Therefore, disable the debugging switch immediately after use.

| Command | Function |
|--|---|
| debug dialer { pkt mlp callback event } | Enables the DDR debugging switch. |
| debug ppp [authentication error event negotiation packet] | Enables the PPP negotiation debugging switch. |
| debug pppoe [datas errors events packets] | Enables the PPPoE negotiation debugging switch. |



IP Address & Application Configuration

1. Configuring IP Addresses and Services
2. Configuring ARP
3. Configuring IPv6
4. Configuring DHCP
5. Configuring DNS
6. Configuring Network Communication Test Tool
7. Configuring TCP
8. Configuring IPv4/IPv6 REF
9. Configuring NAT

1 Configuring IP Addresses and Services

1.1 Overview

Internet Protocol (IP) sends packets to the destination from the source by using logical (or virtual) addresses, namely IP addresses. At the network layer, routers forward packets based on IP addresses.

Protocols and Standards

- RFC 1918: Address Allocation for Private Internets
- RFC 1166: Internet Numbers

1.2 Applications

| Application | Description |
|---|--|
| Configuring an IP Address for Communication | Two networks communicate through one switch interface. |

1.2.1 Configuring an IP Address for Communication

Scenario

A switch is connected to a Local Area Network (LAN), which is divided into two network segments, namely, 172.16.1.0/24 and 172.16.2.0/24. Computers in the two network segments can communicate with the Internet through switches and computers between the two network segments can communicate with each other.

Figure 1-1 Configuring IP Addresses

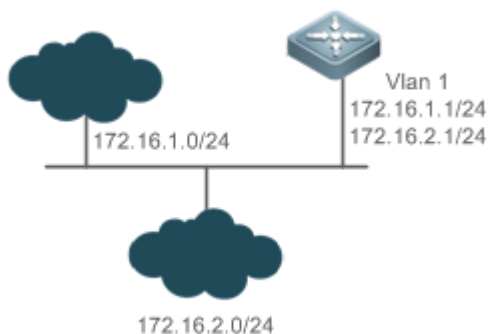

Deployment

- Configure two IP addresses on VLAN1. One is a primary IP address and the other is a secondary IP address.

- On hosts in the network segment 172.16.1.0/24, set the gateway to 172.16.1.1; on hosts in the network segment 172.16.2.0/24, set the gateway to 172.16.2.1.

1.3 Features

Basic Concepts

▾ IP Address

An IP address consists of 32 bits in binary. To facilitate writing and description, an IP address is generally expressed in decimal. When expressed in decimal, an IP address is divided into four groups, with eight bits in each group. The value range of each group is from 0 to 255, and groups are separated by a full stop ".". For example, "192.168.1.1" is an IP address expressed in decimal.

IP addresses are used for interconnection at the IP layer. A 32-bit IP address consists of two parts, namely, the network bits and the host bits. Based on the values of the first several bits in the network part, IP addresses in use can be classified into four classes.

For a class A address, the most significant bit is 0. 7 bits indicate a network ID, and 24 bits indicate a local address. There are 128 class A networks in total.

Figure 1-2

| | | | | | | | |
|--------------------|---|--|------------|---------|----|----|----|
| | | | | 8 | 16 | 24 | 32 |
| Class A IP address | 0 | | Network ID | Host ID | | | |

For a class B address, the first two most significant bits are 10. 14 bits indicate a network ID, and 16 bits indicate a local address. There are 16,384 class B networks in total.

Figure 1-3

| | | | | | | | |
|--------------------|---|---|------------|---------|----|----|----|
| | | | | 8 | 16 | 24 | 32 |
| Class B IP address | 1 | 0 | Network ID | Host ID | | | |

For a class C address, the first three most significant bits are 110. 21 bits indicate a network ID, and 8 bits indicate a local address. There are 2,097,152 class C networks in total.

Figure 1-4

| | | | | | | | | |
|--------------------|---|---|---|------------|---|----|---------|----|
| | | | | | 8 | 16 | 24 | 32 |
| Class C IP address | 1 | 1 | 0 | Network ID | | | Host ID | |

For a class D address, the first four most significant bits are 1110 and other bits indicate a multicast address.

Figure 1-5

| | | | | | | | | |
|--------------------|---|---|---|---|-------------------|----|----|----|
| | | | | | 8 | 16 | 24 | 32 |
| Class D IP address | 1 | 1 | 1 | 0 | Multicast address | | | |

i The addresses with the first four most significant bits 1111 cannot be assigned. These addresses are called class E addresses and are reserved.

When IP addresses are planned during network construction, IP addresses must be assigned based on the property of the network to be built. If the network needs to be connected to the Internet, users should apply for IP addresses to the corresponding agency. In China, you can apply to China Internet Network Information Center (CNNIC) for IP addresses. Internet Corporation for Assigned Names and Numbers (ICANN) is the final organization responsible for IP address assignment. If the network to be built is an internal private network, users do not need to apply for IP addresses. However, IP addresses cannot be assigned at random. It is recommended to assign dedicated private network addresses.

The following table lists reserved and available addresses.

| Class | Address Range | Status |
|-----------------|---------------------------------|-------------------|
| Class A network | 0.0.0.0 - 0.255.255.255 | Reserved |
| | 1.0.0.0 - 126.255.255.255 | Available |
| | 127.0.0.0 - 127.255.255.255 | Reserved |
| Class B network | 128.0.0.0 - 191.254.255.255 | Available |
| | 191.255.0.0 - 191.255.255.255 | Reserved |
| Class C network | 192.0.0.0 - 192.0.0.255 | Reserved |
| | 192.0.1.0 - 223.255.254.255 | Available |
| | 223.255.255.0 - 223.255.255.255 | Reserved |
| Class D network | 224.0.0.0 - 239.255.255.255 | Multicast address |
| Class E network | 240.0.0.0 - 255.255.255.254 | Reserved |
| | 255.255.255.255 | Broadcast address |

Three address ranges are dedicated to private networks. These addresses are not used in the Internet. If the networks to which these addresses are assigned need to be connected to the Internet, these IP addresses need to be converted into valid Internet addresses. The following table lists private address ranges. Private network addresses are defined in RFC 1918.

| Class | Address Range | Status |
|-----------------|-------------------------------|----------------------|
| Class A network | 10.0.0.0 - 10.255.255.255 | 1 class A network |
| Class B network | 172.16.0.0 - 172.31.255.255 | 16 class B networks |
| Class C network | 192.168.0.0 - 192.168.255.255 | 256 class C networks |

For assignment of IP addresses, TCP/UDP ports, and other codes, refer to RFC 1166.

Subnet Mask

A subnet mask is also a 32-bit value. The bits that identify the IP address are the network address. In a subnet mask, the IP address bits corresponding to the bits whose values are 1s are the network address, and the IP address bits corresponding to the bits whose values are 0s are the host address. For example, for class A networks, the subnet mask is 255.0.0.0. By using network masks, you can divide a network into several subnets. Subnetting means to use some bits of the host address as the network address, thus decreasing the host capacity, and increasing the number of networks. In this case, network masks are called subnet masks.

Broadcast Packet

Broadcast packets refer to the packets destined for all hosts on a physical network. Ruijie products support two types of broadcast packets: (1) directed broadcast, which indicates that all hosts on the specified network are packet receivers and the host bits of a destination address are all 1s; (2) limited broadcast, which indicates that all hosts on all networks are packet receivers and the 32 bits of a destination address are all 1s.

ICMP Packet

Internet Control Message Protocol (ICMP) is a sub-protocol in the TCP/IP suite for transmitting control messages between IP hosts and network devices. It is mainly used to notify corresponding devices when the network performance becomes abnormal.

TTL

Time To Live (TTL) refers to the number of network segments where packets are allowed to pass before the packets are discarded. The TTL is a value in an IP packet. It informs the network whether packets should be discarded as the packets stay on the network for a long time.

Features

| Feature | Description |
|--|--|
| IP Address | The IP protocol can run on an interface only after the interface is configured with an IP address. |
| Broadcast Packet Processing | Broadcast addresses are configured and broadcast packets are forwarded and processed. |
| Sending ICMP Packets | ICMP packets are sent and received. |
| Limiting Transmission Rate of ICMP Error Packets | This function prevents Denial of Service (DoS) attacks. |
| IP MTU | Maximum Transmission Unit (MTU) of IP packets on an interface is configured. |
| IP TTL | The TTL of unicast packets and broadcast packets is configured. |
| IP Source Route | Source routes are checked. |

1.3.1 IP Address

IP addresses are obtained on an interface in the following ways:

1. Manually configuring IP addresses
2. Obtaining IP addresses through DHCP
3. Obtaining IP addresses through PPP negotiation
4. Borrowing IP addresses of other interfaces

These approaches are mutually exclusive. If you configure a new approach to obtain an IP address, the old IP address will be overwritten.

 For details on how to obtain IP addresses through DHCP, see the “DHCP” chapter. The following describes the other three approaches for obtaining IP addresses.

Configuring the IP Address for an Interface

A device can receive and send IP packets only after the device is configured with an IP address. Only the interface configured with an IP address can run the IP protocol.

Configuring Multiple IP Addresses for an Interface

Ruijie products support multiple IP address configuration on one interface, of which one is a primary IP address and the others are secondary IP addresses or slave addresses. Theoretically, the number of secondary IP addresses is not limited. However, secondary IP addresses must belong to different networks and secondary IP addresses must be in different networks from primary IP addresses. In network construction, secondary IP addresses are often used in the following circumstances:

- A network does not have enough host addresses. For example, a LAN now needs one class C network to allocate 254 addresses. However, when the number of hosts exceeds 254, one class C network is not enough and another class C network is needed. In this case, two networks need to be connected. Therefore, more IP addresses are needed.
- Many old networks are based on L2 bridged networks without subnetting. You can use secondary IP addresses to upgrade the network to a routing network based on IP layer. For each subnet, one device is configured with one IP address.
- When two subnets of one network are isolated by another network, you can connect the isolated subnets by creating a subnet of the isolated network and configuring a secondary address. One subnet cannot be configured on two or more interfaces of a device.

 Before configuring secondary IP addresses, make sure that primary IP addresses are configured. If one device in a network is configured with a secondary IP address, other devices must be configured with secondary IP addresses in the same network. If other devices are not configured with IP addresses, the secondary addresses can be set to primary IP addresses.

Obtaining an IP Addresses through PPP Negotiation

 This command is supported on point-to-point interfaces only.

Through this configuration, a point-to-point interface accepts the IP address assigned by the peer end through PPP negotiation.

↳ Borrowing an IP Addresses from Another Interface

One interface may not be configured with an IP address. To enable the interface, it must borrow an IP address from another interface.

- ❗ IP addresses of Ethernet interfaces, tunnel interfaces, and loopback interfaces can be borrowed. However, these interfaces cannot borrow IP addresses from other interfaces.
- ❗ The IP addresses of borrowed interfaces cannot be borrowed from other interfaces.
- ❗ If a borrowed interface has multiple IP addresses, only the primary IP address can be borrowed.
- ❗ The IP address of one interface can be lent to multiple interfaces.
- ❗ IP addresses of borrowing interfaces are always consistent with and vary with IP addresses of borrowed interfaces.

Related Configuration

↳ Configuring an Interface with One or More IP Addresses

- By default, an interface is not configured with an IP address.
- The **ip address** command is used to configure an IP address for an interface.
- After an IP address is configured, the IP address can be used for communication when it passes conflict detection.
- The **ip address ip-address mask secondary** command can be used to configure multiple secondary IP addresses.

↳ Obtaining an IP Address through PPP Negotiation

- By default, the interface cannot obtain an IP address through PPP negotiation.
- The **ip address negotiate** command is used to configure IP address negotiation on a point-to-point interface.

↳ Borrowing an IP Address from Other Interfaces

- By default, an interface is not configured with an IP address.
- The **ip unnumbered** command can be used to borrow IP addresses from other interfaces.

1.3.2 Broadcast Packet Processing

Working Principle

Broadcast is divided into two types. One is limited broadcast, and the IP address is 255.255.255.255. Because the broadcast is prohibited by routers, the broadcast is called local network broadcast. The other is directed broadcast. All host bits are 1s, for example, 192.168.1.255/24. The broadcast packets with these IP addresses can be forwarded.

If IP network devices forward limited broadcast packets (destination IP address is 255.255.255.255), the network may be overloaded, which severely affects network performance. This circumstance is called broadcast storm. Devices provide some approaches to confine broadcast storms within the local network and prevent continuous spread of broadcast storms. L2 network devices such as bridges and switches forward and spread broadcast storms.

The best way to avoid broadcast storm is to assign a broadcast address to each network, which is directed broadcast. This requires the IP protocol to use directed broadcast rather than limited broadcast to spread data.

For details about broadcast storms, see RFC 919 and RFC 922.

Directed broadcast packets refer to the broadcast packets destined for a subnet. For example, packets whose destination address is 172.16.16.255 are called directed broadcast packets. However, the node that generates the packets is not a member of the destination subnet.

After receiving directed broadcast packets, the devices not directly connected to the destination subnet forward the packets. After directed broadcast packets reach the devices directly connected to the subnet, the devices convert directed broadcast packets to limited broadcast packets (destination IP address is 255.255.255.255) and broadcast the packets to all hosts on the destination subnet at the link layer.

Related Configuration

▾ Configuring an IP Broadcast Address

- By default, the IP broadcast address of an interface is 255.255.255.255.
- To define broadcast packets of other addresses, run the **ip broadcast-address** command on the interface.

▾ Forwarding Directed Broadcast Packets

- By default, directed broadcast packets cannot be forwarded.
- On the specified interface, you can run the **ip directed-broadcast** command to enable directed broadcast packets forwarding. In this way, the interface can forward directed broadcast packets to networks that are directly connected. Broadcast packets can be transmitted within the destination subnet without affecting forwarding of other directed broadcast packets.
- On an interface, you can define an Access Control List (ACL) to transmit certain directed broadcast packets. After an ACL is defined, only directed broadcast packets that match the ACL are forwarded.

1.3.3 Sending ICMP Packets

Working Principle

▾ ICMP Protocol Unreachable Message

A device receives non-broadcast packets destined for itself, and the packets contain the IP protocol that cannot be processed by the device. The device sends an ICMP protocol unreachable message to the source host. Besides, if the device does not know a route to forward packets, it also sends an ICMP host unreachable message.

▾ ICMP Redirection Message

Sometimes, a route may be less than optimal, which makes a device send packets from the interface that receives packets. If a device sends packets from an interface on which it receives the packets, the device sends an ICMP redirection message to the source, informing the source that the gateway is another device on the same subnet. In this way, the source sends subsequent packets according to the optimal path.

↘ ICMP Mask Response Message

Sometimes, a network device sends an ICMP mask request message to obtain the mask of a subnet. The network device that receives the ICMP mask request message sends a mask response message.

Related Configuration

↘ Enabling ICMP Protocol Unreachable Message

- By default, the ICMP Protocol unreachable message function is enabled on an interface.
- You can run the **[no] ip unreachable** command to disable or enable the function.

↘ Enabling ICMP Redirection Message

- By default, the ICMP redirection message function is enabled on an interface.
- You can run the **[no] ip redirects** command to disable or enable the function.

↘ Enabling ICMP Mask Response Message

- By default, the ICMP mask response message function is enabled on an interface.
- You can run the **[no] ip mask-reply** command to disable or enable the function.

↘ Enabling Notifications of Expired TTL

- By default, notifications of expired TTL are enabled.
- You can run the **[no] ip ttl-expires enable** command to enable or disable the function.

↘ Enabling Returning of Timestamp Reply

- By default, a Timestamp Reply is not sent.
- You can run the **[no] ip icmp timestamp** command to enable or disable the function.

1.3.4 Limiting Transmission Rate of ICMP Error Packets

Working Principle

This function limits the transmission rate of ICMP error packets to prevent DoS attacks by using the token bucket algorithm.

If an IP packet needs to be fragmented but the Don't Fragment (DF) bit in the header is set to 1, the device sends an ICMP destination unreachable packet (code 4) to the source host. This ICMP error packet is used to discover the path MTU. When there are too many other ICMP error packets, the ICMP destination unreachable packet (code 4) may not be sent. As a result, the path MTU discovery function fails. To avoid this problem, you should limit the transmission rate of ICMP destination unreachable packets and other ICMP error packets respectively.

Related Configuration

↘ Configuring the Transmission Rate of ICMP Destination Unreachable Packets Triggered by DF Bit in the IP Header

- The default transmission rate is 10 packets every 100 milliseconds.
- The **ip icmp error-interval DF** command can be used to configure the transmission rate.

📄 **Configuring the Transmission Rate of Other ICMP Error Packets**

- The default transmission rate is 10 packets every 100 milliseconds.
- The **ip icmp error-interval** command can be used to configure the transmission rate.

1.3.5 IP MTU

Working Principle

If an IP packet exceeds the IP MTU size, the RGOS software splits the packet. For all devices in the same physical network segment, the IP MTU of interconnected interfaces must be the same. You can adjust the link MTU of interfaces on Ruijie products. After the link MTU of interfaces is changed, the IP MTU of interfaces will be changed. The IP MTU of interfaces automatically keeps consistent with the link MTU of interfaces. However, if the IP MTU of interfaces is adjusted, the link MTU of interfaces will not be changed.

Related Configuration

📄 **Setting the IP MTU**

- By default, the IP MTU of an interface is 1500.
- The **ip mtu** command can be used to set the IP packet MTU.

1.3.6 IP TTL

Working Principle

An IP packet is transmitted from the source address to the destination address through routers. After a TTL value is set, the TTL value decreases by 1 every time when the IP packet passes a router. When the TTL value drops to zero, the router discards the packet. This prevents infinite transmission of useless packets and waste of bandwidth.

Related Configuration

📄 **Setting the IP TTL**

- By default, the IP TTL of an interface is 64.
- The **ip ttl** command can be used to set the IP TTL of an interface.

1.3.7 IP Source Route

Working Principle

Ruijie products support IP source routes. When a device receives an IP packet, it checks the options such as source route, loose source route, and record route in the IP packet header. These options are detailed in RFC 791. If the device detects

that the packet enables one option, it responds; if the device detects an invalid option, it sends an ICMP parameter error message to the source and then discards the packet.

After the IP source route is enabled, the source route option is added to an IP packet to test the throughput of a specific network or help the packet bypasses the failed network. However, this may cause network attacks such as source address spoofing and IP spoofing.

Related Configuration

↘ [Configuring an IP Source Route](#)

- By default, the IP source route function is enabled.
- The **ip source-route** command can be used to enable or disable the function.

1.3.8 IP Address Pool

Working Principle

A point-to-point interface can assign an IP address to the peer end through PPP negotiation. During PPP negotiation, the server checks authentication information of the client. If the client passes the authentication, the server assigns an IP address to the client (if the client is configured with an IP address and the IP address meets requirements of the server, the server approves the IP address of the client). The IP address of the peer end can be directly specified or assigned from the address pool.

Related Configuration

↘ [Enabling the Address Pool Function](#)

- By default, the address pool function is enabled.
- The **ip address-pool local** command can be used to enable or disable the function.

↘ [Creating an Address Pool](#)

- By default, no IP address pool is configured.
- The **ip local pool** command can be used to create or delete an address pool.

↘ [Assigning an IP Address to the Peer End through PPP Negotiation](#)

- By default, an interface does not assign an IP address to the peer end.
- The **peer default ip address** command can be used to assign an IP address to the peer end.

1.4 Configuration

| Configuration | Description and Command |
|---------------|-------------------------|
|---------------|-------------------------|

| Configuration | Description and Command | |
|---|---|--|
| Configuring the IP Addresses of an Interface |  (Mandatory) It is used to configure an IP address and allow the IP protocol to run on an interface. | |
| | ip address | Manually configures the IP address of an interface. |
| | ip address negotiate | Obtains the IP address of an interface through PPP negotiation. |
| | ip unnumbered | Borrows an IP address from another interface. |
| Configuring Broadcast Forwarding |  (Optional) It is used to set an IP broadcast address and enable directed broadcast forwarding. | |
| | ip broadcast-address | Configures an IP broadcast address. |
| | ip directed-broadcast | Enables directed broadcast forwarding. |
| Configuring ICMP Forwarding |  (Optional) It is used to enable ICMP packet forwarding. | |
| | ip unreachable | Enables ICMP unreachable messages and host unreachable messages. |
| | ip redirects | Enables ICMP redirection messages. |
| | ip mask-reply | Enables ICMP mask response messages. |
| | ip ttl-expires enable | Enables notifications of expired TTL. |
| | ip icmp timestamp | Enables returning of Timestamp Reply. |
| Configuring the Transmission Rate of ICMP Error Packets |  Optional. | |
| | ip icmp error-interval DF | Configures the transmission rate of ICMP destination unreachable packets triggered by the DF bit in the IP header. |
| | ip icmp error-interval | Configures the transmission rate of ICMP error packets and ICMP redirection packets. |
| Setting the IP MTU |  (Optional) It is used to configure the IP MTU on an interface. | |
| | ip mtu | Sets the MTU value. |
| Setting the IP TTL |  (Optional) It is used to configure the TTL of unicast packets and broadcast packets. | |
| | ip ttl | Sets the TTL value. |
| Configuring an IP Source Route |  (Optional) It is used to check the source routes. | |
| | ip source-route | Enables the IP source route function. |

1.4.1 Configuring the IP Addresses of an Interface

Configuration Effect

Configure the IP address of an interface for communication.

Notes

- N/A

Configuration Steps

▾ Configuring the IP Address of an Interface

- Mandatory
- Perform the configuration in L3 interface configuration mode.

▾ Obtaining the IP Address of an Interface through PPP Negotiation

- If a point-to-point interface is not configured with an IP address, obtain an IP address through PPP negotiation.
- Perform the configuration in L3 interface configuration mode.

▾ Borrowing an IP Address from Another Interface

- Optional
- If a point-to-point interface is not configured with an IP address, borrow an IP address from another interface.
- Perform the configuration in L3 interface configuration mode.

Verification

Run the **show ip interface** command to check whether the configuration takes effect.

Related Commands

▾ Manually Configuring the IP Address of an Interface

| | |
|------------------------------|--|
| Command | ip address <i>ip-address network-mask</i> [secondary] |
| Parameter Description | <i>ip-address</i> : 32-bit IP address, with 8 bits for each group. The IP address is expressed in decimal and groups are separated by a full stop (.). <i>network-mask</i> : 32-bit network mask. Value 1 indicates the mask bit and 0 indicates the host bit. Every 8 bits form one group. The network mask is expressed in decimal and groups are separated by a full stop (.). secondary : Secondary IP address. |
| Command Mode | Interface configuration mode |
| Usage Guide | N/A |

▾ Obtaining an IP Address of an Interface through PPP Negotiation

| | |
|------------------------------|-----------------------------|
| Command | ip address negotiate |
| Parameter Description | N/A |

| | |
|---------------------|--|
| Command Mode | Interface configuration mode |
| Usage Guide | Only point-to-point interfaces support obtaining IP addresses through PPP negotiation. After the ip address negotiate command is run on an interface, run the peer default ip address command at the peer end. |

↳ Borrowing an IP Addresses from Another Interface

| | |
|---------------------|--|
| Command | ip unnumbered <i>interface-type interface-number</i> |
| Parameter | <i>interface-type</i> : Interface type. |
| Description | <i>interface-number</i> : Interface ID. |
| Command Mode | Interface configuration mode |
| Usage Guide | <p>An unnumbered interface indicates that the interface is enabled with the IP protocol without an IP address assigned. An unnumbered interface needs to be associated with an interface configured with an IP address. For an IP packet generated on an unnumbered interface, the source IP address of the packet is the IP address of the associated interface. In addition, the routing protocol process decides whether to send a route update packet to the unnumbered interface according to its associated IP address. If you want to use an unnumbered interface, pay attention to the following limitations:</p> <p>An Ethernet interface cannot be set to an unnumbered interface.</p> <p>When a serial interface encapsulates SLIP, HDLC, PPP, LAPB, and Frame-Relay, the serial interface can be set to an unnumbered interface. During Frame</p> <p>-Relay encapsulation, however, only a point-to-point interface can be configured as an unnumbered interface. AnX.25 interface cannot be configured as an unnumbered interface.</p> <p>The ping command cannot be used to check whether an unnumbered interface is working properly because an unnumbered interface is not configured with an IP address. However, you can monitor the status of an unnumbered interface remotely through SNMP.</p> <p>A device cannot be cold started through an unnumbered interface.</p> |

Configuration Example

↳ Configuring an IP Address for an Interface

| | |
|----------------------------|--|
| Configuration Steps | Configure IP address 192.168.23.110 255.255.255.0 on interface GigabitEthernet 0/0. |
| | <pre>Ruijie#configure terminal Ruijie(config)#interface gigabitEthernet 0/0 Ruijie(config-if-GigabitEthernet 0/0)# no switchport Ruijie(config-if-GigabitEthernet 0/0)#ip address 192.168.23.110 255.255.255.0</pre> |
| Verification | Run the show ip interface command to check whether the configuration takes effect. |
| | <pre>Ruijie# show ip interface gigabitEthernet 0/0</pre> |

| | |
|--|--|
| | <pre>GigabitEthernet 0/0 IP interface state is: UP IP interface type is: BROADCAST IP interface MTU is: 1500 IP address is: 192.168.23.110/24 (primary)</pre> |
|--|--|

📌 Obtaining the IP Address of an Interface through PPP Negotiation

| | |
|----------------------------|---|
| Configuration Steps | Obtain the IP address of an interface through PPP negotiation. |
| | <pre>Ruijie(config)#int virtual-ppp 1 Ruijie(config-if-Virtual-ppp 1)#ip address negotiate</pre> |
| Verification | Run the show run command on the AC to display the configuration. |
| | <pre>Ruijie#show run interface virtual-ppp 1 Building configuration... Current configuration: 48 bytes interface Virtual-ppp 1 ip address negotiate</pre> |

1.4.2 Configuring Broadcast Forwarding

Configuration Effect

Set the broadcast address of an interface to 0.0.0.0 and enable directed broadcast forwarding.

Notes

N/A

Configuration Steps

📌 Configuring an IP Broadcast Address

- (Optional) Some old hosts may identify broadcast address 0.0.0.0 only. In this case, set the broadcast address of the target interface to 0.0.0.0.
- Perform the configuration in L3 interface configuration mode.

▾ Enabling Directed Broadcast Forwarding

- (Optional) If you want to enable a host to send broadcast packets to all hosts in a domain that it is not in, enable directed broadcast forwarding.
- Perform the configuration in L3 interface configuration mode.

Verification

Run the **show running-config interface** command to check whether the configuration takes effect.

Related Commands

▾ Configuring an IP Broadcast Address

| | |
|------------------------------|---|
| Command | ip broadcast-address <i>ip-address</i> |
| Parameter Description | <i>ip-address</i> : Broadcast address of an IP network. |
| Command Mode | Interface configuration mode |
| Usage Guide | Generally, the destination address of IP broadcast packets is all 1s, which is expressed as 255.255.255.255. The RGOS software can generate broadcast packets of other IP addresses through definition and receive self-defined broadcast packets and the broadcast packets with address 255.255.255.255. |

▾ Allowing Forwarding of Directed Broadcast Packets

| | |
|------------------------------|---|
| Command | ip directed-broadcast [<i>access-list-number</i>] |
| Parameter Description | <i>access-list-number</i> : Access list number, ranging from 1 to 199 and from 1300 to 2699. After an ACL is defined, only directed broadcast packets that match the ACL are forwarded. |
| Command Mode | Interface configuration mode |
| Usage Guide | If the no ip directed-broadcast command is run on an interface, the RGOS software will discard directed broadcast packets received from the network that is directly connected. |

Configuration Example

| | |
|----------------------------|---|
| Configuration Steps | <p>On interface gigabitEthernet 0/1, set the destination address of IP broadcast packets to 0.0.0.0 and enable directed broadcast forwarding.</p> <pre>Ruijie#configure terminal Ruijie(config)#interface gigabitEthernet 0/1 Ruijie(config-if-GigabitEthernet 0/1)# no switchport Ruijie(config-if-GigabitEthernet 0/1)#ip broadcast-address 0.0.0.0 Ruijie(config-if-GigabitEthernet 0/1)#ip directed-broadcast</pre> |
|----------------------------|---|

| | |
|---------------------|---|
| Verification | <p>Run the show ip interface command to check whether the configuration takes effect.</p> <pre>Ruijie#show running-config interface gigabitEthernet 0/1 ip directed-broadcast ip broadcast-address 0.0.0.0</pre> |
|---------------------|---|

1.4.3 Configuring ICMP Forwarding

Configuration Effect

Enable ICMP unreachable messages, ICMP redirection messages, and mask response messages on an interface.

Notes

N/A

Configuration Steps

▾ Enabling ICMP Unreachable Messages

- By default, ICMP unreachable messages are enabled.
- Optional)The **no ip unreachable** command can be used to disable ICMP unreachable messages.
- Perform the configuration in L3 interface configuration mode.

▾ Enabling ICMP Redirection Messages

- By default, ICMP redirection messages are enabled.
- Optional)The **no ip redirects** command can be used to disable ICMP redirection messages.
- Perform the configuration in L3 interface configuration mode.

▾ Enabling ICMP Mask Response Messages

- By default, ICMP mask response messages are enabled.
- Optional)The **no ip mask-reply** command can be used to disable ICMP mask response messages.
- Perform the configuration in L3 interface configuration mode.

▾ Enabling Notifications of Expired TTL

- By default, notifications of expired TTL are enabled.
- (Optional)The **[no]ip ttl-expires enable** command can be used to enable or disable the function.
- Perform the configuration in global configuration mode.

▾ Enabling Returning of Timestamp Reply

- By default, returning of Timestamp Reply is enabled.
- (Optional)The **[no] ip icmp timestamp** command can be used to enable or disable the function.

- Perform the configuration in global configuration mode.

Verification

Run the **show ip interface** command to check whether the configuration takes effect.

Run the **show running-config** command to check whether returning of Timestamp Reply is enabled.

Related Commands

↳ Enabling ICMP Unreachable Messages

| | |
|------------------------------|------------------------------|
| Command | ip unreachable |
| Parameter Description | N/A |
| Command Mode | Interface configuration mode |
| Usage Guide | N/A |

↳ Enabling ICMP Redirection Messages

| | |
|------------------------------|------------------------------|
| Command | ip redirects |
| Parameter Description | N/A |
| Command Mode | Interface configuration mode |
| Usage Guide | N/A |

↳ Enabling ICMP Mask Response Messages

| | |
|------------------------------|------------------------------|
| Command | ip mask-reply |
| Parameter Description | N/A |
| Command Mode | Interface configuration mode |
| Usage Guide | N/A |

↳ Disabling Notifications of Expired TTL

| | |
|------------------------------|---------------------------------|
| Command | no ip ttl-expires enable |
| Parameter Description | N/A |
| Command Mode | Global configuration mode |
| Usage Guide | N/A |

▾ Disabling Returning of Timestamp Reply

| | |
|------------------------------|-----------------------------|
| Command | no ip icmp timestamp |
| Parameter Description | N/A |
| Command Mode | Global configuration mode |
| Usage Guide | N/A |

Configuration Example

| | |
|----------------------------|--|
| Configuration Steps | <p>Enable ICMP unreachable messages, ICMP redirection messages, and mask response messages on interface gigabitEthernet 0/1.</p> <pre>Ruijie#configure terminal Ruijie(config)# no ip ttl-expires enable Ruijie(config)# no ip icmp timestamp Ruijie(config)#interface gigabitEthernet 0/1 Ruijie(config-if-GigabitEthernet 0/1)# no switchport Ruijie(config-if-GigabitEthernet 0/1)# ip unreachable Ruijie(config-if-GigabitEthernet 0/1)# ip redirects Ruijie(config-if-GigabitEthernet 0/1)# ip mask-reply</pre> |
| Verification | <p>Run the show ip interface command to check whether the configuration takes effect.</p> <pre>Ruijie#show running-config include ip ttl-expires enable no ip ttl-expires enable Ruijie#show running-config include ip icmp timestamp no ip icmp timestamp Ruijie#show ip interface gigabitEthernet 0/1 GigabitEthernet 0/1 ICMP mask reply is: ON Send ICMP redirect is: ON Send ICMP unreachable is: ON</pre> |

1.4.4 Configuring the Transmission Rate of ICMP Error Packets

Configuration Effect

Configure the transmission rate of ICMP error packets.

Notes

N/A

Configuration Steps

▾ Configuring the Transmission Rate of ICMP Destination Unreachable Packets Triggered by the DF Bit in the IP Header

- Optional
- Perform the configuration in global configuration mode.

▾ Configuring the Transmission Rate of Other ICMP Error Packets

- Optional
- Perform the configuration in global configuration mode.

Verification

Run the **show running-config** command to check whether the configuration takes effect.

Related Commands

▾ Configuring the Transmission Rate of ICMP Destination Unreachable Packets Triggered by the DF Bit in the IP Header

| | |
|------------------------------|---|
| Command | ip icmp error-interval DF <i>milliseconds</i> [<i>bucket-size</i>] |
| Parameter Description | <i>milliseconds</i> : Refresh cycle of a token bucket. The value range is from 0 to 2,147,483,647 and the default value is 100 milliseconds. When the value is 0, the transmission rate of ICMP error packets is not limited. <i>bucket-size</i> : Number of tokens contained in a token bucket. The value range is from 1 to 200 and the default value is 10. |
| Command Mode | Global configuration mode. |
| Usage Guide | This function limits the transmission rate of ICMP error packets to prevent DoS attacks by using the token bucket algorithm. If an IP packet needs to be fragmented but the DF bit in the header is set to 1, the device sends an ICMP destination unreachable packet (code 4) to the source host. This ICMP error packet is used to discover the path MTU. When there are too many other ICMP error packets, the ICMP destination unreachable packet (code 4) may not be sent. As a result, the path MTU discovery function fails. To avoid this problem, you should limit the transmission rate of ICMP destination unreachable packets and other ICMP error packets respectively. |

| | |
|--|---|
| | It is recommended to set the refresh cycle to integral multiples of 10 milliseconds. If the refresh cycle is set to a value greater than 0 and smaller than 10 milliseconds, the refresh cycle that actually takes effect is 10 milliseconds. For example, if the refresh rate is set to 1 per 5 milliseconds, the refresh rate that actually takes effect is 2 per 10 milliseconds. If the refresh cycle is not integral multiples of 10 milliseconds, the refresh cycle that actually takes effect is automatically converted to integral multiples of 10 milliseconds. For example, if the refresh rate is set to 3 per 15 milliseconds, the refresh rate that actually takes effect is 2 per 10 milliseconds. |
|--|---|

↘ Configuring the Transmission Rate of Other ICMP Error Packets

| | |
|------------------------------|---|
| Command | ip icmp error-interval <i>milliseconds</i> [<i>bucket-size</i>] |
| Parameter Description | <i>milliseconds</i> : Refresh cycle of a token bucket. The value range is 0 to 2,147,483,647, and the default value is 100 (ms). When the value is 0 , the transmission rate of ICMP error packets is not limited. <i>bucket-size</i> : Number of tokens contained in a token bucket. The value range is 1 to 200 and the default value is 10 . |
| Command Mode | Global configuration mode. |
| Usage Guide | This function limits the transmission rate of ICMP error packets to prevent DoS attacks by using the token bucket algorithm. It is recommended to set the refresh cycle to integral multiples of 10 milliseconds. If the refresh cycle is set to a value greater than 0 and smaller than 10 milliseconds, the refresh cycle that actually takes effect is 10 milliseconds. For example, if the refresh rate is set to 1 per 5 milliseconds, the refresh rate that actually takes effect is 2 per 10 milliseconds. If the refresh cycle is not integral multiples of 10 milliseconds, the refresh cycle that actually takes effect is automatically converted to integral multiples of 10 milliseconds. For example, if the refresh rate is set to 3 per 15 milliseconds, the refresh rate that actually takes effect is 2 per 10 milliseconds. |

Configuration Example

| | |
|----------------------------|---|
| Configuration Steps | Set the transmission rate of ICMP destination unreachable packets triggered the DF bit in IP header to 100 packets per second and the transmission rate of other ICMP error packets to 10 packets per second. |
| | <pre>Ruijie(config)# ip icmp error-interval DF 1000 100 Ruijie(config)# ip icmp error-interval 1000 10</pre> |
| Verification | Run the show running-config command to check whether the configuration takes effect. |
| | <pre>Ruijie#show running-config include ip icmp error-interval ip icmp error-interval 1000 10 ip icmp error-interval DF 1000 100</pre> |

1.4.5 Setting the IP MTU

Configuration Effect

Adjust the IP packet MTU.

Notes

N/A

Configuration Steps

- (Optional) When the IP MTU of interconnected interfaces is different on devices in the same physical network segment, set the IP MTU to the same value.
- Perform the configuration in L3 interface configuration mode.

Verification

Run the **show ip interface** command to check whether the configuration takes effect.

Related Commands

▾ Setting the IP MTU

| | |
|---------------------|--|
| Command | ip mtu bytes |
| Parameter | <i>bytes</i> : IP packet MTU. The value range is from 68 to 1,500 bytes. |
| Description | |
| Command Mode | Interface configuration mode |
| Usage Guide | N/A |

Configuration Example

| | |
|----------------------------|---|
| Configuration Steps | Set the IP MTU of interface gigabitEthernet 0/1 to 512 bytes. |
| | <pre>Ruijie#configure terminal Ruijie(config)#interface gigabitEthernet 0/1 Ruijie(config-if-GigabitEthernet 0/1)# no switchport Ruijie(config-if-GigabitEthernet 0/1)#ip mtu 512</pre> |
| Verification | Run the show ip interface command to check whether the configuration takes effect. |
| | <pre>Ruijie# show ip interface gigabitEthernet 0/1 IP interface MTU is: 512</pre> |

1.4.6 Setting the IP TTL

Configuration Effect

Modify the IP TTL value of an interface.

Notes

N/A

Configuration Steps

- Optional
- Perform the configuration in L3 interface configuration mode.

Verification

Run the **show run-config** command to check whether the configuration takes effect.

Related Commands

↘ Setting the IP TTL

| | |
|------------------------------|---|
| Command | <code>ip ttl value</code> |
| Parameter Description | <i>value</i> : TTL value. The value range is from 0 to 255. |
| Command Mode | Global configuration mode. |
| Usage Guide | N/A |

Configuration Example

| | |
|----------------------------|--|
| Configuration Steps | <ul style="list-style-type: none"> ● Set the TTL of unicast packets to 100. |
| | <pre>Ruijie#configure terminal Ruijie(config)#ip ttl 100</pre> |
| Verification | Run the show run-config command to check whether the configuration takes effect. |
| | <pre>Ruijie#show running-config ip ttl 100</pre> |

1.4.7 Configuring an IP Source Route

Configuration Effect

Enable or disable the IP source route function.

Notes

N/A

Configuration Steps

- By default, the IP source route function is enabled.
- Optional) The **no ip source-route** command can be used to disable the IP source route function.

Verification

Run the **show run-config** command to check whether the configuration takes effect.

Related Commands

↘ Configuring an IP Source Route

| | |
|---------------------|----------------------------|
| Command | ip source-route |
| Parameter | N/A |
| Description | |
| Command Mode | Global configuration mode. |
| Usage Guide | N/A |

Configuration Example

| | |
|----------------------------|---|
| Configuration Steps | <ul style="list-style-type: none"> ● Disable the IP source route function. |
| | <pre>Ruijie#configure terminal Ruijie(config)#no ip source-route</pre> |
| Verification | Run the show run-config command to check whether the configuration takes effect. |
| | <pre>Ruijie#show running-config no ip source-route</pre> |

1.4.8 Configuring an IP Address Pool

Configuration Effect

Assign an IP address to a client through PPP negotiation.

Notes

N/A

Configuration Steps

↘ Enabling the IP Address Pool Function

- Optional
- Perform the configuration in global configuration mode.

↘ Creating an IP Address Pool

- Optional
- An IP address pool can be created only after the IP address pool function is enabled. After the IP address pool function is disabled, the created address pool is automatically deleted.
- Perform the configuration in global configuration mode.

↘ Assigning an IP Address to the Peer End through PPP Negotiation

- Optional
- Perform the configuration in L3 interface configuration mode.

Verification

Run the **show run-config** command to check whether the configuration takes effect.

Related Commands

↘ Enabling the IP Address Pool Function

| | |
|------------------------------|--|
| Command | ip address-pool local |
| Parameter Description | N/A |
| Command Mode | Global configuration mode |
| Usage Guide | By default, the IP address pool function is enabled. You can configure an IP address pool to assign an IP address to the peer end through PPP negotiation. To disable the IP address pool function, run the no ip address-pool local command. All IP address pools configured previously will be deleted. |

↘ Creating an IP Address Pool

| | |
|------------------------------|--|
| Command | ip local pool <i>pool-name</i> <i>low-ip-address</i> [<i>high-ip-address</i>] |
| Parameter Description | <i>pool-name</i> : Name of a local IP address pool. default indicates the default address pool name. <i>low-ip-address</i> : Smallest IP address in an IP address pool. <i>high-ip-address</i> : Optional) Largest IP address in an IP address pool. If the largest IP address is not specified, the IP address pool contains only one IP address, that is, <i>low-ip-address</i> . |
| Command Mode | Global configuration mode |
| Usage Guide | The command is used to create one or more IP address pools to assign IP addresses to peer ends through PPP negotiation. |

↘ Assigning an IP Address to the Peer End through PPP Negotiation

| | |
|------------------------------|--|
| Command | peer default ip address { <i>ip-address</i> pool [<i>pool-name</i>]} |
| Parameter Description | <i>ip-address</i> : IP address assigned to the peer end. <i>pool-name</i> : (Optional) Specifies the address pool that assigns IP addresses. If this parameter is not set, IP |

| | |
|---------------------|--|
| | addresses are assigned from the default address pool. |
| Command Mode | Interface configuration mode |
| Usage Guide | <p>If the peer end is not configured with an IP address while the local device is configured with an IP address, you can enable the local device to assign an IP address to the peer end. Run the ip address negotiate command on the peer end and the peer default ip address command on the local device so that the peer end can accept the IP address assigned through PPP negotiation.</p> <p>The peer default ip address command can be configured on only PPP or SLIP interfaces.</p> <p>The peer default ip address pool command is used to assign an IP address to the peer end from an IP address pool. The IP address pool is configured through the ip local pool command.</p> <p>The peer default ip address ip-address command is used to specify an IP address for the peer end. The command cannot be run on virtual template interfaces or asynchronous interfaces.</p> |

Configuration Example

| | |
|----------------------------|---|
| Configuration Steps | <ul style="list-style-type: none"> Assign an IP address from address pool “quark” to the peer end on interface “dialer1”. |
| | <pre>Ruijie#configure terminal Ruijie(config)# ip address-pool local Ruijie(config)# ip local pool quark 172.16.23.2 172.16.23.255 Ruijie(config)# interface dialer 1 Ruijie(config-if-dialer 1)#peer default ip address pool quark</pre> |
| Verification | Run the show run-config command to check whether the configuration takes effect. |
| | <pre>Ruijie#show running-config ip local pool quark 172.16.23.2 172.16.23.255 ! interface dialer 1 peer default ip address pool quark</pre> |

1.5 Monitoring

Displaying

| Description | Command |
|--|---|
| Displays the IP address of an interface. | show ip interface [<i>interface-type</i> <i>interface-number</i> brief] |
| Displays IP packet statistics. | show ip packet statistics [total <i>interface-name</i>] |
| Displays address pool statistics. | show ip pool [<i>pool-name</i>] |

2 Configuring ARP

2.1 Overview

In a local area network (LAN), each IP network device has two addresses: 1) local address. Since the local address is contained in the header of the data link layer (DLL) frame, it is a DLL address. However, it is processed by the MAC sublayer at the DLL and thereby is usually called the MAC address. MAC addresses represent IP network devices on LANs. 2) network address. Network addresses on the Internet represent IP network devices and also indicate the networks where the devices reside.

In a LAN, two IP devices can communicate with each other only after they learn the 48-bit MAC address of each other. The process of obtaining the MAC address based on the IP address is called address resolution. There are two types of address resolution protocols: 1) Address Resolution Protocol (ARP); 2) Proxy ARP. ARP and Proxy ARP are described respectively in RFC 826 and RFC 1027.

ARP is used to bind the MAC address with the IP address. When you enter an IP address, you can learn the corresponding MAC address through ARP. Once the MAC address is obtained, the IP-MAC mapping will be saved to the ARP cache of the network device. With the MAC address, the IP device can encapsulate DLL frames and send them to the LAN. By default, IP and ARP packets on the Ethernet are encapsulated in Ethernet II frames.

Protocols and Standards

- RFC 826: An Ethernet Address Resolution Protocol
- RFC 1027: Using ARP to implement transparent subnet gateways

2.2 Applications

| Application | Description |
|--|---|
| LAN-based ARP | A user learns the MAC addresses of other users in the same network segment through ARP. |
| Proxy ARP-based Transparent Transmission | With Proxy ARP, a user can directly communicate with users in another network without knowing that it exists. |

2.2.1 LAN-based ARP

Scenario

ARP is required in all IPv4 LANs.

- A user needs to learn the MAC addresses of other users through ARP to communicate with them.

Figure 2-1

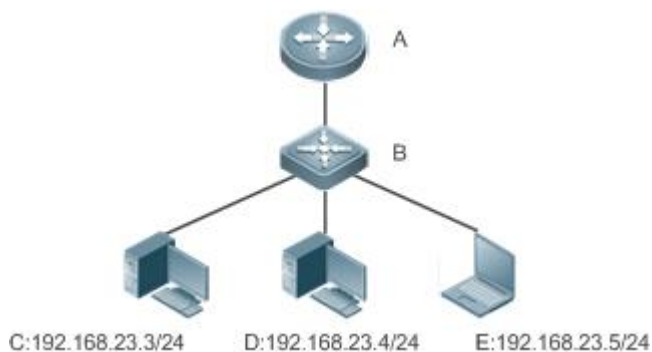

| | |
|----------------|--|
| Remarks | A is a router. B is a switch. It acts as the gateway. C, D, and E are hosts. |
|----------------|--|

Deployment

- Enable ARP in a LAN to implement IP-MAC mapping.

2.2.2 Proxy ARP-based Transparent Transmission

Scenario

Transparent transmission across IPv4 LANs is performed.

- Enable Proxy ARP on the router to achieve direct communication between users in different network segments.

Figure 2-2

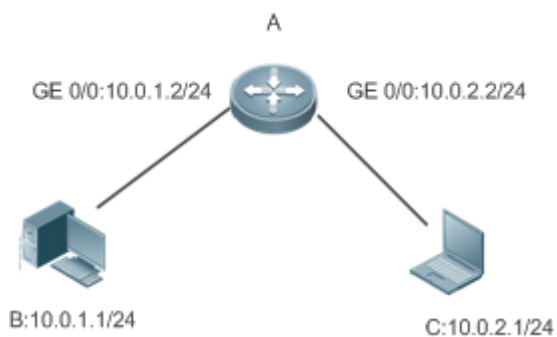

| | |
|----------------|--|
| Remarks | A is a router connecting two LANs. B and C are hosts in different subnets. No default gateway is configured for them. |
|----------------|--|

Deployment

- Enable Proxy ARP on the subnet gateway. After configuration, the gateway can act as a proxy to enable a host without any route information to obtain MAC addresses of IP users in other subnets.

2.3 Features

Overview

| Feature | Description |
|--|---|
| Static ARP | Users can manually specify IP-MAC mapping to prevent the device from learning incorrect ARP entries. |
| ARP Attributes | Users can specify the ARP entry timeout, ARP request retransmission times and interval, and maximum number of unresolved ARP entries. |
| Gratuitous ARP | Gratuitous ARP is used to detect IP address conflicts and enable peripheral devices to update ARP entries. |
| Proxy ARP | A proxy replies to the ARP requests from other devices in different subnets. |
| ARP Trustworthiness Detection | Neighbor Unreachable Detection (NUD) is used to ensure that correct ARP entries are learned. |
| Disabling Dynamic ARP Entry Learning | After dynamic ARP learning is disabled on an interface, the interface does not learn dynamic ARP entries. |

2.3.1 Static ARP

Static ARP entries can be configured manually or assigned by the authentication server. The manually configured ones prevail. Static ARP can prevent the device from learning incorrect ARP entries.

Working Principle

If static ARP entries are configured, the device does not actively update ARP entries and these ARP entries permanently exist.

When the device forwards Layer-3 packets, the static MAC address is encapsulated in the Ethernet header as the destination MAC address.

Related Configuration

↘ Enabling Static ARP

Run the **arp ip-address mac-address type** command in global configuration mode to configure static ARP entries. By default, no static ARP entry is configured. ARP encapsulation supports only the Ethernet II type, which is represented by ARPA.

2.3.2 ARP Attributes

Users can specify the ARP timeout, ARP request retransmission interval and times, maximum number of unresolved ARP entries, maximum number of ARP entries on an interface, and maximum number of ARP entries on a board.

Working Principle

↘ ARP Timeout

The ARP timeout only applies to the dynamically learned IP-MAC mapping. When the ARP entry timeout expires, the device sends a unicast ARP request packet to detect whether the peer end is online. If it receives an ARP reply from the peer end, it does not delete this ARP entry. Otherwise, the device deletes this ARP entry.

When the ARP timeout is set to a smaller value, the mapping table stored in the ARP cache is more accurate but ARP consumes more network bandwidth.

↘ ARP Request Retransmission Interval and Times

The device consecutively sends ARP requests to resolve an IP address to a MAC address. The shorter the retransmission interval is, the faster the resolution is. The more times the ARP request is retransmitted, the more likely the resolution will succeed and the more bandwidth ARP will consume.

↘ Maximum Number of Unresolved ARP Entries

In a LAN, ARP attacks and scanning may cause a large number of unresolved ARP entries generated on the gateway. As a result, the gateway fails to learn the MAC addresses of the users. To prevent such attacks, users can configure the maximum number of unresolved ARP entries.

↘ Maximum Number of ARP Entries on an Interface

Configure the maximum number of ARP entries on a specified interface to prevent ARP entry resource waste.

↘ Maximum Number of ARP Entries on a Board

Configure the maximum number of ARP entries on a specified slot to limit their ARP capabilities and prevent ARP entry resource waste.

Related Configuration

↘ Configuring the ARP Timeout

Run the **arp timeout** *seconds* command in interface configuration mode to configure the ARP timeout. The default timeout is 3,600 seconds. You can change it based on actual situations.

↘ Configuring the ARP Request Retransmission Interval and Times

- Run the **arp retry interval** *seconds* command in global configuration mode to configure the ARP request retransmission interval. The default interval is 1 second. You can change it based on actual situations.
- Run the **arp retry times** *number* command in global configuration mode to configure the ARP request retransmission times. The default number of retransmission times is 5. You can change it based on actual situations.

↘ Configuring the Maximum Number of Unresolved ARP Entries

Run the **arp unresolve** *number* command in global configuration mode to configure the maximum number of unresolved ARP entries. The default value is the maximum number of ARP entries supported by the device. You can change it based on actual situations.

↘ Configuring the Maximum Number of ARP Entries on an Interface

Run the **arp cache interface-limit** *limit* command in interface configuration mode to configure the maximum number of ARP entries learned on an interface. The default number is 0. You can change it based on actual situations. This command also applies to static ARP entries.

2.3.3 Gratuitous ARP

Working Principle

Gratuitous ARP packets are a special type of ARP packets. In a gratuitous ARP packet, the source and destination IP addresses are the IP address of the local device. Gratuitous ARP packets have two purposes:

1. IP address conflict detection. If the device receives a gratuitous packet and finds the IP address in the packet the same as its own IP address, it sends an ARP reply to notify the peer end of the IP address conflict.
2. ARP update. When the MAC address of an interface changes, the device sends a gratuitous ARP packet to notify other devices to update ARP entries.

The device can learn gratuitous ARP packets. After receiving a gratuitous ARP packet, the device checks whether the corresponding dynamic ARP entry exists. If yes, the device updates the ARP entry based on the information carried in the gratuitous ARP packet.

Related Configuration

▾ Enabling Gratuitous ARP

Run the **arp gratuitous-send interval** *seconds* [*number*] command in interface configuration mode to enable gratuitous ARP. This function is disabled on interfaces by default. Generally you need to enable this function on the gateway interface to periodically update the MAC address of the gateway on the downlink devices, which prevents others from faking the gateway.

2.3.4 Proxy ARP

Working Principle

The device enabled with Proxy ARP can help a host without any route information to obtain MAC addresses of IP users in other subnets. For example, if the device receiving an ARP request finds the source IP address in a different network segment from the destination IP address and knows the route to the destination address, the device sends an ARP reply containing its own Ethernet MAC address. This is how Proxy ARP works.

Related Configuration

▾ Enabling Proxy ARP

- Run the **ip proxy-arp** command in interface configuration mode to enable Proxy ARP.
- This function is enabled by default.

2.3.5 ARP Trustworthiness Detection

Working Principle

The **arp trust-monitor enable** command is used to enable anti-ARP spoofing to prevent excessive useless ARP entries from occupying device resources. After ARP trustworthiness detection is enabled on a Layer-3 interface, the device receives ARP request packets from this interface:

1. If the corresponding entry does not exist, the device creates a dynamic ARP entry and performs NUD after 1 to 5 seconds. That is, the device begins to age the newly learned ARP entry and sends a unicast ARP request. If the device receives an ARP update packet from the peer end within the aging time, it stores the entry. If not, it deletes the entry.
2. If the corresponding ARP entry exists, NUD is not performed.
3. If the MAC address in the existing dynamic ARP entry is updated, the device also performs NUD.

Since this function adds a strict confirmation procedure in the ARP learning process, it affects the efficiency of ARP learning.

After this function is disabled, NUD is not required for learning and updating ARP entries.

Related Configuration

▾ Enabling ARP Trustworthiness Detection

Run the **arp trust-monitor enable** command in interface configuration mode to enable ARP trustworthiness detection. This function is disabled by default.

2.3.6 Disabling Dynamic ARP Entry Learning

Working Principle



After dynamic ARP entry learning is disabled on an interface, this interface does not learn dynamic ARP entries.





Related Configuration

▾ Disabling Dynamic ARP Entry Learning

- Dynamic ARP entry learning is enabled on interfaces by default.
- Run the **no arp-learning enable** command in interface configuration mode to disable dynamic ARP entry learning.

2.4 Configuration

| Configuration | Description and Command |
|--|---|
| Enabling Static ARP |  (Optional) It is used to enable static IP-MAC binding. |
| | arp Enables static ARP. |
| Configuring ARP Attributes |  (Optional) It is used to specify the ARP timeout, ARP request retransmission interval and times, maximum number of unresolved ARP entries, maximum number of ARP entries on an interface, and maximum number of ARP entries on a board. |

| Configuration | Description and Command | |
|--|--|---|
| | arp timeout | Configures the ARP timeout. |
| | arp retry interval | Configures the ARP request retransmission interval. |
| | arp unresolve | Configures the maximum number of unresolved ARP entries. |
| | arp cache interface-limit | Configures the maximum number of ARP entries on an interface. |
| Enabling Gratuitous ARP |  (Optional) It is used to detect IP address conflicts and enables peripheral devices to update ARP entries. | |
| | arp gratuitous-send interval | Enables gratuitous ARP. |
| Enabling Proxy ARP |  (Optional) It is used to act as a proxy to reply to ARP requests from the devices in different subnets. | |
| | ip proxy-arp | Enables Proxy ARP. |
| Enabling ARP Trustworthiness Detection |  (Optional) It is used to unicast ARP request packets to ensure that correct ARP entries are learned. | |
| | arp trusted-monitor enable | Enables ARP trustworthiness detection. |
| Disabling Dynamic ARP Learning |  (Optional) It is used to disable dynamic ARP learning on an interface. | |
| | no arp-learning enable | Disables dynamic ARP learning on an interface. |

2.4.1 Enabling Static ARP

Configuration Effect

Users can manually specify IP-MAC mapping to prevent the device from learning incorrect ARP entries.

Notes

After a static ARP entry is configured, the Layer-3 switch learns the physical port corresponding to the MAC address in the static ARP entry before it performs Layer-3 routing.

Configuration Steps

▾ [Configuring Static ARP Entries](#)

- Optional.
- You can configure a static ARP entry to bind the IP address of the uplink device with its MAC address to prevent MAC change caused by ARP attacks.
- Configure static ARP entries in global configuration mode.

Verification

Run the **show running-config** command to check whether the configuration takes effect. Or run the **show arp static** command to check whether a static ARP cache table is created.

Related Commands

Configuring Static ARP Entries

| | |
|------------------------------|---|
| Command | arp <i>ip-address mac-address type</i> |
| Parameter Description | <i>ip-address</i> : Indicates the IP address mapped to a MAC address, which is in four-part dotted-decimal format. <i>mac-address</i> : Indicates the DLL address, consisting of 48 bits. <i>type</i> : Indicates the ARP encapsulation type. For an Ethernet interface, the keyword is arpa . |
| Command Mode | Global configuration mode |
| Usage Guide | The RGOS queries a 48-bit MAC address based on a 32-bit IP address in the ARP cache table. Since most hosts support dynamic ARP resolution, usually the static ARP mapping are not configured. Use the clear arp-cache command to delete the dynamic ARP entries. |

Configuration Example

| Scenario | For the network topology, see Figure 2-1. | | | | | | | | | | | | |
|----------------------------|---|----------|----------------|----------|-----------|------|-----------|----------|--------------|----------|----------------|------|--|
| Configuration Steps | Configure a static ARP entry on B to statically bind the IP address of A with the MAC address. <pre>Ruijie(config)#arp 192.168.23.1 00D0.F822.334B arpa</pre> | | | | | | | | | | | | |
| Verification | Run the show arp static command to display the static ARP entry. <pre>Ruijie(config)#show arp static</pre> <table border="1"> <thead> <tr> <th>Protocol</th> <th>Address</th> <th>Age(min)</th> <th>Hardware</th> <th>Type</th> <th>Interface</th> </tr> </thead> <tbody> <tr> <td>Internet</td> <td>192.168.23.1</td> <td><static></td> <td>00D0.F822.334B</td> <td>arpa</td> <td></td> </tr> </tbody> </table> 1 static arp entries exist. | Protocol | Address | Age(min) | Hardware | Type | Interface | Internet | 192.168.23.1 | <static> | 00D0.F822.334B | arpa | |
| Protocol | Address | Age(min) | Hardware | Type | Interface | | | | | | | | |
| Internet | 192.168.23.1 | <static> | 00D0.F822.334B | arpa | | | | | | | | | |

Common Errors

- The MAC address in static ARP is incorrect.

2.4.2 Configuring ARP Attributes

Configuration Effect

Users can specify the ARP timeout, ARP request retransmission interval and times, maximum number of unresolved ARP entries, maximum number of ARP entries on an interface, and maximum number of ARP entries on a board.

Configuration Steps

Configuring the ARP Timeout

- Optional.
- In a LAN, if a user goes online/offline frequently, it is recommended to set the ARP timeout small to delete invalid ARP entries as soon as possible.
- Configure the ARP timeout in interface configuration mode.

▾ **Configuring the ARP Request Retransmission Interval and Times**

- Optional.
- If the network resources are insufficient, it is recommended to set the ARP request retransmission interval great and the retransmission times small to reduce the consumption of network bandwidths.
- Configure the ARP request retransmission interval and times in global configuration mode.

▾ **Configuring the Maximum Number of Unresolved ARP Entries**

- Optional.
- If the network resources are insufficient, it is recommended to set the maximum number of unresolved ARP entries small to reduce the consumption of network bandwidths.
- Configure the maximum number of unresolved ARP entries in global configuration mode.

▾ **Configuring the Maximum Number of ARP Entries on an Interface**

- Optional.
- Configure the maximum number of ARP entries on an interface in interface configuration mode.

▾ **Configuring the Maximum Number of ARP Entries on a Board**

- Optional.
- Configure the maximum number of ARP entries on a board in global configuration mode.

Verification

Run the **show arp timeout** command to display the timeouts of all interfaces.

Run the **show running-config** command to display the ARP request retransmission interval and times, maximum number of unresolved ARP entries, maximum number of ARP entries on an interface, and maximum number of ARP entries on a board.

Related Commands

▾ **Configuring the ARP Timeout**

| | |
|---------------------|---|
| Command | arp timeout <i>seconds</i> |
| Parameter | <i>seconds</i> : Indicates the timeout in seconds, ranging from 0 to 2,147,483. The default value is 3,600. |
| Description | |
| Command Mode | Interface configuration mode |
| Usage Guide | The ARP timeout only applies to the dynamically learned IP-MAC mapping. When the ARP timeout is set to |

| | |
|--|--|
| | a smaller value, the mapping table stored in the ARP cache is more accurate but ARP consumes more network bandwidth. Unless otherwise specified, do not configure the ARP timeout. |
|--|--|

↘ Configuring the ARP Request Retransmission Interval and Times

| | |
|------------------------------|--|
| Command | arp retry interval <i>seconds</i> |
| Parameter Description | <i>seconds</i> : Indicates the ARP request retransmission interval in seconds, ranging from 1 to 3,600. The default value is 1. |
| Command Mode | Global configuration mode |
| Usage Guide | If a device frequently sends ARP requests, affecting network performance, you can set the ARP request retransmission interval longer. Ensure that this interval does not exceed the ARP timeout. |

↘ Configuring the Maximum Number of Unresolved ARP Entries

| | |
|------------------------------|--|
| Command | arp unresolve <i>number</i> |
| Parameter Description | <i>number</i> : Indicates the maximum number of unresolved ARP entries, ranging from 1 to 8,192. The default value is 8,192. |
| Command Mode | Global configuration mode |
| Usage Guide | If a large number of unresolved entries exist in the ARP cache table and remain in the table after a while, it is recommended to use this command to limit the number of unresolved ARP entries. |

↘ Configuring the Maximum Number of ARP Entries on an Interface

| | |
|------------------------------|--|
| Command | arp cache interface-limit <i>limit</i> |
| Parameter Description | <i>limit</i> : Indicates the maximum number of ARP entries that can be learned on an interface, including configured ARP entries and dynamically learned ARP entries. The value ranges from 0 to the ARP entry capacity supported by the device. 0 indicates no limit on this number. |
| Command Mode | Interface configuration mode |
| Usage Guide | Limiting the number of ARP entries on an interface can prevent malicious ARP attacks from generating excessive ARP entries on the device and occupying entry resources. The configured value must be equal to or greater than the number of the ARP entries learned by the interface. Otherwise, the configuration does not take effect. The configuration is subject to the ARP entry capacity supported by the device. |

Configuration Example

| | |
|----------------------------|--|
| Scenario | For the network topology, see Figure 2-1. |
| Configuration Steps | <ul style="list-style-type: none"> ● Set the ARP timeout to 60 seconds on port GigabitEthernet 0/1. ● Set the maximum number of learned ARP entries to 300 on port GigabitEthernet 0/1. ● Set the ARP request retransmission interval to 3 seconds. ● Set the ARP request retransmission times to 4. ● Set the maximum number of unresolved ARP entries to 4,096. |

| | |
|---------------------|--|
| | <pre>Ruijie(config)#interface gigabitEthernet 0/1 Ruijie(config-if-GigabitEthernet 0/1)#arp timeout 60 Ruijie(config-if-GigabitEthernet 0/1)#arp cache interface-limit 300 Ruijie(config-if-GigabitEthernet 0/1)#exit Ruijie(config)#arp retry interval 3 Ruijie(config)#arp retry times 4 Ruijie(config)#arp unresolve 4096</pre> |
| Verification | <ul style="list-style-type: none"> ● Run the show arp timeout command to display the timeout of the interface. ● Run the show running-config command to display the ARP request retransmission interval and times, maximum number of unresolved ARP entries, maximum number of ARP entries on the interface, and maximum number of ARP entries on the board. |
| | <pre>Ruijie#show arp timeout Interface arp timeout(sec) ----- GigabitEthernet 0/1 60 GigabitEthernet 0/2 3600 GigabitEthernet 0/4 3600 GigabitEthernet 0/5 3600 GigabitEthernet 0/7 3600 VLAN 100 3600 VLAN 111 3600 Mgmt 0 3600 Ruijie(config)# show running-config arp unresolve 4096 arp retry times 4 arp retry interval 3 ! interface GigabitEthernet 0/1 arp cache interface-limit 300</pre> |

2.4.3 Enabling Gratuitous ARP

Configuration Effect

The interface periodically sends gratuitous ARP packets.

Configuration Steps

- Optional.
- When a switch acts as the gateway, enable gratuitous ARP on an interface to prevent other users from learning incorrect gateway MAC address in case of ARP spoofing.
- Enable gratuitous ARP in interface configuration mode.

Verification

Run the **show running-config interface <name>** command to check whether the configuration is successful.

Related Commands

↳ Enabling Gratuitous ARP

| | |
|------------------------------|---|
| Command | arp gratuitous-send interval <i>seconds</i> [<i>number</i>] |
| Parameter Description | <i>seconds</i> : Indicates the interval for sending a gratuitous ARP request. The unit is second. The value ranges from 1 to 3,600. <i>number</i> : Indicates the number of gratuitous ARP requests that are sent. The default value is 1. The value ranges from 1 to 100. |
| Command Mode | Interface configuration mode |
| Usage Guide | If a network interface of a device acts as the gateway for downstream devices but a downstream device pretends to be the gateway, enable gratuitous ARP on the interface to advertise itself as the real gateway. |

Configuration Example

| | |
|----------------------------|--|
| Scenario | For the network topology, see Figure 2-1. |
| Configuration Steps | Configure the GigabitEthernet 0/0 interface to send a gratuitous ARP packet every 5 seconds. |
| | <pre>Ruijie(config-if-GigabitEthernet 0/0)#arp gratuitous-send interval 5</pre> |
| Verification | Run the show running-config interface command to check whether the configuration takes effect. |
| | <pre>Ruijie#sh running-config interface gigabitEthernet 0/0 Building configuration... Current configuration : 127 bytes !</pre> |

```
interface GigabitEthernet 0/0
 duplex auto
 speed auto
 ip address 30.1.1.1 255.255.255.0
 arp gratuitous-send interval 5
```

2.4.4 Enabling Proxy ARP

Configuration Effect

The device acts as a proxy to reply to ARP request packets from other users.

Notes

By default, Proxy ARP is disabled on Layer-3 switches while enabled on routers.

Configuration Steps

- Optional.
- If a user without any route information needs to obtain the MAC addresses of the IP users in other subnets, enable Proxy ARP on the device so that the device can act as a proxy to send ARP replies.
- Enable Proxy ARP in interface configuration mode.

Verification

Run the **show ip interface <name>** command to check whether the configuration takes effect.

Related Commands

↘ Enabling Proxy ARP

| | |
|---------------------|------------------------------|
| Command | ip proxy-arp |
| Parameter | N/A |
| Description | |
| Command Mode | Interface configuration mode |
| Usage Guide | N/A |

Configuration Example

| | |
|----------------------------|--|
| Scenario | For the network topology, see Figure 2-1. |
| Configuration Steps | Enable Proxy ARP on port GigabitEthernet 0/0 . |
| | Ruijie(config-if-GigabitEthernet 0/0)#ip proxy-arp |

| Verification | Run the show ip interface command to check whether the configuration takes effect. |
|--------------|--|
| | <pre> Ruijie#show ip interface gigabitEthernet 0/0 GigabitEthernet 0/0 IP interface state is: DOWN IP interface type is: BROADCAST IP interface MTU is: 1500 IP address is: No address configured IP address negotiate is: OFF Forward direct-broadcast is: OFF ICMP mask reply is: ON Send ICMP redirect is: ON Send ICMP unreachable is: ON DHCP relay is: OFF Fast switch is: ON Help address is: 0.0.0.0 Proxy ARP is: ON ARP packet input number: 0 Request packet : 0 Reply packet : 0 Unknown packet : 0 TTL invalid packet number: 0 ICMP packet input number: 0 Echo request : 0 Echo reply : 0 Unreachable : 0 Source quench : 0 Routing redirect : 0 </pre> |

2.4.5 Enabling ARP Trustworthiness Detection

Configuration Effect

Enable ARP trustworthiness detection. If the device receiving an ARP request packet fails to find the corresponding entry, it performs NUD. If the MAC address in the existing dynamic ARP entry is updated, the device immediately performs NUD to prevent ARP attacks.

Notes

Since this function adds a strict confirmation procedure in the ARP learning process, it affects the efficiency of ARP learning.

Configuration Steps

- Optional.
- If there is a need for learning ARP entries, enable ARP trustworthiness detection on the device. If the device receiving an ARP request packet fails to find the corresponding entry, it needs to send a unicast ARP request packet to check whether the peer end exists. If yes, the device learns the ARP entry. If not, the device does not learn the ARP entry. If the MAC address in the ARP entry changes, the device will immediately perform NUD to prevent ARP spoofing.
- Enable ARP trustworthiness detection in interface configuration mode.

Verification

Run the **show running-config interface** <name> command to check whether the configuration take effect

Related Commands

▾ Enabling ARP Trustworthiness Detection

| | |
|------------------------------|--|
| Command | arp trust-monitor enable |
| Parameter Description | N/A |
| Command Mode | Interface configuration mode |
| Usage Guide | <p>❗ Enable this function. If the corresponding ARP entry exists and the MAC address is not updated, the device does not perform NUD.</p> <p>❗ Enable this function. If the MAC address of the existing dynamic ARP entry is updated, the device immediately performs NUD.</p> <p>❗ After this function is disabled, the device does not perform NUD for learning or updating ARP entries.</p> |

Configuration Example

| | |
|----------------------------|---|
| Scenario | For the network topology, see Figure 2-1. |
| Configuration Steps | Enable ARP trustworthiness detection on port GigabitEthernet 0/0. |
| | <pre>Ruijie(config-if-GigabitEthernet 0/0)#arp trust-monitor enable</pre> |
| Verification | Run the show running-config interface command to check whether the configuration takes effect. |

```

Ruijie#show running-config interface gigabitEthernet 0/0

Building configuration...

Current configuration : 184 bytes
!
interface GigabitEthernet 0/0
 duplex auto
 speed auto
 ip address 30.1.1.1 255.255.255.0
 arp trust-monitor enable

```

2.4.6 Disabling Dynamic ARP Learning

Configuration Effect

After dynamic ARP learning is disabled on an interface, the interface does not learn dynamic ARP entries.

Configuration Steps

- Optional.
- Enable dynamic ARP learning in interface configuration mode.

Verification

Run the **show running-config interface <name>** command to check whether the configuration takes effect.

Related Commands

▾ Disabling Dynamic ARP Learning

| | |
|------------------------------|--|
| Command | no arp-learning enable |
| Parameter Description | N/A |
| Command Mode | Interface configuration mode |
| Usage Guide | If the device has learned the dynamic ARP entries and converted the ARP entries into static ARP entries through Web, disable dynamic ARP learning. Otherwise, enable dynamic ARP learning. After this function is enabled, users can convert dynamic ARP entries into static ARP entries through Web. Users can also use the clear arp command to clear ARP entries to deny a user Internet access. If the clear arp command is not configured, dynamic ARP entries will be cleared when the timeout expires. After the dynamic ARP learning function is disabled on an interface, the any IP ARP and ARP trustworthiness detection functions will not work. |

Configuration Example

| | |
|----------------------------|---|
| Scenario | For the network topology, see Figure 2-1. |
| Configuration Steps | Disable dynamic ARP entry learning on port GigabitEthernet 0/0. |
| | <pre>Ruijie(config-if-GigabitEthernet 0/0)#no arp-learning enable</pre> |
| Verification | Run the show running-config interface command to check whether the configuration takes effect. |
| | <pre>Ruijie#sh running-config interface gigabitEthernet 0/0 Building configuration... Current configuration : 127 bytes ! interface GigabitEthernet 0/0 duplex auto speed auto ip address 30.1.1.1 255.255.255.0 no arp-learning enable</pre> |

2.5 Monitoring

Clearing

 Running the **clear** commands may lose vital information and thus interrupt services.

| Description | Command |
|--|------------------------|
| Clears dynamic ARP entries. In gateway authentication mode, dynamic ARP entries in authentication VLANs are not cleared. | clear arp-cache |

Displaying

| Description | Command |
|--|-------------------------|
| Displays the ARP table. | show ip arp |
| Displays the ARP entry counter. | show arp counter |
| Displays the timeout of dynamic ARP entries. | show arp timeout |

Debugging

 System resources are occupied when debugging information is output. Therefore, disable the debugging switch immediately after use.

| Description | Command |
|--|------------------------|
| Debugs ARP packet sending and receiving. | debug arp |
| Debugs the creation and deletion of ARP entries. | debug arp event |

3 Configuring IPv6

3.1 Overview

As the Internet develops rapidly and IPv4 address space is becoming exhausted, IPv4 limitations become more and more obvious. At present, many researches and practices on Internet Protocol Next Generation (IPng) have been conducted. The IPng working group of the Internet Engineering Task Force (IETF) has formulated an IPng protocol named IP Version 6 (IPv6), which is described in RFC 2460.

Main Features

↳ Larger Address Space

Compared with 32 bits in an IPv4 address, the length of an IPv6 address is extended to 128 bits. Therefore, the address space has approximately 2^{128} addresses. IPv6 adopts a hierarchical address allocation mode to support address allocation of multiple subnets from the Internet core network to intranet subnet.

↳ Simpler Packet Header Format

Since the design principle of the IPv6 packet header is to minimize the overhead of the packet header, some non-key fields and optional fields are removed from the packet header to the extended packet header. Therefore, although the length of an IPv6 address is four times of that of an IPv4 address, the IPv6 packet header is only two times of the IPv4 packet header. The IPv6 packet header makes device forwarding more efficient. For example, with no checksum in the IPv6 packet header, the IPv6 device does not need to process fragments (fragmentation is completed by the initiator).

↳ Efficient Hierarchical Addressing and Routing Structure

IPv6 uses a convergence mechanism and defines a flexible hierarchical addressing and routing structure. Multiple networks at the same layer are represented as a uniform network prefix on the upstream device, greatly reducing routing entries maintained by the device and routing and storage overheads of the device.

↳ Easy Management: Plug and Play (PnP)

IPv6 provides automatic discovery and auto-configuration functions to simplify management and maintenance of network nodes. For example, Neighbor Discovery (ND), MTU Discovery, Router Advertisement (RA), Router Solicitation (RS), and auto-configuration technologies provide related services for PnP. Particularly, IPv6 offers two types of auto-configuration: stateful auto-configuration and stateless auto-configuration. In IPv4, Dynamic Host Configuration Protocol (DHCP) realizes auto-configuration of the host IP address and related parameters. IPv6 inherits this auto-configuration service from IPv4 and called it stateful auto-configuration (see DHCPv6). Besides, IPv6 also offers the stateless auto-configuration service. During stateless auto-configuration, a host automatically obtains the local address of the link, address prefix of the local device, and other related configurations.

↳ Security

As an optional extension protocol of IPv4, Internet Protocol Security (IPSec) is a part of IPv6 to provide security for IPv6 packets. At present, IPv6 provides two mechanisms: Authentication Header (AH) and Encapsulated Security Payload (ESP). AH provides data integrity and authenticates IP packet sources to ensure that the packets originate from the nodes identified by the source addresses. ESP provides data encryption to realize end-to-end encryption.

↘ Better QoS Support

A new field in the IPv6 packet header defines how to identify and process data streams. The Flow Label field in the IPv6 packet header is used to authenticate a data flow. Using this field, IPv6 allows users to propose requirements on the communication quality. , A device can identify all packets belonging to a specific data stream based on this field and process these packets according to user requirements.

↘ New Protocol for Neighboring Node Interaction

IPv6 Neighbor Discovery Protocol (NDP) uses a series of Internet Control Message Protocol Version 6 (ICMPv6) packets to implement interactive management of neighboring nodes (nodes on the same link). IPv6 uses NDP packets and efficient multicast/unicast ND packets instead of broadcast-based Address Resolution Protocol (ARP) and Control Message Protocol Version 4 (ICMPv4) router discovery packets.

↘ Extensibility

With strong extensibility, IPv6 features can be added to the extended packet header following the IPv6 packet header. Unlike IPv4, the IPv6 packet header can support at most 40 bytes of options. For an IPv6 packet, the length of the extended packet header is restricted only by the maximum number of bytes in the packet.

Protocols and Standards

- RFC 4291 - IP Version 6 Addressing Architecture
- RFC 2460 - Internet Protocol, Version 6 (IPv6) Specification
- RFC 4443 - Internet Control Message Protocol (ICMPv6) for the Internet Protocol Version 6 (IPv6) Specification
- RFC 4861 - Neighbor Discovery for IP version 6 (IPv6)
- RFC 4862 - IPv6 Stateless Address Auto-configuration
- RFC 5059 - Deprecation of Type 0 Routing Headers in IPv6

3.2 Applications

| Application | Description |
|---|---|
| Communication Based on IPv6 Addresses | Two PCs communicate with each other using IPv6 addresses. |

3.2.1 Communication Based on IPv6 Addresses

Scenario

As shown in Figure 3-1, Host 1 and Host 2 communicate with each other using IPv6 addresses.

Figure 3-1

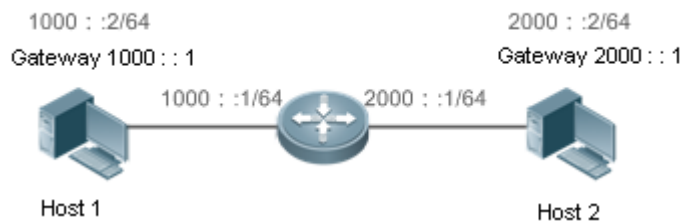

Deployment

Hosts can use the stateless address auto-configuration or DHCPv6 address assignment mode. After addresses are configured, hosts can communicate with each other using IPv6 addresses.

3.3 Features

Overview

| Feature | Description |
|---|---|
| IPv6 Address Format | The IPv6 address format makes IPv6 have a larger address space and flexible representation approach. |
| IPv6 Address Type | IPv6 identifies network applications based on addresses. |
| IPv6 Packet Header Format | IPv6 simplifies the fixed and extended packet headers to improve the data packet processing and forwarding efficiency of the device. |
| IPv6 PMTUD | A host dynamically discovers and adjusts the MTU size on the data Tx path, saving router resources and improving IPv6 network efficiency. |
| IPv6 Neighbor Discovery | ND functions include router discovery, prefix discovery, parameter discovery, address auto-configuration, address resolution (like ARP), next-hop determination, Neighbor Unreachability Detection (NUD), Duplicate Address Detection (DAD), and redirection. |
| IPv6 Source Routing | This feature is used to specify the intermediate nodes that a packet passes through along the path to the destination address. It is similar to the IPv4 loose source routing option and loose record routing option. |
| Restricting the Sending Rate of ICMPv6 Error Messages | This feature prevents DoS attacks. |
| IPv6 HOP-LIMIT | This feature prevents useless unicast packets from being unlimitedly transmitted on the network and wasting network bandwidth. |

3.3.1 IPv6 Address Format

An IPv6 address is represented in the X:X:X:X:X:X:X:X format, where X is a 4-digit hexadecimal integer (16 bits). Each address consists of 8 integers, with a total of 128 bits (each integer contains 4 hexadecimal digits and each digit contains four bits). The following are three valid IPv6 addresses:

```
2001:ABCD:1234:5678:AAAA:BBBB:1200:2100
```

```
800:0:0:0:0:0:0:1
```

```
1080:0:0:0:8:800:200C:417A
```

These integers are hexadecimal, where A to F represent 10 to 15. Each integer in the address must be represented, except the leading zeros in each integer. If an IPv6 address contains a string of zeros (as shown in the second and third examples above), a double colon (::) can be used to represent these zeros. That is, 800:0:0:0:0:0:0:1 can be represented as 800::1.

A double colon indicates that this address can be extended to a complete 128-bit address. In this approach, only when the 16-bit integers are all 0s, can they can be replaced with a double colon. A double colon can exist once in an IPv6 address.

In IPv4/IPv6 mixed environment, an address has a mixed representation. In an IPv6 address, the least significant 32 bits can be used to represent an IPv4 address. This IPv6 address can be represented in a mixed manner, that is, X:X:X:X:X:d.d.d.d, where X is a hexadecimal integer and d is a 8-bit decimal integer. For example, 0:0:0:0:0:192.168.20.1 is a valid IPv6 address. It can be abbreviated to ::192.168.20.1. Typical applications are IPv4-compatible IPv6 addresses and IPv4-mapped IPv6 addresses. If the first 96 bits are 0 in an IPv4-compatible IPv6 address, this address can be represented as ::A.B.C.D, e.g., ::1.1.1.1. IPv4-compatible addresses have been abolished at present. IPv4-mapped IPv6 addresses are represented as ::FFFF:A.B.C.D to represent IPv4 addresses as IPv6 addresses. For example, IPv4 address 1.1.1.1 mapped to an IPv6 address is represented as ::FFFF:1.1.1.1.

Since an IPv6 address is divided into two parts: subnet prefix and interface ID, it can be represented as an address with an additional value according to an address allocation method like Classless Inter-Domain Routing (CIDR). The additional value indicates how many bits (subnet prefix) in the address represent the network part. That is, the IPv6 node address contains the prefix length. The prefix length is separated from the IPv6 address by a slash. For example, in 12AB::CD30:0:0:0:0/60, the prefix length used for routing is 60 bits.

[Related Configuration](#)

📄 [Configuring an IPv6 Address](#)

- No IPv6 address is configured on interfaces by default.
- Run the **ipv6 address** command to configure an IPv6 address on an interface.
- After configuration, a host can communicate with others using the configured IPv6 address based on DAD.

3.3.2 IPv6 Address Type

RFC 4291 defines three types of IPv6 addresses:

- Unicast address: ID of a single interface. Packets destined to a unicast address are sent to the interface identified by this address.

- Multicast address: ID of an interface group (the interfaces generally belong to different nodes). Packets destined to a multicast address are sent to all interfaces included in this address.
- Anycast address: ID of an interface group. Packets destined to an anycast address are sent to one interface included in this address (the nearest interface according to the routing protocol).

 IPv6 does not define broadcast addresses.

These three types of addresses are described as follows:

 **Unicast Addresses**

Unicast addresses fall into five types: unspecified address, loopback address, link-local address, site-local address, and global unicast address. At present, site-local addresses have been abolished. Except unspecified, loopback, and link-local addresses, all other addresses are global unicast addresses.

- Unspecified address

The unspecified address is 0:0:0:0:0:0:0:0, which is usually abbreviated to ::. It has two general purposes:

1. If a host has no unicast address when started, it uses the unspecified address as the source address to send an RS packet to obtain prefix information from the gateway and thereby generate a unicast address.
2. When an IPv6 address is configured for a host, the device detects whether the address conflicts with addresses of other hosts in the same network segment and uses the unspecified address as the source address to send a Neighbor Solicitation (NS) packet (similar to a free ARP packet).

- Loopback address

The loopback address is 0:0:0:0:0:0:0:1, which is usually abbreviated to ::1. Similar to IPv4 address 127.0.0.1, the loopback address is generally used by a node to send itself packets.

- Link-local address

The format of a link-local address is as follows:

Figure 3-2



The link-local address is used on a single network link to assign IDs to hosts. The address identified by the first 10 bits in the prefix is the link-local address. A device never forwards packets in which the source or destination address contains the link-local address. The intermediate 54 bits in the address are all 0s. The last 64 bits represent the interface ID, which allows a single network to connect $2^{64}-1$ hosts.

- Site-local address

The format of a site-local address is as follows:

Figure 3-3

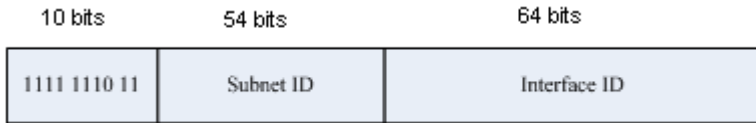

A site-local address is used to transmit data within a site. A device never forwards packets in which the source or destination address contains the site-local address to the Internet. That is, these packets can be forwarded only within the site. A site can be assumed as an enterprise's local area network (LAN). Such addresses are similar to IPv4 private addresses such as 192.168.0.0/16. RFC 3879 has abolished site-local addresses. New addresses do not support the first 10 bits as the prefix and are all regarded as global unicast addresses. Existing addresses can continue to use this prefix.

- Global unicast address

The format of a global unicast address is as follows:

Figure 3-4

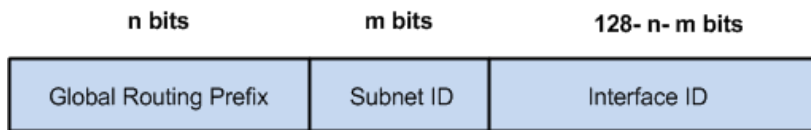

Among global unicast addresses, there is a type of IPv4-embedded IPv6 addresses, including IPv4-compatible IPv6 addresses and IPv4-mapped IPv6 addresses. They are used for interconnection between IPv4 nodes and IPv6 nodes.

The format of an IPv4-compatible IPv6 address is as follows:

Figure 3-5

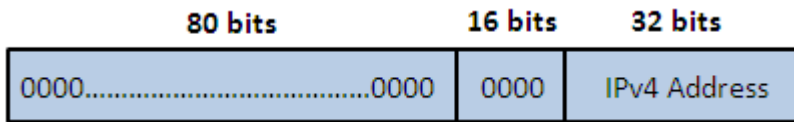

The format of an IPv4-mapped IPv6 address is as follows:

Figure 3-6

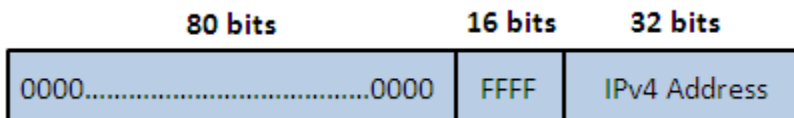

IPv4-compatible IPv6 addresses are mainly used on automatic tunnels. Nodes on automatic tunnels support both IPv4 and IPv6. Using these addresses, IPv4 devices transmit IPv6 packets over tunnels. At present, IPv4-compatible IPv6 addresses have been abolished. IPv4-mapped IPv6 addresses are used by IPv6 nodes to access IPv4-only nodes. For example, if the IPv6 application on an IPv4/IPv6 host requests to resolve the name of an IPv4-only host, the name server dynamically generates an IPv4-mapped IPv6 address and returns it to the IPv6 application.

➤ **Multicast Addresses**

The format of an IPv6 multicast address is as follows:

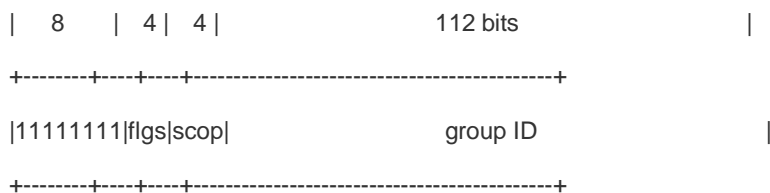

The first byte in the address is all 1s, representing a multicast address.

- Flag field

The flag field consists of four bits. Currently only the fourth bit is specified to indicate whether this address is a known multicast address assigned by the Internet Assigned Numbers Authority (IANA) or a temporary multicast address in a certain scenario. If the flag bit is 0, this address is a known multicast address. If the flag bit is 1, this address is a temporary multicast address. The remaining three flag bits are reserved for future use.

- Scope field

The scope field consists of four bits to indicate the multicast range. That is, a multicast group includes the local node, local link, local site, and any node in the IPv6 global address space.

- Group ID field

The group ID consists of 112 bits to identify a multicast group. A multicast ID can represent different groups based on the flag and scope fields.

IPv6 multicast addresses are prefixed with FF00::/8. One IPv6 multicast address usually identifies interfaces on a series of different nodes. After a packet is sent to a multicast address, the packet is then forwarded to the interfaces on each node identified by this multicast address. For a node (host or device), you must add the following multicast addresses:

1. Multicast address for all nodes on the local link, that is, FF02::1
2. Solicited-node multicast address, prefixed with FF02:0:0:0:1:FF00:0000/104

If the node is a device, it also has to be added to the multicast address of all devices on the local link, that is, FF02::2.

The solicited-node multicast address corresponds to the IPv6 unicast and anycast address. You must add a corresponding solicited-node multicast address for each configured unicast and anycast address of an IPv6 node. The solicited-node multicast address is prefixed with FF02:0:0:0:1:FF00:0000/104. The remaining 24 bits are composed of the least significant 24 bits of the unicast or anycast address. For example, if the unicast address is FE80::2AA:FF:FE21:1234, the solicited-node multicast address is FF02::1:FF21:1234.

The solicited-node multicast address is usually used in NS packets. Its address format is as follows:

Figure 3-7

IPv6 Unicast and Anycast Address

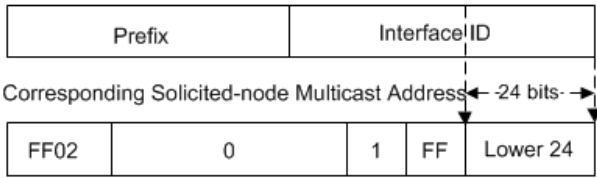

↘ Anycast Addresses

Similar to a multicast address, an anycast address can also be shared by multiple nodes. The difference is that only one node in the anycast address receives data packets while all nodes included in the multicast address receive data packets. Since anycast addresses are allocated to the normal IPv6 unicast address space, they have the same formats with unicast addresses. Every member in an anycast address must be configured explicitly for easier recognition.

! Anycast addresses can be allocated only to devices and cannot be used as source addresses of packets.

RFC 2373 redefines an anycast address called subnet-router anycast address. Figure 3-8 shows the format of a subnet-router anycast address. Such an address consists of the subnet prefix and a series of 0s (interface ID).

The subnet prefix identifies a specified link (subnet). Packets destined to the subnet-router anycast address will be forwarded to a device on this subnet. A subnet-router anycast address is usually used by the application on a node to communicate with a device on a remote subnet.

Figure 3-8

Format of a Subnet-router Anycast Address

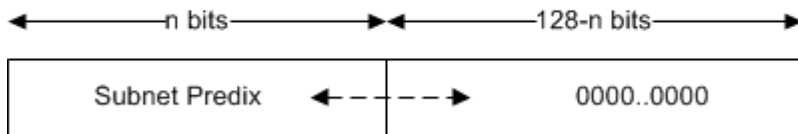

Related Configuration

↘ Configuring an IPv6 Address

- No IPv6 address is configured on interfaces by default.
- Run the **ipv6 address** command to configure the IPv6 unicast address and anycast address of an interface.
- After an interface goes up, it will automatically join the corresponding multicast group.

3.3.3 IPv6 Packet Header Format

Figure 3-9 shows the format of the IPv6 packet header.

Figure 3-9

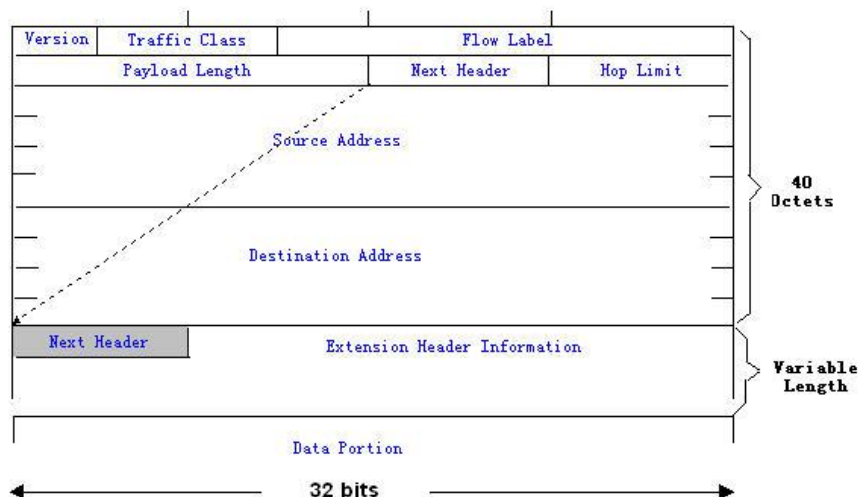

The IPv4 packet header is in unit of four bytes. The IPv6 packet header consists of 40 bytes, in unit of eight bytes. The IPv6 packet header has the following fields:

- Version

This field consists of 4 bits. In an IPv6 address, this field must be 6.

- Traffic Class

This field consists of 8 bits. This field indicates the service provided by this packet, similar to the TOS field in an IPv4 address.

- Flow Label

This field consists of 20 bits to identify packets belonging to the same service flow. One node can act as the Tx source of multiple service flows. The flow label and source address uniquely identify one service flow.

- Payload Length

This field consists of 16 bits, including the packet payload length and the length of IPv6 extended options (if available). That is, it includes the IPv6 packet length except the IPv6 packet header.

- Next Header

This field indicates the protocol type in the header field following the IPv6 packet header. Similar to the Protocol field in the IPv4 address header, the Next Header field is used to indicate whether the upper layer uses TCP or UDP. It can also be used to indicate existence of the IPv6 extension header.

- Hop Limit

This field consists of 8 bits. Every time a device forwards a packet, the field value reduced by 1. If the field value reaches 0, this packet will be discarded. It is similar to the Lifetime field in the IPv4 packet header.

- Source Address

This field consists of 128 bits and indicates the sender address in an IPv6 packet.

- Destination Address

This field consists of 128 bits and indicates the receiver address in an IPv6 packet.

At present, IPv6 defines the following extension headers:

- Hop-By-Hop Options

This extension header must follow the IPv6 packet header. It consists of option data to be checked on each node along the path.

- Routing Options (Type 0 routing header)

This extension header indicates the nodes that a packet passes through from the source address to the destination address. It consists of the address list of the passerby nodes. The initial destination address in the IPv6 packet header is the first address among the addresses in the routing header, but not the final destination address of the packet. After the node corresponding to the destination address in the IPv6 packet header receives a packet, it processes the IPv6 packet header and routing header, and sends the packet to the second address, the third address, and so on in the routing header list till the packet reaches the final destination address.

- Fragment

The source node uses this extension header to fragment the packets of which the length exceeds the path MTU (PMTU).

- Destination Options

This extension header replaces the option fields of IPv4. At present, the Destination Options field can only be filled with integral multiples of 64 bits (eight bytes) if required. This extension header can be used to carry information to be checked by the destination node.

- Upper-layer header

This extension header indicates the protocol used at the upper layer, such as TCP (6) and UDP (17).

Another two extension headers AH and ESP will be described in the *Configuring IPsec*.

3.3.4 IPv6 PMTUD

Similar to IPv4 Path MTU Discovery (PMTUD), IPv6 PMTUD allows a host to dynamically discover and adjust the MTU size on the data Tx path. If the length of a data packet to be sent by a host is greater than the PMTU, the host performs packet fragmentation on its own. In this manner, the IPv6 device does not need to perform fragmentation, saving device resources and improving the IPv6 network efficiency.

Figure 3-10

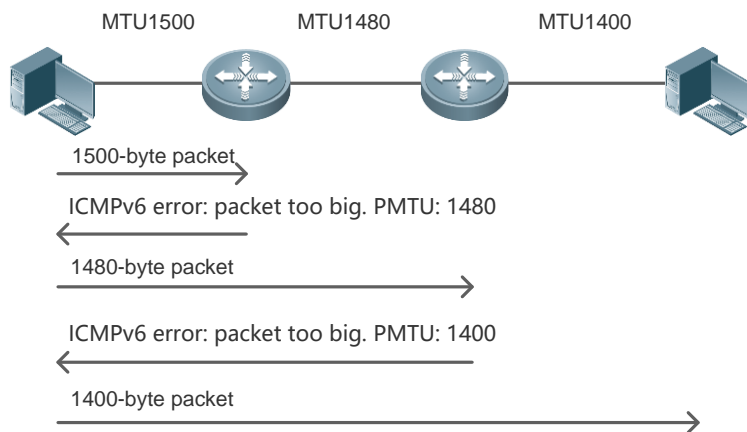

As shown in Figure 3-10, if the length of a packet to be sent by the host is greater than the PMTU, the router discards this packet and sends an ICMPv6 Packet Too Big message containing its PMTU to the host. The host then fragments the packet based on the new PMTU. In this manner, the router does not need to perform fragmentation, saving router resources and improving the IPv6 network efficiency.

Related Configuration

Configuring the IPv6 MTU of an Interface

- The default IPv6 MTU is 1500 on an Ethernet interface.
- Run the `ipv6 mtu` command to modify the IPv6 MTU of an interface.

3.3.5 IPv6 Neighbor Discovery

NDP is a basic part of IPv6. Its main functions include router discovery, prefix discovery, parameter discovery, address auto-configuration, address resolution (like ARP), next-hop determination, NUD, DAD, and redirection. NDP defines five ICMP packets: RS (ICMP type: 133), RA (ICMP type: 134), NS (similar to ARP request, ICMP type: 135), NA (similar to ARP reply, ICMP type: 136), ICMP Redirect (ICMP type: 137).

All the above ICMP packets carry one or multiple options. These options are optional in some cases but are significant in other cases. NDP mainly defines five options: Source Link-Layer Address Option, Type=1; Target Link-Layer Address Option, Type=2; Prefix Information Option, Type=3; Redirection Header Option, Type=4; MTU Option, Type=5.

Address Resolution

When a node attempts to communicate with another, the node has to obtain the link-layer address of the peer end by sending it an NS packet. In this packet, the destination address is the solicited-node multicast address corresponding to the IPv6 address of the destination node. This packet also contains the link-layer address of the source node. After receiving this NS packet, the peer end replies with an NA packet in which the destination address is the source address of the NS packet, that is, the link-layer address of the solicited node. After receiving this NA packet, the source node can communicate with the destination node.

Figure 3-11 shows the address resolution process.

Figure 3-11

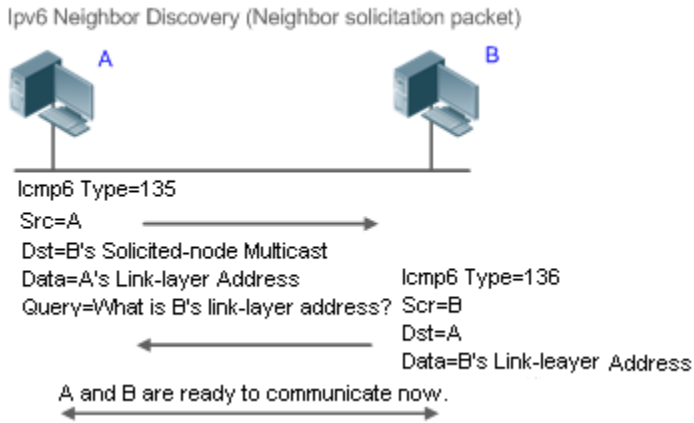

➤ **NUD**

If the reachable time of a neighbor has elapsed but an IPv6 unicast packet needs to be sent to it, the device performs NUD.

While performing NUD, the device can continue to forward IPv6 packets to the neighbor.

➤ **DAD**

To know whether the IPv6 address configured for a host is unique, the device needs to perform DAD by sending an NS packet in which the source IPv6 address is the unspecified address.

If a device detects an address conflict, this address is set to the duplicate status so that the device cannot receive IPv6 packets with this address being the destination address. Meanwhile, the device also starts a timer for this duplicate address to periodically perform DAD. If no address conflict is detected in re-detection, this address can be properly used.

➤ **Router, Prefix, and Parameter Discovery**

A device periodically sends RA packets to all local nodes on the link.

Figure 3-12 shows the RA packet sending process.

Figure 3-12

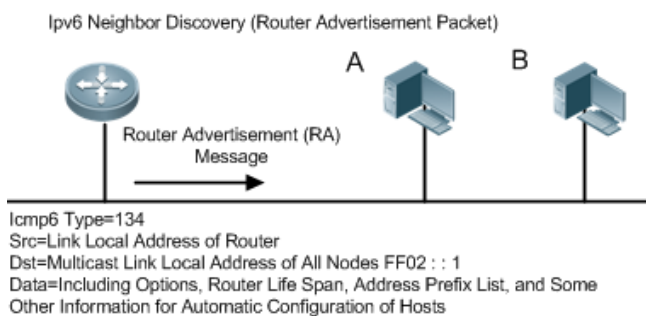

An RA packet usually contains the following content:

- One or multiple IPv6 address prefixes (used for on-link determination or stateless address auto-configuration)
- Validity of the IPv6 address prefix

- Host auto-configuration method (stateful or stateless)
- Default device information (whether the device acts as the default device; if yes, the interval for acting as the default device is also included.)
- Other information provided for host configuration, such as hop limit, MTU, and NS retransmission interval

RA packets can also be used as replies to the RS packets sent by a host. Using RS packets, a host can obtain the auto-configured information immediately after started rather than wait for the RA packets sent by the device. If no unicast address is configured for a newly started host, the host includes the unspecified address (0:0:0:0:0:0:0:0) as the source address in the RS packet. Otherwise, the host uses the configured unicast address as the source address and the multicast address of all local routing devices (FF02::2) as the destination address in the RS packet. As an reply to the RS packet, the RA packet uses the source address of the RS packet as the destination address (if the source address is the unspecified address, it uses the multicast address of all local nodes (FF02::1)).

In an RA packet, the following parameters can be configured:

- Ra-interval: Interval for sending the RA packet.
- Ra-lifetime: Lifetime of a router, that is, whether the device acts as the default router on the local link and the interval for acting as the default router.
- Prefix: Prefix of an IPv6 address on the local link. It is used for on-link determination or stateless address auto-configuration, including other parameter configurations related to the prefix.
- Ns-interval: NS packet retransmission interval.
- Reachabletime: Period when the device regards a neighbor reachable after detecting a Confirm Neighbor Reachability event.
- Ra-hoplimit: Hops of the RA packet, used to set the hop limit for a host to send a unicast packet.
- Ra-mtu: MTU of the RA packet.
- Managed-config-flag: Whether a host receiving this RA packet obtains the address through stateful auto-configuration.
- Other-config-flag: Whether a host receiving this RA packet uses DHCPv6 to obtain other information except the IPv6 address for auto-configuration.

Configure the above parameters when configuring IPv6 interface attributes.

↘ Redirection

If a router receiving an IPv6 packet finds a better next hop, it sends the ICMP Redirect packet to inform the host of the better next hop. The host will directly send the IPv6 packet to the better next hop next time.

↘ Maximum Number of Unresolved ND Entries

- You can configure the maximum number of unresolved ND entries to prevent malicious scanning network segments from generating a large number of unresolved ND entries and occupying excessive memory space.

↘ Maximum Number of ND Options

- You can configure the maximum number of ND options to prevent forged ND packets from carrying unlimited ND options and occupying excessive CPU space on the device.

↘ Maximum Number of Neighbor Learning Entries on an Interface

- You can configure the maximum number of neighbor learning entries on an interface to prevent neighbor learning attacks from occupying ND entries and memory space of the device and affecting forwarding efficiency of the device.

Related Configuration

↘ Enabling IPv6 Redirection

- By default, ICMPv6 Redirect packets can be sent on IPv6 interfaces.
- Run the **no ipv6 redirects** command in interface configuration mode to prohibit an interface from sending Redirect packets.

↘ Configuring IPv6 DAD

- By default, an interface sends one NS packet to perform IPv6 DAD.
- Run the **ipv6 nd dad attempts value** command in interface configuration mode to configure the number of NS packets consecutively sent by DAD. Value 0 indicates disabling DAD for IPv6 addresses on this interface.
- Run the **no ipv6 nd dad attempts** command to restore the default configuration.
- By default, the device performs DAD on duplicate IPv6 addresses every 60 seconds.
- Run the **ipv6 nd dad retry value** command in global configuration mode to configure the DAD interval. Value 0 indicates disabling DAD for the device.
- Run the **no ipv6 nd dad retry** command to restore the default configuration.

↘ Configuring the Reachable Time of a Neighbor

- The default reachable time of an IPv6 neighbor is 30s.
- Run the **ipv6 nd reachable-time milliseconds** command in interface configuration mode to modify the reachable time of a neighbor.

↘ Configuring the Stale Time of a Neighbor

- The default stale time of an IPv6 neighbor is 1 hour. After the time elapses, the device performs NUD.
- Run the **ipv6 nd stale-time seconds** command in interface configuration mode to modify the stale time of a neighbor.

↘ Configuring Prefix Information

- By default, the prefix in an RA packet on an interface is the prefix configured in the **ipv6 address** command on the interface.
- Run the **ipv6 nd prefix** command in interface configuration mode to add or delete prefixes and prefix parameters that can be advertised.

↘ Enabling/disabling RA Suppression

- By default, an IPv6 interface does not send RA packets.
- Run the **no ipv6 nd suppress-ra** command in interface configuration mode to disable RA suppression.

↘ **Configuring the Maximum Number of Unresolved ND Entries**

- The default value is 0, indicating no restriction. It is only restricted to the ND entry capacity supported by the device.
- Run the **ipv6 nd unresolved *number*** command in global configuration mode to restrict the number of unresolved neighbors. After the entries exceed this restriction, the device does not actively resolve subsequent packets.

↘ **Configuring the Maximum Number of ND Entries Learned on an Interface**

- Run the **ipv6 nd cache interface-limit *value*** command in interface configuration mode to restrict the number of neighbors learned on an interface. The default value is 0, indicating no restriction.

3.3.6 IPv6 Source Routing

Working Principle

Similar to the IPv4 loose source routing and loose record routing options, the IPv6 routing header is used to specify the intermediate nodes that the packet passes through along the path to the destination address. It uses the following format:

Figure 3-13

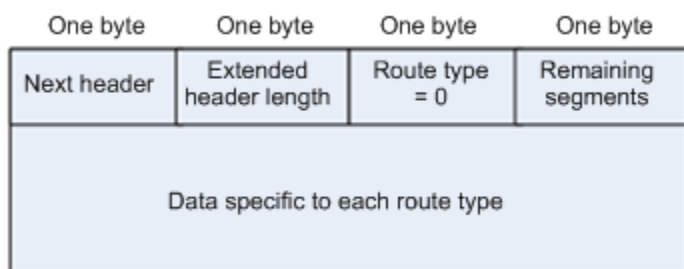

The Segments Left field is used to indicate how many intermediate nodes are specified in the routing header for the packet to pass through from the current node to the final destination address.

Currently, two routing types are defined: 0 and 2. The Type 2 routing header is used for mobile communication. RFC 2460 defines the Type 0 routing header (similar to the loose source routing option of IPv4). The format of the Type 0 routing header is as follows:

Figure 3-14

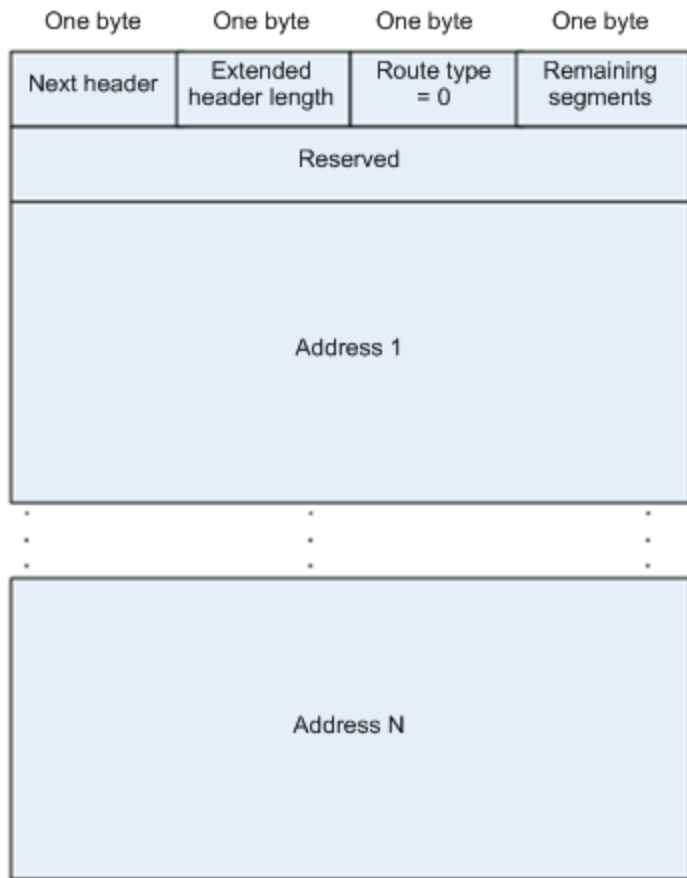

The following example describes the application of the Type 0 routing header, as shown in Figure 3-15.

Figure 3-15

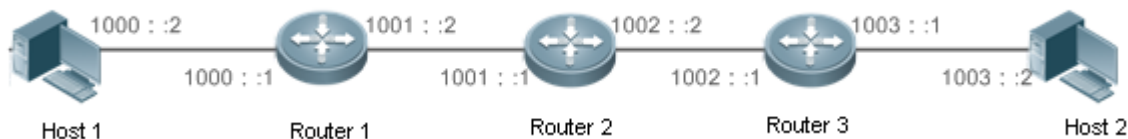

Host 1 sends Host 2 a packet specifying the intermediate nodes Router 2 and Router 3. The following table lists the changes of fields related to the IPv6 header and routing header during the forwarding process.

| Transmission Node | Fields in the IPv6 Header | Fields Related to the Type 0 Routing Header |
|-------------------|---|---|
| Host 1 | Source address=1000::2 Destination address=1001::1 (Address of Router 2) | Segments Left=2 Address 1=1002::1 (Address of Router 3) Address 2=1003::2 (Address of Host 2) |
| Router 1 | No change | |
| Router 2 | Source address=1000::2 Destination address=1002::1 (Address of Router 3) | Segments Left=1 Address 1=1001::1 (Address of Router 2) Address 2=1003::2 (Address of Host 2) |

| | | |
|----------|---|---|
| Router 3 | Source address=1000::2 Destination address=1003::2 (Address of Host 2) | Segments Left=0 Address 1=1001::1 (Address of Router 2) Address 2=1002::2 (Address of Router 3) |
| Host 2 | No change | |

The forwarding process is as follows:

- Host 1 sends a packet in which the destination address is Router 2's address 1001::1, the Type 0 routing header is filled with Router 3's address 1002::1 and Host 2's address 1003::2, and the value of the Segments Left field is 2.
- Router 1 forwards this packet to Router 2.
- Router 2 changes the destination address in the IPv6 header to Address 1 in the routing header. That is, the destination address becomes Router 3's address 1002::1, Address 1 in the routing header becomes Router 2's address 1001::1, and the value of the Segments Left field becomes 1. After modification, Router 2 forwards the packet to Router 3.
- Router 3 changes the destination address in the IPv6 header to Address 2 in the routing header. That is, the destination address becomes Host 2's address 1003::2, Address 2 in the routing header becomes Router 3's address 1002::1, and the value of the Segments Left field becomes 0. After modification, Router 3 forwards the packet to Host 2.

The Type 0 routing header may be used to initiate DoS attacks. As shown in Figure 3-16, Host 1 sends packets to Host 2 at 1 Mbps and forges a routing header to cause multiple round-trips between Router 2 and Router 3 (50 times from Router 2 to Router 3 and 49 times from Router 3 to Router 2). At the time, the routing header generates the traffic amplification effect: "50 Mbps from Router 2 to Router 3 and 49 Mbps from Router 3 to Router 2." Due to this security problem, RFC 5095 abolished the Type 0 routing header.

Figure 3-16

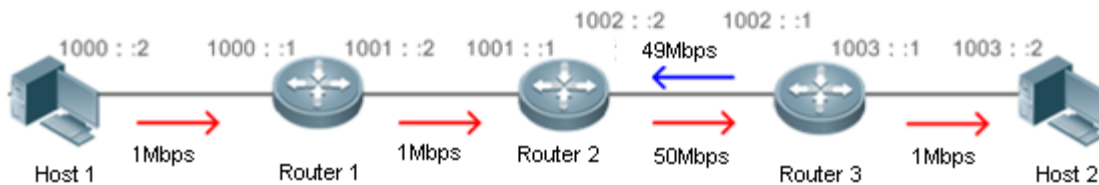

```

IPv6 Packet
Source Address 1000::2
Destination Address 1001::1

Segments Left in the Type 0
Routing Header: 100
Address 1: 1002::1
Address 2: 1001::1
Address 3: 1002::1
Address 4: 1002::1
...
Address 99: 1002::1
Address 100: 1003::2
    
```

Host 1 sends packets to Host 2, passing through Router 2, Router 3, Router 2, and Router 3, ...
Each packet is sent 50 times from Router 2 to Router 3 and 49 times from Router 3 to Router 2.

Related Configuration

- Enabling IPv6 Source Routing

- The Type 0 routing header is not supported by default.
- Run the **ipv6 source-route** command in global configuration mode to enable IPv6 source routing.

3.3.7 Restricting the Sending Rate of ICMPv6 Error Messages

Working Principle

The destination node or intermediate router sends ICMPv6 error messages to report the errors incurred during IPv6 data packet forwarding and transmission. There are mainly four types of error messages: Destination Unreachable, Packet Too Big, Time Exceeded, and Parameter Problem.

When receiving an invalid IPv6 packet, a device discards the packet and sends back an ICMPv6 error message to the source IPv6 address. In the case of invalid IPv6 packet attacks, the device may continuously reply to ICMPv6 error messages till device resources are exhausted and thereby fail to properly provide services. To solve this problem, you can restrict the sending rate of ICMPv6 error messages.

If the length of an IPv6 packet to be forwarded exceeds the IPv6 MTU of the outbound interface, the router discards this IPv6 packet and sends back an ICMPv6 Packet Too Big message to the source IPv6 address. This error message is mainly used as part of the IPv6 PMTUD process. If the sending rate of ICMPv6 error messages is restricted due to excessive other ICMPv6 error messages, ICMPv6 Packet Too Big messages may be filtered, causing failure of IPv6 PMTUD. Therefore, it is recommended to restrict the sending rate of ICMPv6 Packet Too Big messages independently of other ICMPv6 error messages.

Although ICMPv6 Redirect packets are not ICMPv6 error messages, Ruijie recommends restricting their rates together with ICMPv6 error messages except Packet Too Big messages.

Related Configuration

▾ **Configuring the Sending Rate of ICMPv6 Packet Too Big Messages**

- The default rate is 10 per 100 ms.
- Run the **ipv6 icmp error-interval too-big** command to configure the sending rate of ICMPv6 Packet Too Big messages.

▾ **Configuring the Sending Rate of Other ICMPv6 Error Messages**

- The default rate is 10 per 100 ms.
- Run the **ipv6 icmp error-interval** command to configure the sending rate of other ICMPv6 error messages.

3.3.8 IPv6 Hop Limit

Working Principle







An IPv6 data packet passes through routers from the source address and destination address. If a hop limit is configured, it decreases by one every time the packet passes through a router. When the hop limit decreases to 0, the router discards the packet to prevent this useless packet from being unlimitedly transmitted on the network and wasting network bandwidth. The hop limit is similar to the TTL of IPv4.



Related Configuration

↳ Configuring the IPv6 Hop Limit

- The default IPv6 hop limit of a device is 64.
- Run the `ipv6 hop-limit` command to configure the IPv6 hop limit of a device.

3.4 Configuration

| Configuration | Description and Command |
|---|---|
| Configuring an IPv6 Address |  (Mandatory) It is used to configure IPv6 addresses and enable IPv6. |
| | ipv6 enable Enables IPv6 on an interface. |
| | ipv6 address Configures the IPv6 unicast address of an interface. |
| Configuring IPv6 NDP |  (Optional) It is used to enable IPv6 redirection on an interface. |
| | ipv6 redirects Enables IPv6 redirection on an interface. |
| |  (Optional) It is used to enable DAD. |
| | ipv6 nd dad attempts Configures the number of consecutive NS packets sent during DAD. |
| |  (Optional) It is used to configure ND parameters. |
| | ipv6 nd reachable-time Configures the reachable time of a neighbor. |
| | ipv6 nd prefix Configures the address prefix to be advertised in an RA packet. |
| | ipv6 nd suppress-ra Enables RA suppression on an interface. |
| |  (Optional) It is used to configure the maximum number of unresolved ND entries. |
| ipv6 nd unresolved Configures the maximum number of unresolved ND entries. | |
| Enabling PMTUD |  (Optional) It is used to restrict the MTU of IPv6 packets sent on an interface. |
| | ipv6 mtu Configures the IPv6 MTU. |
| |  (Optional) It is used to enable IPv6 source routing. |
| Enabling IPv6 Source Routing | ipv6 source-route Configures the device to forward IPv6 packets carrying the routing header. |

| Configuration | Description and Command |
|---|---|
| Configuring the Sending Rate of ICMPv6 Error Messages |  Optional. |
| | ipv6 icmp error-interval too-big Configures the sending rate of ICMPv6 Packet Too Big messages. |
| | ipv6 icmp error-interval Configures the sending rates of other ICMPv6 error messages and ICMPv6 Redirect packets. |
| Configuring the IPv6 Hop Limit |  (Optional) It is used to restrict the hop limit of IPv6 unicast packets sent on an interface. |
| | ipv6 hop-limit Configures the IPv6 hop limit. |

3.4.1 Configuring an IPv6 Address

Configuration Effect

Configure the IPv6 address of an interface to implement IPv6 network communication.

Configuration Steps

↳ Enabling IPv6 on an Interface

- (Optional) If you do not want to enable IPv6 by configuring an IPv6 address, run the **ipv6 enable** command.

↳ Configuring the IPv6 Unicast Address of an Interface

- Mandatory.

Verification

Run the **show ipv6 interface** command to check whether the configured address takes effect.

Related Commands

↳ Enabling IPv6 on an Interface

| | |
|------------------------------|--|
| Command | ipv6 enable |
| Parameter Description | N/A |
| Command Mode | Interface configuration mode |
| Usage Guide | IPv6 can be enabled on an interface by two methods: 1) running the ipv6 enable command in interface configuration mode; 2) configuring an IPv6 address on the interface. If an IPv6 address is configured on an interface, IPv6 is automatically enabled on this interface. In this case, IPv6 cannot be disabled even when you run the no ipv6 enable command. |

↳ Configuring the IPv6 Unicast Address of an Interface

| | |
|----------------|---|
| Command | ipv6 address <i>ipv6-address / prefix-length</i> |
|----------------|---|

| | |
|------------------------------|---|
| | <p>ipv6 address <i>ipv6-prefix / prefix-length eui-64</i></p> <p>ipv6 address <i>prefix-name sub-bits / prefix-length [eui-64]</i></p> |
| Parameter Description | <p><i>ipv6-address</i>: Indicates the IPv6 address, which must comply with the address format defined in RFC 4291. Separated by a colon (:), each address field consists of 16 bits and is represented by hexadecimal digits.</p> <p><i>ipv6-prefix</i>: Indicates the IPv6 address prefix, which must comply with the address format defined in RFC 4291.</p> <p><i>prefix-length</i>: Indicates the length of the IPv6 address prefix, that is, the part representing the network in the IPv6 address.</p> <p><i>prefix-name</i>: Indicates the name of the universal prefix. This specified universal prefix is used to create the interface address.</p> <p><i>sub-bits</i>: Indicates the subprefix bits and host bits of the address to be concatenated with the prefixes provided by the general prefix specified with the <i>prefix-name</i> parameter. This value is combined with the universal prefix to create the interface address. This value must be in the form documented in RFC 4291.</p> <p><i>eui-64</i>: Indicates the created IPv6 address, consisting of the configured address prefix and 64-bit interface ID.</p> |
| Command Mode | Interface configuration mode |
| Usage Guide | <p>If an IPv6 interface is created and is Up state, the system automatically generates a link-local address for this interface.</p> <p>The IPv6 address of an interface can also be created by the universal prefix mechanism. That is, IPv6 address = Universal prefix + Sub prefix + Host bits. The universal prefix can be configured by running the ipv6 general-prefix command or learned by the prefix discovery function of the DHCPv6 client (see the <i>Configuring DHCPv6</i>). Sub prefix + Host bits are specified by the <i>sub-bits</i> and <i>prefix-length</i> parameters in the ipv6 address command.</p> <p>If you run the no ipv6 address command without specifying an address, all manually configured addresses will be deleted.</p> <p>Run the no ipv6 address <i>ipv6-prefix/prefix-length eui-64</i> command to delete the configured address.</p> |

Configuration Example

Configuring an IPv6 Address on an Interface

| | |
|----------------------------|---|
| Configuration Steps | Enable IPv6 on the GigabitEthernet 0/0 interface and add IPv6 address 2000::1 to the interface. |
| | <pre>Ruijie(config)#interface gigabitEthernet 0/0 Ruijie(config-if-GigabitEthernet 0/0)#ipv6 enable Ruijie(config-if-GigabitEthernet 0/0)#ipv6 address 2000::1/64</pre> |
| Verification | Run the show ipv6 interface command to verify that an address is successfully added to the GigabitEthernet 0/0 interface. |
| | <pre>Ruijie(config-if-GigabitEthernet 0/0)#show ipv6 interface gigabitEthernet 0/0</pre> |

```
interface GigabitEthernet 0/0 is Down, ifindex: 1, vrf_id 0
address(es):
  Mac Address: 00:00:00:00:00:00
  INET6: FE80::200:FF:FE00:1 [ TENTATIVE ], subnet is FE80::/64
  INET6: 2000::1 [ TENTATIVE ], subnet is 2000::/64
Joined group address(es):
MTU is 1500 bytes
ICMP error messages limited to one every 100 milliseconds
ICMP redirects are enabled
ND DAD is enabled, number of DAD attempts: 1
ND reachable time is 30000 milliseconds
ND advertised reachable time is 0 milliseconds
ND retransmit interval is 1000 milliseconds
ND advertised retransmit interval is 0 milliseconds
ND router advertisements are sent every 200 seconds<160--240>
ND router advertisements live for 1800 seconds
```

3.4.2 Configuring IPv6 NDP

Configuration Effect

Configure NDP-related attributes, for example, enable IPv6 redirection and DAD.

Notes

RA suppression is enabled on interfaces by default. To configure a device to send RA packets, run the **no ipv6 nd suppress-ra** command in interface configuration mode.

Configuration Steps

▾ Enabling IPv6 Redirection on an Interface

- (Optional) IPv6 redirection is enabled by default.
- To disable IPv6 redirection on an interface, run the **no ipv6 redirects** command.

▾ Configuring the Number of Consecutive NS Packets Sent During DAD

- Optional.

- To prevent enabling DAD for IPv6 addresses on an interface or modify the number of consecutive NS packets sent during DAD, run the **ipv6 nd dad attempts** command.

▾ Configuring the Reachable Time of a Neighbor

- Optional.
- To modify the reachable time of a neighbor, run the **ipv6 nd reachable-time** command.

▾ Configuring the Address Prefix to Be Advertised in an RA Packet

- By default, the prefix in an RA packet on an interface is the prefix configured in the **ipv6 address** command on the interface.
- (Optional) Run the **ipv6 nd prefix** command to add or delete prefixes and prefix parameters that can be advertised. Or run the **peer default ipv6 pool** command to assign a prefix from the prefix pool for advertisement

▾ Enabling/Disabling RA Suppression on an Interface

- Optional.
- If a device needs to send RA packets, run the **no ipv6 nd suppress-ra** command.

▾ Configuring the Maximum Number of Unresolved ND Entries

- Optional.
- If a large number of unresolved ND entries are generated due to scanning attacks, run the **ipv6 nd unresolved** command to restrict the number of unresolved neighbors.

▾ Configuring the Maximum Number of ND Options

- Optional.
- If a device needs to process more options, run the **ipv6 nd max-opt** command.

▾ Configuring the Maximum Number of ND Entries Learned on an Interface

- Optional.
- If the number of IPv6 hosts is controllable, run the **ipv6 nd cache interface-limit** command to restrict the number of neighbors learned on an interface. This prevents ND learning attacks from occupying the memory space and affecting device performance.

Verification

Run the following commands to check whether the configuration is correct:

- **show ipv6 interface** *interface-type interface-num*: Check whether the configurations such as the redirection function, reachable time of a neighbor, and NS sending interval take effect.
- **show ipv6 interface** *interface-type interface-num ra-inifo*: Check whether the prefix and other information configured for RA packets are correct.
- **show run**

Related Commands

↳ Enabling IPv6 Redirection on an Interface

| | |
|------------------------------|---|
| Command | ipv6 redirects |
| Parameter Description | N/A |
| Command Mode | Interface configuration mode |
| Usage Guide | All ICMPv6 error messages are transmitted at a limited transmission rate. By default, a maximum number of 10 ICMPv6 error messages are transmitted per second (10 pps). |

↳ Configuring the Number of Consecutive NS Packets Sent During DAD

| | |
|------------------------------|---|
| Command | ipv6 nd dad attempts <i>value</i> |
| Parameter Description | <i>value</i> : Indicates the number of NS packets. |
| Command Mode | Interface configuration mode |
| Usage Guide | You need to enable DAD before configuring an IPv6 address on an interface. Then the address is in tentative state. If no address conflict is detected by DAD, this address can be correctly used. If an address conflict is detected and the interface ID of this address uses EUI-64, duplicate link-layer addresses exist on this link. In this case, the system automatically disables this interface to prevent IPv6-related operations on this interface). At the time, you must configure a new address and restart the interface to re-enable DAD. When an interface changes from the down state to the up state, DAD is re-enabled for the addresses on this interface. |

↳ Configuring the Reachable Time of a Neighbor

| | |
|------------------------------|--|
| Command | ipv6 nd reachable-time <i>milliseconds</i> |
| Parameter Description | <i>milliseconds</i> : Indicates the reachable time of a neighbor, ranging from 0 to 3,600,000. The unit is millisecond. The default value is 30s. |
| Command Mode | Interface configuration mode |
| Usage Guide | A device detects unreachable neighbors based on the configured reachable time. The shorter the configured reachable time, the faster the device detects unreachable neighbors but the more it consumes network bandwidth and device resources. Therefore, it is not recommended to set this time too small. The configured value is advertised in an RA packet and is also used on the device. If the value is 0, the reachable time is not specified on the device and it is recommended to use the default value. |

↳ Configuring the Address Prefix to Be Advertised in an RA Packet

| | |
|----------------|--|
| Command | ipv6 nd prefix { <i>ipv6-prefix/prefix-length</i> default } [[<i>valid-lifetime</i> { infinite <i>preferred-lifetime</i> }]] [[<i>at valid-date preferred-date</i>]] [infinite { infinite <i>preferred-lifetime</i> }]] [no-advertise] [[off-link] [no-autoconfig]] |
|----------------|--|

| | |
|------------------------------|---|
| Parameter Description | <p><i>ipv6-prefix</i>: Indicates the network ID of IPv6, which must comply with the address representation format in RFC 4291.</p> <p><i>prefix-length</i>: Indicates the length of the IPv6 address prefix. A slash (/) must be added before the prefix.</p> <p><i>valid-lifetime</i>: Indicates the period when a host receiving the prefix of an RA packet regards the prefix valid. The value ranges from 0 to 4,294,967,295. The default value is 30 days.</p> <p><i>preferred-lifetime</i>: Indicates the preferred period when a host receiving the prefix of an RA packet regards the prefix valid. The value ranges from 0 to 4,294,967,295. The default value is 7 days.</p> <p>at valid-date preferred-date: Indicates the valid date and preferred deadline configured for the RA prefix. It uses the format of <i>dd+mm+yyyy+hh+mm</i>.</p> <p>infinite: Indicates that the prefix is permanently valid.</p> <p>default: Indicates that the default parameter configuration is used.</p> <p>no-advertise: Indicates that the prefix is not advertised by a router.</p> <p>off-link: If the prefix of the destination address in the IPv6 packet sent by a host matches the configured prefix, the device regards the destination address on the same link and directly reachable. This parameter indicates that this prefix does not require on-link determination.</p> <p>no-autoconfig: Indicates that the prefix in the RA packet received by a host cannot be used for address auto-configuration.</p> |
| Command Mode | Interface configuration mode |
| Usage Guide | <p>This command can be used to configure parameters related to each prefix, including whether to advertise this prefix. By default, an RA packet uses the prefix configured by running the ipv6 address command. Run the ipv6 nd prefix command to add other prefixes.</p> <p>Run the ipv6 nd prefix default command to configure the default parameters for an interface. That is, if no parameter is specified when a prefix is added, use the parameters configured in the ipv6 nd prefix default command as the parameters of the new prefix. The default parameter configurations are abandoned once a parameter is specified for the prefix. That is, when you use the ipv6 nd prefix default command to modify the default parameter configurations, only the prefix configured for the default parameters changes and configurations of the prefix remain the same.</p> <p>at valid-date preferred-date: You can specify the valid date of the prefix in two methods: 1) specifying a fixed time for each prefix in an RA packet; 2) specifying the deadline. In the second method, the valid date of the prefix in each RA packet decreases till it becomes 0.</p> |

📌 Enabling/Disabling RA Suppression on an Interface

| | |
|------------------------------|--|
| Command | ipv6 nd suppress-ra |
| Parameter Description | N/A |
| Command Mode | Interface configuration mode |
| Usage Guide | To enable RA suppression on an interface, run the ipv6 suppress-ra command. |

📌 Configuring the Maximum Number of Unresolved ND Entries

| | |
|------------------------------|--|
| Command | ipv6 nd unresolved <i>number</i> |
| Parameter Description | <i>number</i> : Indicates the maximum number of unresolved ND entries. |
| Command Mode | Global configuration mode |
| Usage Guide | To prevent malicious scanning attacks from creating a large number of unresolved ND entries and occupying entry resources, you can restrict the number of unresolved ND entries. |

↘ Configuring the Maximum Number of ND Entries Learned on an Interface

| | |
|------------------------------|---|
| Command | ipv6 nd cache interface-limit <i>value</i> |
| Parameter Description | <i>value</i> : Indicates the maximum number of neighbors learned by an interface. |
| Command Mode | Interface configuration mode |
| Usage Guide | Restricting the number of ND entries learned on an interface can prevent malicious neighbor attacks. If this number is not restricted, a large number of ND entries will be generated on the device, occupying excessive memory space. The configured value must be equal to or greater than the number of the ND entries learned by the interface. Otherwise, the configuration does not take effect. The configuration is subject to the ND entry capacity supported by the device. |

Configuration Example

↘ Enabling IPv6 Redirection on an Interface

| | |
|----------------------------|---|
| Configuration Steps | Enable IPv6 redirection on interface GigabitEthernet 0/0. |
| | <pre>Ruijie(config-if-GigabitEthernet 0/0)#ipv6 redirects</pre> |
| Verification | Run the show ipv6 interface command to check whether the configuration takes effect. |
| | <pre>Ruijie#show ipv6 interface gigabitEthernet 0/0 interface GigabitEthernet 0/0 is Down, ifindex: 1, vrf_id 0 address(es): Mac Address: 00:00:00:00:00:00 INET6: FE80::200:FF:FE00:1 [TENTATIVE], subnet is FE80::/64 Joined group address(es): MTU is 1500 bytes ICMP error messages limited to one every 100 milliseconds ICMP redirects are enabled</pre> |

| | |
|----------------------------|---|
| Configuration Steps | Enable IPv6 redirection on interface GigabitEthernet 0/0. |
| | <pre>Ruijie(config-if-GigabitEthernet 0/0)#ipv6 redirects</pre> |
| Verification | Run the show ipv6 interface command to check whether the configuration takes effect. |
| | <pre>ND DAD is enabled, number of DAD attempts: 1 ND reachable time is 30000 milliseconds ND advertised reachable time is 0 milliseconds ND retransmit interval is 1000 milliseconds ND advertised retransmit interval is 0 milliseconds ND router advertisements are sent every 200 seconds<160--240> ND router advertisements live for 1800 seconds</pre> |

↘ Configuring IPv6 DAD

| | |
|----------------------------|---|
| Configuration Steps | Configure the interface to send three consecutive NS packets during DAD. |
| | <pre>Ruijie(config-if-GigabitEthernet 0/0)# ipv6 nd dad attempts 3</pre> |
| Verification | Run the show ipv6 interface command to check whether the configuration takes effect. |
| | <pre>Ruijie#show ipv6 interface gigabitEthernet 0/0 interface GigabitEthernet 0/0 is Down, ifindex: 1, vrf_id 0 address(es): Mac Address: 00:00:00:00:00:00 INET6: FE80::200:FF:FE00:1 [TENTATIVE], subnet is FE80::/64 Joined group address(es): MTU is 1500 bytes ICMP error messages limited to one every 100 milliseconds ICMP redirects are enabled ND DAD is enabled, number of DAD attempts: 3 ND reachable time is 30000 milliseconds ND advertised reachable time is 0 milliseconds ND retransmit interval is 1000 milliseconds ND advertised retransmit interval is 0 milliseconds ND router advertisements are sent every 200 seconds<160--240></pre> |

```
ND router advertisements live for 1800 seconds
Ruijie(config-if-GigabitEthernet 0/0)#
```

📌 Configuring Prefix Information in an RA Packet

| | |
|----------------------------|--|
| Configuration Steps | Add a prefix 1234::/64 to interface GigabitEthernet 0/0. |
| | <pre>Ruijie(config-if-GigabitEthernet 0/0)#ipv6 nd prefix 1234::/6</pre> |
| Verification | Run the show ipv6 interface command to check whether the configuration takes effect. |
| | <pre>Ruijie#show ipv6 interface gigabitEthernet 0/0 ra-info GigabitEthernet 0/0: DOWN (RA is suppressed) RA timer is stopped waits: 0, initcount: 0 statistics: RA(out/in/inconsistent): 0/0/0, RS(input): 0 Link-layer address: 00:00:00:00:00:00 Physical MTU: 1500 ND router advertisements live for 1800 seconds ND router advertisements are sent every 200 seconds<160--240> Flags: !M!0, Adv MTU: 1500 ND advertised reachable time is 0 milliseconds ND advertised retransmit time is 0 milliseconds ND advertised CurHopLimit is 64 Prefixes: <total: 1> 1234::/64(Def, CFG, vltimer: 2592000, pltime: 604800, flags: LA)</pre> |

📌 Configuring RA Packets to Obtain Prefixes from the Prefix Pool

| | |
|----------------------------|--|
| Configuration Steps | Configure RA packets to obtain prefixes from the prefix pool "ra-pool". |
| | <pre>Ruijie(config-if-GigabitEthernet 0/0)#peel default ipv6 pool ra-pool</pre> |
| Verification | Run the show run command to check whether the configuration takes effect. |
| | <pre>Ruijie(config-if-GigabitEthernet 0/0)#show run interface gigabitEthernet 0/0 Building configuration...</pre> |

| | |
|----------------------------|---|
| Configuration Steps | Configure RA packets to obtain prefixes from the prefix pool "ra-pool". |
| | <pre>Ruijie(config-if-GigabitEthernet 0/0)#peel default ipv6 pool ra-pool</pre> |
| Verification | Run the show run command to check whether the configuration takes effect. |
| | <pre>Current configuration : 125 bytes interface GigabitEthernet 0/0 ipv6 enable no ipv6 nd suppress-ra peel default ipv6 pool ra-pool !</pre> |

↘ Disabling RA Suppression

| | |
|----------------------------|---|
| Configuration Steps | Disable RA suppression on an interface. |
| | <pre>Ruijie(config-if-GigabitEthernet 0/0)# no ipv6 nd suppress-ra</pre> |
| Verification | Run the show run command to check whether the configuration takes effect. |
| | <pre>Ruijie(config-if-GigabitEthernet 0/0)#show run interface gigabitEthernet 0/0 Building configuration... Current configuration : 125 bytes interface GigabitEthernet 0/0 ipv6 enable no ipv6 nd suppress-ra !</pre> |

↘ Configuring the Maximum Number of Unresolved ND Entries

| | |
|----------------------------|--|
| Configuration Steps | Set the maximum number of unresolved ND entries to 200. |
| | <pre>Ruijie(config)# ipv6 nd unresolved 200</pre> |
| Verification | Run the show run command to check whether the configuration takes effect. |
| | <pre>Ruijie#show run</pre> |

| | |
|----------------------------|--|
| Configuration Steps | Set the maximum number of unresolved ND entries to 200. |
| | <pre>Ruijie(config)# ipv6 nd unresolved 200</pre> |
| Verification | Run the show run command to check whether the configuration takes effect. |
| | <pre>ipv6 nd unresolved 200 !</pre> |

↘ **Configuring the Maximum Number of ND Entries Learned on an Interface**

| | |
|----------------------------|--|
| Configuration Steps | Set the maximum number of ND entries learned on an interface to 100. |
| | <pre>Ruijie(config-if-GigabitEthernet 0/1)# ipv6 nd cache interface-limit 100</pre> |
| Verification | Run the show run command to check whether the configuration takes effect. |
| | <pre>Ruijie#show run ! interface GigabitEthernet 0/1 ipv6 nd cache interface-limit 100 !</pre> |

3.4.3 Enabling PMTUD

Configuration Effect

When sending an IPv6 packet, a host fragments the packet based on the PMTU.

Notes

The IPv6 MTU of an interface must be less than or equal to the interface MTU.

Configuration Steps

↘ **Configuring the IPv6 MTU of an Interface**

- Optional.

Verification

- Run the **show run** command to check whether the configuration is correct.
- Run the **show ipv6 interface** command to check whether the IPv6 MTU of an interface is correct.

- Capture the locally sent IPv6 packets of which the length exceeds the PMTU. The packet capture result shows that the IPv6 packet is fragmented based on the PMTU.

Related Commands

▾ Configuring the IPv6 MTU of an Interface

| | |
|------------------------------|--|
| Command | <code>ipv6 mtu bytes</code> |
| Parameter Description | <i>bytes</i> : Indicates the MTU of an IPv6 packet, ranging from 1280 to 1500. The unit is byte. |
| Command Mode | Interface configuration mode |
| Usage Guide | N/A |

Configuration Example

▾ Configuring the IPv6 MTU of an Interface

| | |
|----------------------------|--|
| Configuration Steps | Change the IPv6 MTU of interface GigabitEthernet 0/0 to 1,300. |
| | <pre>Ruijie(config-if-GigabitEthernet 0/0)#ipv6 mtu 1300</pre> |
| Verification | Run the show ipv6 interface command to check whether the configuration takes effect. |
| | <pre>Ruijie(config-if-GigabitEthernet 0/0)#show ipv6 interface interface GigabitEthernet 0/ is Down, ifindex: 1, vrf_id 0 address(es): Mac Address: 00:d0:f8:22:33:47 INET6: FE80::2D0:F8FF:FE22:3347 [TENTATIVE], subnet is FE80::/64 INET6: 1020::1 [TENTATIVE], subnet is 1020::/64 INET6: 1023::1 [TENTATIVE], subnet is 1023::/64 Joined group address(es): MTU is 1300 bytes ICMP error messages limited to one every 100 milliseconds ICMP redirects are enabled ND DAD is enabled, number of DAD attempts: 1 ND reachable time is 30000 milliseconds ND advertised reachable time is 0 milliseconds ND retransmit interval is 1000 milliseconds</pre> |

| | |
|----------------------------|---|
| Configuration Steps | Change the IPv6 MTU of interface GigabitEthernet 0/0 to 1,300. |
| | <pre>Ruijie(config-if-GigabitEthernet 0/0)#ipv6 mtu 1300</pre> |
| Verification | Run the show ipv6 interface command to check whether the configuration takes effect. |
| | <pre>ND advertised retransmit interval is 0 milliseconds ND router advertisements are sent every 200 seconds<160--240> ND router advertisements live for 1800 seconds</pre> |

3.4.4 Enabling IPv6 Source Routing

Configuration Effect

RFC 5095 abolished the Type 0 routing header. Ruijie devices do not support the Type 0 routing header by default. The administrator can run the **ipv6 source-route** command to in global configuration mode to enable IPv6 source routing.

Configuration Steps

▾ Enabling IPv6 Source Routing

- Optional.
- To enable IPv6 source routing, run the **ipv6 source-route** command.

Verification

The device can properly forward packets carrying the Type 0 routing header.

Related Commands

▾ Enabling IPv6 Source Routing

| | |
|------------------------------|---|
| Command | ipv6 source-route |
| Parameter Description | N/A |
| Command Mode | Global configuration mode |
| Usage Guide | Since the Type 0 header may cause the device prone to DoS attacks, the device does not forward IPv6 packets carrying the routing header by default, but still processes IPv6 packets with itself being the final destination address and the Type 0 routing header. |

Configuration Example

▾ Enabling IPv6 Source Routing

| | |
|----------------------------|-----------------------------|
| Configuration Steps | Enable IPv6 source routing. |
|----------------------------|-----------------------------|

| | |
|---------------------|--|
| | Ruijie(config)#ipv6 source-route |
| Verification | Run the show run command to check whether the configuration takes effect. |
| | Ruijie#show run inc ipv6 source-route ipv6 source-route |

3.4.5 Configuring the Sending Rate of ICMPv6 Error Messages

Configuration Effect

Configure the sending rate of ICMPv6 error messages.

Configuration Steps

▾ Configuring the Sending Rate of ICMPv6 Packet Too Big Messages

- Optional.
- If a device receives many IPv6 packets with the packet length exceeding the IPv6 MTU of the outbound interface and thereby sends many ICMPv6 Packet Too Big messages to consume much CPU resources, run the **ipv6 icmp error-interval too-big** command to restrict the sending rate of this error message.

▾ Configuring the Sending Rate of Other ICMPv6 Error Messages

- Optional.
- If a device receives many illegal IPv6 packets and thereby generates many ICMPv6 error messages, run the **ipv6 icmp error-interval** command to restrict the sending rate of ICMPv6 error messages. (This command does not affect the sending rate of ICMPv6 Packet Too Big messages.)

Verification

Run the **show running-config** command to check whether the configuration takes effect.

Related Commands

▾ Configuring the Sending Rate of ICMPv6 Packet Too Big Messages

| | |
|------------------------------|---|
| Command | ipv6 icmp error-interval too-big <i>milliseconds</i> [<i>bucket-size</i>] |
| Parameter Description | <i>milliseconds</i> : Indicates the refresh period of a token bucket, ranging from 0 to 2,147,483,647. The unit is millisecond. The default value is 100. If the value is 0, the sending rate of ICMPv6 error messages is not restricted. <i>bucket-size</i> : Indicates the number of tokens in a token bucket, ranging from 1 to 200. The default value is 10. |
| Command Mode | Global configuration mode |
| Usage Guide | To prevent DoS attacks, use the token bucket algorithm to restrict the sending rate of ICMPv6 error |

| | |
|--|---|
| | <p>messages.</p> <p>If the length of an IPv6 packet to be forwarded exceeds the IPv6 MTU of the outbound interface, the router discards this IPv6 packet and sends back an ICMPv6 Packet Too Big message to the source IPv6 address. This error message is mainly used as part of the IPv6 PMTUD process. If other ICMPv6 error messages are excessive, ICMPv6 Packet Too Big messages cannot be sent, causing failure of IPv6 PMTUD. Therefore, it is recommended to restrict the sending rate of ICMPv6 Packet Too Big messages independently of other ICMPv6 error messages.</p> <p>Since the precision of the timer is 10 milliseconds, it is recommended to set the refresh period of a token bucket to an integer multiple of 10 milliseconds. If the refresh period of the token bucket is between 0 and 10, the actual refresh period is 10 milliseconds. For example, if the sending rate is set to 1 every 5 milliseconds, two error messages are sent every 10 milliseconds in actual situations. If the refresh period of the token bucket is not an integer multiple of 10 milliseconds, it is automatically converted to an integer multiple of 10 milliseconds. For example, if the sending rate is set to 3 every 15 milliseconds, two tokens are refreshed every 10 milliseconds in actual situations.</p> |
|--|---|

📌 Configuring the Sending Rate of Other ICMPv6 Error Messages

| | |
|------------------------------|--|
| Command | <code>ipv6 icmp error-interval milliseconds [bucket-size]</code> |
| Parameter Description | <p><i>milliseconds</i>: Indicates the refresh period of a token bucket, ranging from 0 to 2,147,483,647. The unit is millisecond. The default value is 100. If the value is 0, the sending rate of ICMPv6 error messages is not restricted.</p> <p><i>bucket-size</i>: Indicates the number of tokens in a token bucket, ranging from 1 to 200. The default value is 10.</p> |
| Command Mode | Global configuration mode |
| Usage Guide | <p>To prevent DoS attacks, use the token bucket algorithm to restrict the sending rate of ICMPv6 error messages.</p> <p>Since the precision of the timer is 10 milliseconds, it is recommended to set the refresh period of a token bucket to an integer multiple of 10 milliseconds. If the refresh period of the token bucket is between 0 and 10, the actual refresh period is 10 milliseconds. For example, if the sending rate is set to 1 every 5 milliseconds, two error messages are sent every 10 milliseconds in actual situations. If the refresh period of the token bucket is not an integer multiple of 10 milliseconds, it is automatically converted to an integer multiple of 10 milliseconds. For example, if the sending rate is set to 3 every 15 milliseconds, two tokens are refreshed every 10 milliseconds in actual situations.</p> |

Configuration Example

📌 Configuring the Sending Rate of ICMPv6 Error Messages

| | |
|----------------------------|---|
| Configuration Steps | Set the sending rate of the ICMPv6 Packet Too Big message to 100 pps and that of other ICMPv6 error messages to 10 pps. |
|----------------------------|---|

| | |
|---------------------|---|
| | <pre>Ruijie(config)#ipv6 icmp error-interval too-big 1000 100 Ruijie(config)#ipv6 icmp error-interval 1000 10</pre> |
| Verification | Run the show running-config command to check whether the configuration takes effect. |
| | <pre>Ruijie#show running-config include ipv6 icmp error-interval ipv6 icmp error-interval 1000 10 ipv6 icmp error-interval too-big 1000 100</pre> |

3.4.6 Configuring the IPv6 Hop Limit

Configuration Effect

Configure the number of hops of a unicast packet to prevent the packet from being unlimitedly transmitted.

Configuration Steps

▾ Configuring the IPv6 Hop Limit

- Optional.
- To modify the number of hops of a unicast packet, run the **ipv6 hop-limit value** command.

Verification

- Run the **show running-config** command to check whether the configuration is correct.
- Capture the IPv6 unicast packets sent by a host. The packet capture result shows that the hop-limit field value in the IPv6 header is the same as the configured hop limit.

Related Commands

▾ Configuring the IPv6 Hop Limit

| | |
|------------------------------|---|
| Command | ipv6 hop-limit value |
| Parameter Description | <i>value</i> : Indicates the number of hops of a unicast packet sent by the device. The value ranges from 1 to 255. |
| Command Mode | Global configuration mode |
| Usage Guide | N/A |

Configuration Example

▾ Configuring the IPv6 Hop Limit

| | |
|----------------------------|---|
| Configuration Steps | Change the IPv6 hop limit of a device to 250. |
| | <pre>Ruijie(config)#ipv6 hop-limit 250</pre> |

| | |
|---------------------|---|
| Verification | Run the show running-config command to check whether the configuration takes effect. |
| | <pre>Ruijie#show running-config ipv6 hop-limit 254</pre> |

3.5 Monitoring

Clearing

 Running the **clear** commands may lose vital information and thus interrupt services.

| Description | Command |
|---|---|
| Clears the dynamically learned neighbors. | clear ipv6 neighbors [<i>interface-id</i>] |

Displaying

| Description | Command |
|--|--|
| Displays IPv6 information of an interface. | show ipv6 interface [[<i>interface-id</i>] [<i>ra-info</i>]] [brief [<i>interface-id</i>]] |
| Displays neighbor information. | show ipv6 neighbors [verbose] [<i>interface-id</i>] [<i>ipv6-address</i>] [static] |

Debugging

 System resources are occupied when debugging information is output. Therefore, disable the debugging switch immediately after use.

| Description | Command |
|---------------------------|----------------------|
| Debugs ND entry learning. | debug ipv6 nd |

4 Configuring DHCP

4.1 Overview

The Dynamic Host Configuration Protocol (DHCP) is a LAN protocol based on the User Datagram Protocol (UDP) for dynamically assigning reusable network resources, for example, IP addresses.

The DHCP works in Client/Server mode. A DHCP client sends a request message to a DHCP server to obtain an IP address and other configurations. When a DHCP client and a DHCP server are not in a same subnet, they need a DHCP relay to forward DHCP request and reply packets.

Protocols and Standards

- RFC2131: Dynamic Host Configuration Protocol
- RFC2132: DHCP Options and BOOTP Vendor Extensions
- RFC3046: DHCP Relay Agent Information Option

4.2 Applications

| Application | Description |
|--|--|
| Providing DHCP Service in a LAN | Assigns IP addresses to clients in a LAN. |
| Enabling DHCP Client | Enable DHCP Client. |
| Applying AM Rule on DHCP Server | Apply DHCP Server in Super VLAN environment. |
| Deploying DHCP Relay in WLAN | In a WLAN, users from different network segments requests IP addresses. |
| Applying AM Rule on DHCP Relay | In a Super VLAN, users from different network segments requests IP addresses. |
| Assigning DNS Addresses Obtained from External DHCP Server | In a WLAN, assign preferentially DNS addresses obtained from external DHCP server in WLAN. |

4.2.1 Providing DHCP Service in a LAN

Scenario

Assign IP addresses to four users in a LAN.

For example, assign IP addresses to User 1, User 2, User 3 and User 4, as shown in the following figure.

- The four users are connected to Server S through A, B, C and D.

Figure 4-1

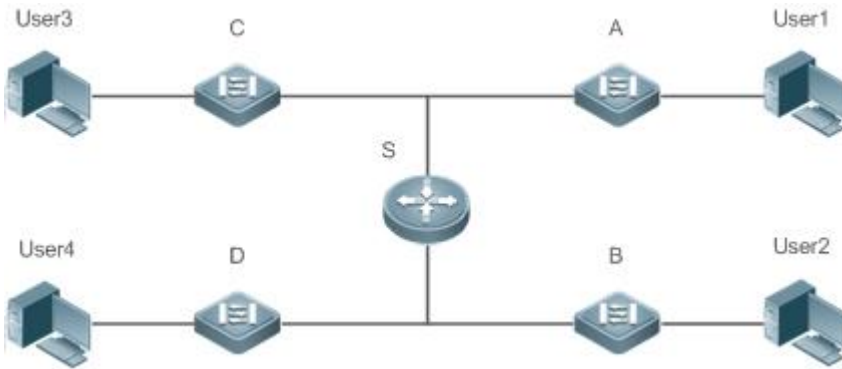

| | |
|----------------|--|
| Remarks | <p>S is an egress gateway working as a DHCP server.</p> <p>A, B, C and D are access switches achieving layer-2 transparent transmission.</p> <p>User 1, User 2, User 3 and User 4 are LAN users.</p> |
|----------------|--|

Deployment

- Enable DHCP Server on S.
- Deploy layer-2 VLAN transparent transmission on A, B, C and D.
- User 1, User 2, User 3 and User 4 initiate DHCP client requests.

4.2.2 Enabling DHCP Client

Scenario

Access switches A, B, C and D in a LAN request server S to assign IP addresses.

For example, enable DHCP Client on the interfaces of A, B, C and D to request IP addresses, as shown in the following figure.

Figure 4-2

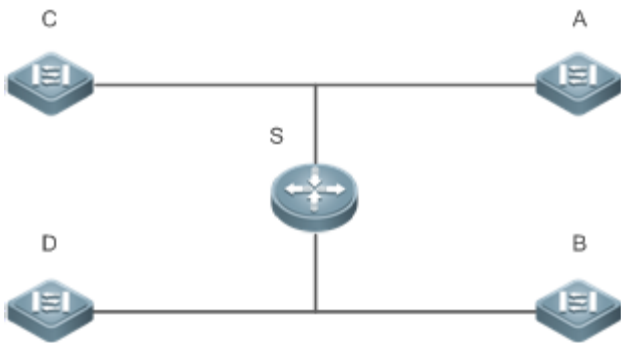

| | |
|----------------|---|
| Remarks | S is an egress gateway working as a DHCP server. A, B, C and D are access switches with DHCP Client enabled on the interfaces. |
|----------------|---|

Deployment

- Enable DHCP Server on S.
- Enable DHCP Client on the interfaces of A, B, C and D.

4.2.3 Applying AM Rule on DHCP Server

Scenario

As shown in Figure 4-3, create a Super VLAN, configure an AM rule and enable DHCP Server on the core switch A. B is an aggregation switch, C an access switch, and D a wireless access device. The requirements are listed as follows:

- Assign IP addresses dynamically based on the VLAN and port;
- Assign IP addresses statically based on the VLAN;
- Assign IP addresses dynamically based on the default AM rule.

Figure 4-3 Applying AM Rule on a DHCP Server

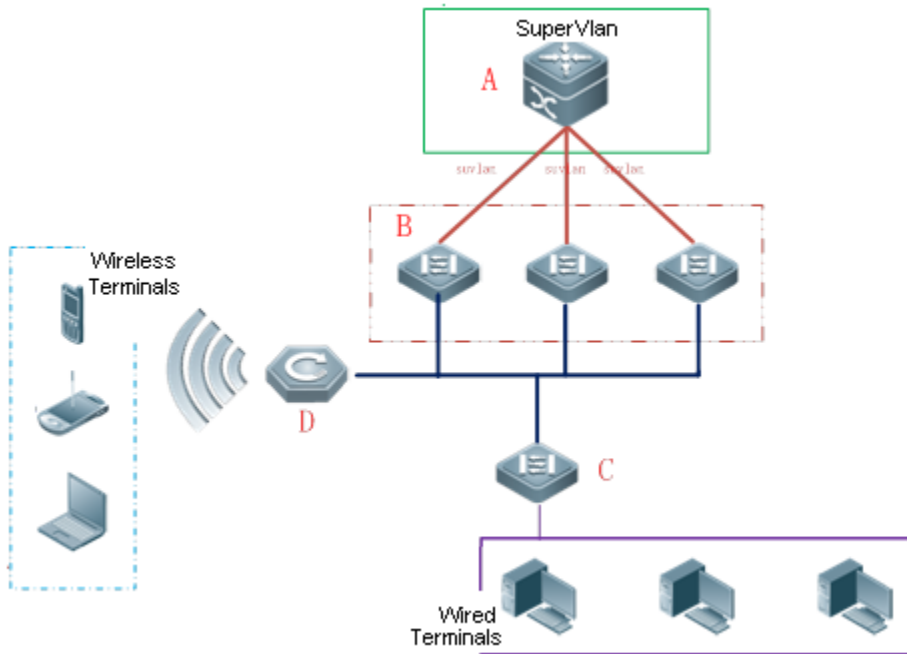

| | |
|----------------|---|
| Remarks | A is a core device. B is an aggregation device. C is a wired access device. D is a wireless access device. |
|----------------|---|

Deployment

- Configure an AM rule, enable DHCP Server and create a Super VLAN on A.
- Create VLANs on B and C to transparently transmit DHCP packets from wired users to A to request IP addresses.
- Enable the wireless function on D to transparently transmit DHCP packets from wireless users to A to request IP addresses.

4.2.4 Deploying DHCP Relay in WLAN

Scenario

Wireless users in different network segments obtain IP addresses to access the Internet.

Figure 4-4 DHCP Relay

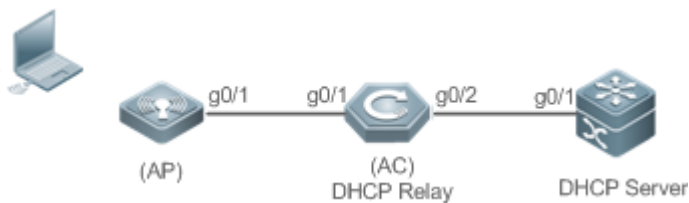

| | |
|----------------|---|
| Remarks | <p>AP is a wireless access point.</p> <p>AC is a wireless management device and DHCP Relay agent.</p> <p>DHCP Server is a core device responsible for assigning IP addresses to wireless users.</p> |
|----------------|---|

Deployment

- Connect AP to AC.
- Enable DHCP Relay on AC.
- Enable DHCP Server on the core device.

4.2.5 Applying AM Rule on DHCP Relay

Scenario

As shown in Figure 4-5, A is a DHCP server, B a core switch configured with Super VLAN, an AM rule and DHCP Relay, C an aggregation switch, D an access switch, and E a wireless access device. The requirements are listed as follows:

- Based on the VLAN-port AM rule, the DHCP relay agent chooses a subnet address as Giaddress of relay packets and forwards them to the DHCP server to request an IP address for the client.
- Based on default AM rule, the DHCP relay agent chooses a subnet address as Giaddress of relaying packets and forwards them to the DHCP server to request an IP address for the client.

Figure 4-5 Applying AM Rule on DHCP Relay

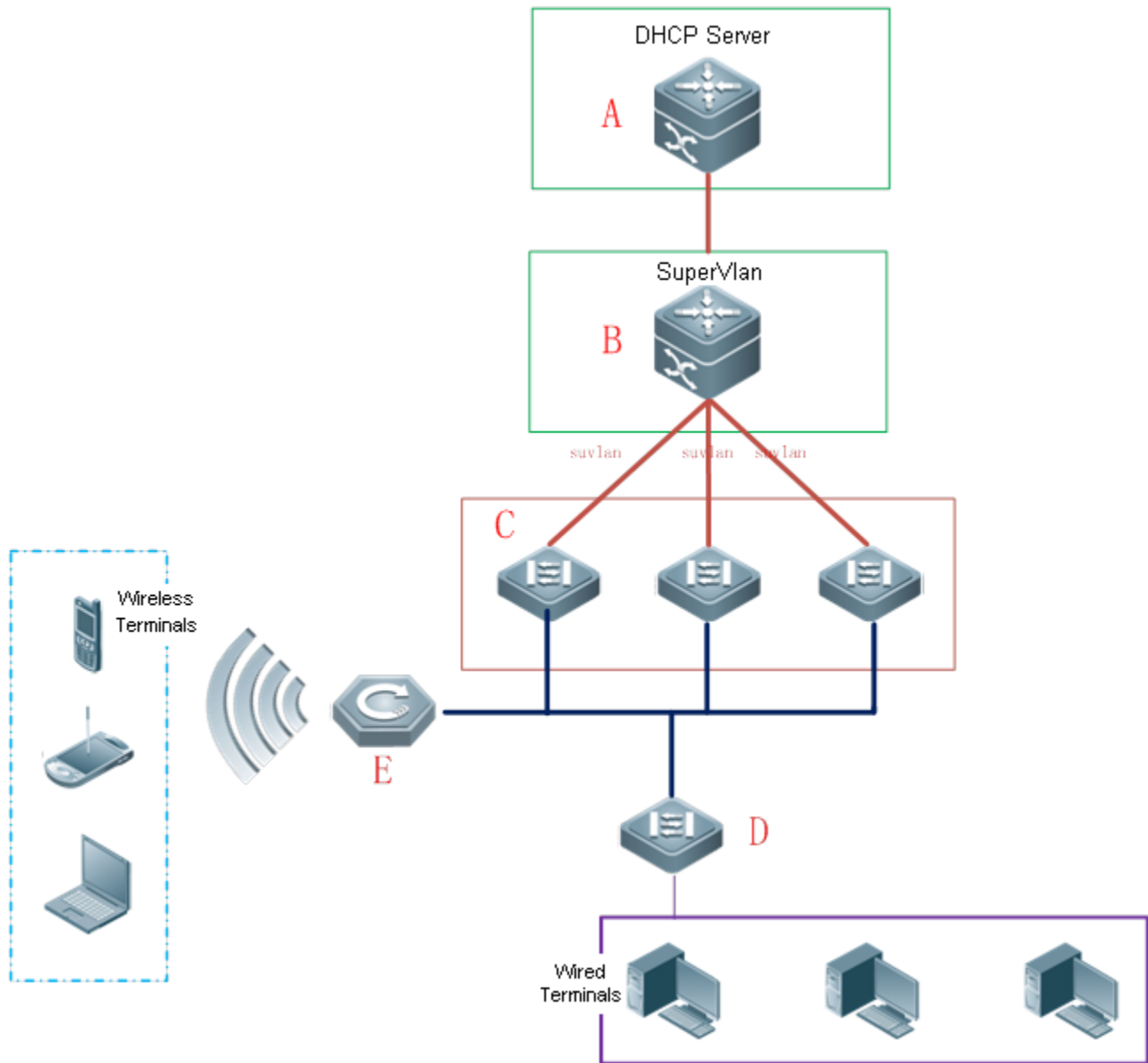

| | |
|----------------|---|
| Remarks | <p>A is a core device.</p> <p>B is a core device.</p> <p>C is an aggregation device.</p> <p>D is a wired access device.</p> <p>E is a wireless access device.</p> |
|----------------|---|

Deployment

- Enable DHCP Server on A.
- Configure an AM rule, enable DHCP Relay and create a Super VLAN on B.
- Create VLANs on C and D to transparently transmit DHCP packets from wired users to B to request IP addresses.

- Enable the wireless function on E to transparently transmit DHCP packets from wireless users to B to request IP addresses.

4.2.6 Assigning Preferentially DNS Addresses Obtained from External DHCP Server in WLAN

Scenario

When the WAN port of a wireless fat AP operates in PPPoE or DHCP Client mode, a DNS address can be automatically obtained from an external DHCP server and be configured on the DHCP server of the local device, so that the user does not need to perform DNS configuration. When the fat AP serves as the DHCP server, it preferentially assigns STAs with DNS addresses obtained from an external DHCP server.

Figure 4-6 DHCP Server Network Topology

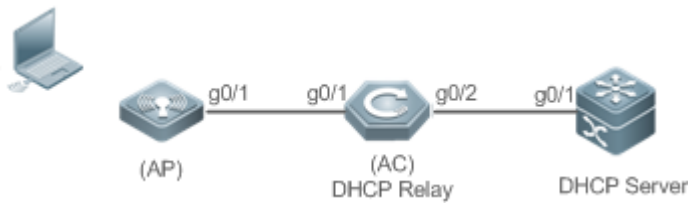

| | |
|----------------|---|
| Remarks | When an AP operates in fat AP mode, and the WAN port of the fat AP operates in PPPoE or DHCP Client mode, the AP can obtain IP addresses and DNS addresses from an external DHCP server, and serves as the DHCP server to assign addresses to STAs. |
|----------------|---|

Deployment

- Configure the AP as a fat AP and enable the PPPoE or DHCP Client function on the WAN port of the fat AP.
- Enable the DHCP server function on the fat AP to assign addresses to STAs.
- Preferentially assign DNS addresses obtained by the PPPoE or DHCP Client module from an external DHCP server to STAs.

4.3 Features

Basic Concepts

↘ DHCP Server

Based on the RFC 2131, Ruijie DHCP server assigns IP addresses to clients and manages these IP addresses.

↘ DHCP Client

DHCP Client enables a device to automatically obtain an IP address and configurations from a DHCP server.

↘ DHCP Relay

When a DHCP client and a DHCP server are not in a same subnet, they need a DHCP relay to forward DHCP request and reply packets.

↘ Lease

Lease is a period of time specified by a DHCP server for a client to use an assigned IP address. An IP address is active when leased to a client. Before a lease expires, a client needs to renew the lease through a server. When a lease expires or is deleted from a server, the lease becomes inactive.

↘ Excluded Address

An excluded address is a specified IP address not assigned to a client by a DHCP server.

↘ Address Pool

An address pool is a collection of IP addresses that a DHCP server may assign to clients.

↘ Option Type

An option type is a parameter specified by a DHCP server when it provides lease service to a DHCP client. For example, a public option include the IP addresses of a default gateway (router), WINS server and a DNS server. DHCP server allows configuration of other options. Though most options are defined in the RFC 2132, you can add user-defined options.

Overview

| Feature | Description |
|----------------------------------|---|
| DHCP Server | Enable DHCP Server on a device, and it may assign IP addresses dynamically and pushes configurations to DHCP clients. |
| DHCP Relay Agent | Enable DHCP Relay on a device, and it may forward DHCP request and reply packets across different network segments. |
| DHCP Client | Enable DHCP Client on a device, and it may obtain IP addresses and configurations automatically from a DHCP server. |
| AM Rule | Enable an AM rule on a device, and it may assign IP addresses according to the rule. |

4.3.1 DHCP Server

Working Principle

↘ DHCP Working Principle

Figure 4-7

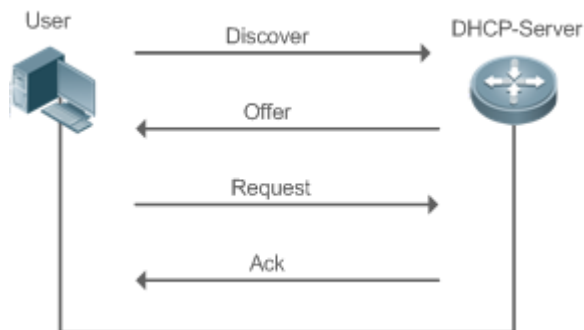

A host requests an IP address through DHCP as follows:

1. A host broadcasts a DHCP discover packet to find DHCP servers in a network.
2. DHCP servers unicast/broadcast (based on the property of the host packet) DHCP offer packets to the host, containing an IP address, a MAC address, a domain name and a lease.
3. The host broadcasts a DHCP request packet to formally request an IP address.
4. A DHCP server sends a DHCP ACK unicast packet to the host to acknowledge the request.

i A DHCP client may receive DHCPOFFER packets from multiple DHCP servers, but usually it accepts only the first DHCPOFFER packet. Besides, the address specified in a DHCPOFFER packet is not necessarily assigned. Instead, it is retained by the DHCP server until a client sends a formal request.

To formally request an IP address, a client broadcasts a DHCPREQUEST packet so that all DHCP servers sending DHCPOFFER packets may receive the packet and release OFFER IP addresses.

If a DHCPOFFER packet contains invalid configuration parameters, a client will send a DHCPDECLINE packet to the server to decline the configuration.

During the negotiation, if a client does not respond to the DHCPOFFER packets in time, servers will send DHCPNAK packets to the client and the client will reinitiate the process.

During network construction, Ruijie DHCP servers have the following features:

- Low cost. Usually the static IP address configuration costs more than DHCP configuration.
- Simplified configuration. Dynamic IP address assignment dramatically simplifies device configuration
- Centralized management. You can modify the configuration for multiple subnets by simply modifying the DHCP server configuration.

▾ Address Pool

After a server receives a client's request packet, it chooses a valid address pool, determines an available IP address from the pool through PING, and pushes the pool and address configuration to the client. The lease information is saved locally for validity check upon lease renewal.

An address pool may carry various configuration parameters as follows:

- An IP address range, which is the range of IP addresses that are available.
- A gateway address. A maximum of 8 gateway addresses are supported.

- A DNS address. A maximum of 8 DNS addresses are supported.
- A lease period notifying clients of when to age an address and request a lease renewal.

↘ VRRP Monitoring

In a Virtual Router Redundancy Protocol (VRRP) scenario, Ruijie devices enabled with DHCP provide a command to monitor the VRRP status of the interface. To an interface configured with VRRP address and VRRP monitoring, a DHCP server only processes the DHCP clients' request packets from the interface in Master state, and other packets are discarded. If no VRRP address is configured, the DHCP server does not monitor the VRRP status, and all DHCP packets are processed. VRRP monitoring is configured on only layer-3 interfaces. It is disabled by default, namely, only the Master device processes the DHCP service.

↘ IP Address Assignment Based on VLANs, Ports and IP Range

After an IP address pool is deployed, the specified IP address range is assigned based on VLANs and ports. There are three scenarios. 1. Global configuration. 2. Configuration based on VLANs, ports and IP range. 3. Both 1 and 2. In scenario 1, the addresses are assigned globally. In scenario 2, the addresses in the specified IP range are assigned only to the clients of the specified VLANs and ports. In scenario 3, the clients of the specified VLANs and ports are assigned the addresses in the specified IP range, and the other clients are configured with default global addresses.

↘ Adding Trusted ARP

A trusted ARP prevents gateway ARP spoofing. Ruijie devices enabled with DHCP provide a command for pushing a trusted ARP while assigning an address. After this function is enabled, DHCP server pushes it while assigning an IP address to the client to prevent ARP spoofing.

↘ ARP-Based Offline Detection

Ruijie devices enabled with DHCP provide a command to enable ARP-based offline detection. After this function is enabled, a DHCP server will receive an ARP aging notification when a client gets offline, and start retrieving the client's address. If the client does not get online within a period of time (5 minutes by default), the DHCP server will retrieve the address and assign it to another client. If the client gets online again, the address is still valid.

↘ Adding Pseudo Server Detection

If a DHCP server is deployed illegally, a client interacts with this server while requesting an IP address and a wrong address will be assigned to the client. This server is a pseudo server. Ruijie devices enabled with DHCP provides a command to enable pseudo server detection. After it is enabled, DHCP packets are checked for Option 54 (Server Identifier Option). If the content of Option 54 is different from the actual DHCP server identifier, the IP address of the pseudo server and port receiving the packets will be recorded. The pseudo server detection is only an after-event security function and cannot prevent an illegal DHCP server from assigning IP addresses to clients.

Related Configuration

↘ Enabling DHCP Server Globally

- By default, DHCP Server is disabled.

- Run the **service dhcp** command to enable the DHCP Server.
- Run the **service dhcp** command globally to enable DHCP service.

📌 Configuring Address Pool

- By default, no address pool is configured.
- Run the **ip dhcp pool** command to configure an IP address range, a gateway and a DNS.
- If no address pool is configured, no addresses will be assigned.

4.3.2 DHCP Relay Agent

Working Principle

The destination IP address of DHCP request packets is 255.255.255.255, and these packets are forwarded within a subnet. To achieve IP address assignment across network segments, a DHCP relay agent is needed. The DHCP relay agent unicasts DHCP request packets to a DHCP server and forwards DHCP reply packets to a DHCP client. The DHCP relay agent serves as a repeater connecting a DHCP client and a DHCP server of different network segments by forwarding DHCP request packets and DHCP reply packets. The Client-Relay-Server mode achieves management of IP addresses across multiple network segments by only one DHCP server. See the following figure.

Figure 4-8 DHCP Relay Scenario

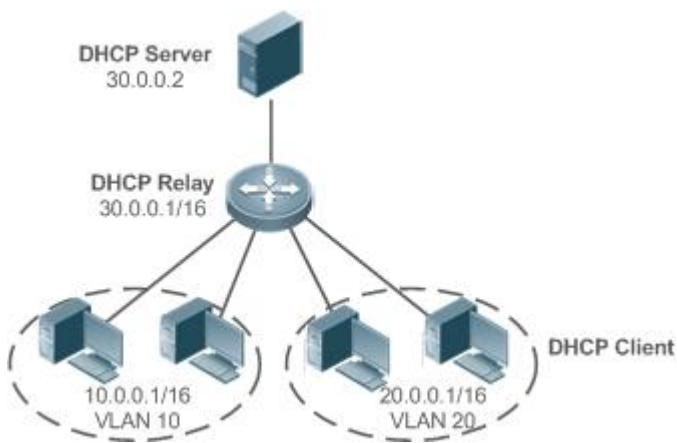

VLAN 10 and VLAN 20 correspond to the segments 10.0.0.1/16 and 20.0.0.1/16 respectively. A DHCP server with IP address 30.0.0.2 is in segment 30.0.0.1/16. To achieve management of dynamic IP addresses in VLAN 10 and VLAN 20 by the DHCP server, you only need to enable DHCP Relay on a gateway and configure IP address 30.0.0.2 for the DHCP server.

📌 DHCP Relay Agent Information (Option 82)

As defined in RFC3046, an option can be added to indicate a DHCP client's network information when DHCP Relay is performed, so that a DHCP server may assign IP addresses of various privileges based on more accurate information. The option is called Option 82. Currently, Ruijie devices support four schemes of relay agent information, which are described respectively as follows:

- a) Relay agent information option82: This scheme serves without correlation with other protocol modules. A DHCP relay agent forms an Option 82 based on the physical port receiving DHCP request packets and the MAC address of the device. The option format is shown in the following figure.

Figure 4-9 Agent Circuit ID

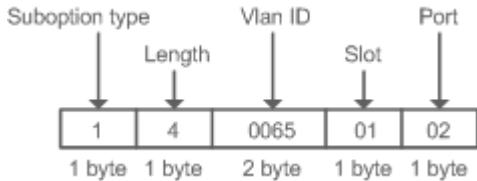
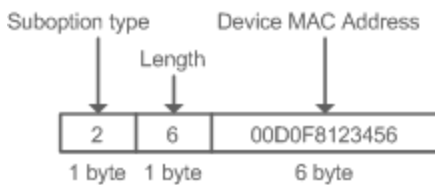

Figure 4-10 Agent Remote ID



📌 DHCP Relay Check Server-ID

In DHCP environment, multiple DHCP servers are deployed for a network, achieving server backup to ensure uninterrupted network operation. After this function is enabled, the DHCP request packet sent by a client contains a **server-id** option specifying a DHCP server. In alleviating the burden on servers in specific environments, you need to enable this function on a relay agent to send a packet to a specified DHCP server rather than all DHCP servers.

📌 DHCP Relay suppression

After you configure the **ip DHCP Relay suppression** command on an interface, DHCP request packets received on the interface will be filtered, and the other DHCP request packets will be forwarded.

Related Configuration

📌 Enabling DHCP Relay

- By default, DHCP Relay is disabled.
- You may run the **service dhcp** command to enable DHCP Relay.
- You need to enable DHCP Relay before it works.

📌 Configuring IP Address for DHCP Server

- By default, no IP address is configured for a DHCP server.
- You may run the **ip helper-address** command to configure an IP address for a DHCP server. The IP address can be configured globally or on a layer-3 interface. A maximum of 20 IP addresses can be configured for a DHCP server.

📌 Enabling DHCP Option 82

- By default, DHCP Option 82 is disabled.

- You may run the **ip dhcp relay information option82** command to enable DHCP Option 82.

↳ Enabling DHCP Relay Check Server-ID

- By default, DHCP Relay check server-id is disabled.
- You may run the **ip dhcp relay check server-id** command to enable DHCP Relay check server-id.

↳ Enabling DHCP Relay Suppression

- By default, DHCP Relay suppression is disabled on all interfaces.
- You may run the **ip dhcp relay suppression** command to enable it on an interface.

4.3.3 DHCP Client

Working Principle

A DHCP client broadcasts a DHCP discover packet after entering the Init state. Then it may receive multiple DHCP offer packets. It chooses one of them and responds to the corresponding DHCP server. After that, it sends lease renewal request packets in the Renew and Rebind processes of an aging period to request lease renewal.

Related Configuration

↳ Enabling DHCP Client on Interface

- By default, DHCP Client is disabled.
- In interface configuration mode, you may run the **ip address dhcp** command to enable DHCP Client.
- You need to enable DHCP Client to enable DHCP service.
- The configuration takes effect on a layer-3 interface, for example, an SVI or a routed port.

4.3.4 AM Rule

Working Principle

An AM rule defines the range of IP addresses assigned to DHCP clients in different VLANs and ports. It can be used to quickly identify the VLAN and port of a faulty DHCP client and effectively assign addresses. After an AM rule is configured, all DHCP clients from the set VLAN and ports may obtain IP addresses. If no AM rule is configured, there are two following cases: If a default AM rule is configured, the client obtains an IP address from the default range; if no default AM rule is configured, the client cannot obtain an IP address.





Related Configuration

↳ Configuring AM Rule in Global Configuration Mode

- In global configuration mode, run the **address-manage** command to enter AM rule configuration mode.
- Run the **match ip default** command to configure a default AM rule.
- Run the **match ip** command to configure an AM rule based on VLAN & port or port.





4.4 Configuration

↳ Configuring DHCP Server

| Configuration | Description and Command | |
|--|--|---|
| Configuring Dynamic IP Address |  (Mandatory) It is used to enable DHCP Server to achieve dynamic IP address assignment. | |
| | service dhcp | Enables DHCP Server. |
| | ip dhcp pool | Configures an address pool. |
| | network | Configures the network number and subnet mask of a DHCP address pool. |
| |  (Optional) It is used to configure the properties of an address pool. | |
| | default-router | Configures a default gateway of a client. |
| | lease | Configures an address lease. |
| | next-server | Configures a TFTP server address |
| | bootfile | Configures a boot file of a client. |
| | domain-name | Configures a domain name of a client. |
| | dns-server | Configures a domain name server. |
| | netbios-name-server | Configures a NetBIOS WINS server. |
| | netbios-node-type | Configures a NetBIOS node type on a client. |
| | lease-threshold | Configures an alarm threshold of an address pool. |
| | option | Configures a user-defined option. |
| | pool-status | Enables or disables an address pool. |
| update arp | Adds a trusted ARP while assigning addresses from a pool. | |
| Configuring Static IP Address |  (Optional) It is used to statically assign an IP address to a client. | |
| | ip dhcp pool | Configures an address pool name and enters address pool configuration mode. |
| | host | Configures the IP address and subnet mask of a client host. |
| | hardware-address | Configures a client hardware address. |
| | client-identifier | Configures a unique client identifier. |
| | client-name | Configures a client name. |
| Configuring Global Properties of DHCP Server |  (Optional) It is used to configure the properties of a DHCP server. | |
| | ip dhcp excluded-address | Configures an excluded IP address. |
| | ip dhcp force-send-nak | Configures Compulsory NAK reply by a DHCP server. |

| Configuration | Description and Command | |
|---|--|---|
| | ip dhcp monitor-vrrp-state | Configures VRRP status monitoring. |
| | ip dhcp ping packets | Configures ping times. |
| | ip dhcp ping timeout | Configures a ping timeout. |
| | ip dhcp refresh arp | Configures a DHCP server to refresh trusted ARPs. |
| | ip dhcp server arp-detect | Configures a DHCP server to detect user offline. |
| | ip dhcp server detect | Configures pseudo server detection. |
| Configuring AM Rule for DHCP Server |  (Optional) It is used to configure the AM rule of a DHCP server. | |
| | address-manage | Enters AM configuration mode. |
| | match ip default | Configures a default AM rule. |
| | match ip | Configures AM rule based on VLAN/VLAN and port. |

↘ Configuring DHCP Relay

| Configuration | Description and Command | |
|--|--|--|
| Configuring Basic DHCP Relay Functions |  (Mandatory) It is used to enable DHCP Relay. | |
| | service dhcp | Enables DHCP Relay. |
| | ip helper-address | Configures an IP Address of a DHCP Server. |
| Configuring DHCP Relay Option 82 |  (Optional) It is used to assign IP addresses of different privileges to clients in combination with the information of a physical port. This function cannot be used together with the dhcp option dot1x command. | |
| | ip dhcp relay information option82 | Enables DHCP option82. |
| Configuring DHCP Relay Check Server-ID |  (Optional) It is used to enable a DHCP Relay agent to send DHCP request packets only to a specified server. | |
| | ip dhcp relay check server-id | Enables a DHCP Relay agent to send DHCP request packets only to a specified server |
| Configuring DHCP Relay Suppression |  (Optional) It is used to shield DHCP request packets on an interface. | |
| | ip dhcp relay suppression | Enables DHCP Relay Suppression. |

↘ Configuring DHCP Client

| Configuration | Description and Command |
|---|--|
| Configuring DHCP Client |  (Mandatory) It is used to enable DHCP Client. |
| | ip address dhcp <p>Enables an Ethernet interface, a PPP/HDLC-encapsulated or FR-encapsulated interface to obtain IP addresses through DHCP.</p> |

4.4.1 Configuring Dynamic IP Address

Configuration Effect

Provide all DHCP clients with DHCP service including assigning IP addresses and gateways.

Notes

A DHCP server and a DHCP relay share the **service dhcp** command, but a device cannot function as a DHCP server and relay at the same time. When a device is configured with a valid address pool, it acts as a server and forwards packets. Otherwise, it serves as a relay agent.

Configuration Steps

↘ Enabling DHCP Server

- Mandatory. It achieves dynamic IP address assignment.
- Run the **service dhcp** command in global configuration mode.

↘ Configuring Address Pool

- Mandatory. It is used to create an IP address pool.
- Run the **ip dhcp pool** command in global configuration mode.

↘ Configuring Network Number and Subnet Mask of DHCP Address Pool

- Mandatory. It defines a range of dynamically assigned addresses.
- Run the **network** command in DHCP address pool configuration mode.

↘ Configuring Default Gateway of Client

- Optional. It is used to configure a gateway address.
- Run the **default-router** command in DHCP address pool configuration mode.

↘ Configuring Address Lease

- Optional. It is used to configure an IP address lease, which is 24h by default.
- Run the **lease** command in DHCP address pool configuration mode.

↘ **Configuring TFTP Server Address**

- Optional. It is used to configure a TFTP server address.
- Run the **next-server** command in DHCP address pool configuration mode.

↘ **Configuring Domain Name of Client**

- Optional. It is used to configure the domain name of a client.
- Run the **domain-name** command in DHCP address pool configuration mode.

↘ **Configuring DNS**

- Optional. It is used to configure a DNS address.
- Run the **dns** command in DHCP address pool configuration mode.

↘ **Configuring NetBIOS WINS Server**

- Optional. It is used to configure a NetBIOS WINS server address.
- Run the **netbios-name-server** command in DHCP address pool configuration mode.

↘ **Configuring NetBIOS Node Type on Client**

- Optional. It is used to configure a NetBIOS node type.
- Run the **netbios-name-type** command in DHCP address pool configuration mode.

↘ **Configuring Alarm Threshold of Address Pool**

- Optional. It is used to manage the number of leases. When a threshold (90% by default) is reached, an alarm will be printed.
- Run the **lease-threshold** command in DHCP address pool configuration mode.

↘ **Configuring User-Defined Option**

- Optional. It is used to configure user-defined options.
- Run the **option** command in DHCP address pool configuration mode.

↘ **Enabling or Disabling Address Pool**

- Optional. It is used to enable or disable an address pool. It is enabled by default.
- Run the **pool-status** command in DHCP address pool configuration mode.

↘ **Adding Trusted ARP**

- Optional. It is used to add a trusted ARP while assigning an IP address. It is disabled by default.
- Run the **update arp** command in DHCP address pool configuration mode.

Verification

Connect a DHCP client and a DHCP server.

- Check whether the client obtains configurations on the server.

Related Commands

↳ Enabling DHCP Server

| | |
|------------------------------|--|
| Command | service dhcp |
| Parameter Description | N/A |
| Command Mode | Global configuration mode |
| Usage Guide | Enable DHCP Server and DHCP Relay. A DHCP server and a DHCP relay share the service dhcp command. When a device is configured with a valid address pool, it acts as a server and forwards packets. Otherwise, it serves as a relay agent. |

↳ Configuring Address Pool

| | |
|------------------------------|--|
| Command | ip dhcp pool <i>dhcp-pool</i> |
| Parameter Description | <i>pool-name</i> : Indicates the name of an address pool. |
| Command Mode | Global configuration mode |
| Usage Guide | Before assigning an IP address to a client, you need to configure an address pool name and enter DHCP address pool configuration mode. |

↳ Configuring Network Number and Subnet Mask of DHCP Address Pool

| | |
|------------------------------|---|
| Command | network <i>network-number mask [low-ip-address high-ip-address]</i> |
| Parameter Description | <i>network-number</i> : Indicates the network number of an IP address pool. <i>mask</i> : Indicates the subnet mask of an IP address pool. If no subnet mask is defined, the natural subnet mask is applied. |
| Command Mode | DHCP address pool configuration mode |
| Usage Guide | To configure dynamic address assignment, you need to configure a network number and subnet mask of an address pool to provide a DHCP server with a range of addresses. The IP addresses in a pool are assigned in order. If an address is assigned or exists in the target network segment, the next address will be checked until a valid address is assigned. Ruijie wireless products provide available network segments by specifying start and end addresses. The configuration is optional. If the start and end address are not specified, all IP addresses in the network segment are assignable. For Ruijie products, addresses are assigned based on the client's physical address and ID. Therefore, one client will not be assigned two leases from one address pool. In case of topological redundancy between a client and a server, address assignment may fail. |

To avoid such failures, a network administrator needs to prevent path redundancy in network construction, for example, by adjusting physical links or network paths.

↘ Configuring Default Gateway of Client

| | |
|------------------------------|---|
| Command | default-router <i>address</i> [<i>address2</i> ... <i>address8</i>] |
| Parameter Description | <i>address</i> : Indicates the IP address of a default gateway. Configure at least one IP address. <i>ip-address2</i> ... <i>ip-address8</i> : (Optional) A maximum of 8 gateways can be configured. |
| Command Mode | DHCP address pool configuration mode |
| Usage Guide | Configure a default gateway of a client, and a server will push the gateway configuration to the client. The IP addresses of the default gateway and the client should be in a same network. |

↘ Configuring Address Lease

| | |
|------------------------------|---|
| Command | lease { <i>days</i> [<i>hours</i>] [<i>minutes</i>] infinite } |
| Parameter Description | <i>days</i> : Defines a lease in the unit of day. <i>hours</i> : (Optional) Defines a lease in the unit of hour. Please define <i>days</i> before <i>hours</i> . <i>minutes</i> : (Optional) Defines a lease in the unit of minute. Please define <i>days</i> and <i>hours</i> before <i>minutes</i> . infinite : Defines an unlimited lease. |
| Command Mode | DHCP address pool configuration mode |
| Usage Guide | The default lease of an IP address assigned by a DHCP server is 1 day. When a lease is expiring soon, a client needs to request a lease renewal. Otherwise the IP address cannot be used after the lease is expired. |

↘ Configures Boot File on Client

| | |
|------------------------------|---|
| Command | bootfile <i>filename</i> |
| Parameter Description | <i>file-name</i> : Defines a boot file name. |
| Command Mode | DHCP address pool configuration mode |
| Usage Guide | A boot file is a bootable image file used when a client starts up. The file is usually an OS downloaded by a DHCP client. |

↘ Configuring Domain Name of Client

| | |
|------------------------------|---|
| Command | domain-name <i>domain</i> |
| Parameter Description | <i>domain-name</i> : Defines a domain name of a DHCP client. |
| Command Mode | DHCP address pool configuration mode |
| Usage Guide | You may define a domain name for a client. When the client accesses network through the host name, the domain name will be added automatically to complete the host name. |

▾ Configuring DNS

| | |
|---------------------|--|
| Command | dns-server <i>ip-address</i> [<i>ip-address2</i> ... <i>ip-address8</i>] |
| Parameter | <i>ip-address</i> : Defines an IP address of a DNS server. Configure at least one IP address. |
| Description | <i>ip-address2</i> ... <i>ip-address8</i> : (Optional) A maximum of 8 DNS servers can be configured. use-dhcp-client <i>interface-type interface-number</i> : A DHCP client learns its DNS server via RGOS software. |
| Command Mode | DHCP address pool configuration mode |
| Usage Guide | If a client accesses network resources through the domain name, you need to configure a DNS server to resolve the domain name. |

▾ Configuring NetBIOS WINS Server

| | |
|---------------------|---|
| Command | netbios-name-server <i>address</i> [<i>address2</i> ... <i>address8</i>] |
| Parameter | <i>address</i> : Defines an IP address of a WINS server. Configure at least one IP address. |
| Description | <i>ip-address2</i> ... <i>ip-address8</i> : (Optional) A maximum of 8 WINS servers can be configured. |
| Command Mode | DHCP address pool configuration mode |
| Usage Guide | WINS is a domain name service through which a Microsoft TCP/IP network resolves a NetNBIO name to an IP address. A WINS server is a Windows NT server. When a WINS server starts, it receives a registration request from a WINS client. When the client shuts down, it sends a name release message, so that the computers in the WINS database and on the network are consistent. |

▾ Configuring NetBIOS Node Type on Client

| | |
|---------------------|--|
| Command | netbios-node-type <i>type</i> |
| Parameter | <i>type</i> : Defines a NetBIOS node type with one of the following approaches. |
| Description | <ol style="list-style-type: none"> 1. A hexadecimal number, ranging from 0 to FF. Only followings values are available. <ul style="list-style-type: none"> ● b-node ● p-node ● m-node ● 8 for h-node 2. A character string. <ul style="list-style-type: none"> ● b-node for a broadcast node; ● p-node for a peer-to-peer node; ● m-node for a mixed node; ● h-node for a hybrid mode. |
| Command Mode | DHCP address pool configuration mode |
| Usage Guide | There are four types of NetBIOS nodes of a Microsoft DHCP client. 1) A broadcast node. For such a node, NetBIOS name resolution is requested through broadcast.2) A peer-to-peer node. The client sends a resolution request to the WINS server. 3) A mixed node. The client broadcasts a resolution request and sends the resolution request to the WINS server.. 4) A hybrid node. The client sends a resolution request to |

| | |
|--|--|
| | the WINS server. If no reply is received, the client will broadcast the resolution request. By default, a Microsoft operating system is a broadcast or hybrid node. If no WINS server is configured, it is a broadcast node. Otherwise, it is a hybrid node. |
|--|--|

↘ Configuring User-Defined Option

| | |
|------------------------------|---|
| Command | option <i>code</i> { ascii <i>string</i> hex <i>string</i> ip <i>ip-address</i> } |
| Parameter Description | <i>code</i> : Defines a DHCP option code. ascii <i>string</i> : Defines an ASCII character string. hex <i>string</i> : Defines a hexadecimal character string. ip <i>ip-address</i> : Defines an IP address. |
| Command Mode | DHCP address pool configuration mode |
| Usage Guide | The DHCP allows transmitting configuration information to a host via a TCP/IP network. DHCP packets contain the option field of definable content. A DHCP client should be able to receive a DHCP packet carrying at least 312 bytes option. Besides, the fixed data field in a DHCP packet is also called an option. In a WLAN, a DHCP client on an AP dynamically requests the IP address of an AC. You may configure on a DHCP server the option command specifying the AC address. |

↘ Enabling or Disabling Address Pool

| | |
|------------------------------|--|
| Command | pool-status { enable disable } |
| Parameter Description | enable : Enables an address pool. disable : Disable an address pool. It is enabled by default. |
| Command Mode | DHCP address pool configuration mode |
| Usage Guide | A Ruijie wireless product provides a command for you to enable/disable a DHCP address pool. |

↘ Adding Trusted ARP

| | |
|------------------------------|---|
| Command | update arp |
| Parameter Description | N/A |
| Command Mode | DHCP address pool configuration mode |
| Usage Guide | After configuration, a trusted ARP is added when an address is assigned from a pool. A trusted ARP prevents ARP spoofing. |

Configuration Example

↘ Configuring Address Pool

| | |
|----------------------|--|
| Configuration | <ul style="list-style-type: none"> Define an address pool net172. |
|----------------------|--|

| | |
|---------------------|--|
| Steps | <ul style="list-style-type: none"> ● The network segment is 172.16.1.0/24. ● The default gateway is 172.16.1.254. ● The address lease is 1 day. ● xcluded addresses range from 172.16.1.2 to 172.16.1.100. |
| | <pre>Ruijie(config)# ip dhcp excluded-address 172.16.1.2 172.16.1.100 Ruijie(dhcp-config)# ip dhcp pool net172 Ruijie(dhcp-config)# network 172.16.1.0 255.255.255.0 Ruijie(dhcp-config)# default-router 172.16.1.254 Ruijie(dhcp-config)# lease 1</pre> |
| | |
| Verification | Run the show run command to display the configuration. |
| | <pre>Ruijie(config)#show run begin ip dhcp ip dhcp excluded-address 172.16.1.2 172.16.1.100 ip dhcp pool net172 network 172.16.1.0 255.255.255.0default-router 172.16.1.254 lease 1</pre> |

4.4.2 Configuring Static IP Address

Configuration Effect

Assign specific IP addresses and push configuration to specific DHCP clients.

Notes

N/A

Configuration Steps

▾ Configuring Address Pool Name and Entering Address Pool Configuration Mode

- Mandatory. It is used to create an IP address pool.
- Run the **ip dhcp pool** command in global configuration mode.

▾ Configuring IP Address and Subnet Mask of Client

- Mandatory. It is used to configure a static IP address and a subnet mask.
- Run the **host** command in DHCP address pool configuration mode.

▾ Configuring Hardware Address of Client

- Optional. It is used to configure a MAC address.

- Run the **hardware** command in DHCP address pool configuration mode.

↘ Configures Unique Client Identifier

- Optional. It is used to configure a static user identifier (UID).
- Run the **client-identifier** command in DHCP address pool configuration mode.

↘ Configuring Client Name

- Optional. It is used to configure a static client name.
- Run the **host-name** command in DHCP address pool configuration mode.

Verification

Check whether the client obtains the IP address when it is online.

Related Commands

↘ Configuring Address Pool

| | |
|------------------------------|---|
| Command | ip dhcp pool <i>dhcp-pool</i> |
| Parameter Description | <i>pool-name</i> : Indicates the name of an address pool. |
| Command Mode | Global configuration mode |
| Usage Guide | Before assigning an IP address to a client, you need to configure an address pool name and enter address pool configuration mode. |

↘ Manual IP Address Binding

| | |
|------------------------------|---|
| Command | host <i>ip-address</i> [<i>netmask</i>] client-identifier <i>unique-identifier</i> client-name <i>name</i> |
| Parameter Description | <i>ip-address</i> : Defines the IP address of a DHCP client. <i>netmask</i> : Defines the subnet mask of a DHCP client. <i>unique-identifier</i> : Defines the hardware address (for example, aabb.bbbb.bb88) and identifier (for example, 01aa.bbbb.bbbb.88) of a DHCP client. <i>name</i> : (Optional) It defines a client name using ASCII characters. The name excludes a domain name. For example, name a host mary rather than mary.rg.com . |
| Command Mode | DHCP address pool configuration mode |
| Usage Guide | Address binding means mapping between an IP address and a client's MAC address. There are two kind of address binding. 1) Manual binding. Manual binding can be deemed as a special DHCP address pool with only one address. 2) Dynamic binding. A DHCP server dynamically assigns an IP address from a pool to a client when it receives a DHCP request, creating mapping between the IP address and the client's MAC address. |

To configure manual binding, you need to define a host pool and then specify a DHCP client's IP address and hardware address or identifier. A hardware address is a MAC address. A client identifier includes a network medium type and a MAC address. A Microsoft client is usually identified by a client identifier rather than a MAC address. For the codes of medium types, refer to the *Address Resolution Protocol Parameters* section in the RFC 1700. The Ethernet type is **01**.

Configuration Example

Dynamic IP Address Pool

| | |
|----------------------------|---|
| Configuration Steps | <ul style="list-style-type: none"> Configure address pool VLAN 1 with IP address 20.1.1.0 and subnet mask 255.255.255.0. The default gateway is 20.1.1.1. The lease time is 1 day. |
| | <pre>Ruijie(config)# ip dhcp pool vlan1 Ruijie(dhcp-config)# network 20.1.1.0 255.255.255.0 Ruijie(dhcp-config)# default-router 20.1.1.1 Ruijie(dhcp-config)# lease 1 0 0</pre> |
| Verification | <ul style="list-style-type: none"> Run the show run command to display the configuration. |
| | <pre>Ruijie(config)#show run begin ip dhcp ip dhcp pool vlan1 network 20.1.1.0 255.255.255.0 default-router 20.1.1.1 lease 1 0 0</pre> |

Manual Binding

| | |
|----------------------------|--|
| Configuration Steps | <ul style="list-style-type: none"> The host address is 172.16.1.101 and the subnet mask is 255.255.255.0. The host name is Billy.rg.com. The default gateway is 172.16.1.254. The MAC address is 00d0.df34.32a3. |
| | <pre>Ruijie(config)# ip dhcp pool Billy Ruijie(dhcp-config)# host 172.16.1.101 255.255.255.0 Ruijie(dhcp-config)# client-name Billy Ruijie(dhcp-config)# hardware-address 00d0.df34.32a3 Ethernet Ruijie(dhcp-config)# default-router 172.16.1.254</pre> |
| Verification | Run the show run command to display the configuration. |
| | <pre>Ruijie(config)#show run begin ip dhcp</pre> |

```
ip dhcp pool Billy
host 172.16.1.101 255.255.255.0
client-name Billy
hardware-address 00d0.df34.32a3 Ethernet
default-router 172.16.1.254
```

4.4.3 Configuring AM Rule for DHCP Server

Configuration Effect

Assign IP addresses according to an AM rule based on a port and a VLAN.

Notes

Ruijie products support AM rule configuration on Ethernet, GB, FR, PPP and HDLC interfaces.

Configuration Steps

▾ Configuring Address Management

- Mandatory. Enter address management mode.
- Run the **address-manage** command in address management configuration mode.

Verification

Check whether clients in different VLANs and ports obtain the valid IP addresses.

Related Commands

▾ Configuring Default Range

| | |
|---------------------|--|
| Command | match ip default <i>ip-address netmask</i> |
| Parameter | <i>ip-address</i> : Defines an IP address. |
| Description | <i>netmask</i> : Defines a subnet mask. |
| Command Mode | Address management mode |
| Usage Guide | After configuration, all DHCP clients are assigned IP addresses from the default range based on the VLAN and port. If this command is not configured, IP addresses will be assigned through the regular process. |

▾ Assigning Dynamic IP Address Based on VLAN and Port

| | |
|--------------------|--|
| Command | match ip <i>ip-address netmask interface</i> [add/remove] vlan <i>vlan-list</i> |
| Parameter | <i>ip-address</i> : Defines an IP address. |
| Description | <i>netmask</i> : Defines a subnet mask. <i>interface</i> : Defines an interface name. <i>add/remove</i> : Adds or deletes a specific VLAN. |

| | |
|---------------------|--|
| | <i>vlan-list</i> : Indicates a VLAN index. |
| Command Mode | Address management mode |
| Usage Guide | After configuration, DHCP clients are assigned IP addresses from the default address range based on the VLAN and port. |

↘ Assigning Static IP Address Based on VLAN

| | |
|------------------------------|--|
| Command | match ip <i>ip-address netmask</i> [add/remove] vlan <i>vlan-list</i> |
| Parameter Description | <i>ip-address</i> : Defines an IP address. <i>netmask</i> : Defines a subnet mask. <i>add/remove</i> : Adds or deletes a specific VLAN. <i>vlan-list</i> : Indicates a VLAN index. |
| Command Mode | Address management mode |
| Usage Guide | In a Super VLAN, a client may be assigned a fixed static address no matter which Super VLAN the client resides in. You do not need to configure an AM rule for this IP address based on all sub-VLANs and ports, but only configure an AM rule based on the VLAN. This rule takes effect for only static address assignment. |

Configuration Example

↘ Configuring AM Rule

| | |
|----------------------------|--|
| Configuration Steps | <ul style="list-style-type: none"> ● Configure a default rule. ● Configure a rule based on a specific VLAN, port and address range. ● Configure a rule based on a specific VLAN and address range. |
| | <pre>Ruijie(config)# address-manage Ruijie(config-address-manage)# match ip default 172.50.128.0 255.255.128.0 Ruijie(config-address-manage)# match ip 10.1.5.0 255.255.255.0 Gi5/3 vlan 1005 Ruijie(config-address-manage)# match ip 10.1.6.0 255.255.255.0 vlan 1006</pre> |
| Verification | 1: Run the show run command to display the configuration. |
| | <pre>address-manage match ip default 172.50.128.0 255.255.128.0 match ip 10.1.5.0 255.255.255.0 Gi5/3 vlan 1005 match ip 10.1.6.0 255.255.255.0 vlan 1006</pre> |

4.4.4 Configuring Global Properties of DHCP Server

Configuration Effect

Enable a server with specific functions, for example, ping and compulsory NAK.

Notes

Configuring the command may cause exceptions on other servers.

Configuration Steps

↘ Configuring Excluded IP Address

- Optional. Configure some addresses or address ranges as unavailable.
- Run the **ip dhcp excluded-address** command in global configuration mode.

↘ Configuring Compulsory NAK Reply

- Optional. A server replies to a wrong address request with a NAK packet.
- Run the **ip dhcp force-send-nak** command in global configuration mode.

↘ Configuring VRRP Status Monitoring

- Optional. After configuration, DHCP packets are processed by the Master server.
- Run the **ip dhcp monitor-vrrp-state** command in global configuration mode.

↘ Configuring Ping Times

- Optional. Check the address reachability with the **ping** command. The default is 2.
- Run the **ip dhcp ping packet** command in global configuration mode.

↘ Configuring Ping Timeout

- Optional. Check the address reachability with the **ping** command. The default is 500 ms.
- Run the **ip dhcp ping timeout** command in global configuration mode.

↘ Refreshing Trusted ARP

- Configure a DHCP server to refresh trusted ARPs according to the addresses assigned from an address pool configured with the **update arp** command.
- Run the **ip dhcp refresh arp** command in global configuration mode.

↘ Detecting User Offline Detection

- Configure a DHCP server to detect whether the client is offline or not. If a client does not get online after being offline for a period, the address assigned to the client will be retrieved.
- Run the **ip dhcp server arp-detect** command in global configuration mode.

↘ Configuring Pseudo Server Detection

- Optional. Enable this function to log a pseudo server.
- Run the **ip dhcp server detect** command in global configuration mode.

Verification

Run the **dhcp-server** command, and check the configuration during address assignment.

Related Commands

↘ Configuring Excluded IP Address

| | |
|---------------------|---|
| Command | ip dhcp excluded-address <i>low-ip-address</i> [<i>high-ip-address</i>] |
| Parameter | <i>low-ip-address</i> : Indicates a start IP address. |
| Description | <i>high-ip-address</i> : Indicates an end IP address. |
| Command Mode | Global configuration mode |
| Usage Guide | Unless otherwise specified, a DHCP server assigns all the addresses from an IP address pool to DHCP clients. To reserve some addresses(e.g., addresses already assigned to the server or devices), you need to configure these addresses as excluded addresses. To configure a DHCP server, it is recommended to configure excluded addresses to avoid address conflict and shorten detection time during address assignment. |

↘ Configuring Compulsory NAK Reply

| | |
|---------------------|--|
| Command | ip dhcp force-send-nak |
| Parameter | N/A |
| Description | |
| Command Mode | Global configuration mode |
| Usage Guide | In a WLAN, a DHCP client often moves from one network to another. When a DHCP server receives a lease renewal request from a client but finds that the client crosses the network segment or that the lease is expired, it replies with a NAK packet to require the client to obtain an IP address again. This prevents the client from sending request packets continually before obtaining an IP address again after timeout. The server sends a NAK packet only when it finds the client's lease record. When a DHCP client crosses the network, a DHCP server cannot find lease record of the client and will not reply with a NAK packet. The client sends request packets continually before obtaining an IP address again after timeout. Consequently, it takes a long to obtain an IP address. This also occurs when a DHCP server loses a lease after restart and a client requests lease renewal. In this case, you may configure a command to force the DHCP server to reply with a NAK packet even though it cannot find the lease record so that the client may obtain an IP address rapidly. Please note that the command is disabled by default. To enable it, only one DHCP server can be configured in a broadcast domain. |

↘ Configuring Ping Times

| | |
|------------------------------|--|
| Command | ip dhcp ping packets [<i>number</i>] |
| Parameter Description | <i>number</i> : (Optional) Ranges from 0 to 10. 0 indicates the ping function is disabled. The default is two pings. |
| Command Mode | Global configuration mode |
| Usage Guide | By default, when a DHCP server assigns an IP address from a pool, it runs the Ping command twice (one packet per time). If there is no reply, the server takes the address as idle and assigns it to a client. If there is a reply, the server takes the address as occupied and assigns another address. |

↘ Configuring Ping Timeout

| | |
|------------------------------|--|
| Command | ip dhcp ping timeout <i>milliseconds</i> |
| Parameter Description | <i>milli-seconds</i> : Indicates the time that it takes for a DHCP server to wait for a ping reply. The value ranges from 100 ms to 10,000 ms. |
| Command Mode | Global configuration mode |
| Usage Guide | By default, if a DHCP server receives no Ping reply within 500 ms, the IP address is available. You may adjust the ping timeout to change the time for a server to wait for a reply. |

↘ Refreshing Trusted ARP

| | |
|------------------------------|--|
| Command | ip dhcp refresh arp |
| Parameter Description | N/A |
| Command Mode | Global configuration mode |
| Usage Guide | By default, if an address pool is configured with the update arp command, a DHCP server will refresh trusted ARPs while assigning an IP address from the address pool. If a client clears the trusted ARPs, the server will not reassign them. After configuration, a DHCP server may refresh trusted ARPs according to addresses assigned from an address pool configured with update arp . |

↘ Configuring ARP-Based Offline Detection

| | |
|------------------------------|---|
| Command | ip dhcp server arp-detect |
| Parameter Description | N/A |
| Command Mode | Global configuration mode |
| Usage Guide | By default, DHCP server does not detect whether a client is offline or not based on ARP. After configuration, a DHCP server may perform the detection. If a client does not get online again after a period (5 minutes by default), a DHCP server retrieves the address assigned to the client. |

↘ Configuring Pseudo Server Detection

| | |
|---------------------|---|
| Command | ip dhcp server detect |
| Parameter | N/A |
| Description | |
| Command Mode | Global configuration mode |
| Usage Guide | By default, pseudo server detection is disabled on a DHCP server. Run this command to enable pseudo server detection. |

Configuration Example

Configuring Ping

| | |
|----------------------------|--|
| Configuration Steps | <ul style="list-style-type: none"> Set ping times to 5. Set ping timeout to 800ms. |
| | <pre>Ruijie(config)# ip dhcp ping packet 5 Ruijie(config)# ip dhcp ping timeout 800</pre> |
| Verification | Run the show run command to display the configuration. |
| | <pre>Ruijie(config)#show run begin ip dhcp ip dhcp ping packet 5 ip dhcp ping timeout 800</pre> |

Configuring Excluded IP Address

| | |
|----------------------------|--|
| Configuration Steps | <ul style="list-style-type: none"> Configure the excluded IP address from 192.168.0.0 to 192.168.255.255. |
| | <pre>Ruijie(config)# ip dhcp excluded-address 192.168.0.0 192.168.255.255</pre> |
| Verification | Run the show run command to display the configuration. |
| | <pre>Ruijie(config)#show run begin ip dhcp ip dhcp excluded-address 192.168.0.0 192.168.255.255</pre> |

4.4.5 Configuring Basic DHCP Relay Functions

Configuration Effect

- Deploy dynamic IP management in Client–Relay–Server mode to achieve communication between a DHCP client and a DHCP server, which are in different network segments.

Notes

- To enable DHCP Relay, you need to configure IPv4 unicast routing in a network.

Configuration Steps

▾ Enabling DHCP Relay

- Mandatory.
- Unless otherwise specified, you need to enable DHCP Relay on a device.

▾ Configuring IP Address for DHCP Server

- Mandatory.
- You need to configure an IP address for a DHCP server.

Verification

- Check whether a client obtains an IP address through DHCP Relay.

Related Commands

▾ Enabling DHCP Relay

| | |
|------------------------------|---------------------------|
| Command | service dhcp |
| Parameter Description | N/A |
| Command Mode | Global configuration mode |
| Usage Guide | N/A |

▾ Configuring IP Address for DHCP Server

| | |
|------------------------------|--|
| Command | ip helper-address { cycle-mode A.B.C.D } |
| Parameter Description | <i>cycle-mode</i> : Indicates that DHCP request packets are forwarded to all DHCP servers. <i>A.B.C.D</i> : Indicates the IP address of a server. |
| Command Mode | Global configuration mode |
| Usage Guide | |

Configuration Example

▾ Configuring DHCP Relay in Wired Connection



| | |
|----------------------------|---|
| Configuration Steps | <ul style="list-style-type: none"> ● Enable a client with DHCP to obtain an IP address. ● Enable the DHCP Relay function on a DHCP relay agent. ● Configure DHCP Server. |
| A | Enable a client with DHCP to obtain an IP address. |
| B | <p>Enable DHCP Relay.</p> <pre>Ruijie(config)# service dhcp</pre> <p>Configure a global IP address of a DHCP server.</p> <pre>Ruijie(config)# ip helper-address 172.2.2.1</pre> <p>Configure an IP address for the port connected to the client.</p> <pre>Ruijie(config)# interface gigabitEthernet 0/1</pre> <pre>Ruijie(config-if)# ip address 192.1.1.1 255.255.255.0</pre> <p>Configure an IP address for the port connected to the server.</p> <pre>Ruijie(config)# interface gigabitEthernet 0/2</pre> <pre>Ruijie(config-if-gigabitEthernet 0/2)# ip address 172.2.2.2 255.255.255.0</pre> |
| C | <p>Enable DHCP Server.</p> <pre>Ruijie(config)# service dhcp</pre> <p>Configure an address pool.</p> <pre>Ruijie(config)# ip dhcp pool relay</pre> <pre>Ruijie (dhcp-config)#network 192.1.1.0 255.255.255.0</pre> <pre>Ruijie (dhcp-config)#default-router 192.1.1.1</pre> <p>Configure an IP address for the port connected to the relay agent.</p> <pre>Ruijie(config)# interface gigabitEthernet 0/1</pre> <pre>Ruijie(config-if-gigabitEthernet 0/2)# ip address 172.2.2.1 255.255.255.0</pre> |
| | |
| Verification | <p>Check whether the client obtains an IP address.</p> <ul style="list-style-type: none"> ● Check whether the client obtains an IP address. ● Check the DHCP Relay configuration. |
| A | The user device obtains an IP address. |
| B | <p>After login to the DHCP relay agent, run the show running-config command in privileged EXEC mode to display DHCP Relay configuration.</p> <pre>Ruijie# show running-config</pre> <pre>service dhcp</pre> <pre>ip helper-address 172.2.2.1</pre> <pre>!</pre> |

```
interface GigabitEthernet 0/1
ip address 192.1.1.1 255.255.255.0
!
interface GigabitEthernet 0/2
ip address 172.2.2.2 255.255.255.0
!
```

Common Errors

- IPv4 unicast routing configuration is incorrect.
- DHCP Relay is disabled.
- No routing between DHCP relay agent and DHCP server is configured.
- No IP address is configured for the DHCP server.

4.4.6 Configuring DHCP Relay Option 82

Configuration Effect

- Through a DHCP relay agent, a server may assign IP addresses of different privileges to the clients more accurately based on the option information.

Notes

- You need to enable the DHCP Relay function.

Configuration Steps

📌 Enabling Basic DHCP Relay Functions

- Mandatory.
- Unless otherwise specified, you need to enable DHCP Relay on a device.

📌 Enables DHCP Option82

- By default, DHCP Option 82 is disabled.
- You may run the **ip dhcp relay information option82** command to enable or disable DHCP Option 82.

Verification

- Check whether the client obtains an IP address based on Option 82.

Related Commands

📌 Enabling DHCP Option 82

| | |
|---------------------|---|
| Command | ip dhcp relay information option82 |
| Parameter | N/A |
| Description | |
| Command Mode | Global configuration mode |
| Usage Guide | N/A |

Configuration Example

↳ Enabling DHCP Option 82

| | |
|----------------------------|--|
| Configuration Steps | <ul style="list-style-type: none"> Enable DHCP Option 82. |
| | <pre>Ruijie(config)# ip dhcp relay information option82</pre> |
| Verification | After login to the DHCP relay agent, run the show running-config command in privileged EXEC mode to display DHCP Relay configuration. |
| | <pre>Ruijie#show ru incl ip dhcp relay ip dhcp relay information option82</pre> |

Common Errors

- Basic DHCP Relay functions are not configured.

4.4.7 Configuring DHCP Relay Check Server-ID

Configuration Effect

- After you configure the **ip dhcp relay check server-id**, a DHCP Relay agent will forward DHCP request packets only to the server specified by the **option server-id** command. Otherwise, they are forwarded to all DHCP servers.

Notes

- You need to enable basic DHCP Relay functions.

Configuration Steps

↳ Enabling DHCP Relay Check Server-ID

- By default, DHCP Relay check server-id is disabled.
- You may run the **ip dhcp relay check server-id** command to enable DHCP Relay check server-id.

Verification

Check whether a DHCP Relay agent sends DHCP request packets only to the server specified by the **option server-id** command.

Related Commands

Configuring DHCP Relay Check Server-ID

| | |
|------------------------------|--------------------------------------|
| Command | ip dhcp relay check server-id |
| Parameter Description | N/A |
| Command Mode | Global configuration mode |
| Usage Guide | N/A |

Configuration Example

Configuring DHCP Relay Check Server-ID

| | |
|----------------------------|---|
| Configuration Steps | <ul style="list-style-type: none"> ● Enable DHCP Relay.Omitted. ● Enable DHCP Relay check server-id on an interface. |
| | <pre>Ruijie# configure terminal Ruijie(config)# ip dhcp relay check server-id</pre> |
| Verification | After login to the DHCP relay agent, run the show running-config command in privileged EXEC mode to display DHCP Relay configuration. |
| | <pre>Ruijie# show running-config include check server-id ip dhcp relay check server-id Ruijie#</pre> |

Common Errors

- Basic DHCP Relay functions are not configured.

4.4.8 Configuring DHCP Relay Suppression

Configuration Effect

- After you configure the **ip DHCP Relay suppression** command on an interface, DHCP request packets received on the interface will be filtered, and the other DHCP requests will be forwarded.

Notes

- You need to enable basic DHCP Relay functions.

Configuration Steps

Enabling DHCP Relay Suppression

By default, DHCP Relay suppression is disabled on all interfaces.

You may run the **ip dhcp relay suppression** command to enable DHCP Relay suppression.

Verification

- Check whether the DHCP request packets received on the interface are filtered.

Related Commands

▾ Configuring DHCP Relay Suppression

| | |
|---------------------|----------------------------------|
| Command | ip dhcp relay suppression |
| Parameter | N/A |
| Description | |
| Command Mode | Interface configuration mode |
| Usage Guide | N/A |

Configuration Example

▾ Configuring DHCP Relay Suppression

| | |
|----------------------------|--|
| Configuration Steps | <ul style="list-style-type: none"> ● Configure basic DHCP Relay functions. ● Configure DHCP Relay suppression on an interface. |
| | <pre>Ruijie# configure terminal Ruijie(config)# interface gigabitEthernet 0/1 Ruijie(config-if-GigabitEthernet 0/1)# ip dhcp relay suppression Ruijie(config-if-GigabitEthernet 0/1)#end Ruijie#</pre> |
| Verification | After login to the DHCP relay agent, run the show running-config command in privileged EXEC mode to display DHCP Relay configuration. |
| | <pre>Ruijie# show running-config include relay suppression ip dhcp relay suppression Ruijie#</pre> |

Common Errors

Basic DHCP Relay functions are not configured.

4.4.9 Configuring DHCP Client

Configuration Effect

Enable DHCP Client on a device so that it obtains IP addresses and configurations dynamically.

Notes

Ruijie products support DHCP Client configuration on Ethernet, FR, PPP and HDLC interfaces.

Configuration Steps

Run the **ip address dhcp** command on an interface.

Verification

Check whether the interface obtains an IP address.

Related Commands

▾ Configuring DHCP Client

| | |
|---------------------|---|
| Command | ip address dhcp |
| Parameter | N/A |
| Description | |
| Command Mode | Interface configuration mode |
| Usage Guide | <ul style="list-style-type: none"> ● Ruijie products support dynamic IP address obtainment by an Ethernet interface. ● Ruijie products support dynamic IP address obtainment by a PPP-encapsulated interface. ● Ruijie products support dynamic IP address obtainment by an FR-encapsulated interface. ● Ruijie products support dynamic IP address obtainment by an HDLC-encapsulated interface. |

Configuration Example

▾ Configuring DHCP Client

| | |
|----------------------------|---|
| Configuration Steps | 1: Enable port FastEthernet 0/0 with DHCP to obtain an IP address. |
| | <pre>Ruijie(config)# interface FastEthernet0/0 Ruijie(config-if-FastEthernet 0/0)#ip address dhcp</pre> |
| Verification | 1: Run the show run command to display the configuration. |
| | <pre>Ruijie(config)#show run begin ip address dhcp ip address dhcp</pre> |

4.5 Monitoring

Clearing

 Running the clear commands may lose vital information and interrupt services.

| Description | Command |
|---|---|
| Clears DHCP address binding. | clear ip dhcp binding { address * } |
| Clears DHCP address conflict. | clear ip dhcp conflict { address * } |
| Clears statistics of a DHCP server. | clear ip dhcp server statistics |
| Clears statistics of a DHCP relay. | clear ip dhcp relay statistics |
| Clears statistics of DHCP server performance. | clear ip dhcp server rate |
| Clears information of a DHCP pseudo server. | clear ip dhcp server detect |

Displaying

| Description | Command |
|--|--------------------------------------|
| Displays DHCP lease. | show dhcp lease |
| Displays manually configured IP addresses. | show dhcp manual |
| Displays DHCP sockets. | show ip dhcp socket |
| Displays assigned IP addresses. | show ip dhcp binding |
| Displays created address pools. | show ip dhcp pool |
| Displays statistics of DHCP Server. | show ip dhcp server statistic |
| Displays statistics of DHCP Relay. | show ip dhcp relay statistic |
| Displays conflicted addresses. | show ip dhcp conflict |
| Displays the DHCP pseudo server. | show ip dhcp server detect |

Debugging

 System resources are occupied when debugging information is output. Therefore, disable debugging immediately after use.

| Description | Command |
|----------------------------|-----------------------------------|
| Debugs DHCP agent. | debug ip dhcp server agent |
| Debugs DHCP hot backup. | debug ip dhcp server ha |
| Debugs DHCP address pools. | debug ip dhcp server pool |
| Debugs DHCP VRRP. | debug ip dhcp server vrrp |
| Debugs all DHCP servers. | debug ip dhcp server all |
| Debugs DHCP packets. | debug ip dhcp client |
| Debugs DHCP Relay events. | debug ip dhcp relay |

5 Configuring DNS

5.1 Overview

A Domain Name System (DNS) is a distributed database containing mappings between domain names and IP addresses on the Internet, which facilitate users to access the Internet without remembering IP strings that can be directly accessed by computers. The process of obtaining an IP address through the corresponding host name is called domain name resolution (or host name resolution).

Protocols and Standards

- RFC1034: DOMAIN NAMES - CONCEPTS AND FACILITIES
- RFC1035: DOMAIN NAMES - IMPLEMENTATION AND SPECIFICATION

5.2 Applications

| Application | Description |
|--|--|
| Static Domain Name Resolution | Performs domain name resolution directly based on the mapping between a domain name and an IP address on a device. |
| Dynamic Domain Name Resolution | Obtains the IP address mapped to a domain name dynamically from a DNS server on the network. |

5.2.1 Static Domain Name Resolution

Scenario

- Preset the mapping between a domain name and an IP address on a device.
- When you perform domain name operations (such as Ping and Telnet) through application programs, the system can resolve the IP address without being connected to a server on the network.

Deployment

- Preset the mapping between a domain name and an IP address on a device.

5.2.2 Dynamic Domain Name Resolution

Scenario

- DNS Server is deployed on the network to provide the domain name service.
- Domain name "host.com" is deployed on the network.
- Device-A applies to DNS Server for domain name "host.com".

Figure 5-1 Dynamic Domain Name Resolution

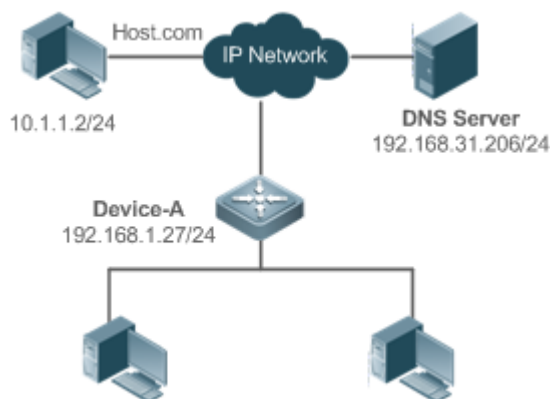

Deployment

- Deploy DNS Server as the DNS server of Device-A.

5.3 Features

Basic Concepts

↘ DNS

The DNS consists of a resolver and a DNS server. The DNS server stores the mappings between domain names and IP addresses of all hosts on the network, and implements mutual conversion between the domain names and IP addresses. Both the TCP and UDP port IDs of DNS are 53, and generally a UDP port is used.

Features

| Feature | Description |
|--|--|
| Domain Name Resolution | IP addresses are obtained based on domain names from a DNS server or a local database. |

5.3.1 Domain Name Resolution

Working Principle

↘ Static Domain Name Resolution

Static domain name resolution means that a user presets the mapping between a domain name and an IP address on a device. When you perform domain name operations (such as Ping and Telnet) through application programs, the system can resolve the IP address without being connected to a server on the network.

↘ Dynamic Domain Name Resolution

Dynamic domain name resolution means that when a user perform domain name operations through application programs, the DNS resolver of the system queries an external DNS server for the IP address mapped to the domain name.

The procedure of dynamic domain name resolution is as follows:

1. A user application program (such as Ping or Telnet) requests the IP address mapped to a domain name from the DNS resolver of the system.
2. The DNS resolver queries the dynamic cache at first. If the domain name on the dynamic cache does not expire, the DNS resolver returns the domain name to the application program.
3. If all domain names expire, the DNS resolver initiates a request for domain name-IP address conversion to the external DNS server.
4. After receiving a response from the DNS server, the DNS resolver caches and transfers the response to the application program.

Related Configuration

▾ Enabling Domain Name Resolution

- By default, domain name resolution is enabled.
- Run the **ip domain-lookup** command to enable domain name resolution.



▾ Configuring the IP Address Mapped to a Static Domain Name

- By default, no mapping between a domain name and an IP address is configured.
- Run the **ip host** command to specify the IPv4 address mapped to a domain name.
- Run the **ipv6 host** command to specify the IPv6 address mapped to a domain name.

▾ Configuring a DNS Server

- By default, no DNS server is configured.
- Run the **ip name-server** command to configure a DNS server.

5.4 Configuration

| Configuration | Description and Command | |
|--|---|--|
| Configuring Static Domain Name Resolution |  Optional. | |
| | ip domain-lookup | Enables domain name resolution. |
| | ip host | Configures the IPv4 address mapped to a domain name. |
| | ipv6 host | Configures the IPv6 address mapped to a domain name. |
| Configuring Dynamic Domain Name Resolution |  Optional. | |
| | ip domain-lookup | Enables domain name resolution. |
| | ip name-server | Configures a DNS server. |
| | | |

5.4.1 Configuring Static Domain Name Resolution

Configuration Effect

The system resolver resolves the IP address mapped to a domain name on a local device.

Configuration Steps

▾ Enabling Domain Name Resolution

- The domain name resolution function is enabled by default.
- If this function is disabled, static domain name resolution does not take effect.

▾ Configuring the IP Address Mapped to a Domain Name

- (Mandatory) Domain names to be used must be configured with mapped IP addresses.

Verification

- Run the **show run** command to check the configuration.
- Run the **show hosts** command to check the mapping between the domain name and the IP address.

Related Commands

▾ Configuring the IPv4 Address Mapped to a Domain Name

| | |
|---------------------|--|
| Command | ip host <i>host-name ip-address</i> |
| Parameter | <i>host-name</i> : indicates a domain name. |
| Description | <i>ip-address</i> : indicates a mapped IPv4 address. |
| Command Mode | Global configuration mode |
| Usage Guide | N/A |

▾ Configuring the IPv6 Address Mapped to a Domain Name

| | |
|---------------------|--|
| Command | ipv6 host <i>host-name ipv6-address</i> |
| Parameter | <i>host-name</i> : indicates a domain name. |
| Description | <i>ipv6-address</i> : indicates a mapped IPv6 address. |
| Command Mode | Global configuration mode |
| Usage Guide | N/A |

Configuration Example

▾ Configuring Static Domain Name Resolution

| | |
|----------------------------|--|
| Configuration Steps | <ul style="list-style-type: none"> ● Set the IP address of static domain name www.test.com to 192.168.1.1 on a device. ● Set the IP address of static domain name www.testv6.com to 2001::1 on a device. |
|----------------------------|--|

| | |
|---------------------|--|
| | <pre>Ruijie#configure terminal Ruijie(config)# ip host www.test.com 192.168.1.1 Ruijie(config)# ipv6 host www.testv6.com 2001::1 Ruijie(config)# exit</pre> |
| Verification | Run the show hosts command to check whether the static domain name entry is configured. |
| | <pre>Ruijie#show hosts Name servers are: Host type Address TTL(sec) www.test.com static 192.168.1.1 --- www.testv6.com static 2001::1 ---</pre> |

5.4.2 Configuring Dynamic Domain Name Resolution

Configuration Effect

The system resolver resolves the IP address mapped to a domain name through a DNS server.

Configuration Steps

▾ Enabling Domain Name Resolution

- Domain name resolution is enabled by default.
- If this function is disabled, dynamic domain name resolution does not take effect.

▾ Configuring a DNS Server

- (Mandatory) To use dynamic domain name resolution, you must configure an external DNS server.

Verification

- Run the **show run** command to check the configuration.

Related Commands

▾ Configuring a DNS Server

| | |
|---------------------|---|
| Command | ip name-server { <i>ip-address</i> <i>ipv6-address</i> } |
| Parameter | <i>ip-address</i> : indicates the IPv4 address of the DNS server. |
| Description | <i>ipv6-address</i> : indicates the IPv6 address of the DNS server. |
| Command Mode | Global configuration mode |
| Usage Guide | N/A |

Configuration Example

Configuring Dynamic Domain Name Resolution

| | |
|-------------------------------|--|
| Scenario Figure 5-2 |  <p>The diagram shows a network topology. On the left is a 'Device' represented by a blue square with a white cross. A line connects it to a central dark blue cloud representing a network. Another line connects the cloud to a 'DNS Server' represented by a blue server rack icon on the right. The IP address '192.168.10.1' is written below the DNS server icon.</p> |
| | Device resolves the domain name through the DNS server (192.168.10.1) on the network. |
| Configuration Steps | Set the IP address of the DNS server to 192.168.10.1 on the device. |
| | <pre> DEVICE#configure terminal DEVICE(config)# ip name-server 192.168.10.1 DEVICE(config)# exit </pre> |
| Verification | Run the show hosts command to check whether the DNS server is specified. |
| | <pre> Ruijie(config)#show hosts Name servers are: 192.168.10.1 static Host type Address TTL(sec) </pre> |

5.5 Monitoring

Clearing

 Running the **clear** command during device operation may cause data loss or even interrupt services.

| Description | Command |
|---|--|
| Clears the dynamic host name cache table. | clear host [<i>host-name</i>] |

Displaying

| Description | Command |
|--------------------------|--|
| Displays DNS parameters. | show hosts [<i>host-name</i>] |

Debugging

 System resources are occupied when debugging information is output. Therefore, disable debugging immediately after use.

| Description | Command |
|--------------------------|---------------------|
| Debugs the DNS function. | debug ip dns |

6 Configuring Network Communication Test Tools

6.1 Overview

Network communication test tools can be used to check the connectivity of a network and helps you analyze and locate network faults. Network communication test tools include Packet Internet Groper (PING) and Traceroute. Ping is used to check the connectivity and delay of a network. A greater delay indicates a slower network speed. Traceroute helps you learn about the topology of physical and logical links and transmission rate. On a network device, you can run the **ping** and **traceroute** commands to use the two tools respectively.

Protocols and Standards

- RFC792: Internet Control Message Protocol
- RFC4443: Internet Control Message Protocol (ICMPv6) for the Internet Protocol Version 6 (IPv6) Specification

6.2 Applications

| Application | Description |
|--|--|
| End-to-End Connectivity Test | Both the network device and the destination host are connected to the IP network and configured with IP addresses. |
| Host Route Test | Both the network device and the destination host are connected to the IP network and configured with IP addresses. |

6.2.1 End-to-End Connectivity Test

Scenario

As shown in Figure 6-1, Network Device A and Target Host B are connected to the IP network.

If both the network device and the target host are connected to the IP network, the end-to-end connectivity test aims to check whether IP packets can be transmitted between the two ends. The target host can be the network device itself. In this case, the connectivity test aims to check the network interface and TCP/IP configurations on the device.

Figure 6-1



Deployment

Execute the ping function on the network device.

6.2.2 Host Route Test

Scenario

As shown in Figure 6-2, Network Device A and Target Host B are connected to the IP network.

If both the network device and the target host are connected to the IP network, the host route test aims to check gateways (or routers) that IP packets pass through between the two ends. Generally, the target host is not within the same IP network segment as the network device.

Figure 6-2



Deployment

Execute the traceroute function on the network device.

6.3 Features

Overview

| Feature | Description |
|---------------------------------|--|
| Ping Test | Test whether the specified IPv4 or IPv6 address is reachable and display the related information. |
| Traceroute Test | Display the gateways that IPv4 or IPv6 packets pass through when transmitted from the source to the destination. |

6.3.1 Ping Test

Working Principle

The ping tool sends an Internet Control Message Protocol (ICMP) Request message to the destination host to request the for an ICMP Echo Reply message. In this way, the ping tool determines the delay and the connectivity between the two network devices.

Related Configuration

- Run the **ping** command.

6.3.2 Traceroute Test

Working Principle



The traceroute tool uses the Time To Live (TTL) field in the headers of the ICMP and IP messages for the test. First, the traceroute tool on the network device sends an ICMP Request message with TTL 1 to the destination host. After receiving

the message, the first router on the path decreases the TTL by 1. As the TTL becomes 0, the router drops the packets and returns an ICMP time exceeded message to the network device. After receiving this message, the traceroute tool learns that this router exists on this path, and then sends an ICMP Request packet with TTL 2 to the destination host to discover the second router. Each time the traceroute tool increases the TTL in the ICMP Request message by 1 to discover one more router. This process is repeated until a data packet reaches the destination host. After the packet reaches the destination host, the host returns an ICMP Echo message instead of an ICMP time exceeded message to the network device. Then, the traceroute tool finishes the test and displays the path from the network device to the destination host.

Related Configuration

- Run the **traceroute** command.

6.4 Configuration

| Configuration | Description and Command |
|---------------------------------|---|
| Ping Test |  (Optional) It is used to check whether an IPv4 or IPv6 address is reachable. |
| | ping Executes the Ping function. |
| Traceroute Test |  (Optional) It is used to display the gateways that IPv4 or IPv6 packets pass through when transmitted from the source to the destination. |
| | traceroute Executes the traceroute function. |

6.4.1 Ping Test

Configuration Effect

After conducting a ping test on a network device, you can learn whether the network device is connected to the destination host and whether packets can be transmitted between the network device and the destination host.

Notes

The network device must be configured with an IP address.

Configuration Steps

- To check whether an IPv4 address is reachable, use the **ping IPv4** command.
- To check whether an IPv6 address is reachable, use the **ping IPv6** command.

Verification

Run the **ping** command to display related information on the command line interface (CLI) window.

Related Commands

📄 Ping IPv4

| | |
|------------------------------|---|
| Command | Ping [ip] [address [length length] [ntimes times] [timeout seconds] [data data] [source source] [df-bit] [validate] [detail]] |
| Parameter Description | <p><i>address</i>: Specifies the destination IPv4 address or domain name.</p> <p><i>length</i>: Specifies the length of the data packet. The value ranges from 36 to 18,024. The default length is 100.</p> <p><i>times</i>: Specifies the number of probes. The value ranges from 1 to 4,294,967,295.</p> <p><i>seconds</i>: Specifies the timeout. The value ranges from 1s to 10s.</p> <p><i>data</i>: Specifies the data in the packet. The data is a string of 1 to 255 bytes. By default, the string is "abcd".</p> <p><i>source</i>: Specifies the source IPv4 address or source port of the packet. The loopback interface address, for example, 127.0.0.1, cannot be used as the source address.</p> <p>df-bit: Configures the DF bit of the IP address. When the DF bit is set to 1, the packet is not fragmented. By default, the DF bit is 0.</p> <p>validate: Configures whether to verify the response packet.</p> <p>detail: Configures whether to display the Echo Reply message in detail. By default, only the exclamation mark (!) and dot (.) are displayed.</p> |
| Command Mode | <p>In User EXEC mode, you can execute only the basic ping function. In Privileged EXEC mode, you can execute the extended ping function.</p> <p>In other configuration modes, you can run the do command to execute the extended ping function. For details about the configuration, see the description about the do command.</p> |
| Configuration Usage | <p>When the ping function is executed, information about the response (if any) will be displayed, and then related statistics will be output. Using the extended ping function, you can specify the number, length and timeout of packets to be sent. Like the basic ping function, related statistics will be output.</p> <p>To use the domain name, you must first configure the domain name server (DNS). For details about the configuration, see <i>Configuring DNS</i>.</p> |

📌 Ping IPv6

| | |
|------------------------------|--|
| Command | Ping [ipv6] [address [length length] [ntimes times] [timeout seconds] [data data] [source source] [detail]] |
| Parameter Description | <p><i>address</i>: Specifies the destination IPv6 address or domain name.</p> <p><i>length</i>: Specifies the length of data packet. The value ranges from 16 to 18,024. The default length is 100.</p> <p><i>times</i>: Specifies the number of probes. The value ranges from 1 to 4,294,967,295.</p> <p><i>seconds</i>: Specifies the timeout. The value ranges from 1s to 10s.</p> <p><i>data</i>: Specifies the data in the packet. The data is a string of 1 to 255 bytes.</p> <p><i>source</i>: Specifies the source IPv6 address or source port of the packet. The loopback interface address, for example, ::1, cannot be used as the source address.</p> <p>Detail: Configures whether to display the Echo Reply message in detail. By default, only the exclamation mark (!) and dot (.) are displayed.</p> |
| Command Mode | <p>In User EXEC mode, you can execute only the basic ping IPv6 function. In Privileged EXEC mode, you can execute the extended ping IPv6 function.</p> <p>In other configuration modes, you can run the do command to execute the extended ping function. For details about the configuration, see the description about the do command.</p> |

| | |
|----------------------------|--|
| Configuration Usage | <p>When the ping IPv6 function is executed, information about the response (if any) will be displayed, and then related statistics will be output.</p> <p>Using the extended ping IPv6 function, you can specify the number, length and timeout of packets to be sent. Like the basic ping IPv6 function, related statistics will be output.</p> <p>To use the domain name, you must first configure the DNS. For details about the configuration, see <i>Configuring DNS</i>.</p> |
|----------------------------|--|

Configuration Example

↳ Executing the Common Ping Function

| | |
|----------------------------|--|
| Configuration Steps | <p>In Privileged EXEC mode, run the ping 192.168.21.26 command.</p> |
| | <pre> Common ping command: Ruijie# ping 192.168.21.26 Sending 5, 100-byte ICMP Echoes to 192.168.21.26, timeout is 2 seconds: < press Ctrl+C to break > !!!! Success rate is 100 percent (5/5), round-trip min/avg/max = 1/2/10 ms Detailed ping command: Ruijie#ping 192.168.21.26 detail Sending 5, 100-byte ICMP Echoes to 192.168.21.26, timeout is 2 seconds: < press Ctrl+C to break > Reply from 192.168.21.26: bytes=100 time=4ms TTL=64 Reply from 192.168.21.26: bytes=100 time=3ms TTL=64 Reply from 192.168.21.26: bytes=100 time=1ms TTL=64 Reply from 192.168.21.26: bytes=100 time=1ms TTL=64 Reply from 192.168.21.26: bytes=100 time=1ms TTL=64 Success rate is 100 percent (5/5), round-trip min/avg/max = 1/2/4 ms. </pre> |
| Verification | <p>Send five 100-byte packets to the specified IP address, and the response information will be displayed in the specified time (2s by default). Finally the statistics is output.</p> |

↳ Executing the Extended Ping Function

| | |
|----------------------------|---|
| Configuration Steps | <p>In Privileged EXEC mode, run the ping 192.168.21.26 command. In addition, specify the length, number, and timeout of the packets.</p> |
|----------------------------|---|

Common ping command:

```
Ruijie# ping 192.168.21.26 length 1500 ntimes 100 data ffff source 192.168.21.99 timeout 3
```

```
Sending 100, 1500-byte ICMP Echoes to 192.168.21.26, timeout is 3 seconds:
```

```
< press Ctrl+C to break >
```

```
!!!!!!!!!!!!!!!!!!!!!!!!!!!!!!!!!!!!!!!!!!!!!!!!!!!!!!!!!!!!!!!!!!!!!!!!!!!!!!!!!!!!!!!!!!!!!!!!!!!!!!!!!!!!!!!!!!!!!!!!!!!!!!  
!!!!!!
```

```
Success rate is 100 percent (100/100), round-trip min/avg/max = 2/2/3 ms
```

Detailed ping command:

```
ping 192.168.21.26 length 1500 ntimes 20 data ffff source 192.168.21.99 timeout 3 detail
```

```
Sending 20, 1500-byte ICMP Echoes to 192.168.21.26, timeout is 3 seconds:
```

```
< press Ctrl+C to break >
```

```
Reply from 192.168.21.26: bytes=1500 time=1ms TTL=64
```

```
Reply from 192.168.21.26: bytes=1500 time=1ms TTL=64
```

```
Reply from 192.168.21.26: bytes=1500 time=1ms TTL=64
```

```
Reply from 192.168.21.26: bytes=1500 time=1ms TTL=64
```

```
Reply from 192.168.21.26: bytes=1500 time=1ms TTL=64
```

```
Reply from 192.168.21.26: bytes=1500 time=1ms TTL=64
```

```
Reply from 192.168.21.26: bytes=1500 time=1ms TTL=64
```

```
Reply from 192.168.21.26: bytes=1500 time=2ms TTL=64
```

```
Reply from 192.168.21.26: bytes=1500 time=1ms TTL=64
```

```
Reply from 192.168.21.26: bytes=1500 time=1ms TTL=64
```

```
Reply from 192.168.21.26: bytes=1500 time=1ms TTL=64
```

```
Reply from 192.168.21.26: bytes=1500 time=1ms TTL=64
```

```
Reply from 192.168.21.26: bytes=1500 time=1ms TTL=64
```

```
Reply from 192.168.21.26: bytes=1500 time=1ms TTL=64
```

```
Reply from 192.168.21.26: bytes=1500 time=1ms TTL=64
```

```
Reply from 192.168.21.26: bytes=1500 time=1ms TTL=64
```

```
Reply from 192.168.21.26: bytes=1500 time=1ms TTL=64
```

```
Reply from 192.168.21.26: bytes=1500 time=3ms TTL=64
```

```
Reply from 192.168.21.26: bytes=1500 time=1ms TTL=64
```

```
Reply from 192.168.21.26: bytes=1500 time=1ms TTL=64
```

| | |
|---------------------|---|
| | Success rate is 100 percent (20/20), round-trip min/avg/max = 1/1/3 ms. |
| Verification | Send twenty 1500-byte packets to the specified IP address, and the response information (if any) will be displayed in the specified time (3s by default). Finally the statistics is output. |

↘ Executing the Common Ping IPv6 Function

| | |
|----------------------------|---|
| Configuration Steps | In Privileged EXEC mode, run the ping ipv6 2001::1 command. |
| | <pre> Common ping command: Ruijie# ping ipv6 2001::1 Sending 5, 100-byte ICMP Echoes to 2001::1, timeout is 2 seconds: < press Ctrl+C to break > !!!! Success rate is 100 percent (5/5), round-trip min/avg/max = 1/2/10 ms Detailed ping command: Ruijie#ping 2001::1 detail Sending 5, 100-byte ICMP Echoes to 2001::1, timeout is 2 seconds: < press Ctrl+C to break > Reply from 2001::1: bytes=100 time=1ms Reply from 2001::1: bytes=100 time=1ms Reply from 2001::1: bytes=100 time=1ms Reply from 2001::1: bytes=100 time=1ms Reply from 2001::1: bytes=100 time=1ms Success rate is 100 percent (5/5), round-trip min/avg/max = 1/1/1 ms. </pre> |
| Verification | Send five 100-byte packets to the specified IP address, and the response information will be displayed in the specified time (2s by default). Finally the statistics is output. |

↘ Executing the Extended Ping IPv6 Function

| | |
|----------------------------|---|
| Configuration Steps | In Privileged EXEC mode, run the ping ipv6 2001::5 command. In addition, specify the length, number, and timeout of the packets. |
| | Common ping command: |

| | |
|----------------------------|--|
| | <pre> Ruijie# ping ipv6 2001::5 length 1500 ntimes 100 data ffff source 2001::9 timeout 3 Sending 100, 1500-byte ICMP Echoes to 2000::1, timeout is 3 seconds: < press Ctrl+C to break > !! !!!!!! Success rate is 100 percent (100/100), round-trip min/avg/max = 2/2/3 ms Detailed ping command: Ruijie#ping 2001::5 length 1500 ntimes 10 data ffff source 2001::9 timeout 3 Sending 10, 1500-byte ICMP Echoes to 2001::5, timeout is 3 seconds: < press Ctrl+C to break > Reply from 2001::5: bytes=1500 time=1ms Reply from 2001::5: bytes=1500 time=1ms Reply from 2001::5: bytes=1500 time=1ms Reply from 2001::5: bytes=1500 time=1ms Reply from 2001::5: bytes=1500 time=1ms Reply from 2001::5: bytes=1500 time=1ms Reply from 2001::5: bytes=1500 time=1ms Reply from 2001::5: bytes=1500 time=1ms Reply from 2001::5: bytes=1500 time=1ms Reply from 2001::5: bytes=1500 time=1ms Reply from 2001::5: bytes=1500 time=1ms Success rate is 100 percent (10/10), round-trip min/avg/max = 1/1/1 ms. </pre> |
| <p>Verification</p> | <p>Send one hundred 1500-byte packets to the specified IPv6 address, and the response information (if any) will be displayed in the specified time (3s by default). Finally the statistics is output.</p> |

6.4.2 Traceroute Test

Configuration Effect

After conducting a traceroute test on a network device, you can learn about the routing topology between the network device and the destination host, and the gateways through which packets are sent from the network device to the destination host.

Notes

The network device must be configured with an IP address.

Configuration Steps

- To trace the route an IPv4 packet would follow to the destination host, run the **tracert** **IPv4** command.
- To trace the route an IPv6 packet would follow to the destination host, run the **tracert** **IPv6** command.

Verification

Run the **tracert** command to display related information on the CLI window.

Related Commands

Tracert IPv4

| | |
|------------------------------|---|
| Command | tracert [ip] [address [probe number] [source source] [timeout seconds] [ttl minimum maximum]] |
| Parameter Description | <p><i>address</i>: Specifies the destination IPv4 address or domain name.</p> <p><i>number</i>: Specifies the number of probes. The value ranges from 1 to 255.</p> <p><i>source</i>: Specifies the source IPv4 address or source port of the packet. The loopback interface address, for example, 127.0.0.1, cannot be used as the source address.</p> <p><i>seconds</i>: Specifies the timeout. The value ranges from 1s to 10s.</p> <p><i>minimum maximum</i>: Specifies the minimum and maximum TTL values. The value ranges from 1 to 255.</p> |
| Command Mode | In User EXEC mode, you can execute only the basic tracert function. In privileged EXEC mode, you can execute the extended tracert function. |
| Configuration Usage | The tracert command is used to test the network connectivity and accurately locate a fault when the fault occurs. To use the domain name, you must first configure the DNS. For details about the configuration, see <i>Configuring DNS</i> . |

Tracert IPv6

| | |
|------------------------------|---|
| Command | tracert [ipv6] [address [probe number] [timeout seconds] [ttl minimum maximum]] |
| Parameter Description | <p><i>address</i>: Specifies the destination IPv6 address or domain name.</p> <p><i>number</i>: Specifies the number of probes. The value ranges from 1 to 255.</p> <p><i>seconds</i>: Specifies the timeout. The value ranges from 1s to 10s.</p> <p><i>minimum maximum</i>: Specifies the minimum and maximum TTL values. The value ranges from 1 to 255.</p> |
| Command Mode | In User EXEC mode, you can execute only the basic tracert IPv6 function. In privileged EXEC mode, you can execute the extended tracert IPv6 function. |
| Configuration Usage | The tracert IPv6 command is used to test the network connectivity and accurately locate a fault when the fault occurs. To use the domain name, you must first configure the DNS. For details about the configuration, see <i>Configuring DNS</i> . |

Configuration Example

Executing the Tracert Function on a Properly Connected Network

| | |
|----------------------------|---|
| Configuration Steps | In Privileged EXEC mode, run the tracert 61.154.22.36 command. |
|----------------------------|---|

| | |
|--|--|
| | <pre> Ruijie# traceroute 61.154.22.36 < press Ctrl+C to break > Tracing the route to 61.154.22.36 1 192.168.12.1 0 msec 0 msec 0 msec 2 192.168.9.2 4 msec 4 msec 4 msec 3 192.168.9.1 8 msec 8 msec 4 msec 4 192.168.0.10 4 msec 28 msec 12 msec 5 202.101.143.130 4 msec 16 msec 8 msec 6 202.101.143.154 12 msec 8 msec 24 msec 7 61.154.22.36 12 msec 8 msec 22 msec </pre> |
| | <p>The preceding test result indicates that the network device accesses host 61.154.22.36 by transmitting packets through gateways 2-7. In addition, the time required to reach each gateway is displayed.</p> |

↘ Executing the Traceroute Function on a Faulty Network

| | |
|----------------------------|---|
| Configuration Steps | In Privileged EXEC mode, run the traceroute 202.108.37.42 command. |
|----------------------------|---|

| | |
|--|--|
| <pre> Ruijie# traceroute 202.108.37.42 < press Ctrl+C to break > Tracing the route to 202.108.37.42 1 192.168.12.1 0 msec 0 msec 0 msec 2 192.168.9.2 0 msec 4 msec 4 msec 3 192.168.110.1 16 msec 12 msec 16 msec 4 * * * 5 61.154.8.129 12 msec 28 msec 12 msec 6 61.154.8.17 8 msec 12 msec 16 msec 7 61.154.8.250 12 msec 12 msec 12 msec 8 218.85.157.222 12 msec 12 msec 12 msec 9 218.85.157.130 16 msec 16 msec 16 msec 10 218.85.157.77 16 msec 48 msec 16 msec 11 202.97.40.65 76 msec 24 msec 24 msec 12 202.97.37.65 32 msec 24 msec 24 msec 13 202.97.38.162 52 msec 52 msec 224 msec 14 202.96.12.38 84 msec 52 msec 52 msec 15 202.106.192.226 88 msec 52 msec 52 msec 16 202.106.192.174 52 msec 52 msec 88 msec 17 210.74.176.158 100 msec 52 msec 84 msec 18 202.108.37.42 48 msec 48 msec 52 msec </pre> | |
| | <p>The preceding test result indicates that the network device accesses host 202.108.37.42 by transmitting packets through gateways 1–17, and Gateway 4 is faulty.</p> |

↘ Executing the Traceroute IPv6 Function on a Properly Connected Network

| | |
|----------------------------|--|
| Configuration Steps | In Privileged EXEC mode, run the traceroute ipv6 3004::1 command. |
|----------------------------|--|

| | |
|--|---|
| | <pre> Ruijie# traceroute ipv6 3004::1 < press Ctrl+C to break > Tracing the route to 3004::1 1 3000::1 0 msec 0 msec 0 msec 2 3001::1 4 msec 4 msec 4 msec 3 3002::1 8 msec 8 msec 4 msec 4 3004::1 4 msec 28 msec 12 msec </pre> |
| | The preceding test result indicates that the network device accesses host 3004::1 by transmitting packets through gateways 1-4. In addition, the time required to reach each gateway is displayed. |

↘ Executing the Traceroute IPv6 Function on a Faulty Network

| | |
|----------------------------|---|
| Configuration Steps | In Privileged EXEC mode, run the traceroute ipv6 3004::1 command. |
| | <pre> Ruijie# traceroute ipv6 3004::1 < press Ctrl+C to break > Tracing the route to 3004::1 1 3000::1 0 msec 0 msec 0 msec 2 3001::1 4 msec 4 msec 4 msec 3 3002::1 8 msec 8 msec 4 msec 4 * * * 5 3004::1 4 msec 28 msec 12 msec </pre> |
| | The preceding test result indicates that the network device accesses host 3004::1 by transmitting packets through gateways 1–5, and Gateway 4 is faulty. |

7 Configuring TCP

7.1 Overview

The Transmission Control Protocol (TCP) is a transport-layer protocol providing reliable connection-oriented and IP-based services to for the application layer.

Internetwork data flows in 8-bit bytes are sent from the application layer to the TCP layer, and then fragmented into packet segments of a proper length via the TCP. The Maximum Segment Size (MSS) is usually limited by the Maximum Transmission Unit (MTU) of the data link layer. After that, the packets are sent to the IP layer and then to the TCP layer of a receiver through the network.

To prevent packet loss, every byte is identified by a sequence number via the TCP, and this ensures that packets destined for the peer are received in order. Then, the receiver responds with a TCP ACK packet upon receiving a packet. If the sender does not receive ACK packets in a reasonable Round-Trip Time (RTT), the corresponding packets (assumed lost) will be retransmitted.

- TCP uses the checksum function to check data integrity. Besides, MD5-based authentication can be used to verify data.
- Timeout retransmission and piggyback mechanism are adopted to ensure reliability.
- The Sliding Window Protocol is adopted to control flows. As documented in the Protocol, unidentified groups in a window should be retransmitted.

Protocols and Standards

- RFC 793: Transmission Control Protocol
- RFC 1122: Requirements for Internet Hosts -- Communication Layers
- RFC 1191: Path MTU Discovery
- RFC 1213: Management Information Base for Network Management of TCP/IP-based Internets: MIB-II
- RFC 2385: Protection of BGP Sessions via the TCP MD5 Signature Option
- RFC 4022: Management Information Base for the Transmission Control Protocol (TCP)

7.2 Applications

| Application | Description |
|--|--|
| Optimizing TCP Performance | To avoid TCP packet fragmentation on a link with a small MTU, Path MTU Discovery (PMTUD) is enabled. |
| Detecting TCP Connection Exception | TCP checks whether the peer works normally. |

7.2.1 Optimizing TCP Performance

Scenario

For example, TCP connection is established between A and D, as shown in the following figure. The MTU of the link between A and B is 1500 bytes, 1300 bytes between B and C, and 1500 bytes between C and D. To optimize TCP transmission performance, packet fragmentation should be avoided between B and C.

Figure 7-1

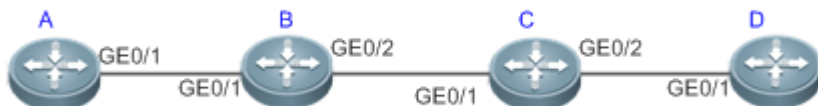

Remarks: A, B, C and D are routers.

Deployment

- Enable PMTUD on A and D.

7.2.2 Detecting TCP Connection Exception

Scenario

For example, in the following figure, User logs in to A through telnet but is shut down abnormally, as shown in the following figure. In case of TCP retransmission timeout, the User's TCP connection remains for a long period. Therefore, TCP keepalive can be used to rapidly detect TCP connection exception.

Figure 7-2

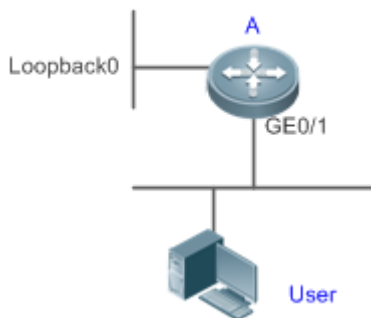

Remarks: A is a router.

Deployment

- Enable TCP keepalive on A.

7.3 Features

Basic Concepts

↳ TCP Header Format



- **Source Port** is a 16-bit source port number.
- **Destination Port** is a 16-bit destination port number.
- **Sequence Number** is a 32-bit sequence number.
- **Acknowledgment Number** is a 32-bit number that identifies the next sequence number that the receiver is expecting to receive.
- **Data Offset** is a 4-bit number that indicates the total number of bytes in the TCP header (option included) divided by 4.
- A flag bit is 6-bit. URG: the urgent pointer field is significant; ACK: the acknowledgment field is significant; PSH: indicates the push function; RST: resets TCP connection; SYN: synchronizes the sequence number (establishing a TCP connection); FIN: no more data from the sender (closing a TCP connection).

- A 16-bit Window value is used to control flows. It specifies the amount of data that may be transmitted from the peer between ACK packets.
- **Checksum** is a 16-bit checksum.
- **Urgent Pointer** is 16-bit and shows the end of the urgent data so that interrupted data flows can continue. When the URG bit is set, the data is given priority over other data flows.

↘ TCP Three-Way Handshake

- The process of TCP three-way handshake is as follows:
 1. A client sends a SYN packet to the server.
 2. The server receives the SYN packet and responds with a SYN ACK packet.
 3. The client receives the SYN packet from the server and responds with an ACK packet.
- After the three-way handshake, the client and server are connected successfully and ready for data transmission.

Overview

| Feature | Description |
|--|--|
| Configuring SYN Timeout | Configure a timeout waiting for a response packet after an SYN or SYN ACK packet is sent. |
| Configuring Window Size | Configure a window size. |
| Configuring Reset Packet Sending | Configure the sending of TCP reset packets after receiving port unreachable messages. |
| Configuring MSS | Configure an MSS for TCP connection. |
| Configuring MSS Value for SYN Packet | Modify the MSS value in a SYN packet. |
| Path MTU Discovery | Discover the smallest MTU on TCP transmission path, and adjust the size of TCP packets based on this MTU to avoid fragmentation. |
| TCP Keepalive | Check whether the peer works normally. |

7.3.1 Configuring SYN Timeout

Working Principle

A TCP connection is established after three-way handshake: The sender sends an SYN packet, the receiver replies with a SYN ACK packet, and then the sender replies with an ACK packet.

- If the receiver does not reply with a SYN ACK packet after the sender sends an SYN packet, the sender keeps retransmitting the SYN packet for certain times or until timeout period expires.
- If the receiver replies with a SYN ACK packet after the sender sends an SYN packet but the sender does not reply with an ACK packet, the receiver keeps retransmitting the SYN ACK packet for certain times or until timeout period expires. (This occurs in the case of SYN flooding.)

Related Configuration

↘ Configuring TCP SYN Timeout

- The default TCP SYN timeout is 20 seconds.
- Run the **ip tcp synwait-time** *seconds* command in global configuration mode to configure an SYN timeout ranging from 5 to 300 seconds.
- In case of SYN flooding, shortening SYN timeout reduces resource consumption. However, it does not work in continuous SYN flooding. When a device actively makes a request for a connection with an external device, through telnet for example, shortening SYN timeout reduces user's wait time. You may prolong SYN timeout properly on a poor network.

i The **ip tcp syntime-out** command in version 10.x is disused but compatible in version 11.0. If this command is executed, it will be converted to the **ip tcp synwait-time** command.

i In version 10.x, the configuration applies to only IPv4 TCP. In version 11.0 or later, it applies to both IPv4 TCP and IPv6 TCP.

7.3.2 Configuring Window Size

Working Principle

Data from the peer is cached in the TCP receiving buffer and subsequently read by applications. The TCP window size indicates the size of free space of the receiving buffer. For wide-bandwidth bulk-data connection, enlarging the window size dramatically promotes TCP transmission performance.

Related Configuration

↘ Configuring Window Size

- Run the **ip tcp window-size** *size* command in global configuration mode to configure a window size ranging from 128 to (65535<< 14) bytes. The default is 65535 bytes. If the window size is greater than 65535 bytes, window enlarging will be enabled automatically.
- The window size advertised to the peer is the smaller value between the configured window size and the free space of the receiving buffer.

i In version 10.x, the configuration applies to only IPv4 TCP. In version 11.0 or later, it applies to both IPv4 TCP and IPv6 TCP.

7.3.3 Configuring Reset Packet Sending

Working Principle

When TCP packets are distributed to applications, if the TCP connection a packet belongs to cannot be identified, the local end sends a reset packet to the peer to terminate the TCP connection. Attackers may use port unreachable messages to attack the device.

Related Configuration

Configuring the Sending of TCP Reset Packets After Receiving Port Unreachable Messages

By default, TCP reset packet sending upon receiving port unreachable messages is enabled.

Run the **no ip tcp send-reset** command in global configuration mode to disable TCP reset packet sending upon receiving port unreachable messages.

After this function is enabled, attackers may use port unreachable messages to attack the device.

- i** The **ip tcp not-send-rst** command in version 10.x is disused but compatible in version 11.0. If this command is executed, it will be converted to the **no ip tcp send-reset** command.
- i** In version 10.x, the configuration applies to only IPv4 TCP. In version 11.0 or later, it applies to both IPv4 TCP and IPv6 TCP.

7.3.4 Configuring MSS

Working Principle

The MSS refers to the total amount of data contained in a TCP segment excluding TCP options.

Three-way handshake is implemented through MSS negotiation. Both parties add the MSS option to SYN packets, indicating the largest amount of data that the local end can handle, namely, the amount of data allowed from the peer. Both parties take the smaller MSS between them as the advertised MSS.

The MSS value is calculated as follows:

- IPv4 TCP: $MSS = \text{Outgoing interface MTU} - \text{IP header size (20-byte)} - \text{TCP header size (20-byte)}$.
- IPv6 TCP: $MSS = \text{IPv6 Path MTU} - \text{IPv6 header size (40-byte)} - \text{TCP header size (20-byte)}$.
- i** In version 10.x, the configuration applies to only IPv4 TCP. In version 11.0 or later, it applies to both IPv4 TCP and IPv6 TCP.
- i** The effective MSS is the smaller one between the calculated MSS and the configured MSS.
- i** If a connection supports certain options, the option length (with **data offset** taken into consideration) should be deducted from an MSS value. For example, 20 bytes for MD5 digest (with **data offset** taken into consideration) should be subtracted from the MSS.

Related Configuration

Configuring MSS

- Run the **ip tcp mss max-segment-size** command in global configuration mode to set an MSS. It ranges from 68 to 1000 bytes. By default, the MSS is calculated based on MTU. If an MSS is configured, the effective MSS is the smaller one between the calculated MSS and the configured MSS.
- An excessively small MSS reduces transmission performance. You can promote TCP transmission by increasing the MSS. Choose an MSS value by referring to the interface MTU. If the former is bigger, TCP packets will be fragmented and transmission performance will be reduced.

7.3.5 Configuring MSS Value for SYN Packet

Working Principle

When a client initiates a TCP connection, it negotiates with the server on the total amount of data contained in a TCP segment through the MSS field in TCP SYN packets. The MSS value in the SYN packets indicates the largest amount of data that the server sends in a single and unfragmented piece.

For example, in the following figure, the MSS negotiated between a PC and a HTTP server is 1460, but TCP packets carrying 1460-byte data should be fragmented as they cannot directly pass R1 and R2 connected by a tunnel with an MTU of less than 1500. Modify the MSS value in SYN packets on interfaces (1) and (2) of R2 to enable TCP packets to pass R1 and R2.

Figure 7-3

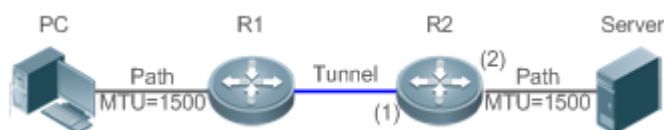

Related Configuration

Configuring MSS Value for TCPv4 SYN Packets

- By default, the MSS value in TCPv4 SYN packets is not modified.
- Run the **ip tcp adjust-mss max-segment-size** command in interface configuration mode to set an MSS, which ranges from 500 to 1460 bytes.
- To avoid packet fragmentation in the case of a small path MTU, you may configure an MSS for TCPv4 SYN packets. The MSS in TCPv4 SYN packets will change to the configured value once the device receives the packets. You may configure an MSS value with reference to the interface MTU.

i This configuration applies to a new connection but does not take effect for an existing TCP connection.

Configuring MSS Value for TCPv6 SYN Packets

- By default, the MSS value in TCPv6 SYN packets is not modified.
- Run the **ipv6 tcp adjust-mss max-segment-size** command in interface configuration mode to set an MSS for TCPv6 SYN packets, which ranges from 1220 to 1440 bytes.
- To avoid packet fragmentation in the case of a small path MTU, you may configure an MSS for TCPv4 SYN packets. The MSS in TCPv4 SYN packets will change to the configured value once the device receives the packets. You may configure an MSS value with reference to the interface MTU.

i This configuration applies to a new TCPv6 connection but does not take effect for an existing TCPv6 connection.

7.3.6 Path MTU Discovery

Working Principle

The Path MTU Discovery f stipulated in RFC1191 is used to discover the smallest MTU in a TCP path to avoid fragmentation, enhancing network bandwidth utilization. The process of TCPv4 Path MTU Discovery is described as follows:

1. The source sends TCP packets with the Don't Fragment (DF) bit set in the outer IP header.
2. If the outgoing interface MTU value of a router in the TCP path is smaller than the IP packet length, the packet will be discarded and an ICMP error packet carrying this MTU will be sent to the source.
3. Through parsing the ICMP error packet, the source knows the smallest MTU in the path (path MTU) is.
4. The size of subsequent data segments sent by the source will not surpass the MSS, which is calculated as follows: TCP MSS = Path MTU – IP header size – TCP header size.

Related Configuration

↳ Enabling Path MTU Discovery

By default, Path MTU Discovery is disabled.

Run the **ip tcp path-mtu-discovery** command to enable PMTUD in global configuration mode.

- i** In version 10.x, the configuration applies to both IPv4 TCP and IPv6 TCP. In version 11.0 or later, it applies to only IPv4 TCP. TCPv6 PMTUD is enabled permanently and cannot be disabled.

7.3.7 TCP Keepalive

Working Principle

You may enable TCP keepalive to check whether the peer works normally. If a TCP end does not send packets to the other end for a period of time (namely idle period), the latter starts sending keepalive packets successively to the former for several times. If no response packet is received, the TCP connection is considered inactive and then closed.

Related Configuration

↳ Enabling Keepalive

- By default, TCP keepalive is disabled.
- Run the **ip tcp keepalive [interval num1] [times num2] [idle-period num3]** command to in global configuration mode to enable TCP keepalive. See **Configuration** for parameter description.



- i** In version 10.x, the configuration applies to only IPv4 TCP. In version 11.0 or later, it applies to both IPv4 TCP and IPv6 TCP.

- i** The **service tcp-keepalives-in** command is used in version 10.x to enable keepalive on the TCP server. It is disused but compatible in version 11.0. If this command is executed, it will be converted to the **ip tcp keepalive [interval num1] [times num2] [idle-period num3]** command.

- i** The **service tcp-keepalives-out** command is used in version 10.x to enable keepalive on the TCP client. It is disused but compatible in version 11.0. If this command is executed, it will be converted to the **ip tcp keepalive [interval num1] [times num2] [idle-period num3]** command.

 This command applies to both TCP server and client.

7.4 Configuration

| Configuration | Description and Command | |
|--|---|--|
| Optimizing TCP Performance |  (Optional) It is used to optimize TCP connection performance. | |
| | ip tcp synwait-time | Configures a timeout for TCP connection. |
| | ip tcp window-size | Configures a TCP window size. |
| | ip tcp send-reset | Configures the sending of TCP reset packets after receiving port unreachable messages. |
| | ip tcp mss | Configures an MSS for TCP connection. |
| | ip tcp adjust-mss | Configures an MSS value for the TCPv4 SYN packets |
| | ipv6 tcp adjust-mss | Configures an MSS value for TCPv6 SYN packets. |
| | ip tcp path-mtu-discovery | Enables Path MTU Discovery. |
| Detecting TCP Connection Exception |  (Optional) It is used to detect whether the peer works normally. | |
| | ip tcp keepalive | Enables TCP keepalive. |

7.4.1 Optimizing TCP Performance

Configuration Effect

- Ensure optimal TCP performance and prevent fragmentation.

Notes

N/A

Configuration Steps

↘ [Configuring SYN Timeout](#)

- Optional.
- Configure this on the both ends of TCP connection.

↘ [Configuring TCP Window Size](#)

- Optional.
- Configure this on the both ends of TCP connection.

↘ [Configuring the Sending of TCP Reset Packets After Receiving Port Unreachable Messages.](#)

- Optional.
- Configure this on the both ends of TCP connection.

↘ Configuring MSS

- Optional.
- Configure this on the both ends of TCP connection.

↘ Configuring MSS Value for TCPv4 SYN Packets

- Optional.
- If the MTU between two routers in TCP transmission is small, you may configure an MSS value on the routers.

↘ Configuring MSS Value for TCPv6 SYN Packets

- Optional.
- If the MTU between two routers in TCPv6 transmission is small, you may configure an MSS value on the routers.

↘ Enabling Path MTU Discovery

- Optional.
- Configure this on the both ends of TCP connection.

Verification

N/A

Related Commands

↘ Configuring SYN Timeout

| | |
|------------------------------|---|
| Command | <code>ip tcp synwait-time seconds</code> |
| Parameter Description | <i>seconds</i> : Indicates SYN packet timeout. It ranges from 5 to 300 seconds. The default is 20 seconds. |
| Command Mode | Global configuration mode |
| Usage Guide | In case of SYN flooding, shortening SYN timeout reduces resource consumption. However, it does not work in continuous SYN flooding. When a device actively makes a request for a connection with an external device, through telnet for example, shortening SYN timeout reduces user's wait time. You may prolong SYN timeout properly on a poor network. |

↘ Configuring TCP Window Size

| | |
|------------------------------|---|
| Command | <code>ip tcp window-size size</code> |
| Parameter Description | <i>size</i> : Indicates a TCP window size. It ranges from 128 to (65535 << 14) bytes. The default is 65535 bytes. |
| Command | Global configuration mode |

| | |
|--------------------|-----|
| Mode | |
| Usage Guide | N/A |

↘ Configuring the Sending of TCP Reset Packets After Receiving Port Unreachable Messages

| | |
|--------------------|---|
| Command | ip tcp send-reset |
| Parameter | N/A |
| Description | |
| Command | Global configuration mode |
| Mode | |
| Usage Guide | By default, TCP reset packet sending upon receiving port unreachable messages is enabled. |

↘ Configuring MSS

| | |
|--------------------|--|
| Command | ip tcp mss <i>max-segment-size</i> |
| Parameter | <i>max-segment-size</i> : Indicates the maximum segment size. It ranges from 68 to 10000 bytes. By default, the MSS is calculated based on MTU. |
| Description | |
| Command | Global configuration mode |
| Mode | |
| Usage Guide | This command defines the MSS for a TCP communication to be established. The negotiated MSS for a new connection should be smaller than this MSS. If you want to reduce the MSS, run this command. Otherwise, do not perform the configuration. |

↘ Configuring MSS Value for TCPv4 SYN Packets

| | |
|--------------------|--|
| Command | ip tcp adjust-mss <i>max-segment-size</i> |
| Parameter | <i>max-segment-size</i> : Indicates the maximum segment size, ranging from 500 to 1460 bytes |
| Description | |
| Command | Interface configuration mode |
| Mode | |
| Usage Guide | N/A |

↘ Configuring MSS Value for TCPv6 SYN Packet

| | |
|--------------------|---|
| Command | ipv6 tcp adjust-mss <i>max-segment-size</i> |
| Parameter | <i>max-segment-size</i> : indicates the maximum segment size, ranging from 1220 to 1440 bytes |
| Description | |
| Command | Interface configuration mode |
| Mode | |
| Usage Guide | N/A |

↘ Configuring Path MTU Discovery

| | |
|------------------|--|
| Command | ip tcp path-mtu-discovery [age-timer <i>minutes</i> age-timer infinite] |
| Parameter | age-timer <i>minutes</i> : Indicates the interval for a new probe after a path MTU is discovered. It ranges from 10 |

| | |
|---------------------|---|
| Description | to 30 minutes. The default is 10 minutes. age-timer infinite: No probe is implemented after a path MTU is discovered. |
| Command Mode | Global configuration mode |
| Usage Guide | The PMTUD is an algorithm documented in RFC1191 aimed to improve bandwidth utilization. When the TCP is applied to bulk data transmission, this function may facilitate transmission performance. If the MSS used for the connection is smaller than what the peer connection can handle, a larger MSS is tried every time the age timer expires. The age timer is a time interval for how often TCP estimates the path MTU with a larger MSS. The discovery process is stopped when either the send MSS is as large as the peer negotiated, or the user has disabled the timer on the router. You may turn off the timer by setting it to infinite . |

Configuration Example

▾ Enabling Path MTU Discovery

| | |
|----------------------------|---|
| Configuration Steps | Enable PMTUD for a TCP connection. Adopt the default age timer settings. |
| | <pre>Ruijie# configure terminal Ruijie(config)# ip tcp path-mtu-discovery Ruijie(config)# end</pre> |
| Verification | Run the show tcp pmtu command to display the IPv4 TCP PMTU. |
| | <pre>Ruijie# show tcp pmtu Number Local Address Foreign Address PMTU 1 192.168.195.212.23 192.168.195.112.13560 1440</pre> |
| | Run the show ipv6 tcp pmtu command to display the IPv6 TCP PMTU. |
| | <pre>Ruijie# show ipv6 tcp pmtu Number Local Address Foreign Address PMTU 1 1000::1:23 1000::2:13560 1440</pre> |

Common Errors

N/A

7.4.2 Detecting TCP Connection Exception

Configuration Effect

- Check whether the peer works normally.

Notes

N/A

Configuration Steps

▾ Enabling TCP Keepalive

- Optional.

Verification

N/A

Related Commands

▾ Enabling TCP Keepalive

| | |
|------------------------------|---|
| Command | ip tcp keepalive [interval <i>num1</i>] [times <i>num2</i>] [idle-period <i>num3</i>] |
| Parameter Description | <p>interval <i>num1</i>: Indicates the interval to send keepalive packets. Ranging from 1 to 120 seconds. The default is 75 seconds.</p> <p>times <i>num2</i>: Indicates the maximum times for sending keepalive packets. It ranges from 1 to 10. The default is 6.</p> <p>idle-period <i>num3</i>: Indicates the time when the peer sends no packets to the local end, It ranges from 60 to 1800 seconds. The default is 15 minutes.</p> |
| Command Mode | Global configuration mode |
| Usage Guide | <p>You may enable TCP keepalive to check whether the peer works normally. The function is disabled by default.</p> <p>Suppose a user enables TCP keepalive function with the default interval, times and idle period settings. The user does not receive packets from the other end within 15 minutes and then starts sending Keepalive packets every 75 seconds for 6 times. If the user receives no TCP packets, the TCP connection is considered inactive and then closed.</p> |

Configuration Example

▾ Enabling TCP Keepalive

| | |
|----------------------------|---|
| Configuration Steps | <p>Enable TCP keepalive on a device with interval and idle-period set to 3 minutes and 60 seconds respectively. If the user receives no TCP packets from the other end after sending keepalive packets four times, the TCP connection is considered inactive.</p> |
| | <pre>Ruijie# configure terminal Ruijie(config)# ip tcp keepalive interval 60 times 4 idle-period 180 Ruijie(config)# end</pre> |
| | |

| | |
|---------------------|---|
| Verification | A user logs in to a device through telnet, and then shuts down the local device. Run the show tcp connect command on the remote device to observe when IPv4 TCP connection is deleted. |
|---------------------|---|

Common Errors

N/A

7.5 Monitoring

Displaying

| Description | Command |
|--|--|
| Displays basic information on IPv4 TCP connection. | show tcp connect [local-ip <i>a.b.c.d</i>] [local-port <i>num</i>] [peer-ip <i>a.b.c.d</i>] [peer-port <i>num</i>] |
| Displays IPv4 TCP connection statistics. | show tcp connect statistics |
| Displays IPv4 TCP PMTU. | show tcp pmtu [local-ip <i>a.b.c.d</i>] [local-port <i>num</i>] [peer-ip <i>a.b.c.d</i>] [peer-port <i>num</i>] |
| Displays IPv4 TCP port information. | show tcp port [<i>num</i>] |
| Displays basic information on IPv6 TCP connection. | show ipv6 tcp connect [local-ipv6 <i>X:X:X:X::X</i>] [local-port <i>num</i>] [peer-ipv6 <i>X:X:X:X::X</i>] [peer-port <i>num</i>] |
| Displays IPv6 TCP connection statistics. | show ipv6 tcp connect statistics |
| Displays IPv6 TCP PMTU. | show ipv6 tcp pmtu [local-ipv6 <i>X:X:X:X::X</i>] [local-port <i>num</i>] [peer-ipv6 <i>X:X:X:X::X</i>] [peer-port <i>num</i>] |
| Displays IPv6 TCP port information. | show ipv6 tcp port [<i>num</i>] |

Debugging

 System resources are occupied when debugging information is output. Therefore, disable debugging immediately after use.

| Description | Command |
|--|--|
| Displays the debugging information on IPv4 TCP packets. | debug ip tcp packet [in out] [local-ip <i>a.b.c.d</i>] [peer-ip <i>a.b.c.d</i>] [global] [local-port <i>num</i>] [peer-port <i>num</i>] [deeply] |
| Displays the debugging information on IPv4 TCP connection. | debug ip tcp transactions [local-ip <i>a.b.c.d</i>] [peer-ip <i>a.b.c.d</i>] [local-port <i>num</i>] [peer-port <i>num</i>] |
| Displays the debugging information on IPv6 TCP packets. | debug ipv6 tcp packet [in out] [local-ipv6 <i>X:X:X:X::X</i>] [peer-ipv6 <i>X:X:X:X::X</i>] [global] [local-port <i>num</i>] [peer-port <i>num</i>] [deeply] |
| Displays the debugging information on IPv6 TCP connection. | debug ipv6 tcp transactions [local-ipv6 <i>X:X:X:X::X</i>] [peer-ipv6 <i>X:X:X:X::X</i>] [local-port <i>num</i>] [peer-port <i>num</i>] |

8 Configuring IPv4/IPv6 REF

8.1 Overview

On products incapable of hardware-based forwarding, IPv4/IPv6 packets are forwarded through the software. To optimize the software-based forwarding performance, Ruijie introduces IPv4/IPv6 express forwarding through software (Ruijie Express Forwarding, namely REF).

REF maintains two tables: forwarding table and adjacency table. The forwarding table is used to store route information. The adjacency table is derived from the ARP table and IPv6 neighbor table, and it contains Layer 2 rewrite(MAC) information for the next hop..

REF is used to actively resolve next hops and implement load balancing.

Protocols and Standards

N/A

8.2 Applications

| Application | Description |
|--------------------------------|---|
| Load Balancing | During network routing, when a route prefix is associated with multiple next hops, REF can implement load balancing among the multiple next hops. |

8.2.1 Load Balancing

Scenario

As shown in Figure 8-1, a route prefix is associated with three next hops on router A, namely, link 1, link 2, and link 3. By default, REF implements load balancing based on the destination IP address. Load balancing can be implemented based on the source IP address and destination IP address as well.

Figure 8-1

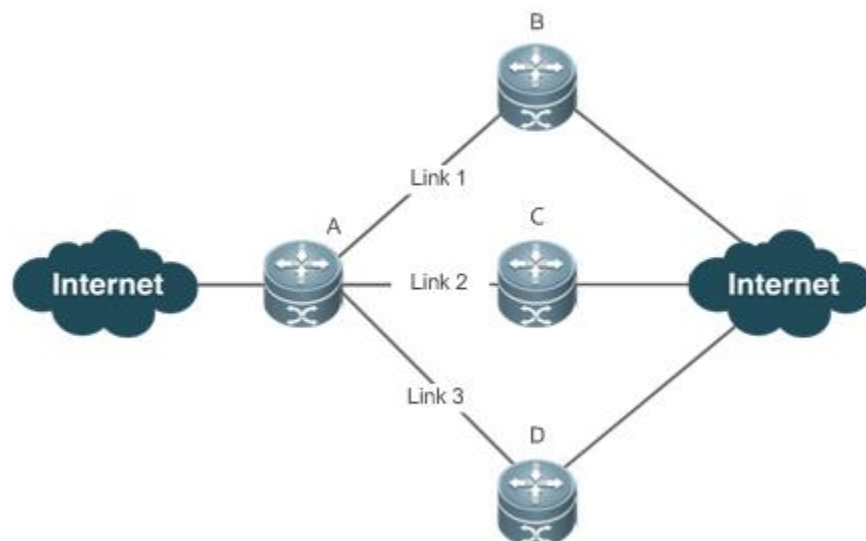

| | |
|----------------|--|
| Remarks | A is a router that runs REF. B, C and D are forwarding devices. |
|----------------|--|

Deployment

- Run REF on router A.

8.3 Features

Basic Concepts

IPv4/IPv6 REF involves the following basic concepts:

↳ Routing table

An IPv4/IPv6 routing table stores routes to the specific destinations and contains the topology information. During packet forwarding, IPv4/IPv6 REF selects packet transmission paths based on the routing table.

↳ Adjacent node

An adjacent node contains output interface information about routed packets, for example, the next hop, the next component to be processed, and the link layer encapsulation. When a packet is matched with an adjacent node, the packet is directly encapsulated and then forwarded. For the sake of query and update, an adjacent node table is often organized into a hash table. To support routing load balancing, the next hop information is organized into a load balance entry. An adjacent node may not contain next hop information. It may contain indexes of next components (such as other line cards and multi-service cards) to be processed.

↳ Active resolution

REF supports next hop resolution. If the MAC address of the next hop is unknown, REF will actively resolve the next hop. IPv4 REF requests the ARP module for next hop resolution while IPv6 REF applies the ND module to resolution.

↘ Packet forwarding path

Packets are forwarded based on their IPv4/IPv6 addresses. If the source and destination IPv4/IPv6 addresses of a packet are specified, the forwarding path of this packet is determined.

8.3.1 Load Balancing Policies

Load balancing is configured to distribute traffic load among multiple network links.

Working Principle

REF supports two load balancing modes. In the REF model, a route prefix is associated with multiple next hops, in other words, it is a multi-path route. The route will be associated with a load balance table and implement weight-based load balancing. When an IPv4/IPv6 packet is matched with a load balance entry based on the longest prefix match, REF performs hash calculation based on the IPv4/IPv6 address of the packet and selects a path to forward the packet.

IPv4/IPv6 REF supports two kinds of load balancing policies: load balancing based on destination IP address, and load balancing based on the source and destination IP addresses.

Related Configuration

↘ Configuring Load Balancing Based on IPv4 Source and Destination Addresses

- By default, load balancing is implemented based on the IPv4 destination addresses.
- Run the **ip ref load-sharing original** command to configure the load balancing.
- After the configuration, load balancing is implemented based on the IPv4 source and destination addresses.

↘ Configuring Load Balancing Based on IPv6 Source and Destination Addresses

- By default, load balancing is implemented based on the IPv6 destination addresses.
- Run the **ipv6 ref load-sharing original** command to configure the load balancing.
- After the configuration, load balancing is implemented based on the IPv6 source and destination addresses.

8.4 Configuration

| Configuration | Description and Command | |
|---|---|--|
| Configuring Load Balancing Policies |  Optional. | |
| | ip ref load-sharing original | Enables the load balancing algorithm based on IPv4 source and destination addresses. |
| | ipv6 ref load-sharing original | Enables the load balancing algorithm based on IPv6 source and destination addresses. |

8.4.1 Configuring Load Balancing Policies

Configuration Effect

REF supports the following two kinds of load balancing policies:

- Destination address-based load balancing indicates performing hash calculation based on the destination address of the packet. The path with a greater weight is more likely to be selected. This policy is used by default.
- Implementing load balancing based on the source and destination addresses indicates performing hash calculation based on the source and destination addresses of the packet. The path with a greater weight is more likely to be selected.

Notes

N/A

Configuration Steps

- Optional.
- Perform this configuration if you want to implement load balancing based on the source and destination IP addresses.
- Perform this configuration on a router that connects multiple links.

Verification

Run the **show ip ref adjacency statistic** command to display the IPv4 load balancing policy.

Run the **show ipv6 ref adjacency statistic** command to display the IPv6 load balancing policy.

Related Commands

↘ Configuring Load Balancing Based on IPv4 Source and Destination Addresses

| | |
|------------------------------|-------------------------------------|
| Command | ip ref load-sharing original |
| Parameter Description | N/A |
| Command Mode | Global configuration mode |
| Usage Guide | N/A |

↘ Configuring Load Balancing Based on IPv6 Source and Destination Addresses

| | |
|------------------------------|---------------------------------------|
| Command | ipv6 ref load-sharing original |
| Parameter Description | N/A |
| Command Mode | Global configuration mode |
| Usage Guide | N/A |

Configuration Example

Configuring Load Balancing Based on Source and Destination IP Addresses

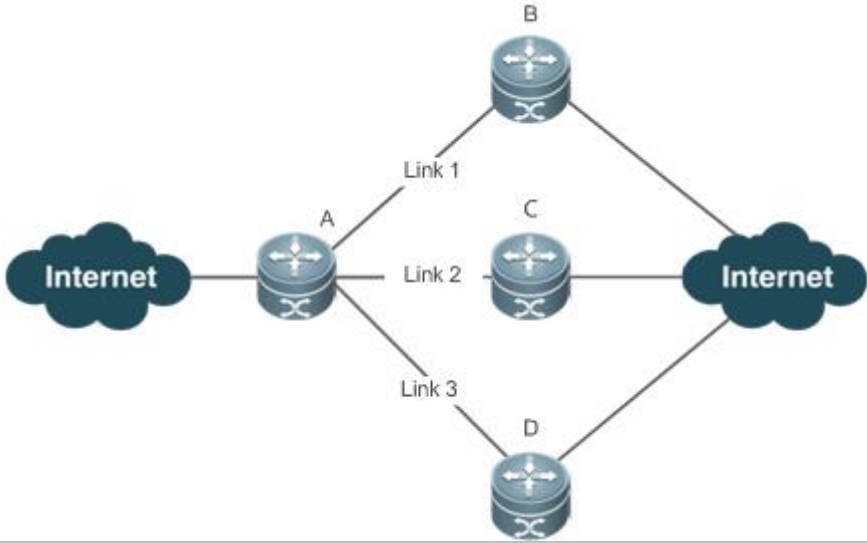
| | |
|---------------------------------------|--|
| <p>Scenario Figure 8-2</p> |  |
| | <p>A route prefix is associated with three next hops on router A, namely, link 1, link 2, and link 3.</p> |
| <p>Configuration Steps</p> | <p>Configure load balancing based on IPv4 source and destination IP addresses on router A.</p> |
| <p>A</p> | <pre>A#configure terminal Enter configuration commands, one per line. End with CNTL/Z. A(config)#ip ref load-sharing original</pre> |
| <p>Verification</p> | |
| | <pre>A #show ip ref adjacency statistics adjacency balance table statistic: source-dest-address load-sharing balance: 0 adjacency node table statistic: total : 3 local : 1 glean : 0 forward: 0 discard: 0 mcast : 1</pre> |

| | |
|--|----------------------------------|
| | <p>punt : 1</p> <p>bcast : 0</p> |
|--|----------------------------------|

8.5 Monitoring

Displaying REF Packet Statistics

REF packet statistics includes the number of forwarded packets and the number of packets discarded due to various causes. You can determine whether packets are forwarded as expected by displaying and clearing REF packet statistics.

| Command | Description |
|---|--------------------------------------|
| show ip ref packet statistics | Displays IPv4 REF packet statistics. |
| clear ip ref packet statistics | Clears IPv4 REF packet statistics. |
| show ipv6 ref packet statistics | Displays IPv6 REF packet statistics. |
| clear ipv6 ref packet statistics | Clears IPv6 REF packet statistics. |

Displaying Adjacency Information

You can run the following commands to display adjacency information:

| Command | Description |
|---|--|
| show ip ref adjacency [glean local <i>ip-address</i> {interface <i>interface_type interface_number</i> } discard statistics] | Displays the gleaned adjacencies, local adjacencies, adjacencies of a specified IP address, adjacencies associated with a specified interface, and all adjacent nodes in IPv4 REF. |
| show ipv6 ref adjacency [glean local <i>ipv6-address</i> (interface <i>interface_type interface_number</i>) discard statistics] | Displays the gleaned adjacencies, local adjacencies, adjacencies of a specified IPv6 address, adjacencies associated with a specified interface, and all adjacent nodes in IPv6 REF. |

Displaying Active Resolution Information

You can run the following commands to display next hops to be resolved:

| Command | Description |
|-----------------------------------|--|
| show ip ref resolve-list | Displays the next hop to be resolved . |
| show ipv6 ref resolve-list | Displays the next hop to be resolved. |

Displaying Packet Forwarding Path Information

Packets are forwarded based on their IPv4/IPv6 addresses. If the source and destination IPv4/IPv6 addresses of a packet are specified, the forwarding path of this packet is determined. Run the following commands and specify the IPv4/IPv6 source and destination addresses of a packet. The forwarding path of the packet is displayed, for example, the packet is discarded, submitted to a CPU, or forwarded. Furthermore, the interface that forwards the packet is displayed.

| Command | Description |
|---|--|
| show ip ref exact-route <i>source-ipaddress dest_ipaddress</i> | Displays the forwarding path of a packet. oob indicates out-of-band management network. |
| show ipv6 ref exact-route <i>src-ipv6-address dst-ipv6-address</i> | Displays the forwarding path of an IPv6 packet. oob indicates out-of-band, management network. |

Displaying Route Information in an REF Table

Run the following commands to display the route information in an REF table:

| Command | Description |
|---|---|
| show ip ref route [default { <i>ip mask</i> }] statistics] | Displays route information in the IPv4 REF table. The parameter default indicates a default route. oob indicates out-of-band management network. |
| show ipv6 ref route [default statistics <i>prefix/len</i>] | Displays route information in the IPv6 REF table. The parameter default indicates a default route. oob indicates out-of-band management network. |

9 Configuring NAT

9.1 Overview

Network Address Translation (NAT) is a process of translating the IP address in the header of an IP data packet into another IP address. In practice, NAT enables private networks that use unregistered IP addresses to access public networks. This way of using a small number of public IP addresses to represent substantial private IP addresses implements IP address conservation.

Protocols and Standards

- RFC 1631: The IP Network Address Translator (NAT)
- RFC 2663: IP Network Address Translator (NAT) Terminology and Considerations
- RFC 2391: Load Sharing using IP Network Address Translation (LSNAT)
- RFC 4008: Definitions of Managed Objects for Network Address Translators (NAT)

9.2 Applications

| Application | Description |
|---|--|
| Intranet Users' Access to the Internet | NAT allows an intranet to communicate with the Internet by translating an inside private IP address into a globally unique IP address. |
| External Users' Access to an Intranet Server | NAT allows external networks to access internal devices by mapping one or more internal hosts to a network server. |
| Source/Destination Address Translation for Internal Users | When two private networks to interconnect with each other are configured with the same IP address or the same global IP address is allocated to both a private network and a public network, the two network hosts with the same IP address cannot communicate. NAT allows overlapping networks to communicate.. |
| Intranet Server Load Balancing | When the TCP traffic load of an intranet host is excessively heavy, multiple hosts are deployed for TCP service load balancing. In this case, NAT may be used to attain this objective. |

9.2.1 Intranet Users' Access to the Internet

Scenario

A PC is located in an intranet while a server is located in an extranet, as shown in Figure 10-1. In view of IP address depletion, only one or a few public IP addresses are allocated to the entire campus network. An egress router belongs to the intranet, and connects to the extranet. The basic NAT function is required on the egress router to allow the intranet PC to access the extranet server.

Figure 9-1



i The egress router connects both the intranet and the extranet.

Corresponding Protocols

- Configure an inside interface and an outside interface for NAT.
- Configure static inside source address translation on the egress router.

9.2.2 External Users' Access to an Intranet Server

Scenario

A PC is located in an extranet while a server (such as a Web server) is located in an intranet, as shown in Figure 9-2. In view of IP address depletion, only one public IP address is allocated to the entire campus network. An egress router belongs to the intranet, and connects to the extranet. The Network Address and Port Translation (NAPT) function is required on the egress router to enable the PC to access the intranet server; that is, port mapping applies to the Web service port.

Figure 9-2

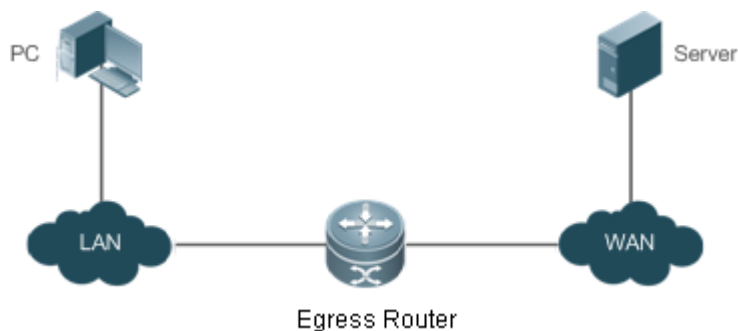

i The egress router connects both the intranet and the extranet.
The server is deployed in the intranet.

Corresponding Protocols

- Configure an inside interface and an outside interface for NAT.
- Configure server port address translation rules on the egress router.

9.2.3 Source/Destination Address Translation for Internal Users

Scenario

PC 1 is located in private network 1 while PC 2 is located in private network 2, as shown in Figure 10-3. Because the two private networks are separately managed, address overlapping occurs in their IP network segments. For example, the IP addresses of PC 1 and PC 2 are configured in the same network segment 192.168.1.0/24. An egress router is located between private networks 1 and 2. The NAT function needs to be enabled on the egress router, so that PC 1 and PC 2 can access each other.

Figure 9-3

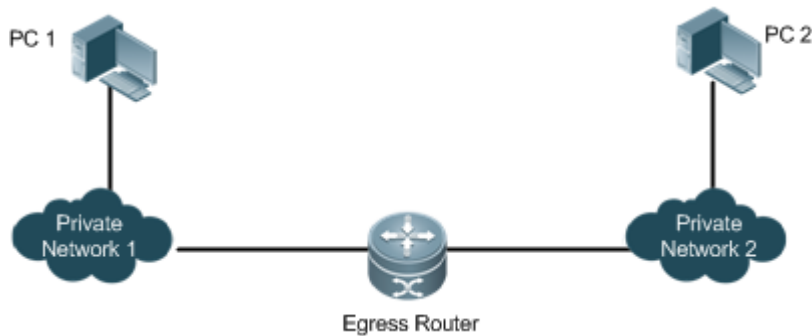

i The egress router connects both private networks.

Corresponding Protocols

- Configure an inside interface and an outside interface for NAT.
- Configure dynamic translation of the inside source address on the egress router.
- Configure dynamic translation of the outside source address on the egress router.

9.2.4 Intranet Server Load Balancing

Scenario

Server 1 and Server 2 are located in an intranet, and form a cluster, as shown in Figure 9-4. A PC is located in an extranet. In view of IP address depletion, only one public IP address is allocated to the entire campus network. An egress router belongs to the intranet, and connects to the extranet. The egress router needs to distribute the server access traffic of the external user to the two servers; therefore, the NAT load balancing function needs to be enabled on the egress router.

Figure 9-4

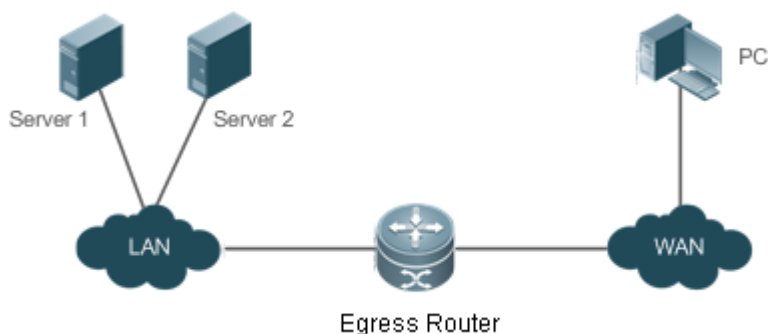

- i** The egress router connects both the intranet and the extranet.
The servers are deployed in the intranet.

Corresponding Protocols

- Configure an inside interface and an outside interface for NAT.
- Configure TCP load balancing using NAT on the egress router.

9.2.5 Port-Range-based QoS

Scenario

STAs access the wired network via the AP configured with NAT. In the wired links, QoS priorities are expected to be allocated to STAs according to their user types. For an STA, its user type is indicated by the mapped port number of its streams. For example, if the mapped port number falls between 1 and 20000, the STA is recognized as a Level 0 user. If the mapped port number falls between 20001 and 40000, the STA is recognized as a Level 1 user. If the mapped port number falls between 40001 and 60000, the STA is recognized as a Level 2 user. Thus, in the uplink, after the source port is mapped, if its mapped port number is:

- between 1 and 20000, the streams are from a Level 0 STA, so QoS for Level 0 STA is applied;
- between 20001 and 40000, the streams are from a Level 1 STA, so QoS for Level 1 STA is applied;
- between 40001 and 60000, the streams are from a Level 2 STA, so QoS for Level 2 STA is applied.

In the downlink, after the destination port is mapped, if its mapped port number is:

- between 1 and 20000, the streams are from a Level 0 STA, so QoS for Level 0 STA is applied;
- between 20001 and 40000, the streams are from a Level 1 STA, so QoS for Level 1 STA is applied;
- between 40001 and 60000, the streams are from a Level 2 STA, so QoS for Level 2 STA is applied.

Figure 9-5

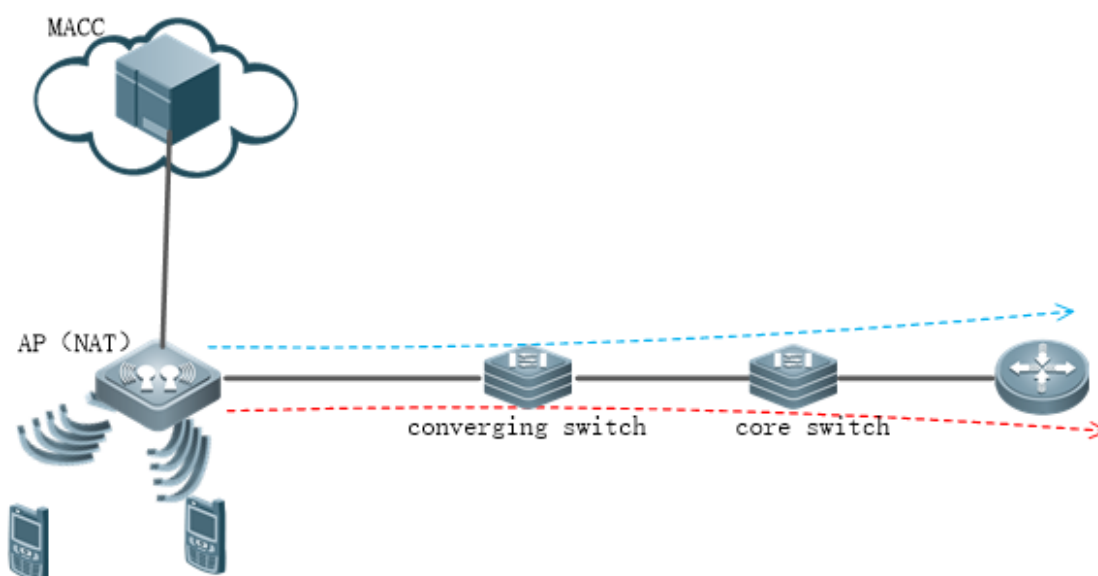

Deployment

- Configure the NAT interface on the intranet and extranet ports on the AP.
- Configure port-range-based QoS on the AP.
- Configure QoS policies on the switches.

9.3 Features

Basic Concepts

Private Address and Public Address

A private address is the IP address of an intranet or an intranet host, whereas a public address is an IP address globally unique on the Internet. The Internet Assigned Numbers Authority (IANA) has stipulated the following IP addresses for use on private networks, which cannot be allocated for use on the Internet but can be used inside any institution or corporation.

Class A private addresses: 10.0.0.0 to 10.255.255.255

Class B private addresses: 172.16.0.0 to 172.31.255.255

Class C private addresses: 192.168.0.0 to 192.168.255.255

NAT was initially designed to enable a private network to access a public network. Later it was extended to implement address translation for mutual access between any two networks. In this document, the two networks are called an intranet and an extranet. In general, a private network is an intranet, and a public network is an extranet.

Static NAT

Static NAT allows one-to-one permanent mappings between inside local addresses and inside global addresses. Static NAT is important when an extranet needs to access internal hosts via a fixed global routable address.

Dynamic NAT

Dynamic NAT establishes temporary mapping relationships between inside local addresses and inside global addresses. The temporary mapping relationships will be removed when unused in a certain period of time. Dynamic NAT can be configured in the following case: An intranet accesses extranet services only but does not provide services, and the number of intranet hosts is greater than the number of global IP addresses.

Overview

| Feature | Description |
|---|---|
| Basic NAT | This feature translates inside private addresses into globally unique addresses, so that the intranet and the public network can communicate with each other. |
| NAPT | This feature maps multiple inside local addresses to one inside global address, so as to resolve the problem of IP address depletion. |
| Overlapping NAT | This feature enables overlapping networks to communicate. |
| TCP Load Balancing | This feature resolves the problem of TCP traffic overload. |
| Constructing a Local Server | This feature enables extranet to access the local server. |

| | |
|---------------------|--|
| ALG | NAT changes only the header of an IP packet but not the payload of a specific application protocol. Therefore, the Application Level Gateway (ALG) is introduced to support application layer protocols. |
|---------------------|--|

9.3.1 Basic NAT

NAT is required for an intranet to communicate with an extranet by translating an inside private IP address into a globally unique IP address. You can configure static or dynamic NAT or both to implement interconnection and interworking.

Working Principle

An IP packet sent by an intranet host (192.168.1.2) to an extranet server (8.8.8.8) reaches an NAT device.

The NAT device checks the content of the IP packet, and finds that the IP packet is destined to an extranet. Therefore, the NAT device translates the private IP address 192.168.1.2 in the source IP address field of the IP packet into a public IP address 30.1.1.1 routable on the Internet, sends the IP packet to the extranet server, and at the same time records the mapping in its own NAT table.

The extranet server returns a response packet (in which the initial destination IP address is 30.1.1.1) to the intranet user. When the response packet reaches the NAT device, the NAT device checks the content of the response packet, looks up the mapping record in the NAT table, and replaces the initial destination IP address with the inside private IP address 192.168.1.2.

The above NAT process is transparent to terminals, such as the host and the server shown in the preceding figures. In the point of view of the extranet server, the IP address of the intranet host is 30.1.1.1 and the extranet server itself does not know the existence of the IP address 192.168.1.2 at all. Therefore, NAT "hides" the private network of an enterprise.

Basic NAT includes static NAT and dynamic NAT.

Related Configuration

▾ Configuring NAT Interfaces

- An interface is not an NAT interface by default.
- Use the **ip nat { inside | outside }** command to configure the interfaces as connected to the inside and outside.
- NAT does not work on a data packet unless a route exists between the outside interface and the inside interface and the data packet meets a certain rule. Therefore, at least one inside interface and one outside interface need to be configured.

▾ Configuring Static NAT

- Static NAT is not configured by default.
- Use the **ip nat inside source static** local-address global-address [**permit-inside**] [**netmask** mask] [**match** interface] command to configure static one-to-one NAT mapping.

▾ Configuring Dynamic NAT

- Dynamic NAT is not configured by default.
- Use the **ip nat inside source list** access-list-number **pool** address-pool command to configure dynamic NAT mapping.

9.3.2 NAT

In general, traditional NAT is one-to-one address mapping, which, however, cannot meet the requirements of all hosts in intranets to communicate with extranets. For example, when the intranet is in short of global IP addresses or even does not apply for global IP addresses but has only one global IP address to connect to an Internet Service Provider (ISP) while a large number of hosts in the intranet need to access the Internet, NAT is required in this scenario.

Multiple inside local addresses can map to one inside global address using NAT.

Working Principle

NAPT, also known as multiple-to-one address translation, allows multiple inside addresses to map to one public address. NAPT maps both IP addresses and port numbers; that is, the source addresses of data packets from different inside addresses can map to the same public address, but their port numbers are translated into different port numbers of the public address so that the same address can still be shared. NAPT is translation between "private IP address + Port number" and "Public IP address + Port number".

Static NAT

In general, static NAT is used to map the specified port on a specified host in an intranet to the specified port of a global address. In comparison, as mentioned previously, static NAT maps an internal host to a global address. Static NAT is applicable to intranet hosts that provide the information service. Static NAT provides a permanent one-to-one "IP address + Port" mapping relationship.

Dynamic NAT

Dynamic NAT is applicable to intranet hosts that only access extranet services but do not provide any information service. Dynamic NAT provides a temporary one-to-one "IP address + Port" mapping relationship.

Related Configuration

Configuring NAT Interfaces

- An interface is not an NAT interface by default.
- Use the **ip nat { inside | outside }** command to configure the interfaces as connected to the inside and outside.
- NAT does not work on a data packet unless a route exists between the outside interface and the inside interface and the data packet meets a certain rule. Therefore, at least one inside interface and one outside interface need to be configured.

Configuring Static NAT

- Static NAT is not configured by default.
- Use the **ip nat inside source static local-ip interface interface [permit-inside]** command to configure static one-to-one NAT mapping.

Configuring Dynamic NAT

- Dynamic NAT is not configured by default.
- Use the **ip nat inside source list access-list-number { [pool address-pool] | [interface interface-type interface-number] } overload** command to configure dynamic NAT mapping. For NAT, generally only one IP

address is defined in the address pool, and one IP address supports up to 64,512 times of NAT. If one IP address is not enough, multiple IP addresses can be defined in the address pool.

9.3.3 Overlapping NAT

When the same IP address is allocated to two private networks to interconnect with each other or the same global IP address is allocated to a private network and a public network, this situation is called address overlapping. Two overlapping network hosts cannot communicate, because both hosts consider that the peer host is in the local network. Overlapping NAT is especially designed to implement the communications between two networks with the same IP address. After overlapping NAT is configured, an extranet host address will be represented as another host address in the intranet, and vice versa.

Working Principle

For mutual access between an intranet and an extranet with the same IP address, NAT needs to translate the inside address into a unique outside address. In addition, NAT needs to translate the outside address that overlaps with the inside address into another unique inside address.

Related Configuration

▾ **Configuring NAT Interfaces**

- An interface is not an NAT interface by default.
- Use the **ip nat { inside | outside }** command to configure the interfaces as connected to the inside and outside.
- NAT does not work on a data packet unless a route exists between the outside interface and the inside interface and the data packet meets a certain rule. Therefore, at least one inside interface and one outside interface need to be configured.

▾ **Configuring Inside Source Address Translation**

- Inside source address translation is not configured by default.
- Static/dynamic basic NAT or static/dynamic NAT can be used for inside source address translation. For details, see the "Basic NAT" and "NAT" sections.

▾ **Configuring Static Translation of Outside Source Address**

- Static translation of outside source address is not configured by default.
- Use the **ip nat outside source static *global-address local-address*** command to configure static translation of outside source address.

▾ **Configuring Dynamic Translation of Outside Source Address**

- Dynamic translation of outside source address is not configured by default.
- Use the **ip nat outside source list *access-list-number pool address-pool*** command to configure dynamic translation of outside source address.

▾ **Configuring an ACL**

- No ACL is configured by default.

- Use the **ip access-list { extended | standard } { id | name }** command or the **access-list** command to configure an ACL.

↘ **Configuring a Static Route**

- Mandatory configuration.
- Use the **ip route network net-mask { ip-address | interface [ip-address] } [distance] [tag tag] [permanent | track object-number] [weight number] [description description-text] [disabled | enabled] [global]** command to configure a static route, which is used to specify the network egress after inside destination address translation.

9.3.4 TCP Load Balancing

When the TCP traffic load of an intranet host is excessively heavy, multiple hosts can be deployed to implement TCP service load balancing. In this case, NAT can be used to attain this objective.

Working Principle

Create a virtual host with NAT to provide the TCP service. The virtual host maps to multiple physical hosts. Then the virtual host polls and replaces destination addresses, so as to implement traffic load distribution.

Related Configuration

↘ **Configuring NAT Interfaces**

- An interface is not an NAT interface by default.
- Use the **ip nat { inside | outside }** command to configure the interfaces as connected to the inside and outside.
- NAT does not work on a data packet unless a route exists between the outside interface and the inside interface and the data packet meets a certain rule. Therefore, at least one inside interface and one outside interface need to be configured.

↘ **Configuring the Address Pool**

- No address pool is configured by default.
- Use the **ip nat pool address-pool start-address end-address { netmask mask | prefix-length prefix-length }** command to configure an IP address pool for NAT.

↘ **Configuring the ACL**

- No ACL is configured by default.
- Use the **access-list access-list-number permit ip-address wildcard** command to configure a destination-based ACL. Note that the ACL must be configured as an extended ACL based on destination IP address matching.

↘ **Configuring Inside Destination Address Translation**

- Inside destination address translation is not configured by default.
- Use the **ip nat inside destination list access-list-number pool address-pool** command to configure inside destination address translation. This configuration takes effect on TCP traffic only but not on other traffic, unless additional NAT configuration has been performed.

9.3.5 Constructing a Local Server

A user has deployed three servers (an FTP server, a Web server, and an Email server) in an intranet, and hopes that network hosts in a WAN can access the three servers while common users of the intranet can set the gateway as a device to provide Internet access.

Working Principle

Map one or more internal hosts to a network server, so that users on the WAN obtain corresponding services from the network server.

Related Configuration

▾ **Configuring NAT Interfaces**

- An interface is not an NAT interface by default.
- Use the **ip nat { inside | outside }** command to configure the interfaces as connected to the inside and outside.
- NAT does not work on a data packet unless a route exists between the outside interface and the inside interface and the data packet meets a certain rule. Therefore, at least one inside interface and one outside interface need to be configured.

▾ **Configuring Inside Address and Port Translation**

- Inside address and port translation is not configured by default.
- Use the **ip nat inside source static { udp | tcp } local-address port global-address port [permit-inside]** command to translate specific inside addresses and ports, so that corresponding services are provided on dedicated ports. For example, TCP port 20 or 21 can be used to construct an FTP server, or TCP port 80 to construct a Web server.

9.3.6 ALG

Common NAT can translate the IP address and port in the header of a UDP or TCP packet, but is helpless before fields in application layer data payloads. In many application layer protocols such as multimedia protocols (H.323 and the like), FTP, and SQLNET, the TCP/UDP payload carries address or port information. If such address or port information cannot be translated by NAT, problems may occur.

Working Principle

The ALG technology can parse application layer packet information and perform address translation for multi-channel protocols, so as to translate or process the IP addresses or ports requiring address translation or some fields requiring special processing, thereby guaranteeing the correctness of application layer communications. All types of ALGs are enabled for NAT by default. Currently the protocols that support ALG include DNS, FTP, H323, PPTP, TFTP, RTSP, and SIP.

Related Configuration

▾ **Enabling or Disabling ALG**

- By default, all ALGs are enabled.
- Use the **no ip nat translation dns** command to disable DNS ALG.

- Use the **no ip nat translation ftp** command to disable FTP ALG.
- Use the **no ip nat translation h323** command to disable H323 ALG.
- Use the **no ip nat translation pptp** command to disable PPTP ALG.
- Use the **no ip nat translation tftp** command to disable TFTP ALG.
- Use the **no ip nat translation rtsp** command to disable RTSP ALG.

9.3.7 Port-Range-based QoS

STAs are divided into several types, which obtain differentiated QoS priorities.

Working Principle

STAs access the wired network via the AP configured with NAT. In the wired links, QoS priorities are expected to be allocated to STAs according to their user types. For an STA, its user type is indicated by the mapped NAT port number of its streams. For example, if the mapped port number falls between 1 and 20000, the STA is recognized as a Level 0 user. If the mapped port number falls between 20001 and 40000, the STA is recognized as a Level 1 user. If the mapped port number falls between 40001 and 60000, the STA is recognized as a Level 2 user.





Related Configuration





▾ Enabling Port-Range-based QoS



- Configure the NAT interface on the intranet and extranet ports on the AP.
- Configure port-range-based QoS on the AP.
- Configure QoS policies on the switches.

9.4 Configuration

| Configuration | Description and Command | |
|--|---|--|
| Configuring Basic NAT |  Mandatory configuration. It is used to configure one-to-one NAT for internal PCs to connect to a WAN. | |
| | ip nat inside | Marks the interface as connected to the inside. |
| | ip nat outside | Marks the interface as connected to the outside. |
| | Optional configuration. It is used to configure static NAT. | |
| | ip nat inside source static <i>local-address</i> <i>global-address</i> [permit-inside] [netmask mask] [match interface] | Defines the static inside source address translation relationship. |
| Optional configuration. It is used to configure dynamic NAT. | | |

| | | |
|--|--|--|
| | <p>ip nat pool <i>address-pool</i> <i>start-address</i> <i>end-address</i> { netmask <i>mask</i> prefix-length <i>prefix-length</i> }</p> <p>or</p> <p>ip nat pool <i>pool-name</i> { netmask <i>netmask</i> prefix-length <i>prefix-length</i> } [type rotary]</p> <p>address <i>start-ip</i> <i>end-ip</i> [match interface <i>interface</i>]</p> | <p>Defines a global IP address pool. For NAT, generally multiple IP addresses are defined. The number of address pools to be defined shall depend on the number of intranet users.</p> |
| | <p>access-list <i>access-list-number</i> permit <i>ip-address</i> <i>wildcard</i></p> | <p>Defines an ACL, so that only the addresses matching this ACL are translated.</p> |
| | <p>ip nat inside source list <i>access-list-number</i> { [pool <i>address-pool</i>] [interface <i>interface-type</i> <i>interface-number</i>] } overload</p> | <p>Defines the dynamic source address translation relationship. The <i>overload</i> parameter may be omitted. It is used only to keep compatibility with mainstream vendors' configuration .</p> |
| <p>Configuring NAT</p> | <p> Mandatory configuration. It is used to configure NAT.</p> | |
| | <p>ip nat inside</p> | <p>Marks the interface as connected to the inside.</p> |
| | <p>ip nat outside</p> | <p>Marks the interface as connected to the outside.</p> |
| | <p> Optional configuration. It is used to configure static NAT.</p> | |
| | <p>ip nat inside source static { UDP <i>local-address</i> <i>port</i> TCP <i>local-address</i> <i>port</i> } <i>global-address</i> <i>port</i> [permit-inside]</p> | <p>Defines the static inside source address translation relationship.</p> |
| <p>Configuring NAT</p> | <p> Optional configuration. It is used to configure dynamic NAT.</p> | |
| | <p>ip nat pool <i>address-pool</i> <i>start-address</i> <i>end-address</i> { netmask <i>mask</i> prefix-length <i>prefix-length</i> }</p> | <p>Defines a global IP address pool. For NAT, generally only one IP address is defined.</p> |
| | <p>access-list <i>access-list-number</i> permit <i>ip-address</i> <i>wildcard</i></p> | <p>Defines an ACL, so that only the addresses matching this ACL are translated.</p> |
| | <p>ip nat inside source list <i>access-list-number</i> { [pool <i>address-pool</i>] [interface <i>interface-type</i> <i>interface-number</i>] } overload</p> | <p>Defines the dynamic source address translation relationship. The <i>overload</i> parameter may be omitted. It is used only to keep compatibility with mainstream vendors' configuration.</p> |
| <p>Configuring Overlapping NAT</p> | <p> Mandatory configuration. It is used to enable overlapping networks to communicate using NAT.</p> | |

| | | |
|--|---|---|
| | ip nat inside | Marks the interface as connected to the inside. |
| | ip nat outside | Marks the interface as connected to the outside.. |
| | ip nat inside source static <i>local-address global-address</i> | Configures inside source address translation. |
| |  Optional configuration. It is used to configure static NAT. | |
| | ip nat outside source static <i>global-address local-address</i> | Configures static NAT. |
| |  Optional configuration. It is used to configure dynamic NAT. | |
| | ip nat pool <i>address-pool start-address end-address { netmask mask prefix-length prefix-length }</i> | Defines a global IP address pool. |
| | access-list <i>access-list-number permit ip-address wildcard</i> | Defines an ACL, so that only the addresses matching this ACL are translated. |
| | ip nat outside source list <i>access-list-number pool address-pool</i> | Defines the dynamic source address translation relationship. The <i>overload</i> parameter may be omitted. It is used only to keep compatibility with mainstream vendors' configuration. |
| Configuring TCP Load Balancing |  Mandatory configuration. It is used to configure destination address polling and translation. | |
| | ip nat inside | Marks the interface as connected to inside. |
| | ip nat outside | Marks the interface as connected to outside. |
| | ip nat pool <i>address-pool start-address end-address { netmask mask prefix-length prefix-length }</i> | Defines an IP address pool, which includes all physical host addresses. |
| | access-list <i>access-list-number permit ip-address wildcard</i> | Defines an ACL, which matches the virtual host address only.  Ensure that the ACL is an extended ACL based on destination IP address matching. |
| | ip nat inside destination list <i>access-list-number pool address-pool [vrf vrf_name]</i> | Defines the dynamic inside destination address translation relationship. |
| Configuring ALG |  Optional configuration. It is used to configure ALG for relevant protocols. | |

| | | |
|--|--|--|
| | ip nat translation { dns [ttl <i>ttl_time</i>] ftp [port <i>port_num</i>] tftp pptp h323 rtsp sip } | Defines ALG for relevant protocols. |
| Configuring Special NAT Applications |  Optional configuration. It is used to configure special NAT applications. | |
| | ip nat application source list <i>list-num</i> destination <i>dest-ip</i> { dest-change <i>ip-addr</i> src-change <i>ip-addr</i> } | Defines rules for special NAT applications. |
| Configuring the Interval at Which NAT Sends Gratuitous ARP Packets |  Optional configuration. It is used to configure the interval at which gratuitous ARP packets are sent from the local address of NAT. | |
| | ip nat keepalive [<i>keepalive_out</i>] | Defines the interval at which gratuitous ARP packets are sent from the local address of NAT. |
| Configuring Port-Range-based QoS | ip nat user-port-range user-type {level0 level1 level2 level3 level4 level5 level6} port-range <i>start-port end-port</i> | Enables QoS priority assignment based on the port range. |

9.4.1 Configuring Basic NAT

Networking Requirements

NAT configuration is required for an intranet to communicate with an extranet by translating an inside private IP address into a globally unique IP address. You can configure static or dynamic NAT or both to implement interconnection and interworking.

Notes

- At least one inside interface and one outside interface need to be configured for basic NAT.
- The newly configured NAT rules take effect on new flows only but not on any existing flows.

Configuration Steps

▾ Configuring the NAT Inside Interface

- Mandatory configuration.
- Configure the LAN interface to connect to the intranet as the NAT inside interface unless otherwise stated.

▾ Configuring the NAT Outside Interface

- Mandatory configuration.
- Configure the WAN interface to connect to the extranet as the NAT outside interface unless otherwise stated.

▾ Configuring Static NAT

- Optional configuration.
- Configure static NAT in global configuration mode when a small number of users in the intranet need to access the extranet.

↳ Configuring Dynamic NAT

- Optional configuration.
- Configure dynamic NAT in global configuration mode when a large number of users in the intranet need to access the extranet.

Verification

N/A

Commands

↳ Configuring the NAT Inside Interface and NAT Outside Interface

| | |
|------------------------------|---|
| Command | ip nat { inside outside } |
| Parameter Description | inside: inside interface outside: outside interface |
| Command Mode | Interface configuration mode |
| Configuration Usage | NAT does not work on a data packet unless a route exists between the outside interface and the inside interface and the data packet meets a certain rule. Therefore, at least one inside interface and one outside interface need to be configured on the router. |

↳ Configuring Static NAT

| | |
|------------------------------|--|
| Command | ip nat inside source static <i>local-address</i> <i>global-address</i> [permit-inside] [netmask <i>mask</i>] [match <i>interface</i>] |
| Parameter Description | <i>local-address:</i> inside address <i>global-address:</i> outside address permit-inside: permits intranet users to access the <i>local-ip</i> host using <i>global-ip</i> . netmask <i>mask:</i> network-segment-to-network-segment address match <i>interface:</i> specifies the egress interface. |
| Command Mode | Global configuration mode |
| Configuration Usage | - |

↳ Configuring the Address Pool

| | |
|------------------------------|--|
| Command | ip nat pool <i>address-pool</i> <i>start-address</i> <i>end-address</i> { netmask <i>mask</i> prefix-length <i>prefix-length</i> } |
| Parameter Description | <i>address-pool:</i> name of the address pool <i>start-address:</i> start IP address <i>end-address:</i> end IP address netmask <i>mask:</i> network mask of the addresses prefix-length <i>prefix-length:</i> length of the network mask of the addresses |
| Command Mode | Global configuration mode |
| Configuration Usage | - |

↳ Configuring Dynamic NAT

| | |
|----------------------------|--|
| Command | ip nat inside source list <i>access-list-number</i> pool <i>address-pool</i> |
| Parameter | <i>access-list-number</i> : ACL number |
| Description | pool <i>address-pool</i> : name of the address pool |
| Command Mode | Global configuration mode |
| Configuration Usage | |

Configuration Example

Enabling Intranet Users to Access an Extranet Server

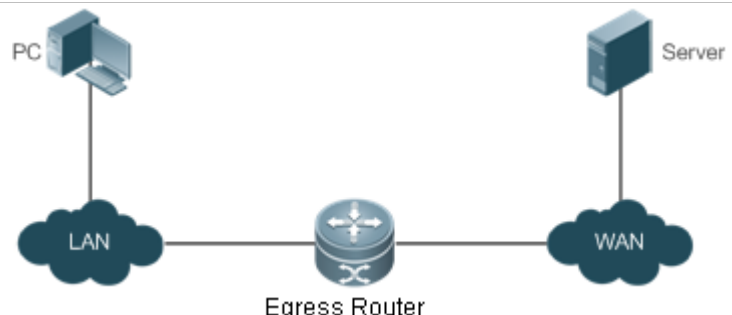
| | |
|---------------------------------------|---|
| <p>Scenario Figure 9-5</p> |  |
| <p>Configuration Steps</p> | <p>Configure ip nat inside on the inside interface.</p> <p>Configure ip nat outside on the outside interface.</p> <p>Configure a dynamic NAT rule.</p> |
| <p>A</p> | <pre>A# configure terminal A(config)# interface GigabitEthernet 0/0 A(config-if-GigabitEthernet 0/0)# ip address 192.168.12.1 255.255.255.0 A(config-if-GigabitEthernet 0/0)# ip nat inside A(config-if-GigabitEthernet 0/0)# exit A(config)# interface GigabitEthernet 0/1 A(config-if-GigabitEthernet 0/1)# ip address 200.168.12.1 255.255.255.0 A(config-if-GigabitEthernet 0/1)# ip nat outside A(config-if-GigabitEthernet 0/1)# exit A(config)# ip nat pool net200 200.168.12.2 200.168.12.100 netmask 255.255.255.0 A(config)# ip nat inside source list 1 pool net200 A(config)# access-list 1 permit 192.168.12.0 0.0.0.255</pre> |
| <p>Verification</p> | <p>Use the show command to display the configuration.</p> |
| <p>A</p> | <pre>Ruijie# show ip nat translations</pre> |

| | Pro | Inside global | Inside local | Outside local | Outside global |
|-----|---------------------|--------------------|-----------------|-----------------|----------------|
| tcp | 200.168.12.200:2063 | 192.168.12.65:2063 | 168.168.12.1:23 | 168.168.12.1:23 | |

Common Errors

- The inside or outside interface is not configured.
- The ACL configuration is incorrect.

9.4.2 Configuring NAT

Networking

Requirements

In general, traditional NAT is one-to-one address mapping, which, however, cannot meet the requirements of all hosts in intranets to communicate with extranets. For example, when the intranet is in short of global IP addresses or even does not apply for global IP addresses but has only one global IP address to connect to an Internet Service Provider (ISP) while a large number of hosts in the intranet need to access the Internet, NAT is required in this scenario.

Multiple inside local addresses can map to one inside global address using NAT.

Notes

- At least one inside interface and one outside interface need to be configured for NAT.
- The newly configured NAT rules take effect on new flows only but not on any existing flows.

Configuration Steps

▾ Configuring the NAT Inside Interface

- Mandatory configuration.
- Configure the LAN interface to connect to the intranet as the NAT inside interface unless otherwise stated.

▾ Configuring the NAT Outside Interface

- Mandatory configuration.
- Configure the WAN interface to connect to the extranet as the NAT outside interface unless otherwise stated.

▾ Configuring Static NAT

- Optional configuration.
- Configure static NAT in global configuration mode when a small number of users in the intranet need to access the extranet.

▾ Configuring Dynamic NAT

- Optional configuration.
- Configure dynamic NAT in global configuration mode when a large number of users in the intranet need to access the extranet.

Verification

N/A

Commands

Configuring the NAT Inside Interface and NAT Outside Interface

| | |
|----------------------------|---|
| Command | ip nat { inside outside } |
| Parameter | inside: inside interface |
| Description | outside: outside interface |
| Command Mode | Interface configuration mode |
| Configuration Usage | NAT does not work on a data packet unless a route exists between the outside interface and the inside interface and the data packet meets a certain rule. Therefore, at least one inside interface and one outside interface need to be configured on the router. |

Configuring Static NAT

| | |
|------------------------------|---|
| Command | ip nat inside source static { udp local-address port tcp local-address port } global-address port [permit-inside] |
| Parameter Description | udp: UDP tcp: TCP <i>local-address:</i> inside local address <i>port:</i> inside local port <i>global-address:</i> outside global address <i>port:</i> outside global port permit-inside: permits intranet users to access the <i>local-ip</i> host using <i>global-ip</i> . |
| Command Mode | Global configuration mode |
| Configuration Usage | This command is used to build an internal server that external public networks can access. Internal hosts are not allowed to access the internal server using the <i>global-address</i> unless permit-inside has been configured. If permit-inside is not configured, internal hosts can access the internal server by using the <i>local-address</i> only. |

Configuring the Address Pool

| | |
|------------------------------|--|
| Command | ip nat pool address-pool start-address end-address { netmask mask prefix-length prefix-length } |
| Parameter Description | <i>address-pool:</i> name of the address pool <i>start-address:</i> start IP address <i>end-address:</i> end IP address netmask mask: network mask of the addresses prefix-length prefix-length: length of the network mask of the addresses |
| Command Mode | Global configuration mode |
| Configuration Usage | - |

Configuring Dynamic NAT

| | |
|----------------|--|
| Command | ip nat inside source list access-list-number { [pool address-pool] [interface interface-type] |
|----------------|--|

| | |
|------------------------------|--|
| | <i>interface-number</i>] } overload |
| Parameter Description | <p><i>access-list-number</i>: ACL number</p> <p>pool <i>address-pool</i>: name of the address pool</p> <p>interface <i>interface-type interface-number</i>: implements NAT using the global address of the outside interface.</p> <p>overload: Indicates that each global address in the address pool can be reused for NAT. Currently, the global addresses are reused even if this parameter is not configured. Therefore, this parameter is used only to keep compatibility with Cisco commands.</p> |
| Command Mode | Global configuration mode |
| Configuration Usage | - |

Configuration Example

▾ Enabling Intranet User to Access an Extranet Server Through NAT

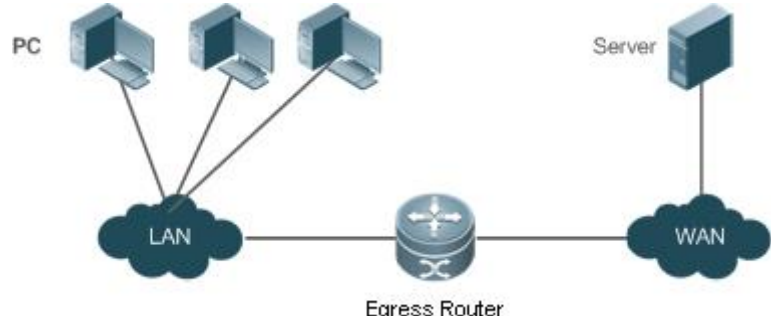
| | |
|---------------------------------------|--|
| <p>Scenario Figure 9-6</p> |  <p>The diagram illustrates a network setup for NAT. On the left, a cloud labeled 'LAN' contains three PC icons. These PCs are connected to a central 'Egress Router' icon. The router is connected to another cloud on the right labeled 'WAN', which contains a 'Server' icon.</p> |
| <p>Configuration Steps</p> | <p>Configure ip nat inside on the inside interface.</p> <p>Configure ip nat outside on the outside interface.</p> <p>Configure a dynamic NAT rule.</p> |
| <p>A</p> | <pre>A# configure terminal A(config)# interface GigabitEthernet 0/0 A(config-if-GigabitEthernet 0/0)# ip address 192.168.12.1 255.255.255.0 A(config-if-GigabitEthernet 0/0)# ip nat inside A(config-if-GigabitEthernet 0/0)# exit A(config)# interface GigabitEthernet 0/1 A(config-if-GigabitEthernet 0/1)# ip address 200.198.12.1 255.255.255.0 A(config-if-GigabitEthernet 0/1)# ip nat outside A(config-if-GigabitEthernet 0/1)# exit A(config)# ip nat pool net200 200.168.12.1 200.168.12.1 netmask 255.255.255.0 A(config)# ip nat inside source list 1 pool net200</pre> |

| | |
|---------------------|--|
| | <pre>A(config)# access-list 1 permit 192.168.12.0 0.0.0.255 A(config)# ip nat inside source static tcp 192.168.12.3 80 200.198.12.1 80</pre> |
| Verification | Use the show command to display the configuration. |
| A | <pre>Ruijie# show ip nat translations Pro Inside global Inside local Outside local Outside global tcp 200.168.12.200:2063 192.168.12.65:2063 168.168.12.1:23 168.168.12.1:23 icmp 200.168.12.200:2064 192.168.12.66:2063 168.168.12.1:23 168.168.12.1:23 udp 200.168.12.200:2065 192.168.12.67:2063 168.168.12.1:23 168.168.12.1:23 tcp 200.168.12.200:2066 192.168.12.68:2063 168.168.12.1:23 168.168.12.1:23 tcp 200.168.12.200:2067 192.168.12.69:2063 168.168.12.1:23 168.168.12.1:23</pre> |

Common Errors

- The inside or outside interface is not configured.
- The ACL configuration is incorrect.

9.4.3 Configuring Overlapping NAT

Networking

Requirements

When the same IP address is allocated to two private networks to interconnect with each other or the same global IP address is allocated to a private network and a public network, this situation is called address overlapping. Two overlapping network hosts cannot communicate, because both hosts consider that the peer host is in the local network. Overlapping NAT is especially designed to implement the communications between two networks with the same IP address. After overlapping NAT is configured, an extranet host address will be represented as another host address in the intranet, and vice versa.

Notes

- Internal source address translation must be configured before overlapping NAT is configured.
- The newly configured NAT rules take effect on new flows only but not on any existing flows.

Configuration Steps

↘ Configuring the NAT Inside Interface

- Mandatory configuration.
- Configure the LAN interface to connect to the intranet as the NAT inside interface unless otherwise stated.

↘ Configuring the NAT Outside Interface

- Mandatory configuration.
- Configure the WAN interface to connect to the extranet as the NAT outside interface unless otherwise stated.

▾ Configuring Static Translation of Outside Source Address

- Optional configuration.
- Configure static translation of outside source address in global configuration mode when a small number of users in the extranet need to access the intranet.

▾ Configuring Dynamic Translation of Outside Source Address

- Optional configuration.
- Configure dynamic translation of outside source address in global configuration mode when a large number of users in the extranet need to access the intranet.

▾ Configuring an ACL

- ACL configuration is mandatory when dynamic source address mapping is used.
- Restrict the range of users requiring source address translation in the intranet.

▾ Configuring a Static Route

- Mandatory configuration.
- Specify the network egress after inside destination address translation.

Verification

N/A

Commands

▾ Configuring the NAT Inside Interface and NAT Outside Interface

| | |
|----------------------------|---|
| Command | ip nat { inside outside } |
| Parameter | inside: inside interface |
| Description | outside: outside interface |
| Command Mode | Interface configuration mode |
| Configuration Usage | NAT does not work on a data packet unless a route exists between the outside interface and the inside interface and the data packet meets a certain rule. Therefore, at least one inside interface and one outside interface need to be configured on the router. |

▾ Configuring Static Translation of Outside Source Address

| | |
|----------------------------|---|
| Command | ip nat outside source static <i>global-address local-address</i> |
| Parameter | <i>global-address:</i> outside global address |
| Description | <i>local-address:</i> inside local address |
| Command Mode | Global configuration mode |
| Configuration Usage | |

▾ Configuring Static Translation of Outside Source Address and Port

| | |
|----------------|---|
| Command | ip nat outside source static { tcp <i>global-address global-port</i> udp <i>global-address global-port</i> } |
|----------------|---|

| | |
|------------------------------|---|
| | <i>local-address local-port</i> |
| Parameter Description | <i>protocol</i> : protocol number <i>global-address</i> : outside global address <i>global-port</i> : outside global port <i>local-address</i> : inside local address <i>local-port</i> : inside local port |
| Command Mode | Global configuration mode |
| Configuration Usage | - |

↘ Configuring the Address Pool

| | |
|------------------------------|---|
| Command | ip nat pool <i>address-pool start-address end-address</i> { netmask <i>mask</i> prefix-length <i>prefix-length</i> } |
| Parameter Description | <i>address-pool</i> : name of the address pool <i>start-address</i> : start IP address <i>end-address</i> : end IP address netmask <i>mask</i> : network mask of the addresses prefix-length <i>prefix-length</i> : length of the network mask of the addresses |
| Command Mode | Global configuration mode |
| Configuration Usage | -- |

↘ Configuring Dynamic Translation of Outside Source Address

| | |
|------------------------------|---|
| Command | ip nat outside source list <i>access-list-number pool pool-name</i> |
| Parameter Description | <i>access-list-number</i> : ACL number pool <i>pool-name</i> : name of the address pool |
| Command Mode | Global configuration mode |
| Configuration Usage | |

Configuration

Example

 The following configuration example describes configuration related to static translation of outside source address.

↘ Static Translation of Outside Source Address

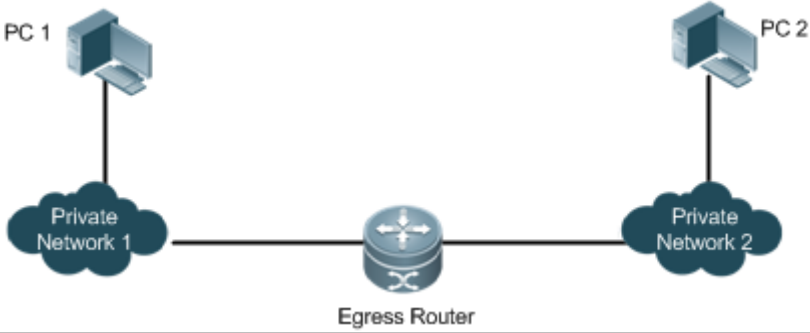
| | |
|--|---|
| <p>Scenario Figure 9-7</p> |  <p>The diagram illustrates a network setup for NAT. On the left, PC 1 is connected to Private Network 1. On the right, PC 2 is connected to Private Network 2. An Egress Router is positioned in the center, connected to both Private Network 1 and Private Network 2, facilitating traffic flow and NAT between the two private networks.</p> |
| <p>Configuration Steps</p> | <p>Configure ip nat inside on the inside interface.</p> <p>Configure ip nat outside on the outside interface.</p> <p>Configure a rule for dynamic translation of inside source address.</p> <p>Configure a rule for static translation of outside source address.</p> |
| <p>A</p> | <pre>A# configure terminal A(config)# interface GigabitEthernet 0/0 A(config-if-GigabitEthernet 0/0)# ip address 192.168.12.1 255.255.255.0 A(config-if-GigabitEthernet 0/0)# ip nat inside A(config-if-GigabitEthernet 0/0)# exit A(config)# interface GigabitEthernet 0/1 A(config-if-GigabitEthernet 0/1)# ip address 200.198.12.1 255.255.255.0 A(config-if-GigabitEthernet 0/1)# ip nat outside A(config-if-GigabitEthernet 0/1)# exit A(config)# ip nat pool net200 200.168.12.2 200.168.12.100 netmask 255.255.255.0 A(config)# ip nat inside source list 1 pool net200 A(config)# access-list 1 permit 192.168.12.0 0.0.0.255 A(config)# ip nat outside source static 192.168.12.3 172.16.10.1 A(config)# ip route 172.16.10.0 255.255.255.0 200.198.12.2</pre> |
| <p>Verification</p> | <p>Use the show command to display the configuration.</p> |
| <p>A</p> | <pre>Ruijie# show ip nat translations Pro Inside global Inside local Outside local Outside global tcp 200.168.12.200:2063 192.168.12.65:2063 172.16.10.1:23 168.168.12.3:23</pre> |

Common Errors

- The inside or outside interface is not configured.
- The ACL configuration is incorrect.

- No static route is configured or no IP address is configured for the outside interface, so that the router does not know to which interface a data packet should be sent after NAT or from which interface a data packet is received after NAT.

9.4.4 Configuring TCP Load Balancing

Networking Requirements

When the TCP traffic load of an intranet host is excessively heavy, multiple hosts can be deployed to implement TCP service load balancing. In this case, NAT can be used to attain this objective. In the following configuration, a virtual host address is defined, so that all TCP connections from extranets to the virtual host are distributed by a router to multiple physical hosts, so as to implement traffic load balancing.

Notes

The newly configured NAT rules take effect on new flows only but not on any existing flows.

Configuration Steps

▾ Configuring the NAT Inside Interface

- Mandatory configuration.
- Configure the LAN interface to connect to the intranet as the NAT inside interface unless otherwise stated.

▾ Configuring the NAT Outside Interface

- Mandatory configuration.
- Configure the WAN interface to connect to the extranet as the NAT outside interface unless otherwise stated.

▾ Configuring Dynamic Translation of Inside Destination Address

- Mandatory configuration.
- Configure dynamic translation of inside destination address in global configuration mode for TCP load balancing.

Verification

N/A

Commands

▾ Configuring the NAT Inside Interface and NAT Outside Interface

| | |
|----------------------------|---|
| Command | <code>ip nat { inside outside }</code> |
| Parameter | inside: inside interface |
| Description | outside: outside interface |
| Command Mode | Interface configuration mode |
| Configuration Usage | NAT does not work on a data packet unless a route exists between the outside interface and the inside interface and the data packet meets a certain rule. Therefore, at least one inside interface and one outside interface need to be configured on the router. |

▾ Configuring the Address Pool

| | |
|------------------------------|--|
| Command | ip nat pool <i>pool-name start-ip end-ip</i> { netmask <i>netmask</i> prefix-length <i>prefix-length</i> } [type rotary] |
| Parameter Description | <i>address-pool</i> : name of the address pool <i>start-address</i> : start IP address <i>end-address</i> : end IP address netmask mask : network mask of the addresses prefix-length prefix-length : length of the network mask of the addresses type rotary : NAT address pool type. Rotary type guarantees equal chance of every address to be assigned. Whether type rotary is configured or not, the NAT address pool type is rotary. This parameter is introduced for compatibility with Cisco. |
| Command Mode | Global configuration mode |
| Configuration Usage | |

▾ **Configuring Dynamic Translation of Inside Destination Address**

| | |
|------------------------------|--|
| Command | ip nat inside destination list <i>access-list-number pool address-pool</i> |
| Parameter Description | <i>access-list-number</i> : ACL number pool pool-name : name of the address pool |
| Command Mode | Global configuration mode |
| Configuration Usage | |

Configuration Example

▾ **Enabling Extranet User to Access an Intranet Server**

| | |
|-------------------------------|---|
| Scenario Figure 9-8 | <p>The diagram illustrates a network topology. On the left, a cloud labeled 'LAN' contains two server icons labeled 'Server 1' and 'Server 2'. A central router icon labeled 'Egress Router' is connected to the LAN cloud. On the right, another cloud labeled 'WAN' contains a PC icon. The Egress Router is also connected to the WAN cloud.</p> |
| Configuration Steps | <p>Configure ip nat inside on the inside interface.</p> <p>Configure ip nat outside on the outside interface.</p> <p>Configure a rule for dynamic inside destination address translation.</p> |
| A | <pre>A# configure terminal A(config)# interface GigabitEthernet 0/0 A(config-if-GigabitEthernet 0/0)# ip address 10.10.10.1 255.255.255.0</pre> |

| | <pre>A(config-if-GigabitEthernet 0/0)# ip nat inside A(config-if-GigabitEthernet 0/0)# exit A(config)# interface GigabitEthernet 0/1 A(config-if-GigabitEthernet 0/1)# ip address 200.198.12.1 255.255.255.0 A(config-if-GigabitEthernet 0/1)# ip nat outside A(config-if-GigabitEthernet 0/1)# exit A(config)# ip nat pool realhosts 10.10.10.2 10.10.10.3 netmask 255.255.255.0 type rotary A(config)# ip nat inside destination list 100 pool realhosts A(config)# access-list 100 permit ip any host 10.10.10.100</pre> | | | | | | | | | | | | | | | |
|---------------------|---|---------------|----------------------|----------------------|---------------|----------------|-----|-----------------|---------------|----------------------|----------------------|-----|-----------------|---------------|----------------------|----------------------|
| Verification | Use the show command to display the configuration. | | | | | | | | | | | | | | | |
| A | <pre>Ruijie# show ip nat translations</pre> <table border="1"> <thead> <tr> <th>Pro</th> <th>Inside global</th> <th>Inside local</th> <th>Outside local</th> <th>Outside global</th> </tr> </thead> <tbody> <tr> <td>tcp</td> <td>10.10.10.100:23</td> <td>10.10.10.2:23</td> <td>100.100.100.100:1178</td> <td>100.100.100.100:1178</td> </tr> <tr> <td>tcp</td> <td>10.10.10.100:23</td> <td>10.10.10.3:23</td> <td>200.200.200.200:1024</td> <td>200.200.200.200:1024</td> </tr> </tbody> </table> | Pro | Inside global | Inside local | Outside local | Outside global | tcp | 10.10.10.100:23 | 10.10.10.2:23 | 100.100.100.100:1178 | 100.100.100.100:1178 | tcp | 10.10.10.100:23 | 10.10.10.3:23 | 200.200.200.200:1024 | 200.200.200.200:1024 |
| Pro | Inside global | Inside local | Outside local | Outside global | | | | | | | | | | | | |
| tcp | 10.10.10.100:23 | 10.10.10.2:23 | 100.100.100.100:1178 | 100.100.100.100:1178 | | | | | | | | | | | | |
| tcp | 10.10.10.100:23 | 10.10.10.3:23 | 200.200.200.200:1024 | 200.200.200.200:1024 | | | | | | | | | | | | |

Common Errors

- The inside or outside interface is not configured.
- The ACL configuration is incorrect. Note that the ACL must be configured as an extended ACL based on destination IP address matching.
- The above configuration takes effect on TCP traffic only but not on other traffic, unless additional NAT configuration has been performed.

9.4.5 Configuring ALG

Networking Requirements

In general, NAT translates only IP address and port information in the header of a packet but does not analyze fields in the application layer data payload of the packet. However, for some special protocols, such as FTP, DNS, and FTTP, the data payloads of their packets may contain IP address or port information. If such information is not translated by NAT, certain problems may occur. The NAT ALG technology can parse application layer packet information and perform address translation for multi-channel protocols, so as to translate or process the IP addresses or ports requiring address translation or some fields requiring special processing, thereby guaranteeing the correctness of application layer communications.

Notes

- At least one inside interface and one outside interface need to be configured during the configuration of ALG.
- The newly configured NAT rules take effect on new flows only but not on any existing flows.

Configuration Steps

↘ Configuring the NAT Inside Interface

- Mandatory configuration.
- Configure the LAN interface to connect to the intranet as the NAT inside interface unless otherwise stated.

↘ Configuring the NAT Outside Interface

- Mandatory configuration.
- Configure the WAN interface to connect to the extranet as the NAT outside interface unless otherwise stated.

↘ Configuring Static NAT

- Optional configuration.
- Configure static NAT in global configuration mode when a small number of users in the intranet need to access the extranet.

↘ Configuring Dynamic NAT

- Optional configuration.
- Configure dynamic NAT in global configuration mode when a large number of users in the intranet need to access the extranet.

↘ Configuring ALG

- Optional configuration.
- The ALG configuration is mandatory if the DNS, FTP, TFTP, PPTP, H323, RTSP, or SIP protocol in the environment needs to implement NAT transversal for communications.

Verification

N/A

Commands

↘ Configuring the NAT Inside Interface and NAT Outside Interface

| | |
|----------------------------|---|
| Command | ip nat { inside outside } |
| Parameter | inside: inside interface |
| Description | outside: outside interface |
| Command Mode | Interface configuration mode |
| Configuration Usage | NAT does not work on a data packet unless a route exists between the outside interface and the inside interface and the data packet meets a certain rule. Therefore, at least one inside interface and one outside interface need to be configured on the router. |

↘ Configuring Static NAT

| | |
|------------------|--|
| Command | ip nat inside source static <i>local-address global-address</i> [permit-inside] [netmask <i>mask</i>] [match <i>interface</i>] |
| Parameter | <i>local-address</i> : inside address |

| | |
|----------------------------|--|
| Description | <i>global-address</i> : outside address permit-inside : permits intranet users to access the <i>local-ip</i> host using <i>global-ip</i> . netmask mask : network-segment-to-network-segment address match interface : specifies the egress interface. |
| Command Mode | Global configuration mode |
| Configuration Usage | - |

↘ Configuring the Address Pool

| | |
|------------------------------|---|
| Command | ip nat pool <i>address-pool</i> <i>start-address</i> <i>end-address</i> { netmask <i>mask</i> prefix-length <i>prefix-length</i> } |
| Parameter Description | <i>address-pool</i> : name of the address pool <i>start-address</i> : start IP address <i>end-address</i> : end IP address netmask mask : network mask of the addresses prefix-length prefix-length : length of the network mask of the addresses |
| Command Mode | Global configuration mode |
| Configuration Usage | |

↘ Configuring Dynamic NAT

| | |
|------------------------------|---|
| Command | ip nat inside source list <i>access-list-number</i> pool <i>address-pool</i> |
| Parameter Description | <i>access-list-number</i> : ACL number pool address-pool : name of the address pool |
| Command Mode | Global configuration mode |
| Configuration Usage | |

↘ Configuring ALG

| | |
|------------------------------|---|
| Command | ip nat translation { dns [ttl <i>tll_time</i>] ftp [port <i>port_num</i>] tftp pptp h323 rtsp sip } |
| Parameter Description | tll : defines the NAT timeout interval of the UDP connection of the DNS application. The default value is 0. <i>port_num</i> : defines the port number used for the FTP application. The default value is 21. |
| Command Mode | Global configuration mode |
| Configuration Usage | |

Configuration Example

↘ Enabling Intranet Users to Access an Extranet Server

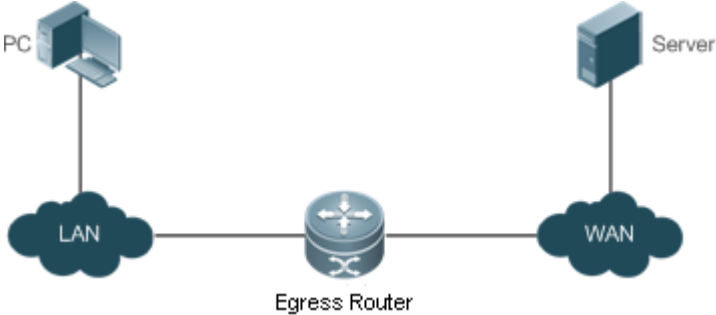
| | |
|--|--|
| <p>Scenario Figure 9-9</p> |  |
| <p>Configuration Steps</p> | <p>Configure ip nat inside on the inside interface.</p> <p>Configure ip nat outside on the outside interface.</p> <p>Configure a dynamic NAT rule.</p> <p>Configure ALG.</p> |
| <p>A</p> | <pre>A# configure terminal A(config)# interface GigabitEthernet 0/0 A(config-if-GigabitEthernet 0/0)# ip address 192.168.12.1 255.255.255.0 A(config-if-GigabitEthernet 0/0)# ip nat inside A(config-if-GigabitEthernet 0/0)# exit A(config)# interface GigabitEthernet 0/1 A(config-if-GigabitEthernet 0/1)# ip address 200.168.12.1 255.255.255.0 A(config-if-GigabitEthernet 0/1)# ip nat outside A(config-if-GigabitEthernet 0/1)# exit A(config)# ip nat pool net200 200.168.12.2 200.168.12.100 netmask 255.255.255.0 A(config)# ip nat inside source list 1 pool net200 A(config)# access-list 1 permit 192.168.12.0 0.0.0.255 A(config)# ip nat translation ftp 23</pre> |
| <p>Verification</p> | <p>Use the show command to display the configuration.</p> |
| <p>A</p> | <pre>Ruijie# show ip nat translations Pro Inside global Inside local Outside local Outside global tcp 200.168.12.200:2063 192.168.12.65:2063 168.168.12.1:23 168.168.12.1:23</pre> |

Common Errors

- The inside or outside interface is not configured.
- The ACL configuration is incorrect.

9.4.6 Configuring Special NAT Applications

Networking Requirements

For some advanced applications of NAT, the source addresses or destination addresses of some specific IP packets need to be modified.

Notes

- At least one inside interface and one outside interface need to be configured for special NAT applications.
- The newly configured NAT rules take effect on new flows only but not on any existing flows.

Configuration Steps

▾ Configuring the NAT Inside Interface

- Mandatory configuration.
- Configure the LAN interface to connect to the intranet as the NAT inside interface unless otherwise stated.

▾ Configuring the NAT Outside Interface

- Mandatory configuration.
- Configure the WAN interface to connect to the extranet as the NAT outside interface unless otherwise stated.

▾ Configuring Static NAT

- Optional configuration.
- Configure static NAT in global configuration mode when a small number of users in the intranet need to access the extranet.

▾ Configuring Dynamic NAT

- Optional configuration.
- Configure dynamic NAT in global configuration mode when a large number of users in the intranet need to access the extranet.

▾ Configuring Special NAT Applications

- Optional configuration.
- This configuration is mandatory if special address translation is required for the communications of some applications.

Verification

N/A

Commands

▾ Configuring the NAT Inside Interface and NAT Outside Interface

| | |
|---------|--|
| Command | <code>ip nat { inside outside }</code> |
|---------|--|

| | |
|----------------------------|---|
| Parameter | inside: inside interface |
| Description | outside: outside interface |
| CommandMode | Interface configuration mode |
| Configuration Usage | NAT does not work on a data packet unless a route exists between the outside interface and the inside interface and the data packet meets a certain rule. Therefore, at least one inside interface and one outside interface need to be configured on the router. |

▾ Configuring Static NAT

| | |
|------------------------------|--|
| Command | ip nat inside source static <i>local-address global-address</i> [permit-inside] [netmask mask] [match interface] |
| Parameter Description | <i>local-address:</i> inside address <i>global-address:</i> outside address permit-inside: permits intranet users to access the <i>local-ip</i> host using <i>global-ip</i> . netmask mask: network-segment-to-network-segment address match interface: specifies the egress interface. |
| Command Mode | Global configuration mode |
| Configuration Usage | - |

▾ Configuring the Address Pool

| | |
|------------------------------|--|
| Command | ip nat pool <i>address-pool start-address end-address</i> { netmask mask prefix-length prefix-length } |
| Parameter Description | <i>address-pool:</i> name of the address pool <i>start-address:</i> start IP address <i>end-address:</i> end IP address netmask mask: network mask of the addresses prefix-length prefix-length: length of the network mask of the addresses |
| Command Mode | Global configuration mode |
| Configuration Usage | |

▾ Configuring Dynamic NAT

| | |
|------------------------------|---|
| Command | ip nat inside source list <i>access-list-number pool address-pool</i> |
| Parameter Description | <i>access-list-number:</i> ACL number pool address-pool: name of the address pool |
| Command Mode | Global configuration mode |
| Configuration Usage | |

▾ Configuring Special NAT Applications

| | |
|----------------|--|
| Command | ip nat application source list <i>list-num destination dest-ip</i> { dest-change ip-addr src-change ip-addr } |
|----------------|--|

| | |
|------------------------------|--|
| Parameter Description | <p><i>local-address</i>: inside address</p> <p><i>global-address</i>: outside address</p> <p>permit-inside: permits intranet users to access the <i>local-ip</i> host using <i>global-ip</i>.</p> <p>netmask mask: network-segment-to-network-segment address</p> <p>match interface: specifies the egress interface.</p> |
| Command Mode | Global configuration mode |
| Configuration Usage | |

Configuration Example

Implementing the DNS Relay Service

| | |
|--------------------------------|---|
| Scenario Figure 9-10 | <p>The diagram illustrates a network topology for NAT. On the left, a PC is connected to a LAN cloud. This LAN cloud is connected to an Egress Router. The Egress Router is also connected to a WAN cloud, which is connected to a Server.</p> |
| Configuration Steps | <p>Configure ip nat inside on the inside interface.</p> <p>Configure ip nat outside on the outside interface.</p> <p>Configure a dynamic NAT rule.</p> <p>Configure special NAT applications.</p> |
| A | <pre> A#configure terminal A(config)# interface GigabitEthernet 0/0 A(config-if-GigabitEthernet 0/0)# ip address 192.168.1.1 255.255.255.0 A(config-if-GigabitEthernet 0/0)# ip nat inside A(config-if-GigabitEthernet 0/0)# exit A(config)# interface GigabitEthernet 0/1 A(config-if-GigabitEthernet 0/1)# ip address 200.168.12.1 255.255.255.0 A(config-if-GigabitEthernet 0/1)# ip nat outside A(config-if-GigabitEthernet 0/1.)# exit A(config)# ip nat pool net200 200.168.12.2 200.168.12.10 netmask 255.255.255.0 A(config)# ip nat inside source list 1 pool net200 A(config)# access-list 1 permit 192.168.12.0 0.0.0.255 </pre> |

| | |
|---------------------|---|
| | <pre>A(config)# ip nat application source list 1 destination udp 192.168.1.1 53 dest-change 202.101.98.55 53 A(config)# access-list 1 permit 192.168.1.0 0.0.0.255</pre> |
| Verification | |

Common Errors

- The inside or outside interface is not configured.

9.4.7 Configuring the Interval at Which NAT Sends Gratuitous ARP Packets

Networking

Requirements

Configure the interval at which gratuitous ARP packets are sent from addresses in the NAT address pool, so as to avoid address conflicts.

Notes

- Sending gratuitous ARP packets is disabled by default on the NAT device.
- Gratuitous ARP packets are sent to the outside interface only.

Configuration Steps

▾ Configuring the NAT Inside Interface

- Mandatory configuration.
- Configure the LAN interface to connect to the intranet as the NAT inside interface unless otherwise stated.

▾ Configuring the NAT Outside Interface

- Mandatory configuration.
- Configure the WAN interface to connect to the extranet as the NAT outside interface unless otherwise stated.

▾ Configuring Static NAT

- Optional configuration.
- Configure static NAT in global configuration mode when a small number of users in the intranet need to access the extranet.

▾ Configuring Dynamic NAT

- Optional configuration.
- Configure dynamic NAT in global configuration mode when a large number of users in the intranet need to access the extranet.

▾ Configuring the Interval at Which NAT Sends Gratuitous ARP Packets

- Optional configuration.

- NAT needs to consider some addresses matching the configured rule as local addresses. This configuration is performed to avoid address conflicts.

Verification

N/A

Commands

▾ Configuring the NAT Inside Interface and NAT Outside Interface

| | |
|----------------------------|---|
| Command | <code>ip nat { inside outside }</code> |
| Parameter | inside: inside interface |
| Description | outside: outside interface |
| Command Mode | Interface configuration mode |
| Configuration Usage | NAT does not work on a data packet unless a route exists between the outside interface and the inside interface and the data packet meets a certain rule. Therefore, at least one inside interface and one outside interface need to be configured on the router. |

▾ Configuring Static NAT

| | |
|----------------------------|--|
| Command | <code>ip nat inside source static <i>local-address</i> <i>global-address</i> [permit-inside] [netmask <i>mask</i>] [match <i>interface</i>]</code> |
| Parameter | <i>local-address</i> : inside address |
| Description | <i>global-address</i> : outside address permit-inside : permits intranet users to access the <i>local-ip</i> host using <i>global-ip</i> . netmask mask : network-segment-to-network-segment address match interface : specifies the egress interface. |
| Command Mode | Global configuration mode |
| Configuration Usage | |

▾ Configuring the Address Pool

| | |
|----------------------------|---|
| Command | <code>ip nat pool <i>address-pool</i> <i>start-address</i> <i>end-address</i> { netmask <i>mask</i> prefix-length <i>prefix-length</i> }</code> |
| Parameter | <i>address-pool</i> : name of the address pool |
| Description | <i>start-address</i> : start IP address <i>end-address</i> : end IP address netmask mask : network mask of the addresses prefix-length prefix-length : length of the network mask of the addresses |
| Command Mode | Global configuration mode |
| Configuration Usage | - |

▾ Configuring Dynamic NAT

| | |
|----------------|---|
| Command | <code>ip nat inside source list <i>access-list-number</i> pool <i>address-pool</i></code> |
|----------------|---|

| | |
|----------------------------|---|
| Parameter | <i>access-list-number</i> : ACL number |
| Description | pool address-pool : name of the address pool |
| Command Mode | Global configuration mode |
| Configuration Usage | - |

↘ **Configuring the Interval at Which NAT Sends Gratuitous ARP Packets**

| | |
|------------------------------|---|
| Command | ip nat keepalive [<i>keepalive_out</i>] |
| Parameter Description | <i>keepalive_out</i> : the interval at which gratuitous ARP packets are sent from the local address of NAT. |
| Command Mode | Global configuration mode |
| Configuration Usage | - |

Configuration Example

↘ **Implementing the Sending of Gratuitous ARP Packets regularly**

| | |
|--------------------------------|---|
| Scenario Figure 9-11 | <p>The diagram illustrates a network topology for NAT configuration. On the left, a PC is connected to a LAN cloud. This LAN cloud is connected to an Egress Router, represented by a central router icon with four arrows pointing outwards. The Egress Router is connected to a WAN cloud, which is in turn connected to a Server on the right.</p> |
| Configuration Steps | <p>Configure ip nat inside on the inside interface.</p> <p>Configure ip nat outside on the outside interface.</p> <p>Configure a dynamic NAT rule.</p> <p>Configure the periodical sending of gratuitous ARP packets.</p> |
| A | <pre>A#configure terminal A(config)# interface GigabitEthernet 0/0 A(config-if-GigabitEthernet 0/0)# ip address 192.168.1.1 255.255.255.0 A(config-if-GigabitEthernet 0/0)# ip nat inside A(config-if-GigabitEthernet 0/0)# exit A(config)# interface GigabitEthernet 0/1 A(config-if-GigabitEthernet 0/1)# ip address 200.168.12.1 255.255.255.0</pre> |

| | |
|---------------------|---|
| | <pre>A(config-if-GigabitEthernet 0/1)# ip nat outside A(config-if-GigabitEthernet 0/1.)# exit A(config)# ip nat pool net200 200.168.12.2 200.168.12.10 netmask 255.255.255.0 A(config)# ip nat inside source list 1 pool net200 A(config)# access-list 1 permit 192.168.12.0 0.0.0.255 A(config)# ip nat keepalive 10</pre> |
| Verification | - |

Common Errors

- The inside or outside interface is not configured.
- NAT rule is not correct.

9.4.8 Configuring Port-Range-based QoS

Networking Requirements

Configure QoS priority assignment based on the mapped port range to apply different QoS policies to streams from users of various types.

Notes

- N/A

Configuration Steps

Configuring Port-Range-based QoS

- Optional configuration.
- Apply user-type-based QoS policies to streams unless otherwise stated.

Commands

Configuring Port-Range-based QoS

| | |
|------------------------------|---|
| Command | ip nat user-port-range user-type {level0 level1 level2 level3 level4 level5 level6} port-range start-port end-port |
| Parameter Description | <p>user-type: user type. Only one port range can be configured for each type. And one user belongs to only one type.</p> <p>level0/level1/level2/level3/level4/level5/level6: specific user type</p> <p>port-range: port range</p> <p><i>start-port:</i> start port number, which ranges from 1 to 65535</p> <p><i>end-port:</i> end port number, which ranges from 1 to 65535</p> |
| Command Mode | Global configuration mode |

| | |
|----------------------|--|
| Configuration | By default, this feature is disabled. |
| Usage | The start port number cannot be smaller than the end port number. Port ranges of user types cannot overlap. |

Verification

- Run the **show ip nat user-port-range{configuration | users | all}** command to check related configuration.

Configuration

Example

▾ **Configuring Port-Range-based QoS**

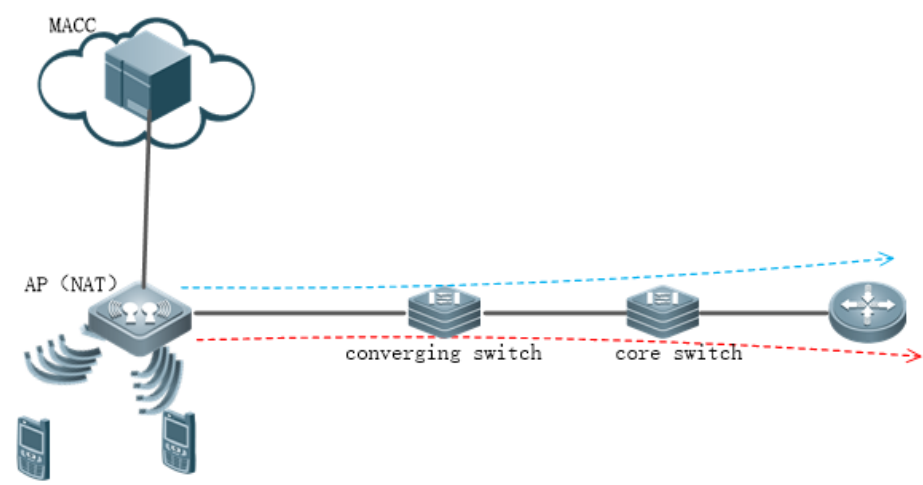
| | |
|--|---|
| <p>Scenario Figure 9-12</p> |  |
| <p>Configuration Steps</p> | <p>Configure QoS priority assignment based on the mapped port range in global configuration mode.</p> |
| <p>A</p> | <pre>Ruijie#configure terminal Ruijie(config)# ap-config ap1 Ruijie(config)# ip nat user-port-range user-type level1 port-range 100 200 Ruijie(config)# ip nat user-port-range user-type level2 port-range 201 300 Ruijie(config)# ip nat user-port-range user-type level3 port-range 401 400 Ruijie(config)# end</pre> |
| <p>Verification</p> | <p>Run the show ip nat user-port-range{configuration users all} command to display related configuration.</p> |
| | <pre>Ruijie# show ip nat user-port-range all User port range NAT configuration: Index User Level Begin Port End Port ----- 1 level0 ---- ---- 2 level1 100 200 3 level2 201 300 4 level3 301 400 5 level4 ---- ----</pre> |

```

6    level5    ----    ----
7    level6    ----    ----

```

User port range NAT users:

```

Index User Level User IP
-----

```

```

1    level11   10.10.10.1
2    level12   10.10.10.2
3    level13   10.10.10.3

```

Common Errors

- N/A

9.5 Monitoring

Displaying

| Function | Command |
|---|---|
| Displays NAT records. | show ip nat translations [<i>dv_id</i>] [<i>slot_id</i>] [<i>acl_num</i>] [icmp tcp udp] [verbose] |
| Displays NAT information based on port range. | show ip nat user-port-range { configuration users all } |



IP Routing Configuration

1. Managing Routes
2. Configuring FPM

1 Managing Routes

1.1 Overview

The network service module (NSM) manages the routing table, consolidates routes sent by various routing protocols, and selects and sends preferred routes to the routing table. Routes discovered by various routing protocols are stored in the routing table. These routes are generally classified by source into three types:

- Direct route: It is the route discovered by a link-layer protocol and is also called interface route.
- Static route: It is manually configured by the network administrator. A static route is easy to configure and less demanding on the system, and therefore applicable to a small-sized network that is stable and has a simple topology. However, when the network topology changes, the static route must be manually reconfigured and cannot automatically adapt to the topological changes.
- Dynamic route: It is the route discovered by a dynamic routing protocol.

1.2 Applications

| Application | Description |
|---|---|
| Basic Functions of the Static Route | Manually configure a route. |
| Floating Static Route | Configure a standby route in the multipath scenario. |
| Load Balancing Static Route | Configure load balancing static routes in the multipath scenario. |

1.2.1 Basic Functions of the Static Route

Scenario

On a network with a simple topology, you can configure only static routes to implement network interworking. Appropriate configuration and use of static routes can improve the network performance and guarantee the bandwidth for important network applications.

As shown in Figure 1-1, to implement interworking between PC 1, PC 2, and PC 3, you can configure static routes on R 1, R 2, and R 3.

- On R 1, configure a route to the network segment of PC 2 through R 2, and a route to the network segment of PC 3 through R 3.
- On R 2, configure a route to the network segment of PC 1 through R 1, and a route to the network segment of PC 3 through R 3.
- On R 3, configure a route to the network segment of PC 1 through R 1, and a route to the network segment of PC 2 through R 2.

Figure 1-1

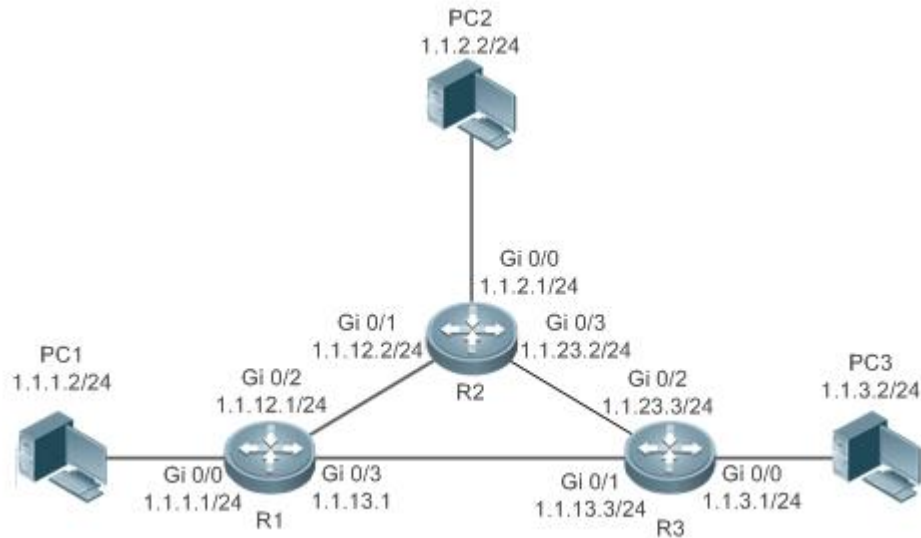

Deployment

- Configure the address and subnet mask of each interface.
- Configure static routes on R 1, R 2, and R 3.

1.2.2 Floating Static Route

Scenario

If no dynamic routing protocol is configured, you can configure floating static routes to implement dynamic switching of routes to prevent communication interruption caused by the network connection failures.

As shown in Figure 1-2, to prevent communication interruption caused by a line failure between R 1 and R 3, you can configure a floating static route respectively on R 1 and R 3. Normally, packets are forwarded on a path with a small administrative distance. If a link on this path is down, the route is automatically switched to the path with a large administrative distance.

- On R1, configure two routes to the network segment of PC 3, including a route through R 3 (default distance = 1) and a route through R 2 (default distance = 2).
- On R 3, configure two routes to the network segment of PC 1, including a route through R 1 (default distance = 1) and a route through R 2 (default distance = 2).

Figure 1-2

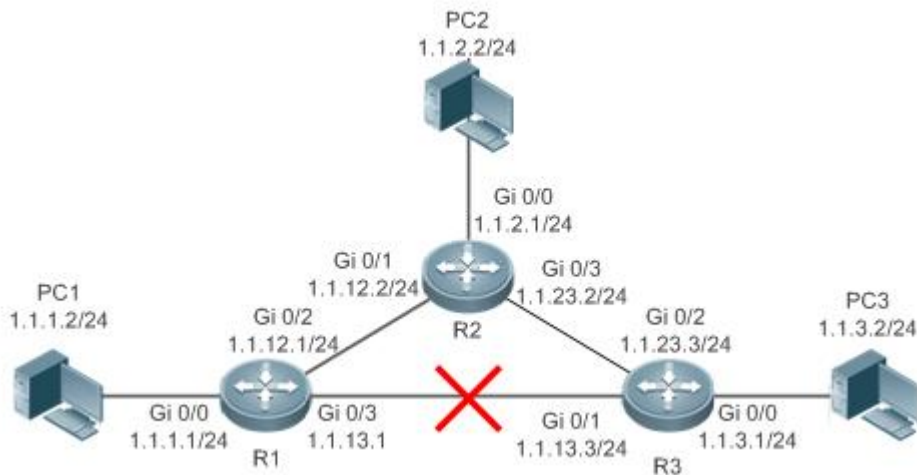

Deployment

- Configure the address and subnet mask of each interface.
- Configure static routes on R 1, R 2, and R 3.

1.2.3 Load Balancing Static Route

Scenario

If there are multiple paths to the same destination, you can configure load balancing routes. Unlike floating routes, the administrative distances of load balancing routes are the same. Packets are distributed among these routes based on the balanced forwarding policy.

As shown in Figure 1-3, load balancing routes are configured respectively on R 1 and R 3 so that packets sent to the network segment of PC 3 or PC 1 are balanced between two routes, including a route through R 2 and a route through R 4.

- On R 1, configure two routes to the network segment of PC 3, including a route through R 2 and a route through R 4.
- On R 3, configure two routes to the network segment of PC 1, including a route through R 2 and a route through R 4.

Figure 1-3



Deployment

- Configure the address and subnet mask of each interface.
- Configure static routes on R 1, R 2, R 3, and R 4.
- Configure the load balancing policy on R 1 and R 3.

1.3 Features

| Feature | Description |
|---|--|
| Route Computation | Generate a valid route on a device. |
| Optimal Route Selection | Select an optimal route to forward packets. |
| Default Route | Forward all packets and help reduce the size of a routing table. |

1.3.1 Route Computation

Routing Function

Routing functions are classified into IPv4 and IPv6 routing functions. If the routing functions are disabled, a device is equivalent to a host and cannot forward routes.

Dynamic Route

A dynamic routing protocol learns remote routes and dynamically updates routes by exchanging routes with neighbors. If a neighbor is the next hop of a route and this neighbor fails, the route fails as well.

Static Route

On a network with a simple topology, you can configure only static routes to implement network interworking. Appropriate configuration and use of static routes can improve the network performance and guarantee the bandwidth for important network applications.

Whether a static route is active is computed based on the status of the local interface. When the exit interface of a static route is located at layer 3 (L3) and is in Up status (the link status is Up and the IP address is configured), this route is active and can be used for packet forwarding.

1.3.2 Optimal Route Selection

Administrative Distance

When multiple routing protocols generate routes to the same destination, the priorities of these routes can be determined based on the administrative distance. A smaller administrative distance indicates a higher priority.

Equal-Cost Route

If multiple routes to the same destination have different next hops but the same administrative distance, these routes are mutually equal-cost routes. Packets are distributed among these routes to implement load balancing based on the balanced forwarding policy.

On a specific device, the total number of equal-cost routes is limited. Routes beyond the limit do not participate in packet forwarding.

Floating Route

If multiple routes to the same destination have different next hops and different administrative distances, these routes are mutually floating routes. The route with the smallest administrative distance will be first selected for packet forwarding. If this route fails, a route with a larger administrative distance is further selected for forwarding, thus preventing communication interruption caused by a network line failure.

1.3.3 Default Route

In the forwarding routing table, the route with the destination network segment 0.0.0.0 and the subnet mask 0.0.0.0 is the default route. Packets that cannot be forwarded by other routes will be forwarded by the default route. The default route can be statically configured or generated by a dynamic routing protocol.



Static Default Route

On a L3 device, a static route with the network segment 0.0.0.0 and the subnet mask 0.0.0.0 is configured to generate the default route.

Default Network

The default network is configured to generate a default route. If the **ip default-network** command is configured to specify a network (a classful network, such as a Class A, B, or C network), and this network exists in the routing table, the router will use this network as the default network and the next hop of this network is the default gateway. As the network specified by the **ip default-network** command is a classful one, if this command is used to identify a subnet in a classful network, the router automatically generates a static route of the classful network instead of any default route.

1.4 Configuration

| Configuration Item | Description and Command | |
|---|---|--|
| Configuring a Static Route |  (Mandatory) It is used to configure a static route entry. | |
| | ip route | Configures an IPv4 static route. |
| | ipv6 route | Configures an IPv6 static route. |
| Configuring a Default Route |  (Optional) It is used to configure the default gateway. | |
| | ip default gateway | Configures an IPv4 default gateway on a L2 device. |
| | ipv6 default gateway | Configures an IPv6 default gateway on a L2 device. |
| | ip route 0.0.0.0 0.0.0.0 gateway | Configures an IPv4 default gateway on a L3 device. |
| | ipv6 route ::/0 ipv6-gateway | Configures an IPv6 default gateway on a L3 device. |
| | ip default network | Configures an IPv4 default network on a L3 device. |
| Configuring Route Limitations |  (Optional) It is used to limit the number of equal-cost routes and number of static routes, or disable routing. | |
| | maximum-paths | Configures the maximum number of equal-cost routes. |
| | ip static route-limit | Configures the maximum number of IPv4 static routes. |
| | ipv6 static route-limit | Configures the maximum number of IPv6 static routes. |
| | no ip routing | Disables IPv4 routing. |
| | noipv6 unicast-routing | Disables IPv6 routing. |

1.4.1 Configuring a Static Route

Configuration Effect

- Generate a static route in the routing table. Use the static route to forward packets to a remote network.

Notes

- If the **no ip routing** command is configured on a L3 switch, you cannot configure IPv4 static routes on this switch, and existing IPv4 static routes will also be deleted. Before the device is restarted, reconfiguring the **ip routing** command can recover the deleted IPv4 static routes. After the device is restarted, deleted IPv4 static routes cannot be recovered.

- If the **no ipv6 unicast-routing** command is configured on a L3 switch, you cannot configure IPv6 static routes on this switch, and existing IPv6 static routes will also be deleted. Before the device is restarted, reconfiguring the **ipv6 unicast-routing** command can recover the deleted IPv6 static routes. After the device is restarted, deleted IPv6 static routes cannot be recovered.

Configuration Steps

↳ Configuring a Static IPv4 Route

Configure the following command on an IPv4-enabled router.

| | | |
|------------------------------|---|--|
| Command | ip route <i>network</i> net-mask { <i>ip-address</i> <i>interface</i> [<i>ip-address</i>] } [<i>distance</i>] [tag <i>tag</i>] [permanent [weight <i>number</i>]] [description <i>description-text</i>] [disabled enabled] [global] | |
| Parameter Description | <i>network</i> | Indicates the address of the destination network. |
| | <i>net-mask</i> | Indicates the mask of the destination network. |
| | <i>ip-address</i> | (Optional) Indicates the next-hop address of the static route. You must specify at least one of <i>ip-address</i> and <i>interface</i> , or both of them. If <i>ip-address</i> is not specified, a static direct route is configured. |
| | <i>interface</i> | (Optional) Indicates the next-hop exit interface of the static route. You must specify at least one of <i>ip-address</i> and <i>interface</i> , or both of them. If <i>interface</i> is not specified, a recursive static direct route is configured. The exit interface is obtained by the next hop in the routing table. |
| | <i>distance</i> | (Optional) Indicates the administrative distance of the static route. The administrative distance is 1 by default. |
| | <i>tag</i> | (Optional) Indicates the tag of the static route. The tag is 0 by default. |
| | permanent | (Optional) Indicates the flag of the permanent route. The static route is not a permanent route by default. |
| | weight <i>number</i> | (Optional) Indicates the weight of the static route. The weight is 1 by default. |
| | description <i>description-text</i> | (Optional) Indicates the description of the static route. By default, no description is configured. <i>description-text</i> is a string of one to 60 characters. |
| | disabled/enabled | (Optional) Indicates the enable flag of the static route. The flag is enabled by default. |
| global | (Optional) Indicates that the next hop belongs to a global VRF. By default, the VRF of the next hop is the same as the VRF specified by <i>vrf name</i> . | |
| Defaults | By default, no static route is configured. | |
| Command Mode | Global configuration mode | |
| Usage Guide | The simplest configuration of this command is ip route <i>network</i> net-mask <i>ip-address</i> . | |

↳ Configuring an IPv6 Static Route

Configure the following command on an IPv6-enabled router.

| | |
|----------------|--|
| Command | ipv6 route <i>ipv6-prefix/prefix-length</i> { <i>ipv6-address</i> <i>interface</i> [<i>ipv6-address</i>] } [<i>distance</i>] [weight <i>number</i>] [description <i>description-text</i>] |
|----------------|--|

| | | |
|------------------------------|--|--|
| Parameter Description | <i>ipv6-prefix</i> | Indicates the IPv6 prefix, which must comply with the address expression specified in RFC4291. |
| | <i>prefix-length</i> | Indicates the length of the IPv6 prefix. Note that a slash (/) must be added in front of the length. |
| | <i>ipv6-address</i> | (Optional) Indicates the next-hop address of the static route. You must specify at least one of <i>ipv6-address</i> and <i>interface</i> , or both of them. If <i>ipv6-address</i> is not specified, a static direct route is configured. |
| | <i>interface</i> | (Optional) Indicates the next-hop exit interface of the static route. You must specify at least one of <i>ipv6-address</i> and <i>interface</i> , or both of them. If <i>interface</i> is not specified, a recursive static direct route is configured. The exit interface is obtained by the next hop in the routing table. |
| | <i>distance</i> | (Optional) Indicates the administrative distance of the static route. The administrative distance is 1 by default. |
| | weight number | (Optional) Indicates the weight of the static route, which must be specified when you configure equal-cost routes. The weight ranges from 1 to 8. When the weights of all equal-cost routes of a route are summed up, the sum cannot exceed the maximum number of equal-cost routes that can be configured for the route. Weighting of equal-cost routes of a route indicates the traffic ratio of these routes. The weight is 1 by default. |
| | description <i>description-text</i> | (Optional) Indicates the description of the static route. By default, no description is configured. <i>description-text</i> is a string of one to 60 characters. |
| Defaults | By default, no static route is configured. | |
| Command Mode | Global configuration mode | |
| Usage Guide | The simplest configuration of this command is ipv6 route <i>ipv6-prefix / prefix-lengthipv6-address</i> . | |

Verification

- Run the **show ip route** command to display the IPv4 routing table and check whether the configured IPv4 static route takes effect.
- Run the **show ipv6 route** command to display the IPv6 routing table and check whether the configured IPv6 static route takes effect.

Configuration Example

📄 Configuring Static Routes to Implement Interworking of the IPv4 Network

| | |
|--|---|
| <p>Scenario Figure 1-4</p> | |
| <p>Configuration Steps</p> | <ul style="list-style-type: none"> Configure interface addresses on each device. |
| <p>R1</p> | <pre>R1#configure terminal R1(config)#interface gigabitEthernet 0/0 R1(config-if-GigabitEthernet 0/0)# ip address 1.1.1.1 255.255.255.0 R1(config-if-GigabitEthernet 0/0)# exit R1(config)#interface gigabitEthernet 0/2 R1(config-if-GigabitEthernet 0/2)# ip address 1.1.12.1 255.255.255.0 R1(config-if-GigabitEthernet 0/0)# exit R1(config)#interface gigabitEthernet 0/3 R1(config-if-GigabitEthernet 0/3)# ip address 1.1.13.1 255.255.255.0</pre> |
| <p>R2</p> | <pre>R2#configure terminal R2(config)#interface gigabitEthernet 0/0 R2(config-if-GigabitEthernet 0/0)# ip address 1.1.2.1 255.255.255.0 R2(config-if-GigabitEthernet 0/0)# exit R2(config)#interface gigabitEthernet 0/1 R2(config-if-GigabitEthernet 0/1)# ip address 1.1.12.2 255.255.255.0 R2(config-if-GigabitEthernet 0/0)# exit R2(config)#interface gigabitEthernet 0/3 R2(config-if-GigabitEthernet 0/3)# ip address 1.1.23.2 255.255.255.0</pre> |
| <p>R3</p> | <pre>R3#configure terminal R3(config)#interface gigabitEthernet 0/0</pre> |

| | |
|---------------------|--|
| | <pre>R3(config-if-GigabitEthernet 0/0)# ip address 1.1.3.1 255.255.255.0 R3(config-if-GigabitEthernet 0/0)# exit R3(config)#interface gigabitEthernet 0/1 R3(config-if-GigabitEthernet 0/1)# ip address 1.1.13.3 255.255.255.0 R3(config-if-GigabitEthernet 0/0)# exit R3(config)#interface gigabitEthernet 0/2 R3(config-if-GigabitEthernet 0/2)# ip address 1.1.23.3 255.255.255.0</pre> |
| | <ul style="list-style-type: none"> ● Configure static routes on each device. |
| R1 | <pre>R1#configure terminal R1(config)#ip route 1.1.2.0 255.255.255.0 GigabitEthernet 0/2 1.1.12.2 R1(config)# ip route 1.1.3.0 255.255.255.0 GigabitEthernet 0/3 1.1.13.3</pre> |
| R2 | <pre>R2#configure terminal R2(config)#ip route 1.1.1.0 255.255.255.0 GigabitEthernet 0/1 1.1.12.1 R2(config)# ip route 1.1.3.0 255.255.255.0 GigabitEthernet 0/3 1.1.23.3</pre> |
| R3 | <pre>R3#configure terminal R3(config)#ip route 1.1.2.0 255.255.255.0 GigabitEthernet 0/2 1.1.23.2 R3(config)# ip route 1.1.1.0 255.255.255.0 GigabitEthernet 0/1 1.1.13.1</pre> |
| | |
| Verification | <ul style="list-style-type: none"> ● Display the routing table. |
| R1 | <pre>R1# show ip route Codes: C - Connected, L - Local, S - Static R - RIP, O - OSPF, B - BGP, I - IS-IS N1 - OSPF NSSA external type 1, N2 - OSPF NSSA external type 2 E1 - OSPF external type 1, E2 - OSPF external type 2 SU - IS-IS summary, L1 - IS-IS level-1, L2 - IS-IS level-2 IA - Inter area, * - candidate default Gateway of last resort is no set C 1.1.1.0/24 is directly connected, GigabitEthernet 0/0 C 1.1.1.1/32 is local host. S 1.1.2.0/24 [1/0] via 1.1.12.2, GigabitEthernet 0/2</pre> |

| | |
|------------------|---|
| | <pre> S 1.1.3.0/24 [1/0] via 1.1.13.3, GigabitEthernet 0/2 C 1.1.12.0/24 is directly connected, GigabitEthernet 0/2 C 1.1.12.1/32 is local host. C 1.1.13.0/24 is directly connected, GigabitEthernet 0/3 C 1.1.13.1/32 is local host. </pre> |
| <p>R2</p> | <pre> R2# show ip route Codes: C - Connected, L - Local, S - Static R - RIP, O - OSPF, B - BGP, I - IS-IS N1 - OSPF NSSA external type 1, N2 - OSPF NSSA external type 2 E1 - OSPF external type 1, E2 - OSPF external type 2 SU - IS-IS summary, L1 - IS-IS level-1, L2 - IS-IS level-2 IA - Inter area, * - candidate default Gateway of last resort is no set S 1.1.1.0/24 [1/0] via 1.1.12.1, GigabitEthernet 0/0 C 1.1.2.0/24 is directly connected, GigabitEthernet 0/0 C 1.1.2.1/32 is local host. S 1.1.3.0/24 [1/0] via 1.1.23.3, GigabitEthernet 0/3 C 1.1.12.0/24 is directly connected, GigabitEthernet 0/1 C 1.1.12.2/32 is local host. C 1.1.23.0/24 is directly connected, GigabitEthernet 0/3 C 1.1.23.2/32 is local host. </pre> |
| <p>R3</p> | <pre> R3# show ip route Codes: C - Connected, L - Local, S - Static R - RIP, O - OSPF, B - BGP, I - IS-IS N1 - OSPF NSSA external type 1, N2 - OSPF NSSA external type 2 E1 - OSPF external type 1, E2 - OSPF external type 2 SU - IS-IS summary, L1 - IS-IS level-1, L2 - IS-IS level-2 IA - Inter area, * - candidate default Gateway of last resort is no set </pre> |

| |
|---|
| <p>S 1.1.1.0/24 [1/0] via 1.1.13.1, GigabitEthernet 0/2</p> <p>S 1.1.2.0/24 [1/0] via 1.1.23.2, GigabitEthernet 0/2</p> <p>C 1.1.3.0/24 is directly connected, GigabitEthernet 0/0</p> <p>C 1.1.3.1/32 is local host.</p> <p>C 1.1.13.0/24 is directly connected, GigabitEthernet 0/1</p> <p>C 1.1.13.3/32 is local host.</p> <p>C 1.1.23.0/24 is directly connected, GigabitEthernet 0/2</p> <p>C 1.1.23.3/32 is local host.</p> |
|---|

📌 **Configuring Static Routes to Implement Interworking of the IPv6 Network**

| | |
|---------------------------------------|--|
| <p>Scenario Figure 1-5</p> | |
| <p>Configuration Steps</p> | <ul style="list-style-type: none"> Configure interface addresses on each device. |
| <p>R1</p> | <pre>R1#configure terminal R1(config)#interface gigabitEthernet 0/0 R1(config-if-GigabitEthernet 0/0)# ipv6 address 1111:1111::1/64 R1(config-if-GigabitEthernet 0/0)# exit R1(config)#interface gigabitEthernet 0/1 R1(config-if-GigabitEthernet 0/1)# ipv6 address 1111:1212::1/64</pre> |
| <p>R2</p> | <pre>R2#configure terminal R2(config)#interface gigabitEthernet 0/0 R2(config-if-GigabitEthernet 0/0)#ipv6 address 1111:2323::1/64 R2(config-if-GigabitEthernet 0/0)# exit R2(config)#interface gigabitEthernet 0/1 R2(config-if-GigabitEthernet 0/1)# ipv6 address 1111:1212::2/64</pre> |
| <p>R1</p> | <ul style="list-style-type: none"> Configure static routes on each device. <pre>R1#configure terminal</pre> |

| | |
|---------------------|--|
| | R1(config)# ipv6 route 1111:2323::0/64 gigabitEthernet 0/1 |
| R2 | R2#configure terminal R2(config)#ipv6 route 1111:1111::0/64 gigabitEthernet 0/1 |
| Verification | <ul style="list-style-type: none"> ● Display the routing table. |
| R1 | <pre>R1# show ipv6 route IPv6 routing table name - Default - 10 entries Codes: C - Connected, L - Local, S - Static R - RIP, O - OSPF, B - BGP, I - IS-IS N1 - OSPF NSSA external type 1, N2 - OSPF NSSA external type 2 E1 - OSPF external type 1, E2 - OSPF external type 2 SU - IS-IS summary, L1 - IS-IS level-1, L2 - IS-IS level-2 IA - Inter area C 1111:1111::/64 via GigabitEthernet 0/0, directly connected L 1111:1111::1/128 via GigabitEthernet 0/0, local host C 1111:1212::/64 via GigabitEthernet 0/1, directly connected L 1111:1212::1/128 via GigabitEthernet 0/1, local host S 1111:2323::/64 [1/0] via GigabitEthernet 0/1, directly connected C FE80::/10 via ::1, Null0 C FE80::/64 via GigabitEthernet 0/0, directly connected L FE80::2D0:F8FF:FEFB:C092/128 via GigabitEthernet 0/0, local host C FE80::/64 via GigabitEthernet 0/1, directly connected L FE80::2D0:F8FF:FEFB:C092/128 via GigabitEthernet 0/1, local host</pre> |
| R2 | <pre>R2# show ipv6 route IPv6 routing table name - Default - 10 entries Codes: C - Connected, L - Local, S - Static R - RIP, O - OSPF, B - BGP, I - IS-IS N1 - OSPF NSSA external type 1, N2 - OSPF NSSA external type 2</pre> |

| | |
|---|--|
| | <p>E1 - OSPF external type 1, E2 - OSPF external type 2</p> <p>SU - IS-IS summary, L1 - IS-IS level-1, L2 - IS-IS level-2</p> <p>IA - Inter area</p> |
| C | 1111:2323::/64 via GigabitEthernet 0/0, directly connected |
| L | 1111:2323::1/128 via GigabitEthernet 0/0, local host |
| C | 1111:1212::/64 via GigabitEthernet 0/1, directly connected |
| L | 1111:1212::1/128 via GigabitEthernet 0/1, local host |
| S | 1111:1111::/64 [1/0] via GigabitEthernet 0/1, directly connected |
| C | FE80::/10 via ::1, Null0 |
| C | FE80::/64 via GigabitEthernet 0/0, directly connected |
| L | FE80::2D0:F8FF:FEFB:C092/128 via GigabitEthernet 0/0, local host |
| C | FE80::/64 via GigabitEthernet 0/1, directly connected |
| L | FE80::2D0:F8FF:FEFB:C092/128 via GigabitEthernet 0/1, local host |

Common Errors

- The link on the interface is not up.
- No IP address is configured for the interface.

1.4.2 Configuring a Default Route

Configuration Effect

- Generate a default route in the routing table. The default route is used to forward packets that cannot be forwarded by other routes.

Notes

- On a L3 switch, run the **ip route 0.0.0.0 0.0.0.0 gateway** or **ipv6 route ::/0 ipv6-gateway** command to configure the default gateway.

Configuration Steps

Configuring the IPv4 Default Gateway on a L3 Switch

| | | |
|--------------------|--|--|
| Command | ip route 0.0.0.0 0.0.0.0 { <i>ip-address</i> <i>interface</i> [<i>ip-address</i>]} [<i>distance</i>] [tag <i>tag</i>] [permanent] [weight <i>number</i>] [description <i>description-text</i>] [disabled enabled] [global] | |
| Parameter | 0.0.0.0 | Indicates the address of the destination network. |
| Description | 0.0.0.0 | Indicates the mask of the destination network. |
| | <i>ip-address</i> | (Optional) Indicates the next-hop address of the static route. You must specify at least |

| | | |
|---------------------|---|--|
| | | one of <i>ip-address</i> and <i>interface</i> , or both of them. If <i>ip-address</i> is not specified, a static direct route is configured. |
| | <i>interface</i> | (Optional) Indicates the next-hop exit interface of the static route. You must specify at least one of <i>ip-address</i> and <i>interface</i> , or both of them. If <i>interface</i> is not specified, a recursive static direct route is configured. The exit interface is obtained by the next hop in the routing table. |
| | <i>distance</i> | (Optional) Indicates the administrative distance of the static route. The administrative distance is 1 by default. |
| | <i>tag</i> | (Optional) Indicates the tag of the static route. The tag is 0 by default. |
| | permanent | (Optional) Indicates the flag of the permanent route. The static route is not a permanent route by default. |
| | weight number | (Optional) Indicates the weight of the static route. The weight is 1 by default. |
| | description <i>description-text</i> | (Optional) Indicates the description of the static route. By default, no description is configured. <i>description-text</i> is a string of one to 60 characters. |
| | disabled /enabled | (Optional) Indicates the enable flag of the static route. The flag is enabled by default. |
| | global | (Optional) Indicates that the next hop belongs to a global VRF. By default, the VRF of the next hop is the same as the VRF specified by <i>vrf name</i> . |
| Defaults | By default, no static default route is configured. | |
| Command Mode | Global configuration mode | |
| Usage Guide | The simplest configuration of this command is ip route0.0.0.0 0.0.0.0 ip-address . | |

▾ **Configuring the IPv6 Default Gateway on a L3 Switch**

| | | |
|------------------------------|---|--|
| Command | ipv6 route::<i>0</i> { <i>ipv6-address</i> <i>interface</i> [<i>ipv6-address</i>] } [<i>distance</i>] [weight<i>number</i>] [description<i>description-text</i>] | |
| Parameter Description | :: | Indicates the IPv6 prefix, which must comply with the address expression specified in RFC4291. |
| | 0 | Indicates the length of the IPv6 prefix. Note that a slash (/) must be added in front of the length. |
| | <i>ipv6-address</i> | (Optional) Indicates the next-hop address of the static route. You must specify at least one of <i>ipv6-address</i> and <i>interface</i> , or both of them. If <i>ipv6-address</i> is not specified, a static direct route is configured. |
| | <i>interface</i> | (Optional) Indicates the next-hop exit interface of the static route. You must specify at least one of <i>ipv6-address</i> and <i>interface</i> , or both of them. If <i>interface</i> is not specified, a recursive static direct route is configured. The exit interface is obtained by the next hop in the routing table. |
| | <i>distance</i> | (Optional) Indicates the administrative distance of the static route. The administrative distance is 1 by default. |
| | weight number | (Optional) Indicates the weight of the static route, which must be specified when you configure equal-cost routes. The weight ranges from 1 to 8. When the weights of all equal-cost routes of a route are summed up, the sum cannot exceed the maximum |

| | | |
|---------------------|---|--|
| | | number of equal-cost routes that can be configured for the route. Weighting of equal-cost routes of a route indicates the traffic ratio of these routes. The weight is 1 by default. |
| | description <i>description-text</i> | (Optional) Indicates the description of the static route. By default, no description is configured. <i>description-text</i> is a string of one to 60 characters. |
| Defaults | By default, no static default route is configured. | |
| Command Mode | Global configuration mode | |
| Usage Guide | The simplest configuration of this command is ipv6 route ::/0 ipv6-gateway . | |

📌 **Configuring the IPv4 Default Network on a L3 Switch**

| | | |
|------------------------------|---|---|
| Command | ip default-network <i>network</i> | |
| Parameter Description | <i>network</i> | Indicates the address of the network. (The network must be a Class A, B, or C network.) |
| Defaults | By default, no default network is configured. | |
| Command Mode | Global configuration mode | |
| Usage Guide | If the network specified by the ip default-network command exists, a default route is generated and the next hop to this network is the default gateway. If the network specified by the ip default-network command does not exist, the default route is not generated. | |

Verification

- On a L3 switch where routing is enabled, run the **show ip route** or **show ipv6 route** command to display the default route.

Configuration Example

📌 **Configuring IPv4 Default Routes on L3 Devices to Implement Network Interworking**

| | |
|-------------------------------|---|
| Scenario Figure 1-6 | |
| Configuration Steps | <ul style="list-style-type: none"> ● Configure IP addresses on L3 devices. |
| R1 | <pre>R1#configure terminal R1(config)#interface gigabitEthernet 0/0 R1(config-if-GigabitEthernet 0/0)# ip address 1.1.1.1 255.255.255.0</pre> |

| | |
|---------------------|---|
| | <pre>R1(config-if-GigabitEthernet 0/0)# exit R1(config)#interface gigabitEthernet 0/1 R1(config-if-GigabitEthernet 0/1)# ip address 1.1.12.1 255.255.255.0 R1(config-if-GigabitEthernet 0/0)# exit</pre> |
| R2 | <pre>R2#configure terminal R2(config)#interface gigabitEthernet 0/0 R2(config-if-GigabitEthernet 0/0)# ip address 1.1.2.1 255.255.255.0 R2(config-if-GigabitEthernet 0/0)# exit R2(config)#interface gigabitEthernet 0/1 R2(config-if-GigabitEthernet 0/1)# ip address 1.1.12.2 255.255.255.0 R2(config-if-GigabitEthernet 0/0)# exit</pre> |
| R1 | <ul style="list-style-type: none"> ● Configure an IPv6 default gateway on R 1. <pre>R1#configure terminal R1(config)#ip route 0.0.0.0 0.0.0.0 GigabitEthernet 0/1 1.1.12.2</pre> |
| R2 | <pre>R2#configure terminal R2(config)#ip route 0.0.0.0 0.0.0.0 GigabitEthernet 0/1 1.1.12.1</pre> |
| | |
| Verification | <ul style="list-style-type: none"> ● Display the routing table. |
| R1 | <pre>R1# show ip route Codes: C - Connected, L - Local, S - Static R - RIP, O - OSPF, B - BGP, I - IS-IS N1 - OSPF NSSA external type 1, N2 - OSPF NSSA external type 2 E1 - OSPF external type 1, E2 - OSPF external type 2 SU - IS-IS summary, L1 - IS-IS level-1, L2 - IS-IS level-2 IA - Inter area, * - candidate default Gateway of last resort is 1.1.12.2 S* 0.0.0.0/0 [1/0] via 1.1.12.2, GigabitEthernet 0/1 C 1.1.1.0/24 is directly connected, GigabitEthernet 0/0 C 1.1.1.1/32 is local host. C 1.1.12.0/24 is directly connected, GigabitEthernet 0/1</pre> |

```
C 1.1.12.1/32 is local host.
```

1.4.3 Configuring Route Limitations

Configuration Effect

- Limit the number of equal-cost routes and number of static routes, or disable routing.

Notes

N/A

Configuration Steps

↘ Configuring the Maximum Number of Equal-Cost Routes

| | | |
|---------------------|--|---|
| Command | maximum-paths <i>number</i> | |
| Parameter | <i>number</i> | Indicates the maximum number of equal-cost routes. The value ranges from 1 to 64. |
| Description | | |
| Defaults | The default value varies from products. | |
| Command Mode | Global configuration mode | |
| Usage Guide | Run this command to configure the maximum number of next hops in the equal-cost route. In load balancing mode, the number of routes on which traffic is balanced does not exceed the configured number of equal-cost routes. | |

↘ Configuring the Maximum Number of IPv4 Static Routes

| | | |
|---------------------|--|---|
| Command | ip static route-limit <i>number</i> | |
| Parameter | <i>number</i> | Indicates the upper limit of routes. The value ranges from 1 to 10,000. |
| Description | | |
| Defaults | By default, a maximum of 1,024 IP static routes can be configured. | |
| Command Mode | Global configuration mode | |
| Usage Guide | Run this command to configure the maximum number of IPv4 static routes. If the maximum number of IPv4 static routes is reached, no more IPv4 static route can be configured. | |

↘ Configuring the Maximum Number of IPv6 Static Routes

| | | |
|---------------------|--|---|
| Command | ipv6 static route-limit <i>number</i> | |
| Parameter | <i>number</i> | Indicates the upper limit of routes. The value ranges from 1 to 10,000. |
| Description | | |
| Defaults | By default, a maximum of 1,000 IPv6 static routes can be configured. | |
| Command Mode | Global configuration mode | |

| | |
|--------------------|--|
| Usage Guide | Run this command to configure the maximum number of IPv6 static routes. If the maximum number of IPv6 static routes is reached, no more IPv6 static route can be configured. |
|--------------------|--|

↘ Disabling IPv4 Routing

| | |
|------------------------------|---|
| Command | no ip routing |
| Parameter Description | N/A |
| Defaults | By default, IPv4 routing is enabled. |
| Command Mode | Global configuration mode |
| Usage Guide | Run this command to disable IPv6 routing. If the device functions only as a bridge or a voice over IP (VoIP) gateway, the device does not need to use the IPv4 routing function of the RGOS software. In this case, you can disable the IPv4 routing function of the RGOS software. |

↘ Disabling IPv6 Routing

| | |
|------------------------------|---|
| Command | no ipv6 unicast-routing |
| Parameter Description | N/A |
| Defaults | By default, IPv6 routing is enabled. |
| Command Mode | Global configuration mode |
| Usage Guide | Run this command to disable IPv6 routing. If the device functions only as a bridge or a VoIP gateway, the device does not need to use the IPv6 routing function of the RGOS software. In this case, you can disable the IPv6 routing function of the RGOS software. |

Verification

Run the **show run** command to display the configuration file and verify that the preceding configuration commands exist.

Configuration Example

↘ Configuring at Most Two Static Routing Limitations

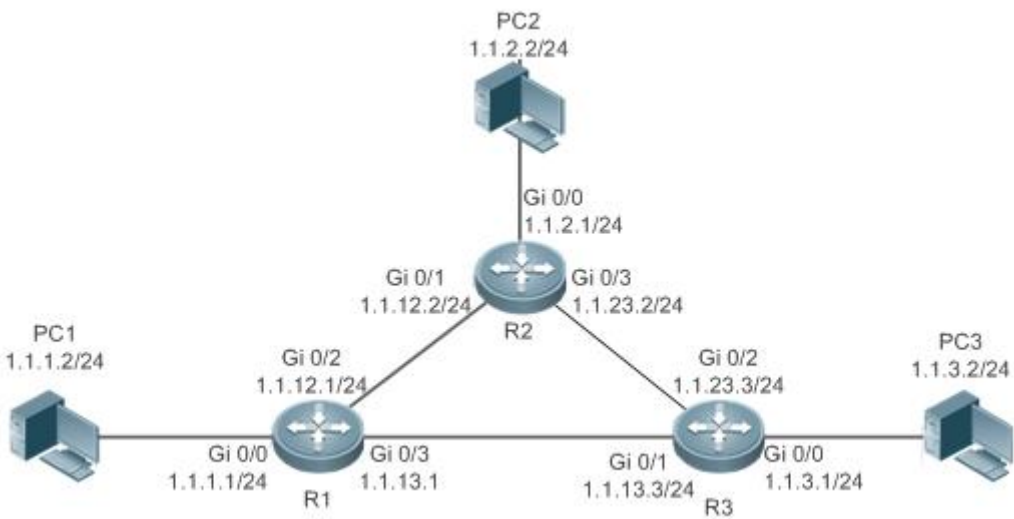
| | |
|---------------------------------------|--|
| <p>Scenario Figure 1-7</p> |  |
| <p>Configuration Steps</p> | <p>On R 1, configure the IP addresses, static routes, and maximum number of static routes.</p> |
| | <pre> R1#configure terminal R1(config)#interface gigabitEthernet 0/0 R1(config-if-GigabitEthernet 0/0)# ip address 1.1.1.1 255.255.255.0 R1(config-if-GigabitEthernet 0/0)# exit R1(config)#interface gigabitEthernet 0/2 R1(config-if-GigabitEthernet 0/2)# ip address 1.1.12.1 255.255.255.0 R1(config-if-GigabitEthernet 0/0)# exit R1(config)#interface gigabitEthernet 0/3 R1(config-if-GigabitEthernet 0/3)# ip address 1.1.13.1 255.255.255.0 R1(config-if-GigabitEthernet 0/3)# exit R1(config)#ip route 1.1.3.0 255.255.255.0 1.1.13.3 R1(config)#ip route 1.1.4.0 255.255.255.0 1.1.12.2 R1(config)#ip route 1.1.5.0 255.255.255.0 1.1.12.2 R1(config)#ip static route-limit 2 % Exceeding maximum static routes limit. </pre> |
| <p>Verification</p> | <ul style="list-style-type: none"> ● Check the static routes that really take effect in the routing table. |
| | <pre> R1(config)# show ip route </pre> |

```

Codes: C - Connected, L - Local, S - Static
       R - RIP, O - OSPF, B - BGP, I - IS-IS
       N1 - OSPF NSSA external type 1, N2 - OSPF NSSA external type 2
       E1 - OSPF external type 1, E2 - OSPF external type 2
       SU - IS-IS summary, L1 - IS-IS level-1, L2 - IS-IS level-2
       IA - Inter area, * - candidate default

Gateway of last resort is no set

C    1.1.1.0/24 is directly connected, GigabitEthernet 0/0
C    1.1.1.1/32 is local host.
S    1.1.3.0/24 [1/0] via 1.1.13.3
S    1.1.4.0/24 [1/0] via 1.1.12.2
C    1.1.12.0/24 is directly connected, GigabitEthernet 0/2
C    1.1.12.1/32 is local host.
C    1.1.13.0/24 is directly connected, GigabitEthernet 0/3
C    1.1.13.1/32 is local host.
    
```

1.5 Monitoring

Displaying

| Description | Command |
|----------------------------------|-----------------------|
| Displays the IPv4 routing table. | show ip route |
| Displays the IPv6 routing table. | show ipv6route |

Debugging

 System resources are occupied when debugging information is output. Therefore, disable debugging immediately after use.

| Description | Command |
|---|---|
| Debugs IPv4 route management. | debug nsm kernel ucast-v4 |
| Debugs IPv6 route management. | debug nsm kernel ucast-v6 |
| Debugs default network management. | debug nsm kernel default-network |
| Debugs internal events of route management. | debug nsm events |

| | |
|---|------------------------------|
| Debugs sending of route management and routing protocol messages. | debug nsm packet send |
| Debugs receiving of route management and routing protocol messages. | debug nsm packet recv |

2 Configuring FPM

2.1 Overview

The flow platform (FPM) is a platform for the acceleration of packet service processing. Because IP packets have the flow attribute, the FPM provides services with the function to identify the flow attribute of IP packets before service processing, so as to improve service processing efficiency. The FPM is a fundamental platform. It is loaded upon system startup. The configuration commands described in this document are provided to implement FPM configuration and management. In general, the default configuration of the FPM can already meet practical requirements.

 The following sections describe the FPM only.

Protocols and Standards

N/A

2.2 Applications

| Application | Description |
|--|---|
| Configuring the packet receiving threshold | A standalone device serves as the gateway to forward packets. |
| Configuring loose TCP status check | Perform active/standby switchover in the AS environment. |

2.2.1 Configuring the Packet Receiving Threshold

Scenario

When the device receives a large number of repeated TCP connection requests in a local area network (LAN), no legitimate connection can be established if the device cannot receive any handshake response packet from the peer. In this case, attacks probably occur. You can perform FPM configuration to restrict the number of TCP connection requests, so as to effectively defend against such attacks.

Protocols

- Enable the strict packet status tracing function on the forwarding device.
- Configure a low TCP-SYN-SENT packet threshold.

2.2.2 Configuring Loose TCP Status Check

Scenario

Loose TCP status check should be configured on the device to prevent flow interruption during active/standby switchover of the device. Then a connection can be established and packets can be forwarded as long as one end sends an ACK packet, so that the connection is not interrupted at all during the active/standby switchover.

Protocols

- Configure loose TCP status check on the backup device.

2.3 Features

Basic Concepts

↳ Flow Entry

A flow entry, as a physical resource for the device to identify and manage all connections of an IP session, records basic information about the current IP session. The corresponding protocols include ICMP, TCP, UDP, and RAWIP.

Overview

| Feature | Description |
|--|---|
| Transparent transmission when the flow table is full | This feature ensures that the existing flows are not interrupted when the flow table is full. |
| Flow entry aging | This feature reclaims invalid flow entries. |
| Number of packets permitted in a flow | This feature prevents IP packet flooding attacks. |
| TCP status tracing | This feature filters out packets on illegitimate TCP connections. |
| Strict packet status tracing | This feature performs packet threshold check. |
| Loose TCP status check | This feature allows the establishment of a connection with only ACK packets. |

2.3.1 Transparent Transmission of Packets When the Flow Table Is Full

Working Principle

The acceleration of IP service processing relies on a flow table. Flow table resources are configured according to the current product hardware configuration and generally can meet application requirements in an application environment. In some extreme environments, however, flow table resources could be exhausted, causing the failure to establish flows. With this

feature, packets are transparently transmitted instead of establishing any flow on wireless products when the flow table is full, and service processing is not accelerated, thereby ensuring that service flows are not interrupted.

2.3.2 Flow Entry Aging

Working Principle

The aging of a flow entry means that the device actively withdraws the flow entry when there is no data exchange in a certain period of time. If a session attack occurs, the flow table will be full, causing the failure to establish sessions. The aging of the flow table is designed to solve this problem. For flow entries of different data types, their aging time shall be set according to actual service requirements. For flows of different service data types, different aging time shall be set according to different states of the flows. For example, the aging time of a TCP flow in SYN status is different from that of a TCP flow in ESTABLISH status. For example again, when a port scanning attack occurs on a network, abundant flow table resources of the system are occupied, and then appropriate aging time can be configured for flows established on these connections according to the states of the flows, so as to effectively reclaim flow entries and avoid flow interruption. Configuring appropriate aging time can help to reduce "useless" flow entries in the flow table while meeting the requirement for exchanging service data flows.

2.3.3 Number of Packets Permitted in a Flow

Working Principle

For each flow in the current status, there is a counter that records the number of packets processed in the flow. An attacker may send a large number of packets of a certain type to wage a traffic attack, in which case other types of packets cannot be processed in time. You can configure the number of packets permitted to pass in a flow in a certain status, so as to solve this problem and meet the requirement for exchanging service data flows.

2.3.4 TCP Status Tracing

Working Principle

A complete handshake process is required for the establishment of a TCP connection; otherwise, the connection is illegitimate or the packets are attack packets. The FPM needs to trace the states of TCP connections, so as to distinguish flows that are established over TCP session connections in various states and determine whether the connections are legitimate. In some special scenarios such as asymmetrical routing, however, the states of TCP connections cannot be traced and then this function should be disabled.

2.3.5 Packet Threshold for Flows in Various States

Working Principle

For a flow in a certain status established over a connection, there is an upper limit on the number of packets permitted on the legitimate connection. If this upper limit is exceeded, a packet flooding attack probably occurs, occupying the forwarding resources of the system. Therefore, you can configure a packet threshold for flows in various states so as to effectively defend against such attacks.

2.3.6 Loose TCP Status Check

Working Principle

A complete handshake process is required for the establishment of a legitimate TCP connection. In some cases such as active/standby switchover, however, probably a handshake process has been performed for the current TCP connection but only no corresponding information exists. In such cases, the system requires only ACK packets. For this purpose, the FPM provides loose TCP status check.

2.4 Configuration

| Configuration | Description and Command | |
|--------------------------------------|--|--|
| Configuring the Functions of the FPM |  (Optional) It is used to manage FPM. | |
| | ip session direct-trans-disable | Disables the function to transparently transmit packets when the flow table is full. |
| | ip session timeout | Configures the flow entry aging time. |
| | ip session threshold | Configures the number of packets that can be received for each flow in a certain status. |
| | ip session tcp_state-inspection-enable | Enables the TCP status tracing function. |
| | ip session track-state-strictly | Configures packet threshold for flows in various states. |
| | ip session tcp-loose | Enables the loose TCP status transition check function. |

2.4.1 Disabling Transparent Transmission of Packets When the Flow Table Is Full

Networking Requirements

- For some special services such as network address translation (NAT) applied on wireless products, the FPM should not allow the transparent transmission of packets without flow establishment.

Notes

- Currently this function is available on wireless products only.
- By default, packets can be transparently transmitted without flow establishment when the flow table is full.

Configuration Steps

- Optional configuration.
- By default, packets can be transparently transmitted without flow establishment when the flow table is full. You can use the **ip session direct-trans-disable** command to disable the function.

| | |
|------------------------------|--|
| Command | ip session direct-trans-disable |
| Parameter Description | |
| Defaults | Packets can be transparently transmitted without flow establishment when the flow table is full. |
| Command Mode | Global configuration mode |
| Usage Guide | Use the no form of this command to enable the transparent transmission function. |

Verification

- Use the **show run** command to check whether the configuration includes **ip session direct-trans-disable**. If no, the transparent transmission function is enabled.

Configuration Example

| | |
|----------------------------|--|
| Scenario | If the NAT service is required on the current wireless device, you need to disable the transparent transmission function because the NAT service does not allow the transparent transmission of IP packets without flow establishment. |
| Configuration Steps | Disable transparent transmission of packets without flow establishment when the flow table is full. |
| | <pre>Ruijie# configure terminal Ruijie(config)# ip session direct-trans-disable</pre> |
| Verification | Use the show run command to verify that the configuration includes ip session direct-trans-disable . |

Common Errors

N/A

2.4.2 Configuring the Flow Entry Aging Time

Networking Requirements

- Reasonably make use of system flow table resources so as to reduce "useless" flow entries in the flow table and meet the requirement for exchanging service data flows.

Notes

- There is a default aging time upon system initialization, which can meet practical requirements in most scenarios. Therefore, the configuration is optional.
- Because a certain time is required before the system detects the corresponding flow, the actual aging time is slightly later than the configured aging time.

Configuration Steps

▾ Configuring the Aging Time

- Optional configuration.
- By default, a flow entry ages within the default aging time. If the default aging time does not meet the requirement, you can use the **ip session timeout** command to change it. The longer the aging time, the longer the time-to-live (TTL) of the flow entry.
- Perform this configuration on the corresponding forwarding device.

| | |
|------------------------------|---|
| Command | ip session timeout {icmp-closed icmp-connected icmp-started rawip-closed rawip-connected rawip-established rawip-started tcp-close-wait tcp-closed tcp-established tcp-fin-wait1 tcp-fin-wait2 tcp-syn-receive tcp-syn-sent tcp-syn-sent2 tcp-time-wait udp-closed udp-started udp-connected udp-established} { num } |
| Parameter Description | <p>icmp-closed: Sets the aging time of ICMP flows in closed status, which is 10 seconds by default and ranges from 5 to 60.</p> <p>icmp-connected: Sets the aging time of ICMP flows in connected status, which is 10 seconds by default and ranges from 5 to 120.</p> <p>icmp-started: Sets the aging time of ICMP flows in started status, which is 10 seconds by default and ranges from 5 to 120.</p> <p>rawip-closed: Sets the aging time of RAWIP flows in closed status, which is 10 seconds by default and ranges from 5 to 60.</p> <p>rawip-connected: Sets the aging time of RAWIP flows in connected status, which is 300 seconds by default and ranges from 10 to 300.</p> <p>rawip-established: Sets the aging time of RAWIP flows in established status, which is 300 seconds by default and ranges from 10 to 600.</p> <p>rawip-started: Sets the aging time of RAWIP flows in started status, which is 300 seconds by default and ranges from 10 to 300.</p> <p>tcp-close-wait: Sets the aging time of TCP flows in tcp-close-wait status, which is 60 seconds by default and ranges from 10 to 120.</p> <p>tcp-closed: Sets the aging time of TCP flows in tcp-closed status, which is 10 seconds by default and ranges from 5 to 20.</p> |

| | |
|---------------------|---|
| | <p>tcp-established: Sets the aging time of TCP flows in tcp-established status, which is 1,800 seconds by default and ranges from 300 to 604,800.</p> <p>tcp-fin-wait1: Sets the aging time of TCP flows in tcp-fin-wait1status, which is 60 seconds by default and ranges from 10 to 120.</p> <p>tcp-fin-wait2: Sets the aging time of TCP flows in tcp-fin-wait2status, which is 60 seconds by default and ranges from 10 to 120.</p> <p>tcp-syn-sent: Sets the aging time of TCP flows in tcp-syn-sent status, which is 10 seconds by default and ranges from 5 to 30.</p> <p>tcp-syn_sent2: Sets the aging time of TCP flows in tcp-syn_sent2 status, which is 10 seconds by default and ranges from 5 to 30.</p> <p>tcp-syn-receive: Sets the aging time of TCP flows in tcp-syn-receive status, which is 10 seconds by default and ranges from 5 to 30.</p> <p>tcp-time-wait: Sets the aging time of TCP flows in tcp-time-wait status, which is 10 seconds by default and ranges from 5 to 60.</p> <p>udp-closed: Sets the aging time of UDP flows in closed status, which is 10 seconds by default and ranges from 5 to 60.</p> <p>udp-connected: Sets the aging time of UDP flows in connected status, which is 30 seconds by default and ranges from 10 to 300.</p> <p>udp-established: Sets the aging time of UDP flows in established status, which is 600 seconds by default and ranges from 120 to 600.</p> <p>udp-started: Sets the aging time of UDP flows in started status, which is 10 seconds by default and ranges from 10 to 300.</p> <p>num: Sets the aging time</p> |
| Defaults | Default values apply. |
| Command Mode | Global configuration mode |
| Usage Guide | Use the no form of the commands to restore the default aging time. |

Verification

- Use the **show run** command to check whether the configuration includes **ip session timeout**. If no, the default aging time applies.

Configuration Example

| | |
|----------------------------|---|
| Scenario | If there are a large number of UDP-established flows which occupy a great space of the flow table on the current forwarding device, you can shorten the aging time of the UDP-established flows to improve aging efficiency. |
| Configuration Steps | Set the aging time of flows in udp-established status to 120 seconds. |
| | <pre>Ruijie# configure terminal Ruijie(config)# ip session 1 2 timeout udp-established 120</pre> |
| Verification | <p>The aging time should be 120 seconds.</p> <p>Use the show run command to verify that the configuration contains the following item:</p> <pre>ip session 1 2 timeout udp-established 120</pre> <p>This indicates that the aging time is 120 seconds.</p> |

Common Errors

-

2.4.3 Configuring the Number of Packets Permitted in a Flow

Networking Requirements

- An attacker may send a large number of packets of a certain type to wage a traffic attack, in which case other types of packets cannot be processed in time. You can configure the number of packets permitted in a flow in a certain status, so as to solve this problem and meet the requirement for exchanging service data flows.

Notes

- There is a default packet count upon system initialization, which can meet practical requirements in most scenarios. Therefore, the configuration is optional.
- The check function here is disabled by default. To enable the check function, you need to configure packet threshold check for flows in various states first.

Configuration Steps

- Optional configuration.
- By default, a flow is judged according to the default number of packets permitted to pass in the flow. If the default number of packets permitted to pass does not meet the requirement, you can use the **ip session threshold** command to change the number of packets allowed to pass in the corresponding flow. The greater the value, the more packets permitted to pass in the flow.
- Perform this configuration on each forwarding device as necessary.

| | |
|----------------|---|
| Command | ip session threshold {icmp-closed icmp-started rawip-closed tcp-syn-sent tcp-syn-receive |
|----------------|---|

| | |
|------------------------------|--|
| | tcp-closed udp-closed } { <i>num</i> } |
| Parameter Description | <p>icmp-closed: Sets the number of packets permitted to pass in each ICMP flow in closed status, which is 10 by default and ranges from 1 to 2,000,000,000.</p> <p>icmp-started: Sets the number of packets permitted to pass in each ICMP flow in started status, which is 300 by default and ranges from 5 to 2,000,000,000.</p> <p>rawip-closed: Sets the number of packets permitted to pass in each RAWIP flow in closed status, which is 10 by default and ranges from 1 to 2,000,000,000.</p> <p>tcp-syn-sent: Sets the number of packets permitted to pass in each TCP flow in syn-send status, which is 10 by default and ranges from 10 to 2,000,000,000.</p> <p>tcp-syn-receive: Sets the number of packets permitted to pass in each TCP flow in syn-receive status, which is 20 by default and ranges from 5 to 2,000,000,000.</p> <p>tcp-closed: Sets the number of packets permitted to pass in each TCP flow in closed status, which is 20 by default and ranges from 5 to 2,000,000,000.</p> <p>udp-closed: Sets the number of packets permitted to pass in each UDP flow in closed status, which is 10 by default and ranges from 1 to 2,000,000,000.</p> <p><i>num:</i> Sets the number of packets permitted to pass</p> |
| Command Mode | Global configuration mode |
| Usage Guide | Use the no form of the command to restore the default number of packets permitted to pass. |

Verification

- Use the **show run** command to check whether the configuration includes **ip session threshold**. If no, the default values about the number of packets permitted to pass apply.

Configuration Example

| | |
|----------------------------|---|
| Scenario | When a large number of ping packets exist on a network, a flooding attack probably occurs. You can configure the number of packets permitted to pass in each ICMP flow in icmp-started status, so as to deny such ping packets. |
| Configuration Steps | Set the number of packets permitted to pass in each ICMP flow in icmp-started status to 10. |
| | <pre>Ruijie# configure terminal Ruijie(config)# ip session 1 2 threshold icmp-started 10</pre> |
| Verification | <p>The number should be 10.</p> <p>Use the show run command to verify that the configuration contains the following item:</p> <pre>ip session 1 2 threshold icmp-started 10</pre> |

| | |
|--|---|
| | This indicates that the number of packets permitted to pass in each ICMP flow in icmp-started status is 10. |
|--|---|

Common Errors

-

2.4.4 Enabling the TCP Status Tracing Function

Networking Requirements

- Perform this configuration to enable the TCP status tracing function.

Notes

- The TCP status tracing function is disabled by default.

Configuration Steps

- Optional configuration.
- The TCP status tracing function is disabled by default. You can use the **ip session [dev] [slot] tcp-state-inspection-enable** command to enable the TCP status tracing function.

| | |
|------------------------------|---|
| Command | ip session tcp-state-inspection-enable |
| Parameter Description | |
| Defaults | The TCP status tracing function is disabled. |
| Command Mode | Global configuration mode |
| Usage Guide | Use the no form of this command to restore the TCP status tracing function to default. |

Verification

- Use the **show run** command to check whether the configuration includes **ip session tcp-state-inspection-disable**. If no, the TCP status tracing function is enabled.

Configuration Example

| | |
|----------------------------|---|
| Scenario | The current forwarding device is a FW card located in slot 2 of device 1. If the FW card is located on an asymmetrical routing path in the current forwarding environment, you need to disable the TCP status tracing function. |
| Configuration Steps | Disable the TCP status tracing function on the forwarding device in slot 2 of device 1. |
| | Ruijie# configure terminal |

| | |
|---------------------|--|
| | Ruijie(config)# ip session 1 2 tcp-state-inspection-disable |
| Verification | Use the show run command to verify that the configuration includes ip session tcp-state-inspection-disable . |

Common Errors

-

2.4.5 Configuring Packet Threshold Check for Flows in Various States

Networking Requirements

- Perform this configuration to enable the packet threshold check function and disable the current flow when packets are unreachable.

Notes

-

Configuration Steps

- Optional configuration.
- You can use the **ip session track-state-strictly** command to enable the strict packet status tracing function.
- The packet threshold check function needs to be enabled in a scenario such as the scenario where attacks are waged using a certain type of packet.

| | |
|------------------------------|--|
| Command | ip session track-state-strictly |
| Parameter Description | |
| Defaults | The strict packet status tracing function is disabled. |
| Command Mode | Global configuration mode |
| Usage Guide | Use the no form of this command to restore the default configuration. |

Verification

- Use the **show run** command to check whether the configuration includes **ip session track-state-strictly**. If no, the strict packet status tracing function is disabled.

Configuration Example

| | |
|----------------------------|--|
| Scenario | If ICMP flooding attacks occur in the current network environment, packet threshold check is needed. In this case, perform this configuration to enable the packet threshold check function. |
| Configuration Steps | Enable the strict packet status tracing function on the forwarding device. |
| | <pre>Ruijie# configure terminal Ruijie(config)# ip session 1 2 track-state-strictly</pre> |
| Verification | Use the show run command to verify that the configuration includes ip session track-state-strictly . |

Common Errors

-

2.4.6 Configuring Loose TCP Status Check

Networking Requirements

- A flow can be directly established with only ACK packets.

Notes

- By default, the establishment of a flow with an ACK packet is allowed on FW products.
- This configuration is optional.

Configuration Steps

- Optional configuration.
- By default, the loose TCP status check function is disabled on FW products. You can use the **ip session tcp-loose** command to enable the loose TCP status check function. By default, the loose TCP status check function is enabled on all wireless and EG products.
- The loose TCP status check function is required on the standby device in a scenario such as active/standby switchover.

| | |
|------------------------------|--|
| Command | ip session tcp-loose |
| Parameter Description | |
| Command Mode | Global configuration mode |
| Usage Guide | Use the no form of this command to restore the default configuration. |

Verification

- Use the **show run** command to check whether the configuration includes **ip session tcp-loose**. If no, the loose TCP status check function is disabled.

Configuration Example

| | |
|----------------------------|--|
| Scenario | Active/standby switchover is required in the current environment. Perform this configuration on the backup device. |
| Configuration Steps | Enable the loose TCP status check function. |
| | <pre>Ruijie# configure terminal Ruijie(config)# ip session 1 2 tcp-loose</pre> |
| Verification | Use the show run command to verify that the configuration includes ip session tcp-loose . |

Common Errors

-

2.5 Monitoring

Clearing

- i** If you run the **clear** command while the device is operating, services may be interrupted arising from the loss of important information.

| Function | Command |
|---|--------------------------------|
| Clears counters about the IPv4 packets. | clear ip fpm counters |
| Clears counters about the IPv6 packets. | clear ip v6fpm counters |

Displaying

| Function | Command |
|----------|---------|
|----------|---------|

| | |
|---|-----------------------------------|
| Displays the counters about the IPv4 packets | show ip fpm counters |
| Displays the counters about the IPv6 packets | show ip v6fpm counters |
| Displays IPv4 packet flow information | show ip fpm flows |
| Displays IPv4 packet flow information except specific IPv4 packet flows | show ip fpm flows filter |
| Displays IPv6 packet flow information | show ip v6fpm flows |
| Displays IPv6 packet flow information except specific IPv6 packet flows | show ip v6fpm flows filter |
| Displays IPv4 flow statistics | show ip fpm statistics |
| Displays IPv6 flow statistics | show ip v6fpm statistics |



Security Configuration

1. Configuring Web Authentication
2. Configuring AAA
3. Configuring RADIUS
4. Configuring 802.1X
5. Configuring ARP Check
6. Configuring Gateway-targeted ARP Spoofing Prevention
7. Configuring Global IP-MAC Binding
8. Configuring DHCP Snooping
9. Configuring IP Source Guard
10. Configuring DNS Snooping
11. Configuring IGMP Snooping
12. Configuring the ACL
13. Configuring SCC

14. Configuring SSH

1 Configuring Web Authentication

1.1. Overview

1.1.1. Web Authentication





Web authentication controls user access to networks. It requires no authentication software on clients. Instead, users can perform authentication on common browsers.

When unauthenticated clients attempt to access the Internet using browsers, the network access server (NAS) forcibly redirects the browsers to a specified site pointing to a Web authentication server, also called a portal server. Users can access the services on the portal server before being authenticated, such as downloading security patches and reading notices. If a user wants to access network resources beyond the portal server, the user must get authenticated by the portal server through a browser.

Besides providing convenient authentication, the portal server performs Webpage interaction with browsers, providing personalized services, such as advertisements, notices, and business links on the authentication page.

Ruijie Web Authentication Versions

There are three versions of Ruijie Web authentication, including Ruijie First-Generation Web Authentication, Ruijie Second-Generation Web Authentication, and Ruijie Internal Portal (iPortal) Web Authentication. The Web authentication process varies with authentication versions. For details, see Section 1.3 "Features".

-  The three versions of Web authentication are highly divergent in features and configurations. It is recommended to read through the relevant chapters carefully before configuration.
-  Both Ruijie Second-Generation Web Authentication and Ruijie iPortal Web Authentication support local account authentication on the NAS. Because Remote Authentication Dial In User Service (RADIUS) authentication is more commonly used in reality, it is used as an example in the chapter "Applications".
-  The concept of "interface" varies with product types. For example, the interfaces on a layer-2 switch are physical ports; the interfaces on a router may be sub interfaces; the interfaces on wireless devices may represent a wireless local area network (WLAN). This document uses the unified term "interface" to include them. In application, recognize the real meaning based on specific products and functions.
-  Web authentication supports user online traffic detection. For details, see the Configuring SCC.
-  Web authentication supports the authentication of domain names. That is, accounts can be authenticated in the format of user name@domain name. This requires enabling the domain-name-based authentication, authorization and accounting (AAA) service. For details, see the Configuring AAA.

Protocols and Standards

- HTTP: RFC1945 and RFC2068

- HTTPS: RFC2818
- SNMP: RFC1157 and RFC 2578
- RADIUS: RFC2865, RFC2866, and RFC3576
- For the standards related to MAC SMS authentication, see the *CMCC WLAN Device Interface Standards V3.1.0_20130901 (MAC Address-Based Authentication Extension)*, *Zhejiang CMCCWLAN Fast Authentication Scheme – Interface Standards V1.1-2011.3.22*, and *WLAN Fast MAC Address-Based SMS Authentication Scheme V1.1-2011.3.21*.

1.2. Applications

| Application | Description |
|--|--|
| Basic Scenario of Web Authentication | Basic layer-2 authentication scenario, where a NAS, portal server, and RADIUS server constitute an authentication system which connects a client with the NAS through the layer-2 network. |

1.2.1. Basic Scenario of Web Authentication

Scenario

See Figure 1-1.

- Deploy a Web authentication scheme on the NAS.
- The client connected to the NAS needs to pass Web authentication before accessing the Internet.

Figure 1-1 Networking Topology of Web Authentication

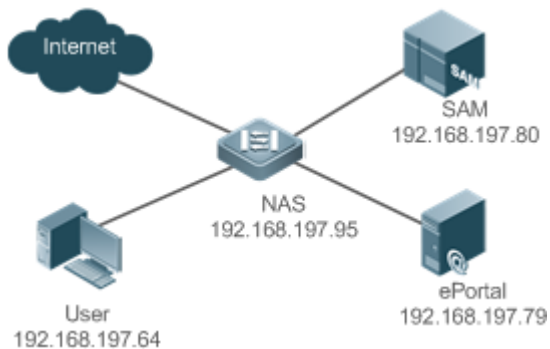

| | |
|----------------|---|
| Remarks | <p>Web authentication is applicable to both layer-2 and layer-3 networks. At layer 3, the source MAC address and VID of a packet are changed after it is routed, but the source IP address remains the same as the only identifier of a client. Therefore, the binding policy of Web authentication on layer-3 devices must adopt the IP-only binding mode. Here, layer-2 NAS is used as an example.</p> <p>RG-SAM program is installed on the RADIUS server. RG-ePortal program is installed on the portal server.</p> |
|----------------|---|

Deployment

- Enable Web authentication on the client-accessed interface or globally on the NAS (globally on EG devices).
- Configure the ePortal server and the communication key on the NAS (for only Ruijie First-Generation and Second-Generation Web Authentication).
- Configure the Simple Network Management Protocol (SNMP) communication parameters of the ePortal server on the NAS (for only Ruijie First-Generation and Second-Generation Web Authentication).
- Configure the consistent communication parameters on the ePortal server and SAM server (for only Ruijie First-Generation Web Authentication).
- Create user accounts on the SAM server.
- Configure AAA and method lists on the NAS (for only Ruijie Second-Generation and iPortal Web Authentication).
- Configure the IP address of the SAM server on the NAS (for only Ruijie Second-Generation and iPortal Web Authentication).
- Configure the names of the Web authentication method lists on the NAS (for only Ruijie Second-Generation and iPortal Web Authentication).

1.3. Features

Basic Concepts

▾ Ruijie First-Generation Web Authentication

Ruijie First-Generation Web Authentication should cooperate with the RG-ePortal software. The server installed with RG-ePortal provides a login page to submit user authentication information, and initiates an authentication request to the RADIUS server directly. After authentication succeeds, the NAS gets user information delivered through the SNMP protocol, and thereby controls user access permissions. Communication during Web authentication of this version depends on private SNMP nodes. Moreover, the ePortal server takes the place of the NAS in authentication and accounting, which relieves the NAS from service burden.

▾ Ruijie Second-Generation Web Authentication

Ruijie Second-Generation Web Authentication complies with the *CMCC WLAN Service Portal Specification*. The portal server is responsible only for Webpage interaction with users. The NAS interacts with the RADIUS server to implement authentication. The interaction between the portal server and the NAS complies with the *CMCC WLAN Service Portal Specification*. The portal server provides a login page for users to submit their information, and informs the NAS of user information through the portal protocols. The NAS completes authentication by interacting with the RADIUS server based on the user information, assigns access permissions to authenticated clients, and returns authentication results to the portal server.

The implementation process of Ruijie Second-Generation Web Authentication is mainly completed on the NAS. This raises a higher demand on the NAS's capability to handle heavy tasks. Meanwhile, the portal server is simplified. The standard *CMCC WLAN Service Portal Specification*, which gains highly industry support, enables various vendors to develop compatible products.

➤ Ruijie iPortal Web Authentication

In Ruijie iPortal Web Authentication, the NAS integrates Webpage interaction of the portal server and partial authentication interaction of the RADIUS server. The NAS has a default authentication page suite. It can be customized according to the configuration described in this manual. Then, download the configured page suite to the storage medium of the NAS for effect.

➤ Version Comparison

Authentication roles:

- Client: Its functions are the same among the three types of Web authentication.
- NAS: In Ruijie First-Generation Web Authentication, the NAS implements only URL redirection and exchanges user login/logout notifications with the portal server. In Ruijie Second-Generation Web Authentication, the NAS is responsible for redirecting and authenticating users as well as notifying the portal server of authentication results. In Ruijie iPortal Web authentication, the NAS integrates multiple functions including the URL redirection, Webpage interaction, and authentication.
- Portal server: In Ruijie First-Generation Web Authentication, the portal server is responsible for interaction with clients through Webpages, authenticating users, and notifying the NAS of authentication results. In Ruijie Second-Generation Web Authentication, the portal server is responsible for interacting with clients through Webpages, notifying the NAS of users' authentication information, and receiving authentication results from the NAS. In Ruijie iPortal Web Authentication, the portal server is built into the NAS and provides simplified functions, mainly responsible for Web page interaction with clients.
- RADIUS server: Its functions are the same among the three types of Web authentication.

Authentication process:

- In Ruijie Second-Generation Web Authentication, the authentication and accounting functions are transferred from the portal server to the NAS.
- Because authentication proceeds on the NAS, the second-generation NAS does not need to wait for the authentication results notified by the portal server as the first generation.
- Ruijie iPortal Web Authentication simplifies and integrates the features of the first- and second- generation portal servers into the NAS.

Logout process:

- In Ruijie First-Generation Web Authentication, a logout action may be triggered by a notification from the portal server, or traffic detection or port status detection performed by the NAS. In Ruijie Second-Generation Web Authentication, a logout action may be triggered by a notification from the portal server, a kickout notification from the RADIUS server, or traffic detection or port status detection performed by the NAS. In Ruijie iPortal Web Authentication, a logout action may be triggered by the voluntary logout of a user through clicking the **Logout** button on the online page, a kickout notification from the RADIUS server, or traffic detection or port status detection performed by the NAS.
- In Ruijie First-Generation Web Authentication, Accounting Stop packets are sent by the portal server. In Ruijie Second-Generation Web Authentication, Accounting Stop packets are sent by the NAS, the same as Ruijie iPortal Web Authentication.

- i** The selection of the Web authentication versions depends on the type of the portal server in use.
- i** Command parameters in this document may be shared by the three Web authentication versions or not. Read through this document carefully to avoid parameter misconfiguration that will affect Web authentication.

Overview

| Feature | Description |
|---|---|
| Ruijie First-Generation Web Authentication | The portal server is deployed and supports only Ruijie First-Generation Web Authentication. |
| Ruijie Second-Generation Web Authentication | The portal server is deployed and complies with the <i>CMCC WLAN Service Portal Specification</i> . |
| Ruijie iPortal Web Authentication | The portal server is not deployed, and the NAS supports Webpage interaction. |

1.3.1. Ruijie First-Generation Web Authentication

HTTP Interception

HTTP interception means the NAS intercepts to-be-forwarded HTTP packets. Such HTTP packets are initiated by the browsers of the clients connected to the NAS, but they are not destined for the NAS. For example, when a client attempts to visit the website www.google.com using the Internet Explorer, the NAS is expected to forward the HTTP request packets to the gateway. If HTTP interception is enabled, these packets will not be forwarded.

After HTTP interception is successful, the NAS redirects the HTTP requests from the client to itself to establish a session between them. Then, the NAS pushes a Webpage to the client through HTTP redirection, which can be used for authentication, software downloading or other purposes.

You can specify the clients and destination interfaces to enable or disable HTTP interception for Web authentication. In general, HTTP requests from unauthenticated clients will be intercepted, and those from authenticated clients will not. HTTP interception is the foundation of Web authentication. Web authentication is automatically triggered once HTTP interception succeeds.

HTTP Redirection

According to HTTP protocols, after the NAS receives a HTTP GET or HEAD request packet from a client, a packet with 200 (Ok) status code is replied if it is able to provide the required resources, or a packet with 302 (Moved Temporarily) status code is returned if unable. Another URL is provided in the 302 packet. After receiving the packet, the client may resend a HTTP GET or HEAD request packet to the new URL for requesting resources. This process is called redirection.

HTTP redirection is an important procedure following HTTP interception in Web authentication. It takes the advantage of 302 status code defined in HTTP protocols. HTTP interception creates a session between the NAS and a client. The client sends HTTP GET or HEAD request packets (which should have been sent to another site) to the NAS. The NAS responds with a 302 packet with a specific redirection page. Thereby, the client resends the requests to the redirection page.

Because more and more application programs run HTTP protocols, the use of the 302 redirection packet may divert a large amount of HTTP traffic (not sent by browsers) to the portal server, which will affect network authentication. To address this problem, HTTP redirection technology on the NAS adopts noise reduction to replace the 302 packets with the **js** script.

Working Principle

Figure 1-1 shows the networking topology of Web authentication.

First-generation Webauth roles:

1. Authentication client: Is usually a browser running HTTP protocols. It sends HTTP requests for accessing the Internet.
2. NAS: Is an access-layer device in a network (for example, a wireless access point [AP] on a wireless network). The NAS is directly connected to clients and must be enabled with Web authentication.
3. Portal server: Provides a Web page for Web authentication and related operations. After receiving an HTTP authentication request from a client, the portal server extracts account information from the request, sends the information to the RADIUS server for authentication, and notifies the client and NAS of the authentication result. Figure 1-1 shows Ruijie ePortal server.
4. RADIUS server: Provides the RADIUS-based authentication service to remote clients. The portal server extracts users' authentication account information from HTTP packets and initiates authentication requests to the RADIUS server through the RADIUS protocol. The RADIUS server returns the authentication result to the portal server through the RADIUS protocol. Figure 1-1 shows the RADIUS server installed with the RG-SAM program.

First-generation Webauth process:

1. Before authentication, the NAS intercepts all HTTP requests from a client and redirects these requests to the iPortal server. Thereafter, an authentication page is displayed on the browser.
2. During authentication, the client enters information, for example, username, password, and verification code, on the Webauth URL to interact with the portal server and complete authentication.
3. After the user is authenticated, the portal server notifies the NAS that the client has passed authentication, and the NAS allows the client to access resources on the Internet.

Figure 1-2 shows the flowchart of Ruijie First-Generation Web Authentication by using an AP as the NAS.

Figure 1-2 Flowchart of Ruijie First-Generation Web Authentication

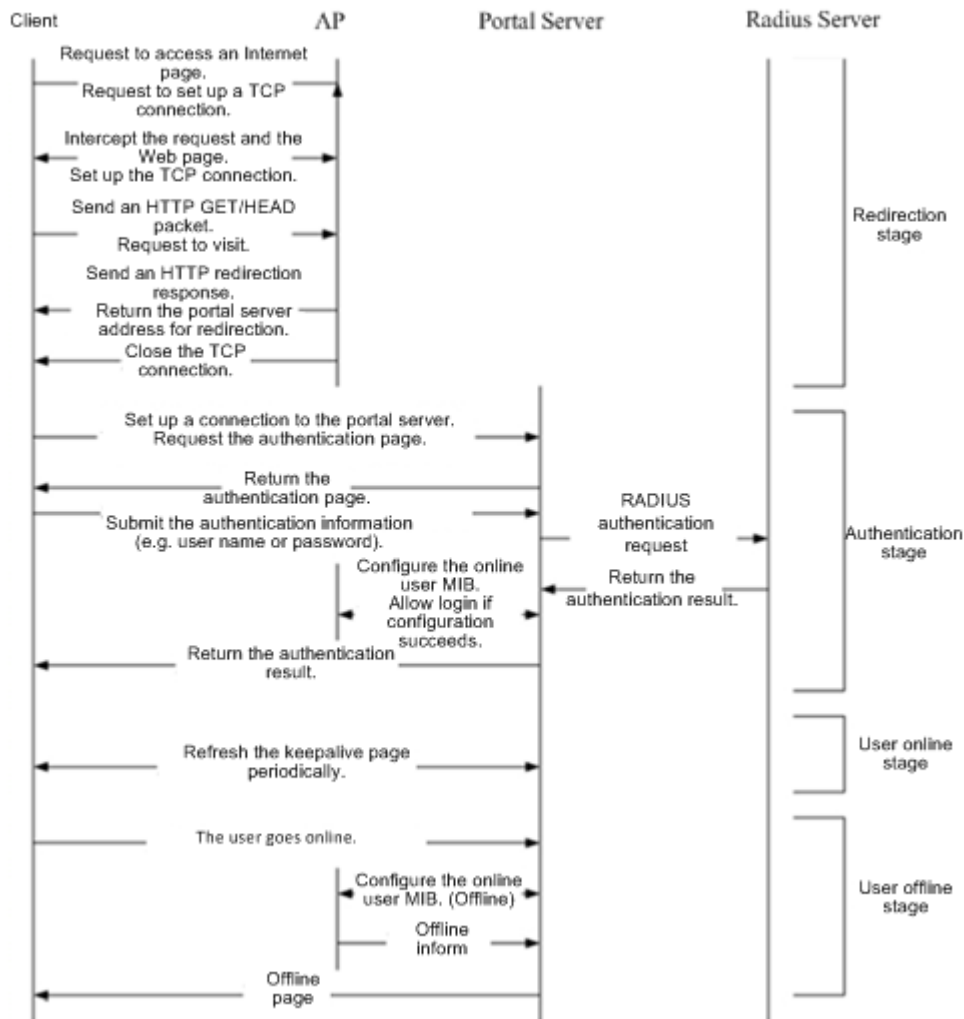

First-generation client logout process:

There are two scenarios of client logout. One scenario is detected by the NAS that a client gets offline for the maximum online time is out, the upper traffic limit is reached, or the link is disconnected. The other scenario is detected by the portal server that a client logs out by clicking the **Logout** button on the logout page or the keep-alive page is invalid.

1. Scenario 1: The NAS detects a client to logout and informs the portal server. Then the portal server deletes the user information on the NAS through SNMP and displays a logout page to the client.
2. Scenario 2: The portal server detects a client to logout and informs the NAS through SNMP and displays a logout page to the client.
3. In the two scenarios, the portal server sends an Accounting Stop request to the RADIUS server and notifies the RADIUS server that the client has logged out.

Related Configuration

- [Configuring the First-Generation Webauth Template](#)

By default, the first-generation Webauth template is not configured.

Run the **web-auth template eportalv1** command in global configuration mode to create the first-generation Webauth template.

The template is used to implement Web authentication.

📌 Configuring the IP Address of the Portal Server

By default, the IP address of the portal server is not configured.

Run the **ip {ip-address}** command in template configuration mode to configure the IP address of the portal server.

Any request packets to access the portal server will be filtered and rate-limited by the NAS.

📌 Configuring the Webauth URL of the Portal Server

By default, the Webauth URL of the portal server is not configured.

Run the **url {url-string}** command in template configuration mode to configure the Webauth URL of the portal server.

The URL to which clients are redirected is the address of the Webauth URL provided by the portal server.

📌 Specifying the Webauth Binding Mode

The default Webauth binding mode is IP-MAC binding mode.

Run the **bindmode** command in template configuration mode to specify the Webauth binding mode.

In Web authentication on layer-3 networks, the source MAC address in a packet is changed after the packet is routed. In such case, configure the IP-only binding mode.

📌 Configuring the Webauth Communication Key

By default, the Webauth communication key is not configured.

Run the **web-auth portal key {string}** command in global configuration mode to configure the Webauth communication key.

The communication key is used to encrypt URL parameters to avoid information disclosure.

📌 Enabling Ruijie First-Generation Web Authentication

By default, Ruijie First-Generation Web Authentication is disabled.

Run the **web-auth enable** command in interface configuration mode to enable Ruijie First-Generation Web Authentication on the client-connected ports.

After Web authentication is enabled, the unauthenticated clients connecting to a port will be redirected to the Webauth URL.

📌 Configuring the SNMP-Server Host

By default, the SNMP-server host and community string are not configured.

Run the **snmp-server host {ip-address} version 2c {community-string} web-auth** command in global configuration mode to configure the SNMP-server host and community string for Web authentication.

The SNMP-server host is configured to receive Inform/Trap packets of user logout.

▾ Configuring the SNMP-Server Community String

By default, the SNMP-server community string is not configured.

Run the **snmp-server community** *{community-string}* **rw** command in global configuration mode to configure the SNMP-server community string.

The SNMP-server community string is configured to read/write user information from/to the NAS.

▾ Enabling the SNMP Trap/Inform Function

By default, the SNMP Trap/Inform function is disabled.

Run the **snmp-server enable traps web-auth** command in global configuration mode to enable the SNMP Trap/Inform function.

The SNMP Trap/Inform function is configured to enable the NAS to inform the portal server of user logout.

1.3.2. Ruijie Second-Generation Web Authentication

HTTP Interception

Same as the HTTP interception technology of Ruijie First-Generation Web Authentication.

HTTP Redirection

Same as the HTTP redirection technology of Ruijie First-Generation Web Authentication.

Working Principle

Figure 1-1 shows the networking topology of Web authentication.

Second-generation Webauth roles:

1. Authentication client: Is usually a browser running HTTP protocols. It sends HTTP requests for accessing the Internet.
2. NAS: Is an access-layer device in a network (for example, an AP on a wireless network). The NAS is directly connected to clients and must be enabled with Web authentication. The NAS receives user authentication information from the portal server, sends authentication requests to the RADIUS server, determines whether users can access the Internet according to authentication results, and returns the authentication results to the portal server.
3. Portal server: Provides a Web page for Web authentication and related operations. After receiving an HTTP authentication request from a client, the portal server extracts account information from the request, transfers the information to the NAS, and displays the authentication result returned by the NAS to the user on a page. Figure 1-1 shows Ruijie ePortal server.
4. RADIUS server: Provides the RADIUS-based authentication service to remote clients. Figure 1-1 shows the RADIUS server installed with the RG-SAM program.

Second-generation Webauth process:

1. Before authentication, the NAS intercepts all HTTP requests from a client and redirects these requests to the iPortal server. Thereafter, an authentication page is displayed on the browser.

2. During authentication, the client enters information, for example, username, password, and verification code, on the Webauth URL to interact with the portal server.
3. The portal server sends the user authentication information to the NAS.
4. The NAS initiates authentication to the RADIUS server and returns the authentication result to the portal server.
5. The portal server displays the authentication result (success or failure) to the user on a page.

Figure 1-3 Flowchart of Ruijie Second-Generation Web Authentication

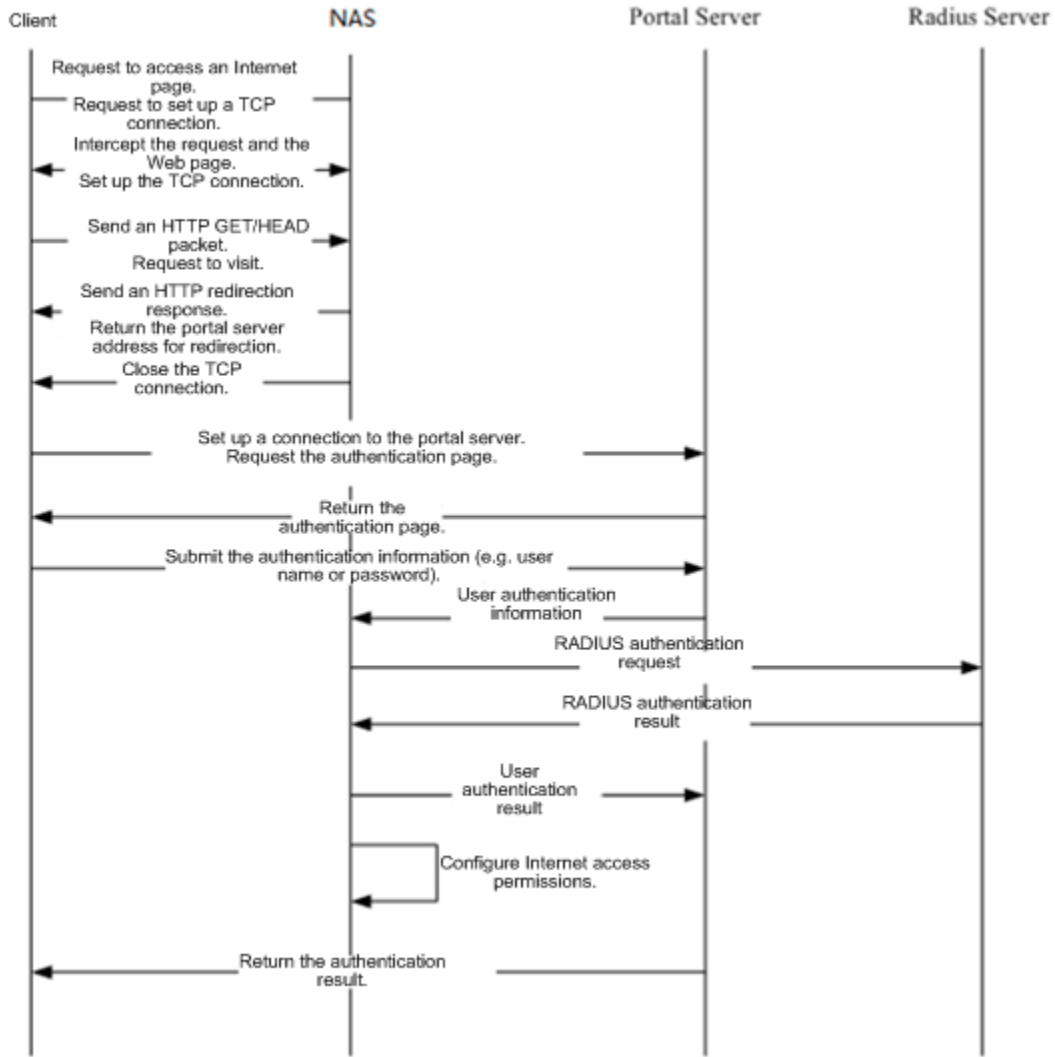

Second-generation client logout process:

There are two scenarios of client logout. One scenario is detected by the NAS that a client gets offline for the maximum online time is out, the upper traffic limit is reached, or the link is disconnected. The other scenario is detected by the portal server that a client logs out by clicking the **Logout** button on the logout page or the keep-alive page is invalid.

1. When a user clicks the **Logout** button on the online page, the portal server notifies the NAS to get the user offline.

2. The NAS gets a client offline with traffic lower than the threshold based on the parameters of user online traffic detection.
3. When the RADIUS server plans to force a client offline based on a certain policy, the NAS notifies the portal server to push a logout page to the client.

Related Configuration

▾ [Configuring the Second-Generation Webauth Template](#)

By default, the second-generation Webauth template is not configured.

Run the **web-auth template**{*eportalv2* | *template-name v2*} command in global configuration mode to create a second-generation Webauth template.

The template is used to implement Web authentication.

▾ [Configuring the IP Address of the Portal Server](#)

By default, the IP address of the portal server is not configured.

Run the **ip** { *ip-address* } command in template configuration mode to configure the IP address of the portal server.

Any request packets to access the portal server will be filtered and rate-limited by the NAS.

▾ [Configuring the Webauth URL of the Portal Server](#)

By default, the Webauth URL of the portal server is not configured.

Run the **url** {*url-string*} command in template configuration mode to configure the Webauth URL of the portal server.

The URL to which clients are redirected is the address of the Webauth URL provided by the portal server.

▾ [Specifying the Webauth Binding Mode](#)

The default Webauth binding mode is IP-MAC binding mode.

Run the **bindmode** command in template configuration mode to specify the Webauth binding mode.

In Web authentication on layer-3 networks, the source MAC address in a packet is changed after the packet is routed. In such case, configure the IP-only binding mode.

▾ [Configuring the Webauth Communication Key](#)

By default, the Webauth communication key is not configured.

Run the **web-auth portal key** { *string* } command in global configuration mode to configure the Webauth communication key.

The communication key is used to encrypt URL parameters to avoid information disclosure.

▾ [Enabling Ruijie Second-Generation Web Authentication](#)

By default, Ruijie Second-Generation Web Authentication is disabled.

Run the **web-auth enable** {*eportalv2* | *template-name v2*} command in interface configuration mode to enable Ruijie Second-Generation Web Authentication on the client-connected ports.

After Web authentication is enabled, the unauthenticated clients connecting to a port will be redirected to the Webauth URL.

↳ Enabling AAA

By default, AAA is disabled.

Run the **aaa new-model** command in global configuration mode to enable AAA.

Ruijie Second-Generation Web Authentication relies on AAA. Enable AAA before you implement the former.

↳ Configuring the RADIUS-Server Host and Communication Key

By default, the RADIUS-server host and communication key are not configured.

Run the **radius-server host** command in global configuration mode to configure the RADIUS-server host and communication key.

The RADIUS-server host is responsible for authenticating users.

↳ Configuring an AAA Method List for Ruijie Second-Generation Web Authentication

By default, no AAA method list is configured for Ruijie Second-Generation Web Authentication.

Run the **aaa authentication web-auth** command in global configuration mode to configure an AAA method list for Ruijie Second-Generation Web Authentication.

The AAA authentication method list is used for interaction during the Webauth process.

↳ Configuring an AAA Method List for Ruijie Second-Generation Web Accounting

By default, no AAA method list is configured for Ruijie Second-Generation Web Accounting.

Run the **aaa accounting network** command in global configuration mode to configure an AAA method list for Ruijie Second-Generation Web Accounting.

The AAA method list for Web accounting is used for accounting interaction during the Webauth process.

↳ Specifying an AAA Method List

The default AAA method list is used if no list is specified.

Run the **authentication** command in template configuration mode to specify an AAA method list.

The AAA method list is specified to send authentication requests to AAA.

↳ Specifying an AAA Accounting Method List

The default AAA accounting method list is used if no list is specified.

Run the **accounting** command in template configuration mode to specify an AAA accounting method list.

The AAA accounting method list is specified to send accounting requests to AAA.

↳ Specifying the UDP Port of the Portal Server

By default, UDP Port 50100 is used.

Run the **port** command in template configuration mode to specify the UDP port of the portal server.

The UDP port is specified for the portal server to communicate with the NAS.

1.3.3. Ruijie iPortal Web Authentication

HTTP Interception

Same as the HTTP interception technology of Ruijie First-Generation Web Authentication.

HTTP Redirection

Same as the HTTP redirection technology of Ruijie First-Generation Web Authentication.

Working Principle

Compared with Ruijie First-Generation Web Authentication shown in Figure 1-1, Ruijie iPortal Web Authentication does not require the portal server.

iPortal Webauth roles:

1. Authentication client: Is usually a browser running HTTP protocols. It sends HTTP requests for accessing the Internet.
2. NAS: Is an access-layer device in a network. It is directly connected to clients in wired or wireless networks and must be enabled with Ruijie iPortal Web Authentication. The NAS resolves the account information that clients enter on a Webpage and sends authentication requests to the RADIUS server. It determines whether clients can access the Internet according to authentication results and pushes the authentication results to the browsers.
3. RADIUS server: Provides the RADIUS-based authentication service to remote clients. Figure 1-1 shows the RADIUS server installed with the RG-SAM program.

iPortal Webauth process:

1. Before authentication, the NAS intercepts all HTTP requests from a client and redirects these requests to the iPortal server. Thereafter, an authentication page is displayed on the browser.
2. During authentication, the client enters information, for example, username, password, and verification code, on the Webauth URL to interact with the iPortal server (NAS).
3. The NAS initiates authentication to the RADIUS server and displays the authentication result (success or failure) to the client on a page.

Client logout process:

1. The NAS gets a client offline after the **Logout** button on the Web page is clicked.
2. The NAS gets a client offline with traffic lower than the threshold based on the parameters of user online traffic detection.
3. When the RADIUS server forces a client offline based on a certain policy, the NAS pushes a logout page to the client.

Related Configuration

↘ [Configuring the iPortal Webauth Template](#)

By default, the iPortal Webauth template is not configured.

Run the **web-auth template iportal** command in global configuration mode to create an iPortal Webauth template.

The template is used to configure authentication-related parameters on the iPortal server.

↳ Customizing a Page Suite

By default, the factory file package is used.

Run the **page-suite** command in template configuration mode to specify the use of a page suite.

Before you specify the use of a page suite, download it to the flash memory.

↳ Configuring an Advertisement URL

By default, no advertisement URL is configured.

Run the **popup url** command in template configuration mode to configure the advertisement URL.

Advertisement URLs allow the push of specified pages to clients.

↳ Specifying the Advertisement Mode

The default advertisement mode is post-login mode.

Run the **popup mode** command in template configuration mode to specify the iPortal Webauth advertisement mode including pre-login mode and post-login mode.

↳ Specifying the Webauth Binding Mode

The default Webauth binding mode is IP-MAC binding mode.

Run the **bindmode** command in template configuration mode to specify the Webauth binding mode.

In Web authentication on layer-3 networks, the source MAC address in a packet is changed after the packet is routed. In such case, configure the IP-only binding mode.

↳ Enabling Ruijie iPortal Web Authentication

By default, Ruijie iPortal Web Authentication is disabled.

Run the **web-auth enable iportal** command in interface configuration mode to enable Ruijie iPortal Web Authentication on the client-connected ports.

After Web authentication is enabled, the unauthenticated clients connecting to a port will be redirected to the Webauth URL.

↳ Enabling AAA

By default, AAA is disabled.

Run the **aaa new-model** command in global configuration mode to enable AAA.

Ruijie iPortal Web Authentication relies on AAA. Enable AAA before you implement Web authentication.

↳ Configuring the RADIUS-Server Host and Communication Key

By default, the RADIUS-server host and communication key are not configured.

Run the **radius-server host** command in global configuration mode to configure the RADIUS-server host and communication key.

The RADIUS-server host in Web authentication is responsible for authenticating users.

📌 **Configuring an AAA Method List for Ruijie iPortal Web Authentication**

By default, no AAA method list is configured for Ruijie iPortal Web Authentication.

Run the **aaa authentication iportal** command in global configuration mode to configure an AAA method list for Ruijie iPortal Web Authentication.

The AAA authentication method list is used for interaction during the Webauth process.

📌 **Configuring an AAA Method List for Ruijie iPortal Web Accounting**

By default, no AAA method list is configured for Ruijie iPortal Web Accounting.

Run the **aaa accounting network** command in global configuration mode to configure an AAA method list for Ruijie iPortal Web Accounting.

The AAA accounting method list is used for accounting interaction during the Webauth process.

📌 **Specifying an AAA Method List**

The default AAA method list is used if no list is specified.

Run the **authentication** command in template configuration mode to specify an AAA method list.

The AAA method list is specified to send authentication requests to AAA.

📌 **Specifying an AAA Accounting Method List**

The default AAA accounting method list is used if no list is specified.

Run the **accounting** command in template configuration mode to specify an AAA accounting method list.

The AAA accounting method list is specified to send accounting requests to AAA.

1.3.4. Ruijie MAC Address-Based SMS Authentication

Working Principle

After an STA is associated with an SSID enabled with MAC address-based SMS authentication, the STA obtains an IP address through the Dynamic Host Configuration Protocol (DHCP). Then the STA is allowed to access the Internet. When the STA uses up the traffic allowed during a time period, the access controller (AC) initiates a MAC address binding query to the bound portal server. If the STA is bound with a MAC address, the portal server sends an authentication request. If the STA is not bound with a MAC address, the STA needs to re-perform authentication on the portal server before accessing the Internet.

📌 **SMS Authentication Process for Unbound STAs**

The following figure shows the process where an STA not bound with a MAC address associates the SSID enabled with MAC address-based SMS authentication to access the Internet. Compared with Ruijie Second-Generation Web Authentication, MAC address-based SMS authentication is added with the procedures of querying MAC address binding and notifying the bound portal server of user login/logout. The rest of the process is the same. If the STA selects the **Bind** check box when performing authentication on the portal server, the portal server will bind the STA with a MAC address. Next time the STA can access the Internet directly.

Figure 1-4 Flowchart of SMS Authentication for Unbound STAs



➤ SMS Authentication Process for Bound STAs

After an STA is bound with a MAC address, the user does not need to open the browser to perform authentication for Internet access. Network access is automatically completed after the STA is associated with a network, which greatly facilitates wireless network access.

Figure 1-5 Flowchart of SMS Authentication for Bound STAs

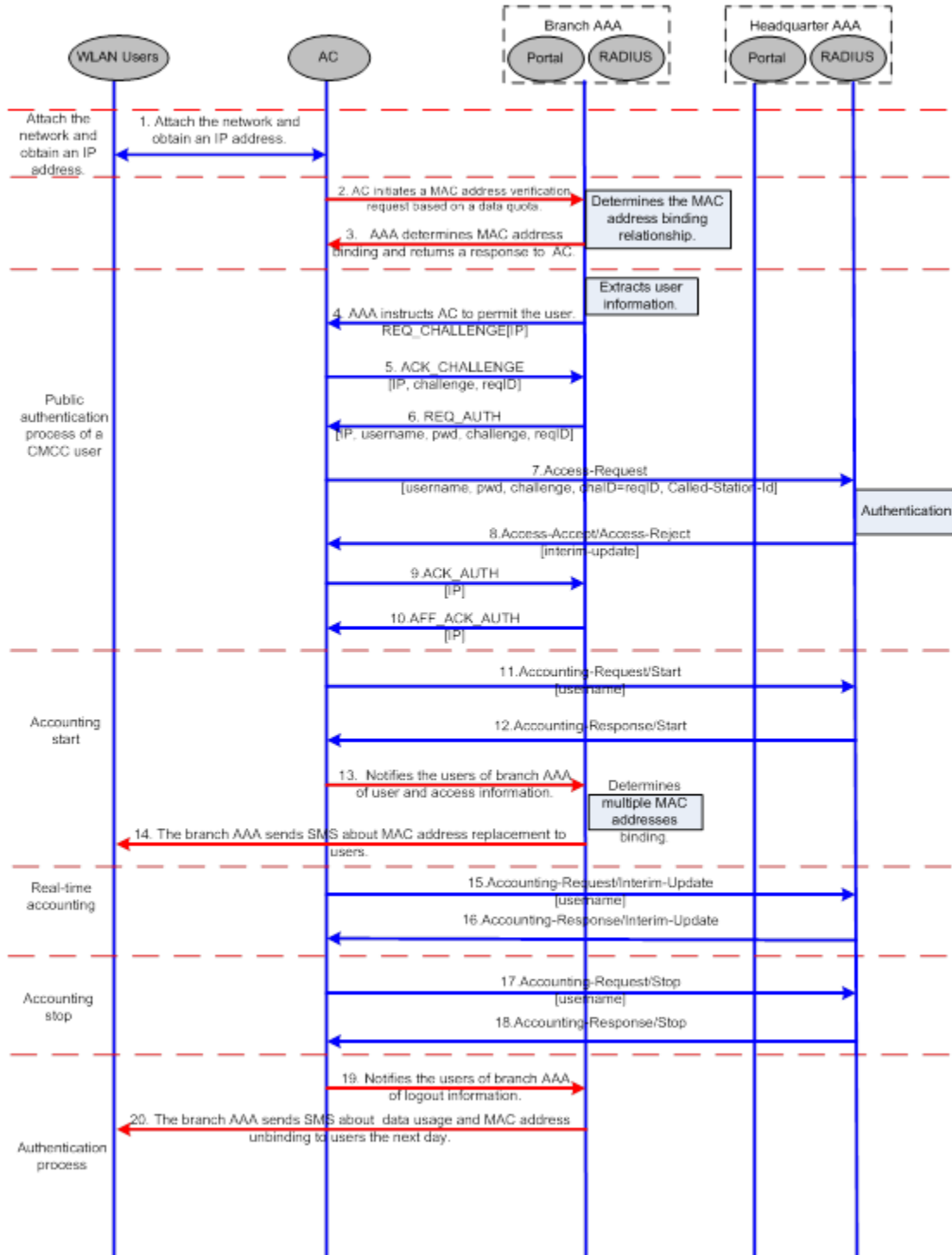

1.3.5. RIPT Web Authentication

Web authentication on wireless devices supports the Remote Intelligent Perception Technology (RIPT) function. When an AC is faulty or the AC is disconnected from an AP, the Web authentication function on the AP continues to provide the authentication service externally.

Working Principle

To enable RIPT, configure an RIPT AP group on an AC. For details, see the *Configuring RIPT*. In RIPT AP authentication mode, the configurations related to Web authentication on the AC are issued to the APs. The AP can function as access devices to provide the Web authentication service externally. (STAs do not need to perform Web authentication on the AC.) The information of the clients who pass authentication on the APs is synchronized to the AC and can be viewed on the AC.

↳ Issuing Configurations

In RIPT AP authentication mode, the configurations of AAA and RADIUS on the AC and port-based Web authentication control in RSNA will be issued to the APs. After that, the APs can provide WLAN services externally, including the Web authentication service.

↳ Synchronizing Client Information from the APs to the AC

If clients pass authentication by an RIPT AP which provides the Web authentication service externally, the information of the clients will be synchronized to the AC and can be viewed on the AC.

1.3.6. WiFiDog Web Authentication

HTTP Interception

Same as the HTTP interception technology of Ruijie First-Generation Web Authentication.

HTTP Redirection

Same as the HTTP redirection technology of Ruijie First-Generation Web Authentication.

Working Principle

The networking topology of WiFiDog Web authentication is the same as shown in Figure 1-1.

Roles involved in WiFiDog Web authentication:

1. Authentication client: Is usually a browser running HTTP protocols. It sends HTTP requests for accessing the Internet.
2. NAS: Is an access-layer device in a network (for example, an AP on a wireless network). The NAS is directly connected to clients and must be enabled with Web authentication. The NAS controls users' Internet access permissions, receives the token check requests or Internet access requests from authentication clients, and initiates identity check to the portal server.
3. Portal server: Provides a Web page for Web authentication and related operations. The portal server receives the HTTP-based authentication requests from authentication clients and extracts account information from the requests. When authentication is complete in the background, the authentication clients forward the authentication results to the NAS. The NAS redirects the authentication clients to a Webpage provided by the portal server.

4. Authentication server: Provides the authentication service. The authentication server negotiates with the portal server to determine the protocol (for example, RADIUS) used by authentication.

Main process of WiFiDog Web authentication:

1. Before authentication, the NAS intercepts all HTTP requests from a client and redirects these requests to the iPortal server. Thereafter, an authentication page is displayed on the browser.
2. During authentication, the client enters information, for example, username, password, and verification code, on the Webauth URL to interact with the portal server.
3. The portal server checks the validity of the client information in the background. If authentication fails, the portal server displays the failed authentication result to the client on a Web page. If authentication is successful, the portal server redirects the client to the NAS.
4. After receiving a request from the client, the NAS initiates check to the portal server. The NAS redirects the client to a Webpage provided by the portal server based on the check result.

Figure 1-6 Flowchart of WiFiDog Web Authentication

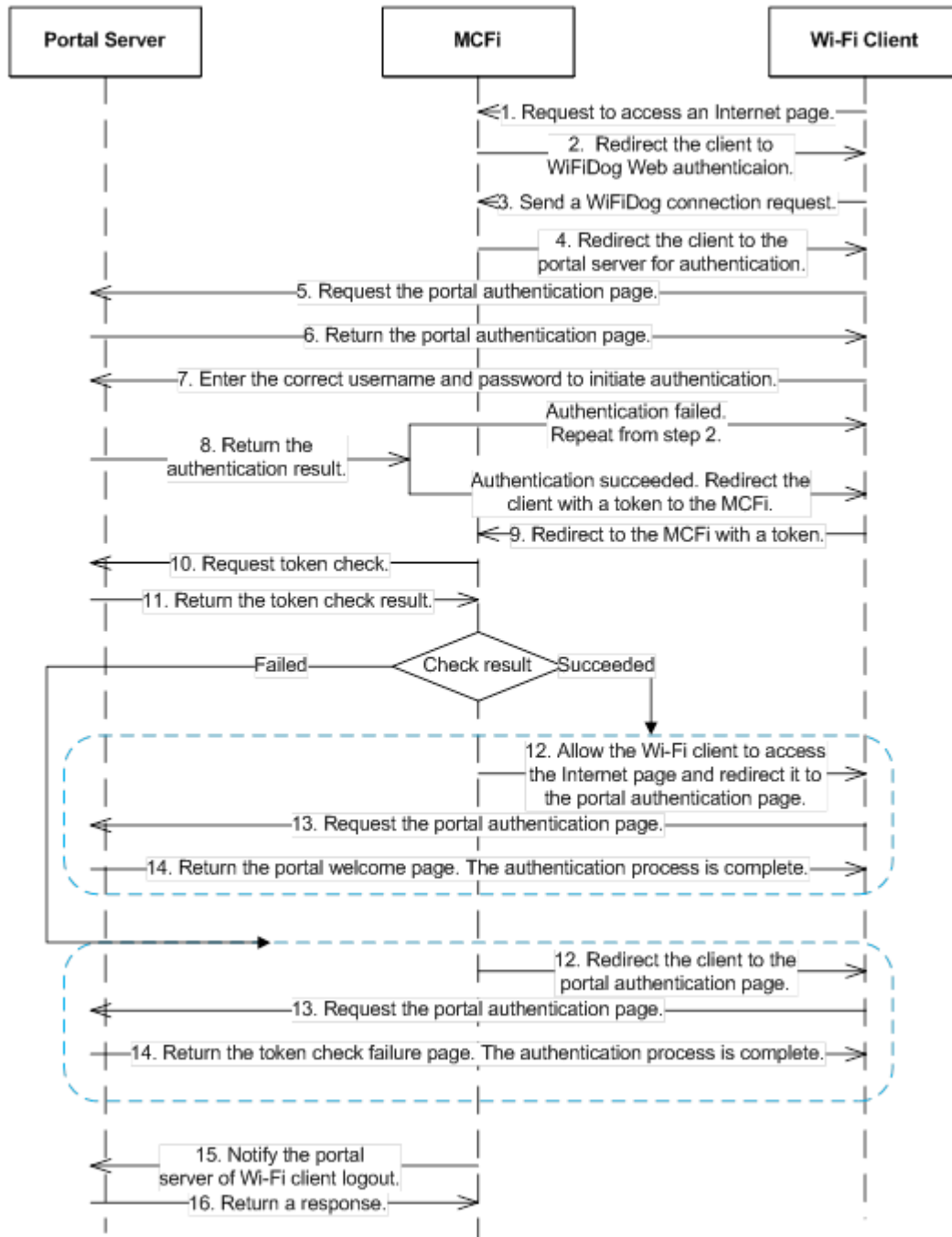

Client logout process:

There are two scenarios of client logout. One scenario is detected by the NAS that a client gets offline for the maximum online time is out, the upper traffic limit is reached, or the link is disconnected. The other scenario is detected by the portal server that a client logs out by clicking the **Logout** button on the logout page.

1. When a client clicks the **Logout** button, a logout request is sent to the portal server and NAS. (The logout request to the portal server and NAS may not be simultaneous, depending on the capability of the portal server.)

- The NAS gets a client offline with traffic lower than the threshold based on the parameters of user online traffic detection.

Related Configuration

↳ Configuring a WiFiDog Webauth Template

By default, the WiFiDog Webauth template is not configured.

Run the **web-auth template** { **wifidog** | *template-name* **wifidog** } command in global configuration mode to create a WiFiDog Webauth template.

The template is used to implement Web authentication.

↳ Configuring the IP Address of the Portal Server

By default, the IP address of the portal server is not configured.

Run the **ip** { *ip-address* } command in template configuration mode to configure the IP address of the portal server.

Any request packets to access the portal server will be filtered and rate-limited by the NAS.

↳ Configuring the Webauth URL of the Portal Server

By default, the Webauth URL of the portal server is not configured.

Run the **url** { *url-string* } command in template configuration mode to configure the Webauth URL of the portal server.

The URL to which clients are redirected is the address of the Webauth URL provided by the portal server.

↳ Configuring the IP Address of the NAS

By default, the IP address of the NAS is not configured.

Run the **nas-ip** { *ip-address* } command in template configuration mode to configure the IP address of the NAS.

Ensure that the configured IP address is accessible by clients.

↳ Enabling WiFiDog Web Authentication

By default, WiFiDog Web authentication is disabled.

Run the **web-auth enable** { **eportalv2** | *template-name* **v2** } command in interface configuration mode to enable Web authentication on the client-connected port.

After WiFiDog Web authentication is enabled, the unauthenticated clients connecting to a port will be redirected to the Webauth URL.

1.3.7. WeChat Web Authentication

HTTP Interception

Same as the HTTP interception technology of Ruijie First-Generation Web Authentication.

HTTP Redirection

Same as the HTTP redirection technology of Ruijie First-Generation Web Authentication.

Working Principle

The networking topology of WeChat Web authentication is the same as shown in Figure1-1.

Roles involved in WeChat Web authentication:

1. User: Is who sets up a Wi-Fi connection through WeChat to access the Internet.
2. In-shop AP: Is a fat AP or a fit AP.
3. Authentication server: Is a portal server or other authentication server like Marketing Cloud Platform (MCP), Wireless Marketing Cloud (WMC), or a third-party server.
4. WeChat server: Is a WeChat background server.

Process of scanning quick response (QR) codes by WeChat for authentication:

1. A user initiates a Wi-Fi connection request by scanning the QR code through WeChat.
2. The WeChat App identifies the QR code and calls the WeChat server (through the GSM by the mobile phone.)
3. The WeChat server checks the connection request based on the QR code policy.
4. The WeChat server returns an SSID to the WeChat user for its connection.
5. The WeChat user sends a connection request to the AP.
6. After connecting to the AP, the WeChat user sends a blacklist request, with the requested address being `http://10.1.0.6/redirect`. The request aims to inform the AP that the request is sent by a WeChat client.
7. After receiving the blacklist request, the AP sends a 302 redirection request, in which the auth parameter carries the MAC addresses of the mobile phone and AP in encryption mode.
8. After receiving the auth parameters, the WeChat client sends the WeChat server a whitelist request carrying the auth parameters for Wi-Fi connection authorization. Before that, the IP address of the WeChat server must be added to the whitelist of the AP to enable the AP to permit the authentication request to pass before the authentication on the AP is complete.
9. The AP determines that the requested IP address is in the whitelist and permits the whitelist request to pass to the WeChat server.
10. The WeChat server sends an HTTP-based authorization request to the device vendor server. The request maps interface 8. (Interface 13 must be called to set the device vendor server URL and token parameter in advance.)
11. The device vendor server implements authorization according to the authorization request and returns an authentication address and parameter (which maps the login parameter on interface 8).
12. The WeChat server returns the authentication address and parameter to the WeChat client.
13. The WeChat client requests the authentication address (by sending a login request).
14. The AP or device vendor server implements Internet access authentication. The AP permits the MAC address of the mobile phone to pass, and the device vendor server calls interface 7 to notify the WeChat server of successful Internet access (see step 15 in Figure 1-7). The AP returns a 302 redirection packet carrying the `res=success` parameter to the

WeChat client. The WeChat client determines that Internet access authorization is successful based on this parameter. A page indicating that a Wi-Fi connection is set up successfully is displayed on the WeChat client.

Figure 1-7 QR Code Scan Process in WeChat-Based Wi-Fi Connection Authentication

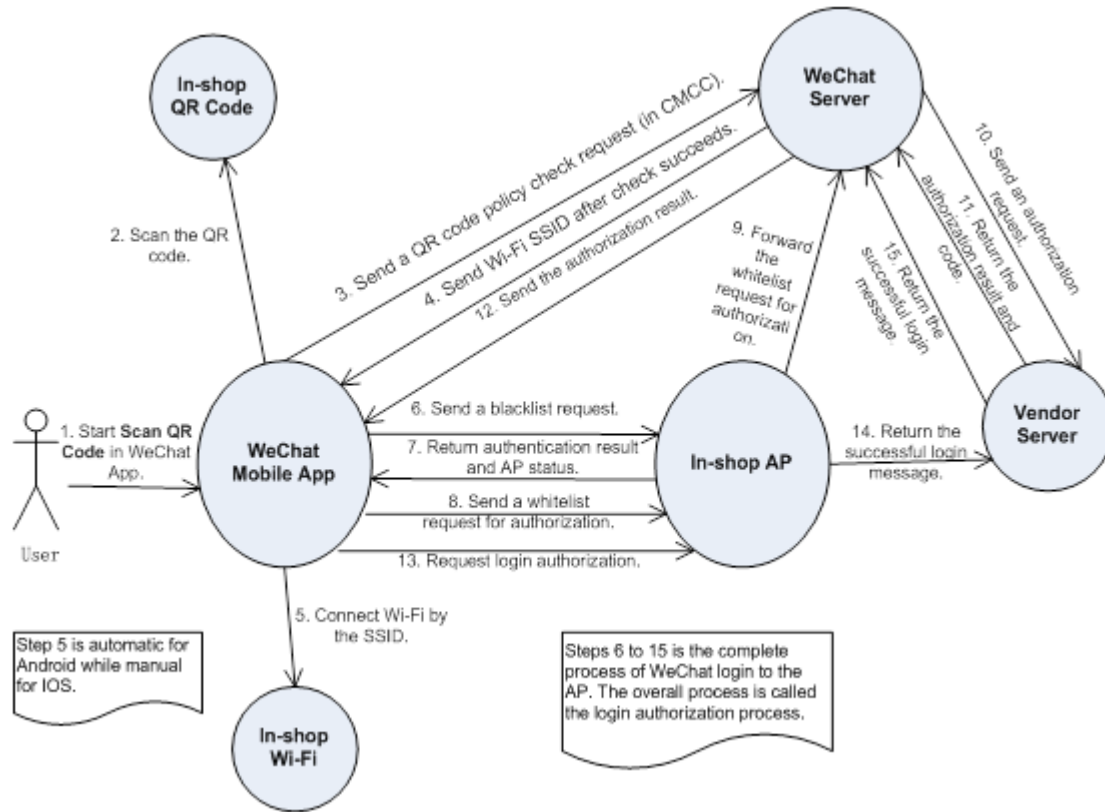

Process of the Internet access of multiple mobile devices by scanning dynamic QR codes on a PC:

A user starts a PC to set up a Wi-Fi connection and chooses to connect to an SSID (steps 1 and 2). When the user opens the browser and accesses a website, the browser sends a network request (step 3). The AP returns a 302 packet to display a portal authentication page on the browser. To enable a mobile phone to connect to the Internet by scanning a QR code displayed on the PC, the AP sends a request to the device vendor server (step 4), which calls interface 2 of the WeChat server to obtain the URL of the QR code photo (step 5). The WeChat server returns the URL of the QR code photo to the device vendor server (step 6), which then sends the URL to the AP (step 7). The AP sends the browser a 302 packet carrying the URL, which will be embedded into the portal authentication page. The mobile phone can scan the QR code (step 10) and connect to the Internet based on the normal access process.

Figure 1-8 Process Where Multiple Mobile Devices Access the Internet by Scanning Dynamic QR Codes on a PC

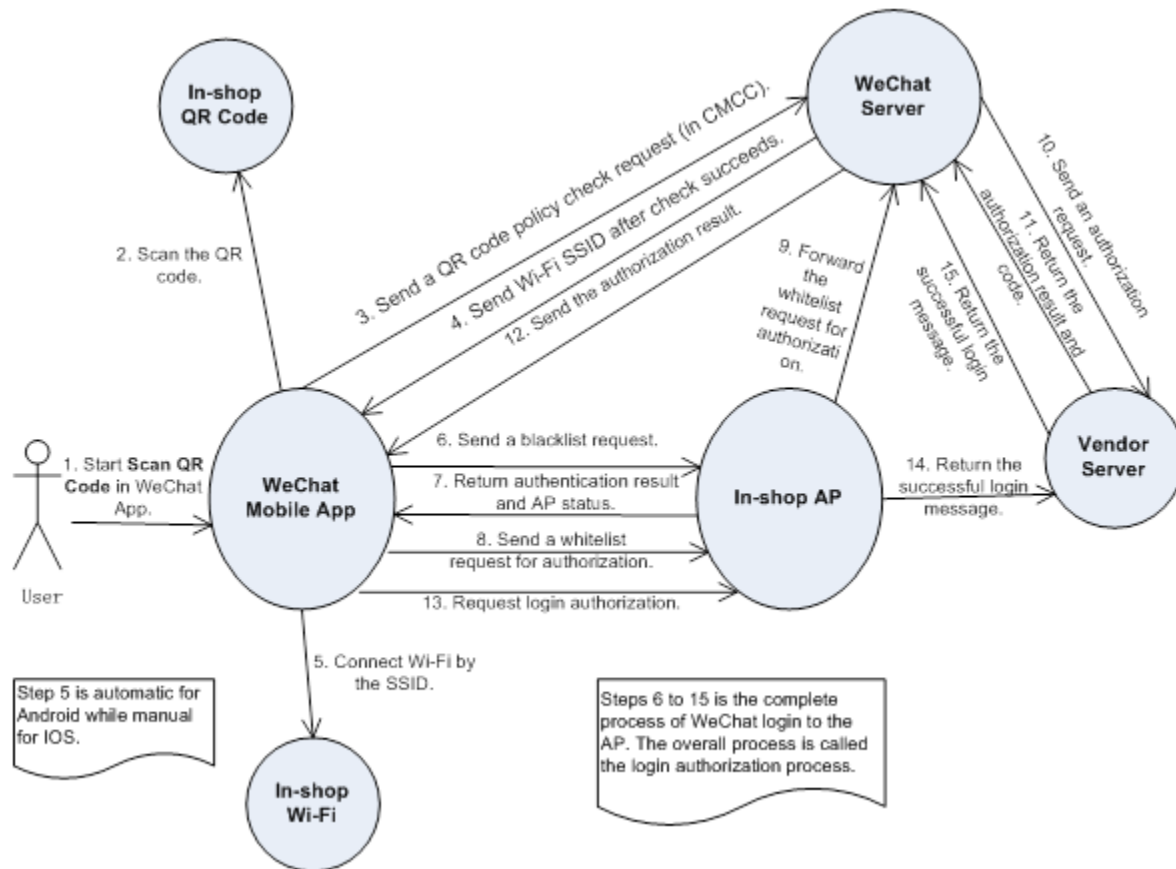

The NAS detects logout when a user's time is out, the data quota is reached, or the link is disconnected.

1. The NAS gets a client offline with traffic lower than the threshold based on the parameters of user online traffic detection.
2. The link disconnection duration depends on the parameters of anti-jitter configuration.

Related Configuration

Configuring a WeChat Webauth Template

By default, the WeChat Webauth template is not configured.

Run the **web-auth template {wechat |template-name wechat }** command in global configuration mode to create a WeChat Webauth template.

The template is used to implement Web authentication.

Configuring the IP Address of the Portal Server

By default, the IP address of the portal server is not configured.

Run the **ip {ip-address }** command in template configuration mode to configure the IP address of the portal server.

Any request packets to access the portal server will be filtered and rate-limited by the NAS.

↘ **Configuring the WeChat Webauth URL**

By default, no WeChat Webauth URL is configured.

Run the **service-url** {*url-string*} command in template configuration mode to configure the WeChat Webauth URL.

The URL address is used for the communication between the NAS and portal server.

↘ **Configuring the IP Address of the NAS**

By default, the IP address of the NAS is not configured.

Run the **nas-ip** command in template configuration mode to configure the IP address of the NAS.

Ensure that the configured IP address is accessible by users and must not be configured as a straight-through address.

↘ **Configuring the Portal Communication Key**

By default, no encryption key is configured.

Run the **key** {*key-string*} command in template configuration mode to configure an encryption key used for communicating with the portal server.

The encryption key is used to encrypt user authentication information and must be consistent with the key configured on the portal server.

↘ **Enabling Web Authentication**

By default, Web authentication is disabled.

Run the **web-auth portal** { **wechat** | *template-name wechat* } command in WLAN security configuration mode and **webauth** command to enable Web authentication control on the STA-connected port.

After Web authentication is enabled, the unauthenticated STAs connecting to the port will be redirected to a one-click Internet access page provided by the portal server, and the unauthenticated PCs connecting to the port will be redirected to a QR code page.

↘ **Enabling the Single Escape Function**

By default, the escape function is disabled.

Run the **escape interval** *seconds* **online-time** *minutes* command in template configuration mode to enable the escape function.

With the escape function, the NAS starts a timer when receiving a blacklist from an STA. (The interval of the timer is specified by the **interval** *seconds* parameter.) If the NAS does not receive a login authorization request from the STA when the timer times out, the NAS lets the STA escape and permits the corresponding entry to pass. The escape duration is specified by the **online-time** *minutes* parameter.

↘ **Enabling the Collective Escape Function**

By default, the collective escape function is disabled.

Run the **web-auth wechat-escape interval** *minutes* **times** *count* command in global configuration mode to enable the collective escape function.

After the function is configured, the device starts counting single escape users. If the number of single escape users reaches the threshold (specified by **times count**) within a certain interval (specified by **interval minutes**), the device starts collective escape and all users who gain access later are permitted to pass without authentication.

To cancel collective escape, run the **web-auth wechat-escape recover** command in global configuration mode to restore the single escape state.

▾ **Configuring Server Detection**

By default, server detection is disabled.

Run the **web-auth wechat-check interval minutes** command in global configuration mode to enable server detection.

After the function is configured, the device detects the server. If it fails to receive the serve response or the response is unavailable within a certain interval (specified by **interval minutes**) and the collective escape function is configured on the device, all users who gain access later are permitted to pass without authentication.

To cancel server detection, run the **no web-auth wechat-check** command in global configuration mode.

▾ **Configuring the Temporary Permit Function**



By default, the temporary permit function is disabled.

Run the **temporary-permit seconds** command in template configuration mode to configure the temporary permit function.



With the temporary permit function, when receiving a blacklist request from an STA, the NAS installs the STA's source IP address entry temporarily to permit the STA to pass. The aging time of the entry is specified by the **seconds** parameter.









1.4. Configuration

| Configuration | Description and Command | |
|--|---|---|
| Configuring Ruijie First-Generation Web Authentication |  (Mandatory) It is used to set the basic parameters of Ruijie First-Generation Web Authentication. | |
| | web-auth template eportalv1 | Configures the first-generation Webauth template. |
| | ip { ip-address } | Configures the IP address of the portal server. |
| | url { url-string } | Configures the Webauth URL of the portal server. |
| | web-auth portal key { key-string } | Configures the Webauth communication key. |
| | snmp-server community { community-string } rw | Configures the SNMP-server community string. |
| | snmp-server host { ip-address } inform version 2c { community-string } web-auth | Configures the SNMP-server host. |





| Configuration | Description and Command | |
|---|--|--|
| | snmp-server enable traps web-auth | Enables the SNMP-server Trap/Inform function. |
| | web-auth enable | Enables Ruijie First-Generation Web Authentication on an interface. |
| Configuring Ruijie Second-Generation Web Authentication |  (Mandatory) It is used to set the basic parameters of Ruijie Second-Generation Web Authentication. | |
| | aaa new-model | Enables AAA. |
| | radius-server host { <i>ip-address</i> } [auth-port <i>port-number</i>] [acct-port <i>port-number</i>] key { <i>string</i> } | Configures the RADIUS-server host and communication key. |
| | aaa authentication web-auth { default <i>list-name</i> } <i>method1</i> [<i>method2...</i>] | Configures an AAA method list for Web authentication. (RADIUS authentication is implemented.) |
| | aaa accounting network { default <i>list-name</i> } start-stop <i>method1</i> [<i>method2...</i>] | Configures an AAA method list for Web Accounting. (RADIUS accounting is implemented.) |
| | web-auth template { <i>eportalv2</i> <i>portal-namev2</i> } | Configures a second-generation Webauth template. |
| | ip { <i>ip-address</i> } | Configures the IP address of the portal server. |
| | url { <i>url-string</i> } | Configures the Webauth URL of the portal server. |
| | web-auth portal key { <i>key-string</i> } | Configures the Webauth communication key. |
| web-auth enable { eportalv2 <i>template-name</i> } | Enables Ruijie Second-Generation Web Authentication on an interface. | |
| Configuring Ruijie iPortal Web Authentication |  (Mandatory) It is used to set the basic parameters of Ruijie iPortal Web authentication. | |
| | aaa new-model | Enables AAA. |
| | radius-server host { <i>ip-address</i> } [auth-port <i>port-number</i>] [acct-port <i>port-number</i>] key { <i>string</i> } | Configures the RADIUS-server host and communication key. |
| | aaa authentication iportal { default <i>list-name</i> } <i>method1</i> [<i>method2...</i>] | Configures an AAA method list for Ruijie iPortal Web Authentication. (RADIUS authentication is implemented.) |
| | aaa accounting network { default <i>list-name</i> } start-stop <i>method1</i> [<i>method2...</i>] | Configures an AAA method list for Ruijie iPortal Web Accounting. (RADIUS accounting is implemented.) |
| web-auth template iportal | Configures the iPortal Web-auth template. | |



| Configuration | Description and Command | |
|--|---|---|
| | web-auth enable iportal | Enables Ruijie iPortal Web Authentication on an interface. |
| Configuring MAC Address-Based Authentication |  (Mandatory) It is used to set the basic parameters of MAC address-based SMS authentication. | |
| | aaa new-model | Enables AAA. |
| | radius-server host { <i>ip-address</i> } [auth-port <i>port-number</i>] [acct-port <i>port-number</i>] key { <i>string</i> } | Configures the RADIUS-server host and communication key. |
| | web-auth template eportalv2 | Configures a second-generation Webauth template. |
| | web-auth sms-flow interval <i>interval</i> threshold <i>flows</i> | Configures the detection interval and traffic threshold for MAC address-based SMS authentication. |
| | web-auth bind-portal <i>string</i> [type { group-spec local-spec }] | Configures the portal server bound for MAC address-based SMS authentication. |
| | web-auth winterface <i>string</i> | Sets the winterface field in the redirected URL. |
| | web-auth wlan-ac-ip <i>ipv4</i> | Sets the ACIP field in the redirection URL. |
| Configuring WiFiDog Authentication |  (Mandatory) It is used to set the basic parameters of WiFiDog authentication. | |
| | web-auth template wifidog | Configures a WiFiDog authentication template. |
| | ip { <i>ip-address</i> } | Configures the IP address of the portal server. |
| | url { <i>url-string</i> } | Configures the Webauth URL of the portal server. |
| | nas-ip { <i>ip-address</i> } | Configures the IP address of the NAS. |
| | web-auth portal wifidog | Specifies a WiFiDog authentication template. |
| | webauth | Enables Web authentication. |
| Configuring WeChat Web Authentication |  (Mandatory) It is used to set the basic parameters of WeChat authentication. | |
| | web-auth template { wechat (<i>portal-name</i> wechat) } | Configures a WeChat Webauth template. |
| | ip { <i>ip-address</i> } | Configures the IP address of the portal server. |
| | service-url { <i>url-string</i> } | Configures the WeChat Webauth URL. |
| | key { <i>key-string</i> } | Configures the portal communication key. |

| Configuration | Description and Command | |
|---|--|--|
| | web-auth portal wechat | Specifies a WeChat Webauth template. |
| | webauth | Enables Web authentication. |
| Specifying an Authentication Method List |  (Optional) It is used to specify an AAA authentication method list in template configuration mode. The name of the method list must be correctly specified. | |
| | authentication { <i>mlist-name</i> } | Specifies an AAA authentication method list(only for Ruijie Second-Generation Web Authentication and Ruijie iPortal Web Authentication.) |
| Specifying an Accounting Method List |  (Optional) It is used to specify an AAA accounting method in template configuration mode. The name of the method list must be correctly specified. | |
| | accounting { <i>mlist-name</i> } | Specifies an AAA accounting method list(only for Ruijie Second-Generation Web Authentication and Ruijie iPortal Web Authentication.) |
| Configuring the Communication Port of the Portal Server |  (Optional) It is used to specify the UDP port of the portal server in template configuration mode. The configured port number must be consistent with that on the RADIUS server. | |
| | port { <i>port-num</i> } | Configures the communication port of the portal server. |
| Specifying the Webauth Binding Mode |  (Optional) It is used to specify the entry binding mode in template configuration mode. | |
| | bindmode {<i>ip-mac-mode</i> <i>ip-only-mode</i>} | Specifies the template binding mode. |
| Customizing a Page Suite |  (Optional) It is used to configure the page suite used by Ruijie iPortal Web Authentication for a template. | |
| | page-suite <i>file-name</i> | Customizes a page suite for Ruijie iPortal Web Authentication. |
| Configuring an Advertisement URL |  (Optional) It is used to configure an iPortal Webauth advertisement URL in template configuration mode. | |
| | popup <i>url</i> | Configures an iPortal Webauth advertisement URL. |
| Specifying the Advertisement Mode |  (Optional) It is used to specify the iPortal Webauth advertisement mode in template configuration mode. | |
| | popup-mode [<i>login-popup</i> <i>online-popup</i>] | Specifies the iPortal Webauth advertisement mode. |
| Configuring the Format of the |  (Optional) It is used to configure the redirection URL format for a template. | |

| Configuration | Description and Command | |
|---|--|--|
| Webauth URL | fmt custom | Configures the format of the Webauth URL. |
| Configuring the Redirection HTTP Port |  (Optional) It is used to configure the TCP interception port for redirection, so that the packets on the specified port can be redirected when interception is enabled. | |
| | http redirect port { port-num } | Configures the redirection TCP port. |
| Configuring Rate Limit Webauth Logging |  (Optional) It is used to configure the syslog function in Web authentication. | |
| | web-auth logging enable { num } | Configures the rate limit Webauth logging. |
| Configuring the Maximum Number of HTTP Sessions for Unauthenticated Clients |  (Optional) It is used to adjust the HTTP session limit. The limit value needs to be increased when there are many sessions in the background. | |
| | http redirect session-limit { session-num } [port { port-session-num }] | Configures the maximum number of HTTP sessions for unauthenticated clients. |
| Configuring the HTTP Redirection Timeout |  (Optional) It is used to modify the timeout period for redirection connections. The timeout needs to be increased to complete redirection when the network condition is bad. | |
| | http redirect timeout { seconds } | Configures the HTTP redirection timeout. |
| Configuring the Straight-Through ARP Resource Range |  (Optional) It is used to permit the ARP of the specified addresses to pass. The gateway ARP must be permitted to pass when ARP check is enabled. | |
| | http redirect direct-arp { ip-address [ip-mask] } | Configures the straight-through ARP resource. |
| Configuring an Authentication-Exempted Address Range |  (Optional) It is used to exempt clients from authentication when accessing the Internet. | |
| | web-auth direct-host { ip-address [ip-mask] [arp] } [port interface-name mac-address] | Configures the range of the IP or MAC addresses of clients free from authentication. |
| Configuring the Interval for Updating Online User Information |  (Optional) It is used to configure the interval for updating online user information. | |
| | web-auth update-interval { seconds } | Configures the interval for updating online user information. |
| Configuring Portal Detection |  (Optional) It is used to detect the availability of the portal server. If it is not available, the services are switched to the standby portal server. This function must be used together with portal standby function. | |
| | web-auth portal-check [interval intsec [timeout tosec] [retransmit retries] | Configures the portal server detection interval, timeout period, and timeout retransmission times. |
| | web-auth ping [interval minutes] [retry times] | Configures the ping detection interval and timeout retransmission times. |

| Configuration | Description and Command |
|---|---|
| Configuring Portal Escape |  (Optional) It is used to allow new clients to access the Internet without authentication when the portal server is not available. |
| | web-auth portal-escape Configures portal escape. |
| Enabling DHCP Address Check |  (Optional) It is used to check whether the IP address of a client is allocated by the DHCP server. If not, the client's authentication request is denied. |
| | web-auth dhcp-check Checks whether the IP address of a client is assigned by the DHCP server. |
| Disabling Link Detection |  (Optional) It is used for jitter-off purposes to prevent the deletion of a client's Web authentication entry when the link of the client is disconnected, so that the client can access the Internet again without authentication. |
| | no web-auth sta-leave detection Disables link detection. |
| Disabling Portal Extension |  (Optional) It is used to disable portal extension in order to interwork with CMCC standard portal server. Portal extension must be enabled for interworking with Ruijie portal server software. |
| | no web-auth portal extension Disables portal extension. |
| Configuring a Whitelist and Blacklist |  (Optional) It is used to configure a blacklist to prevent authenticated clients from accessing some network resources, and a whitelist to allow unauthenticated clients to access some network resources. |
| | web-auth acl{black-ip ip black-port port black-url name white-url name} Configures a whitelist and blacklist. |
| Configuring Jitter-off Accounting |  (Optional) It is used to configure whether the jitter-off duration is included into the online duration, in order to improve accounting precision. The jitter-off duration depends on the jitter-off configuration of a specific product. |
| | web-auth accounting jitter-off Configures the jitter-off duration. (Use the no form of this command to disable this function.) |
| Configuring the Portal Communication Port |  (Optional) It is used to configure the port (source port) used for the communication between the NAS and portal server. |
| | ip portal source-interface interface-type interface-num Specifies the port used for the communication between the NAS and portal server. |
| Configuring a NDKEY-Compatible |  (Optional) It is used to configure the Webauth URL used in Web authentication to support the Shanghai NDKEY system. |

| Configuration | Description and Command | |
|---|---|--|
| Webauth URL | web-auth dkey-compatible url-parameter <i>string</i> | Configures a NDKEY-Compatibility compatible between the Shanghai NDKEY system and redirection Webauth URL. |
| Enabling NAT for Ruijie iPortal Web Authentication |  (Optional) It is used to configure Ruijie iPortal Web Authentication to support network address translation (NAT). | |
| | iportal nat enable | Enables NAT for Ruijie iPortal Web Authentication. |
| Configuring the iPortal HTTP Retransmission Times |  (Optional) It is used to configure the iPortal HTTP retransmission times. | |
| | iportal retransmit <i>count</i> | Configures the iPortal HTTP retransmission times. |
| Configuring Service Selection in Ruijie iPortal Web Authentication |  (Optional) It is used to configure the service type used by Ruijie iPortal Web Authentication. | |
| | iportal service [internet <i>internet-name</i>] [local <i>local-name</i>] | Configures the service type used by Ruijie iPortal Web Authentication. |
| Configuring the Accounting Method List of Web Authentication |  (Optional) It is used to configure an accounting method based on the template. | |
| | web-auth accounting v2 { default <i>name</i> } | Configures an accounting method based on the template. |
| Configuring a Web Authentication Method List |  (Optional) It is used to configure an authentication method based on the template. | |
| | web-auth authentication v2 { default <i>name</i> } | Configures an authentication method based on the template. |
| Enabling iOS Automatic Pop-up Window Control in WeChat-Based Authentication |  (Optional) It is used to enable the automatic display of a Web configuration page in iOS systems with wireless association. | |
| | http redirect adapter ios | Enables the automatic display of a Web configuration page in iOS systems with wireless association. |
| Configuring Online User Detection Under WLANSEC |  (Optional) It is used to configure online user detection under WLANSEC. | |
| | web-auth offline-detect interval <i>interval</i> flow <i>thredshold</i> | Configures online user detection under WLANSEC. |
| Configuring Transparent Transmission of the 0x05 Attribute of the Portal Protocol |  (Optional) It is used to configure transparent transmission of the 0x05 attribute of the portal protocol. | |
| | web-auth portal-attribute [5 <i>textinfo</i>] | Configures transparent transmission of the 0x05 attribute of the portal protocol. |

| Configuration | Description and Command | |
|--|--|--|
| Configuring Uniqueness Check of Portal Authentication Accounts |  (Optional) It is used to configure uniqueness check of portal authentication accounts. | |
| | web-auth portal-valid unique-name | Configures uniqueness check of portal authentication accounts. |
| Enabling the One-click Switch Configuration via WiFiDog |  (Optional) It is used to enable the one-click switch configuration via WiFiDog. | |
| | web-auth wifidog-template wlan-range portal-ip nas-ip url [perception] | Enables the one-click switch configuration via WiFiDog. |
| Enabling the One-click Switch Configuration via WeChat |  (Optional) It is used to enable the one-click switch configuration via WeChat. | |
| | web-auth wechat-template wlan-range portal-ip nas-ip [ios-adapter perception] | Enables the one-click switch configuration via WeChat. |

1.4.1. Configuring Ruijie First-Generation Web Authentication

Configuration Effect

Redirect unauthenticated clients to the Webauth URL to perform authentication.

Notes

N/A

Configuration Steps

▾ Configuring the Portal Server

- (Mandatory) To enable Web authentication successfully, you must configure and apply the portal server.
- When the NAS or convergence device finds an unauthenticated client attempting to access network resources through HTTP, it redirects the access request to the specified Webauth URL, where the client can initiate authentication to the portal server. If the IP address of the portal server is configured as a free network resource, unauthenticated clients can directly visit this IP address through HTTP.

▾ Configuring the Communication Key Between the NAS and Portal Server

- (Mandatory) To enable Web authentication successfully, you must configure the key used for the communication between the NAS or convergence device and portal server.
- When the NAS finds an unauthenticated client attempting to access network resources, it redirects the client to the specified Webauth URL, where the client can initiate authentication to the portal server. During the authentication process, the communication key is used to encrypt some data exchanged between the NAS and portal server to improve security.

▾ Setting the SNMP Parameters Between the NAS and Portal Server

- (Mandatory) To enable Web authentication successfully, you must set the SNMP network management parameters used for the communication between the NAS and portal server.

- The NAS or convergence device and portal server jointly manage authenticated clients through SNMP/MIB. A table of authenticated clients is managed by MIB on the NAS. The portal server is able to access the MIB to obtain client statistics so as to control client login and logout. When a client logs out, the NAS or convergence device will inform the portal server by Webauth Inform packets.

↳ Enabling Ruijie First-Generation Web Authentication on an Interface

- Mandatory.
- When Ruijie First-Generation Web Authentication is enabled in interface configuration mode, Web authentication is not enabled on any port by default. The users connecting to the port do not need to perform Web authentication.

Verification

- Check whether unauthenticated clients are required to perform authentication.
- Check whether authenticated clients can access the Internet normally.

Related Commands

↳ Configuring the First-Generation Webauth Template

| | |
|---------------------|---|
| Command | web-auth template eportalv1 |
| Parameter | N/A |
| Description | |
| Command Mode | Global configuration mode |
| Usage Guide | eportalv1 is the default template of Ruijie First-Generation Web Authentication. |

↳ Configuring the IP Address of the Portal Server

| | |
|---------------------|--|
| Command | ip {ip-address} |
| Parameter | Indicates the IP address of the portal server. |
| Description | |
| Command Mode | Webauth template configuration mode |
| Usage Guide | N/A |

↳ Configuring the Webauth URL of the Portal Server

| | |
|---------------------|---|
| Command | url {url-string} |
| Parameter | <i>url-string</i> : Indicates the Webauth URL of the portal server. |
| Description | |
| Command Mode | Webauth template configuration mode |
| Usage Guide | The URL starts with http:// or https:// . |

↳ Configuring the Format of the Webauth URL

| | |
|------------------------------|---|
| Command | fmt { ace ruijie } |
| Parameter Description | Indicates the format of the Webauth URL. |
| Command Mode | Webauth template configuration mode |
| Usage Guide | ACE association is supported when fmt is set to ace . |

↘ Specifying the Webauth Binding Mode

| | |
|------------------------------|--|
| Command | bindmode { ip-mac-mode ip-only-mode } |
| Parameter Description | Indicates the Webauth binding mode. |
| Command Mode | Webauth template configuration mode |
| Usage Guide | N/A |

↘ Specifying the Redirection Method

| | |
|------------------------------|--|
| Command | redirect { http js } |
| Parameter Description | Indicates the encapsulation format of redirected packets. |
| Command Mode | Webauth template configuration mode |
| Usage Guide | For JavaScript-incapable Apps, you need to specify the HTTP encapsulation format to trigger redirection. |

↘ Configuring the Webauth Communication Key

| | |
|------------------------------|--|
| Command | web-auth portal key {key-string} |
| Parameter Description | <i>key-string</i> : Indicates the Webauth communication key used for the communication between the NAS and portal server. The key contains up to 255 characters. |
| Command Mode | Global configuration mode |
| Usage Guide | N/A |

↘ Configuring the SNMP-Server Community String

| | |
|------------------------------|---|
| Command | snmp-server community {community-string}rw |
| Parameter Description | <i>community-string</i> : Indicates the community string. rw : Must be set to rw to support the read and write operations as the Set operation on MIB is required. |
| Command Mode | Global configuration mode |
| Usage Guide | The SNMP-server community string is used by the portal server to manage the online clients on the NAS or convergence device. |

↘ Configuring the SNMP-Server Host

| | |
|---------------------|---|
| Command | snmp-server host {ip-address} inform version 2c {community-string} web-auth |
| Parameter | <i>ip-address</i> : Indicates the IP address of the SNMP-server host, that is, the portal server. |
| Description | <i>community-string</i> : Configures the community string used to send an SNMP Inform message. |
| Command Mode | Global configuration mode |
| Usage Guide | <p>Configure the SNMP-server host to receive Webauth messages, including the type, version, community string, and other parameters.</p> <p>inform: Enables the SNMP Inform function. The NAS or convergence device will send a message to the portal server when a client logs out. The message type is set to Inform instead of Trap to avoid message loss.</p> <p>version 2c: Indicates SNMPv2 for SNMP Inform is not supported in all SNMP versions excluding SNMPv1.</p> <p>web-auth: Indicates the preceding parameters to be used for Web authentication.</p> <hr/> <p>For details regarding SNMP configuration and others, see the <i>Configuring SNMP</i>.</p> <p>The SNMP parameter version 2c listed here is aimed at SNMPv2. SNMPv3 is recommended if higher security is required for the SNMP communication between the NAS and portal server. To use SNMPv3, change SNMP Community to SNMP User, version 2c to SNMPv3, and set SNMPv3-related security parameters. For details, see the <i>Configuring SNMP</i>.</p> |

▾ Enabling the Webauth Trap/Inform Function

| | |
|---------------------|--|
| Command | snmp-server enable traps web-auth |
| Parameter | N/A |
| Description | |
| Command Mode | Global configuration mode |
| Usage Guide | <p>Configure the NAS or convergence device to send Webauth Trap and Inform messages externally.</p> <p>web-auth: Indicates Web authentication messages.</p> |

▾ Enabling Ruijie First-Generation Web Authentication on an Interface

| | |
|---------------------|------------------------------|
| Command | web-auth enable |
| Parameter | N/A |
| Description | |
| Command Mode | Interface configuration mode |
| Usage Guide | N/A |

Configuration Example

▾ Configuring Ruijie First-Generation Web Authentication

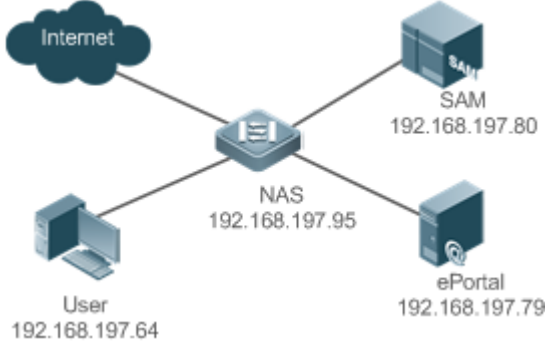
| | |
|---------------------------------------|--|
| <p>Scenario Figure 1-9</p> |  <p>The diagram illustrates a network topology for web authentication. At the center is a Network Access Server (NAS) with IP address 192.168.197.95. It is connected to four other components: the Internet (represented by a cloud), a Security Audit Manager (SAM) server with IP 192.168.197.80, an ePortal server with IP 192.168.197.79, and a User with IP 192.168.197.64. All connections are shown as bidirectional lines.</p> |
| <p>Configuration Steps</p> | <ul style="list-style-type: none"> ● On the NAS, configure the IP address of the ePortal server and the key (ruijie) used for communicating with the ePortal server. ● Configure the Webauth URL on the NAS. ● Set the SNMP network management parameters (community string: public) used for the communication between the NAS and ePortal server. ● Enable Web authentication on ports GigabitEthernet 0/2 and GigabitEthernet 0/3 on the NAS. |
| | <pre>Ruijie# config Enter configuration commands, one per line. End with CNTL/Z. Ruijie(config)#web-auth template eportalv1 Ruijie(config.tmpl.eportalv1)#ip 192.168.197.79 Ruijie(config.tmpl.eportalv1)#exit Ruijie(config)# web-auth portal key ruijie</pre> |
| | <pre>Ruijie(config)# web-auth template eportalv1 Ruijie(config.tmpl.eportalv1)#url http://192.168.197.79:8080/eportal/index.jsp Ruijie(config.tmpl.eportalv1)#exit</pre> |
| | <pre>Ruijie(config)# snmp-server community public rw Ruijie(config)# snmp-server enable traps web-auth Ruijie(config)# snmp-server host 192.168.197.79 inform version 2c public web-auth Ruijie(config)# exit</pre> |
| | <pre>Ruijie(config)# interface range GigabitEthernet 0/2-3 Ruijie(config-if-range)# web-auth enable Ruijie(config-if-range)# exit</pre> |
| <p>Verification</p> | <ul style="list-style-type: none"> ● Check whether Web authentication is configured successfully. |

| | |
|--|---|
| | <pre>Ruijie(config)#show running-config ... snmp-server host 192.168.197.79 inform version 2c public web-auth snmp-server enable traps web-auth snmp-server community public rw ... web-auth template eportalv1 ip 192.168.197.79 url http://192.168.197.79:8080/eportal/index.jsp ! web-auth portal key ruijie ... interface GigabitEthernet 0/2 web-auth enable ! interface GigabitEthernet 0/3 web-auth enable</pre> |
| | <pre>Ruijie#show web-auth control Port Control Server Name Online User Count ----- ... GigabitEthernet 0/20n eportalv1 0 GigabitEthernet 0/30n eportalv1 0 ...</pre> |
| | <pre>Ruijie#show web-auth template Webauth Template Settings: ----- Name: eportalv1 Url: http://17.17.1.21:8080/eportal/index.jsp Ip: 17.17.1.21 BindMode: ip-mac-mode</pre> |

| | |
|--|-------------------|
| | Type: v1 |
|--|-------------------|

Common Errors

- The SNMP parameters used for the communication between the portal server and NAS are configured incorrectly, causing authentication failures.
- Specify the IP-MAC binding mode to deploy Web authentication on layer-3 networks, causing authentication failures.
- When Web authentication is used in conjunction with VRRP, run the `snmp-server trap-source ip` command to specify the VRRP address; otherwise, the portal server cannot process Trap packets correctly.

1.4.2. Configuring Ruijie Second-Generation Web Authentication

Configuration Effect

Redirect unauthenticated clients to the Webauth URL to perform authentication. IPv6 is supported.

Notes

- Ruijie Second-Generation Web Authentication complies with the CMCC WLAN Service Portal Specification. Furthermore, it is extended to support Ruijie portal server. Perform compatible configuration based on the server performance in actual deployment. For details, see the subsequent chapter.
- When you configure the URL of the second-generation portal server, if the URL contains an IPv6 address, enclose it with a pair of square brackets, for example, `http://[2001::1]/index.jsp`.
- The `cmcc-normal` and `cmcc-ext1` parameters in the `fmt` command support only IPv4. If IPv6 is used, the configuration of the portal server is invalid.

Configuration Steps

↳ Enabling AAA

- (Mandatory) To enable Ruijie Second-Generation Web Authentication, you must enable AAA.
- The NAS is responsible for initiating authentication to the portal server through AAA in Ruijie Second-Generation Web Authentication.

↳ Configuring the RADIUS-Server Host and Communication Key

- (Mandatory) To enable Ruijie Second-Generation Web Authentication, you must configure the RADIUS server.
- Clients' account information is stored on the RADIUS server. The NAS needs to connect to the RADIUS server to validate a client.

↳ Configuring an AAA Method List for Web Authentication

- (Mandatory) To enable Ruijie Second-Generation Web Authentication, you must configure an AAA authentication method list.

- An AAA authentication method list associates Web authentication requests with the RADIUS server. The NAS selects an authentication method and server based on the method list.

▾ **Configuring an AAA Method List for Web Accounting**

- (Mandatory) To enable Ruijie Second-Generation Web Authentication, you must configure an AAA method list for Web accounting.
- An accounting method list is used to associate an accounting method and server. In Web authentication, accounting is implemented to record client fees.

▾ **Configuring the Portal Server**

- (Mandatory) To enable Ruijie Second-Generation Web Authentication, you must configure and apply the portal server.
- When the NAS or convergence device finds an unauthenticated client attempting to access network resources through HTTP, it redirects the access request to the specified Webauth URL, where the client can initiate authentication to the portal server. If the IP address of the portal server is configured as a free network resource, unauthenticated clients can directly visit this IP address through HTTP.

▾ **Configuring the Communication Key Between the NAS and Portal Server**

- (Mandatory) To enable Ruijie Second-Generation Web Authentication, you must configure the key used for the communication between the NAS or convergence device and portal server.
- When the NAS finds an unauthenticated client attempting to access network resources, it redirects the client to the specified Webauth URL, where the client can initiate authentication to the portal server. During the authentication process, the communication key is used to encrypt some data exchanged between the NAS and portal server to improve security.

▾ **Configuring the Portal Server in Global or Interface Configuration Mode**

- (Mandatory) To enable Ruijie Second-Generation Web Authentication, you must specify the use of the second generation portal server in global or interface configuration mode.
- The NAS first selects the portal server in interface configuration mode. If such a portal server does not exist, the NAS selects the portal server in global configuration mode. If such a portal server does not exist, eportalv1 is used by default. The NAS redirects users to the selected portal server.

▾ **Enabling Ruijie Second-Generation Web Authentication on an Interface**

- Mandatory.
- When Ruijie Second-Generation Web Authentication is enabled in interface configuration mode, Web authentication is not enabled on any port by default. The users connecting to the port do not need to perform Web authentication.

Verification

- Check whether unauthenticated clients are required to perform authentication.
- Check whether authenticated clients can access the Internet normally.

Related Commands

↳ Enabling AAA

| | |
|---------------------|---|
| Command | aaa new-model |
| Parameter | N/A |
| Description | |
| Command Mode | Global configuration mode |
| Usage Guide | You can configure the AAA authentication and accounting method lists only after AAA is enabled. |

↳ Configuring the RADIUS-Server Host and Communication Key

| | |
|---------------------|--|
| Command | radius-server host { <i>ip-address</i> } [auth-port <i>port-number1</i>] [acct-port <i>port-number2</i>] key { <i>string</i> } |
| Parameter | <i>ip-address</i> : Indicates the IP address of the RADIUS server host. |
| Description | <i>port-number1</i> : Indicates the authentication port. <i>port-number2</i> : Indicates the accounting port. <i>string</i> : Indicates the key string. |
| Command Mode | Global configuration mode |
| Usage Guide | By default, the authentication port number is 1812, and the accounting port number is 1813. |

↳ Configuring an AAA Method List for Web Authentication

| | |
|---------------------|---|
| Command | aaa authentication web-auth { default <i>list-name</i> } <i>method1</i> [<i>method2...</i>] |
| Parameter | <i>list-name</i> : Creates a method list. |
| Description | <i>method1</i> : Configures method 1. <i>method2</i> : Configures method 2. |
| Command Mode | Global configuration mode |
| Usage Guide | Ruijie Second-Generation Web Authentication adopts the RADIUS authentication method. |

↳ Configuring an AAA Method List for Web Accounting

| | |
|---------------------|--|
| Command | aaa accounting network { default <i>list-name</i> } start-stop <i>method1</i> [<i>method2...</i>] |
| Parameter | <i>list-name</i> : Creates a method list. |
| Description | <i>method1</i> : Configures method 1. <i>method2</i> : Configures method 2. |
| Command Mode | Global configuration mode |
| Usage Guide | Ruijie Second-Generation Web Authentication adopts the RADIUS accounting method. |

↳ Configuring the Second-Generation Webauth Template

| | |
|----------------|---|
| Command | web-auth template { <i>eportalv2</i> <i>portal-name v2</i> } |
|----------------|---|

| | |
|------------------------------|---|
| Parameter Description | <i>portal-name</i> : Indicates the customized portal server name. |
| Command Mode | Global configuration mode |
| Usage Guide | eportalv2 indicates the default template of Ruijie Second-Generation Web Authentication. |

▾ Configuring the IP Address of the Portal Server

| | |
|------------------------------|---|
| Command | ip { <i>ip-address</i> <i>ipv6-address</i> } |
| Parameter Description | Indicates the IP address of the portal server. |
| Command Mode | Webauth template configuration mode |
| Usage Guide | N/A |

▾ Configuring the Webauth URL of the Portal Server

| | |
|------------------------------|---|
| Command | url { <i>url-string</i> } |
| Parameter Description | Indicates the Webauth URL of the portal server. |
| Command Mode | Webauth template configuration mode |
| Usage Guide | The URL starts with http:// or https:// . |

▾ Configuring the Format of the Webauth URL

| | |
|------------------------------|---|
| Command | fmt { <i>cmcc-ext1</i> <i>cmcc-ext2</i> <i>cmcc-mtx</i> <i>cmcc-normal</i> <i>ct-jc</i> <i>cucc</i> <i>ruijie</i> <i>custom</i> } |
| Parameter Description | Indicates the format of the Webauth URL. |
| Command Mode | Webauth template configuration mode |
| Usage Guide | <p>The cmcc-normal and cmcc-ext1 parameters in the fmt command support only IPv4. If IPv6 is used, the configuration of the portal server is invalid.</p> <p>The cmcc-ext2 is supported for Liaoning CMCC.</p> <p>When fmt is set to cmcc-mtx, the URL format of mobile AC vendors is supported.</p> <p>The ct-jc format is supported for China Telecom.</p> <p>The cucc format is supported for Shandong China Telecom.</p> <p>The custom format is defined by users.</p> |

▾ Specifying the Encapsulation Format of the Webauth URL

| | |
|------------------------------|---|
| Command | redirect { <i>http</i> <i>js</i> } |
| Parameter Description | Indicates the encapsulation format of redirected packets. |

| | |
|---------------------|--|
| Command Mode | Webauth template configuration mode |
| Usage Guide | For JavaScript-incapable Apps, you need to specify the HTTP encapsulation format to trigger redirection. |

▾ Configuring the Webauth Communication Key

| | |
|------------------------------|--|
| Command | web-auth portal key { <i>key-string</i> } |
| Parameter Description | <i>key-string</i> : Indicates the Webauth communication key used for the communication between the NAS and portal server. The key contains up to 255 characters. |
| Command Mode | Global configuration mode |
| Usage Guide | N/A |

▾ Enabling Ruijie Second-Generation Web Authentication on an Interface

| | |
|------------------------------|--|
| Command | web-auth enable { <i>eportalv2</i> <i>template-name</i> } |
| Parameter Description | Indicates a Webauth template. |
| Command Mode | Interface configuration mode |
| Usage Guide | N/A |

Configuration Example

▾ Configuring Ruijie Second-Generation Web Authentication

| | |
|--------------------------------|---|
| Scenario Figure 1-10 | <p>The diagram illustrates a network topology for Ruijie Second-Generation Web Authentication. A central Network Access Server (NAS) with IP address 192.168.197.95 is connected to four entities: the Internet (represented by a cloud), a Security Accounting Manager (SAM) server with IP address 192.168.197.80, an ePortal server with IP address 192.168.197.79, and a User with IP address 192.168.197.64. All connections are shown as bidirectional lines.</p> |
| Configuration Steps | <ul style="list-style-type: none"> ● Enable AAA on the NAS. ● Configure the RADIUS-server host and communication key on the NAS. ● Configure the default AAA method lists for Web authentication and accounting on the NAS. ● Configure the IP address of the portal server and the Webauth communication key (ruijie) used for communicating with the portal server on the NAS. ● Configure the Webauth URL on the NAS. ● Configure Ruijie Second-Generation Web Authentication in global configuration mode on the NAS. ● Enable Web authentication on ports GigabitEthernet 0/2 and GigabitEthernet 0/3 on the NAS. |

| | |
|---------------------|---|
| | <pre>Ruijie#configure Enter configuration commands, one per line. End with CNTL/Z. Ruijie(config)#aaa new-model</pre> |
| | <pre>Ruijie(config)#radius-server host 192.168.197.79 key ruijie</pre> |
| | <pre>Ruijie(config)#aaa authentication web-auth default group radius Ruijie(config)#aaa accounting network default start-stop group radius</pre> |
| | <pre>Ruijie(config)#web-auth template eportalv2 Ruijie(config.tmplt.eportalv2)#ip 192.168.197.79 Ruijie(config.tmplt.eportalv2)#exit Ruijie(config)#web-auth portal key ruijie</pre> |
| | <pre>Ruijie(config)# web-auth template eportalv2 Ruijie(config.tmplt.eportalv2)#url http://192.168.197.79:8080/eportal/index.jsp Ruijie(config.tmplt.eportalv2)#exit</pre> |
| | <pre>Ruijie(config)# interface range GigabitEthernet 0/2-3 Ruijie(config-if-range)# web-auth enable eportalv2 Ruijie(config-if-range)# exit</pre> |
| Verification | <ul style="list-style-type: none"> ● Check whether Web authentication is configured successfully. |
| | <pre>Ruijie(config)#show running-config ... aaa new-model aaa authentication web-auth default group radius aaa accounting network default start-stop group radius ... radius-server host 192.168.197.79 key ruijie ... web-auth template eportalv2 ip 192.168.197.79 url http://192.168.197.79:8080/eportal/index.jsp !</pre> |

| | |
|--|--|
| | <pre>web-auth portal key ruijie ... interface GigabitEthernet 0/2 web-auth enable eportalv2 ! interface GigabitEthernet 0/3 web-auth enable eportalv2</pre> |
| | <pre>Ruijie#show web-auth control Port Control Server Name Online User Count ----- ... GigabitEthernet 0/2 On eportalv2 0 GigabitEthernet 0/3 On eportalv2 0 ...</pre> |
| | <pre>Ruijie#show web-auth template Webauth Template Settings: ----- Name: eportalv2 Url: http://17.17.1.21:8080/eportal/index.jsp Ip: 17.17.1.21 BindMode: ip-mac-mode Type: v2 Port: 50100 State: Active Acctmlist: default Authmlist: default ...</pre> |

Common Errors

- The communication key between the portal server and NAS is configured incorrectly or only on the portal server or NAS, causing authentication errors.
- The communication parameters of the RADIUS server and NAS are set incorrectly, causing authentication errors.

- The portal server does not support the *CMCC WLAN Service Portal Specification*, causing compatibility failure.

1.4.3. Configuring Ruijie iPortal Web Authentication

Configuration Effect

Redirect unauthenticated clients to the Webauth URL to perform authentication. No external portal server is required.

Notes

- Some devices, such as AP110, do not have a built-in page suite. You need to import a page suite before use. For details about the page suite support on a product, see the corresponding product description.
- Ruijie iPortal Web Authentication is configured on EG devices in global configuration mode.
- To configure a customized page suite, the configuration must comply with the relevant specification.

Configuration Steps

↳ Enabling AAA

- (Mandatory) To enable Ruijie Second-Generation Web Authentication, you must enable AAA.
- The iPortal NAS is responsible for initiating authentication to the portal server through AAA in Ruijie iPortal Web authentication.

↳ Configuring the RADIUS-Server Host and Communication Key

- (Mandatory) To enable Ruijie iPortal Web Authentication, you must configure the RADIUS-server host.
- Clients' account information is stored on the RADIUS server. The NAS needs to connect to the RADIUS server to validate a client.

↳ Configuring an AAA Method List for Ruijie iPortal Web Authentication

- (Mandatory) To enable Ruijie iPortal Web Authentication, you must configure an AAA method list for Ruijie iPortal Web Authentication.
- An AAA authentication method list associates Web authentication requests with the RADIUS server. The NAS selects an authentication method and server based on the method list.

↳ Configuring an AAA Method List for Ruijie iPortal Web Accounting

- (Optional) Some servers require that authentication and accounting be enabled. Configure Web accounting based on the characteristics of the server in use.
- An AAA accounting method list associates an accounting method and server. In Web authentication, accounting is implemented to record client fees.

↳ Configuring the iPortal Webauth Template

- Mandatory.

- If any non-default authentication and accounting method lists are configured, you need to specify the name of a method list in template configuration mode; otherwise, the default method list is used.

↘ Enabling Ruijie iPortal Web Authentication Globally or on an Interface

- Mandatory.

Verification

- Check whether unauthenticated clients are redirected to the Webauth URL to perform authentication, and the Webauth URL displayed is that in the page suite.
- Check whether authenticated clients can access the Internet normally.

Related Commands

↘ Enabling AAA

| | |
|---------------------|---|
| Command | aaa new-model |
| Parameter | N/A |
| Description | |
| Command Mode | Global configuration mode |
| Usage Guide | You can configure the AAA authentication and accounting method lists only after AAA is enabled. |

↘ Configuring the RADIUS-Server Host and Communication Key

| | |
|------------------------------|--|
| Command | radius-server host { <i>ip-address</i> } [auth-port <i>port-number 1</i>] [acct-port <i>port-number 2</i>] key { <i>string</i> } |
| Parameter Description | <i>ip-address</i> : Indicates the IP address of the RADIUS-server host. <i>port-number1</i> : Indicates the authentication port. <i>port-number2</i> : Indicates the accounting port. <i>string</i> : Indicates the key string. |
| Command Mode | Global configuration mode |
| Usage Guide | By default, the authentication port number is 1812, and the accounting port number is 1813. |

↘ Configuring an AAA Method List for Ruijie iPortal Web Authentication

| | |
|------------------------------|---|
| Command | aaa authentication iportal { default <i>list-name</i> } <i>method1</i> [<i>method2...</i>] |
| Parameter Description | <i>list-name</i> : Creates a method list. <i>method1</i> : Indicates method 1. <i>method2</i> : Indicates method 2. |
| Command Mode | Global configuration mode |
| Usage Guide | The specified AAA method should exist in the AAA configuration. |

↘ Configuring an AAA Method List for Web Accounting

| | |
|---------------------|--|
| Command | aaa accounting network { default <i>list-name</i> } start-stop <i>method1</i> [<i>method2...</i>] |
| Parameter | <i>list-name</i> : Creates a method list. |
| Description | <i>method1</i> : Indicates method 1. <i>method2</i> : Indicates method 2. |
| Command Mode | Global configuration mode |
| Usage Guide | The specified AAA method should exist in the AAA configuration. |

↘ Configuring the iPortal Webauth Template

| | |
|---------------------|----------------------------------|
| Command | web-auth template iportal |
| Parameter | N/A |
| Description | |
| Command Mode | Global configuration mode |
| Usage Guide | N/A |

↘ Specifying the Pre-login Advertisement Mode

| | |
|---------------------|---|
| Command | login-popup { <i>url-string</i> } |
| Parameter | Indicates the advertisement URL. |
| Description | |
| Command Mode | Webauth template configuration mode |
| Usage Guide | The URL starts with http:// or https:// . |

↘ Specifying the Post-login Advertisement Mode

| | |
|---------------------|---|
| Command | online-popup { <i>url-string</i> } |
| Parameter | Indicates the advertisement URL. |
| Description | |
| Command Mode | Webauth template configuration mode |
| Usage Guide | The URL starts with http:// or https:// . |

↘ Customizing a Page Suite

| | |
|---------------------|--|
| Command | page-suit { <i>filename</i> } |
| Parameter | Indicates the file name of a page suite. |
| Description | |
| Command Mode | Webauth template configuration mode |
| Usage Guide | N/A |

↘ Configuring the iPortal Advertisement Interval

| | |
|---------------------|---------------------------------------|
| Command | time-interval {hour} |
| Parameter | Indicates the advertisement interval. |
| Description | |
| Command Mode | Webauth template configuration mode |
| Usage Guide | N/A |

▾ Enabling Ruijie iPortal Web Authentication on an Interface

| | |
|---------------------|---|
| Command | web-auth enable iportal |
| Parameter | Indicates the customized template name. |
| Description | |
| Command Mode | Interface configuration mode or global configuration mode |
| Usage Guide | N/A |

Configuration Example

▾ Configuring Ruijie iPortal Web Authentication

| | |
|----------------------------|--|
| Configuration Steps | <ul style="list-style-type: none"> ● Enable AAA on the NAS. ● Configure the RADIUS-server host and communication key on the NAS. ● Configure the default AAA authentication and accounting method lists on the NAS. ● Configure the global use of the iPortal server on the NAS. ● Enable Web authentication on ports GigabitEthernet 0/2 and GigabitEthernet 0/3 on the NAS. |
| | <pre>Ruijie#configure Enter configuration commands, one per line. End with CNTL/Z. Ruijie(config)#aaa new-model</pre> |
| | <pre>Ruijie(config)#radius-server host 192.168.197.79 key ruijie</pre> |
| | <pre>Ruijie(config)#aaa authentication iportal default group radius Ruijie(config)#aaa accounting network default start-stop group radius</pre> |
| | <pre>Ruijie(config)#web-auth template iportal</pre> |
| | <pre>Ruijie(config.tmplt.iportal)#exit</pre> |
| | <pre>Ruijie(config)# interface range GigabitEthernet 0/2-3 Ruijie(config-if-range)# web-auth enable iportal Ruijie(config-if-range)# exit</pre> |
| Verification | <ul style="list-style-type: none"> ● Check whether Ruijie iPortal Web Authentication is configured successfully. |

```

Ruijie(config)#show running-config

...

aaa new-model

aaa authentication web-auth default group radius

aaa accounting network default start-stop group radius

...

radius-server host 192.168.197.79 key ruijie

...

web-auth template iportal

!

...

interface GigabitEthernet 0/2

 web-auth enable iportal

!

interface GigabitEthernet 0/3

 web-auth enable iportal

```

```

Ruijie#show web-auth control

Port                Control  Server Name          Online User Count
-----
...

GigabitEthernet 0/2    On      iportal              0
GigabitEthernet 0/3    On      iportal              0
...

```

```

Ruijie#show web-auth template

Webauth Template Settings:

-----

Name:      iportal

Page-suit: default

BindMode:  ip-mac-mode

Type:      Intral Portal

Advertising: null

```

```
Advertising mode : online-popup
Acctmlist: default
Authmlist: default
...
```

Common Errors

- The preparation of a page suite does not comply with the relevant specification.
- A page suite is specified, but is not downloaded to the flash memory or the specified directory.

1.4.4. Configuring WiFiDog Authentication

Configuration Effect

Redirect unauthenticated clients to the Webauth URL to perform authentication.

Notes

N/A

Configuration Steps

▾ Configuring the Portal Server

- (Mandatory) To enable Web authentication, you must configure and apply the portal server.
- When the NAS finds an unauthenticated client attempting to access network resources through HTTP, it redirects the client's access requests to the specified Webauth URL, where the client can initiate authentication to the portal server. The IP address of the portal server is configured as a network resource which clients can access without authentication. Unauthenticated clients can directly access this IP address through HTTP.

▾ Configuring the IP Address of the NAS

- Mandatory.
- By default, the IP address of the NAS is not configured.
- Ensure that the configured IP address is accessible by clients.

▾ Enabling Ruijie iPortal Web Authentication on an Interface

- Mandatory.
- When Ruijie iPortal Web Authentication is enabled in interface configuration mode, Web authentication is not enabled on any port by default. The users connecting to the port do not need to perform Web authentication.

Verification

- Check whether unauthenticated clients are required to perform authentication.

- Check whether authenticated clients can access the Internet normally.

Related Commands

▾ Configuring a WiFiDog Webauth Template

| | |
|------------------------------|--|
| Command | web-auth template wifidog |
| Parameter Description | N/A |
| Command Mode | Global configuration mode |
| Usage Guide | wifidog means the default WiFiDog Webauth template. |

▾ Configuring the IP Address of the Portal Server

| | |
|------------------------------|--|
| Command | ip { ip-address } |
| Parameter Description | Indicates the IP address of the portal server. |
| Command Mode | Webauth template configuration mode |
| Usage Guide | N/A |

▾ Configuring the Webauth URL of the Portal Server

| | |
|------------------------------|---|
| Command | url { url-string } |
| Parameter Description | Indicates the Webauth URL of the portal server. |
| Command Mode | Webauth template configuration mode |
| Usage Guide | The URL starts with http:// . |

▾ Configuring the IP Address of the NAS

| | |
|------------------------------|---|
| Command | nas-ip { ip-address } |
| Parameter Description | Indicates the IP address of the NAS. |
| Command Mode | Webauth template configuration mode |
| Usage Guide | Ensure that the configured IP address is accessible by clients. |

▾ Enabling WiFiDog Web Authentication on an Interface

| | |
|------------------------------|------------------------------|
| Command | web-auth enable |
| Parameter Description | N/A |
| Command | Interface configuration mode |

| | |
|--------------------|-----|
| Mode | |
| Usage Guide | N/A |

Configuration Example

Configuring WiFiDog Web Authentication

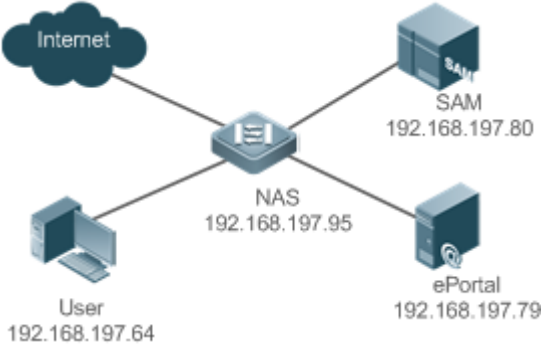
| | |
|--|---|
| <p>Scenario Figure 1-11</p> |  <p>The diagram illustrates a network topology for WiFiDog web authentication. A central Network Access Server (NAS) with IP address 192.168.197.95 is connected to four components: the Internet, a Security Authentication Manager (SAM) with IP 192.168.197.80, an ePortal with IP 192.168.197.79, and a User with IP 192.168.197.64.</p> |
| <p>Configuration Steps</p> | <ul style="list-style-type: none"> ● Configure the IP address of the portal server on the NAS. ● Configure the Webauth URL on the NAS. ● Configure the IP address used for external communication on the NAS. ● Enable WiFiDog Web authentication for WLAN10 on the NAS. |
| | <pre>Ruijie# config Enter configuration commands, one per line. End with CNTL/Z. Ruijie(config)#web-auth template wifidog Ruijie(config.tmpl.wifidog)#ip 192.168.197.79</pre> |
| | <pre>Ruijie(config.tmpl.wifidog)#url http://192.168.197.79/auth/wifidogAuth Ruijie(config.tmpl.wifidog)#nas-ip 192.168.197.95 Ruijie(config.tmpl.wifidog)#exit</pre> |
| | <pre>Ruijie(config)# wlansec 10</pre> |
| | <pre>Ruijie(config-wlansec)#web-auth portal wifidog Ruijie(config-if-range)# webauth Ruijie(config-if-range)# exit</pre> |
| <p>Verification</p> | <ul style="list-style-type: none"> ● Check whether WiFiDog Web authentication is configured successfully. |
| | <pre>Ruijie(config)#show running-config ...</pre> |

| |
|--|
| <pre>web-auth template wifidog ip 192.168.197.79 nas-ip 192.168.197.95 url http://192.168.197.79/auth/wifidogAuth ... wlansec 10 web-auth portal wifidog webauth</pre> |
| <pre>Ruijie#show web-auth control Port Control Server Name Online User Count ----- wlansec 10 On wifidog 0 ...</pre> |
| <pre>Ruijie#show web-auth template Webauth Template Settings: ----- Name: wifidog Type: wifidog Ip: 192.168.197.79 Url: http://192.168.197.79/auth/wifidogAuth NasIp: 192.168.197.95</pre> |

Common Errors

- The IP address of the NAS is not configured, causing a redirection failure.

1.4.5. Configuring MAC Address-Based SMS Authentication

Configuration Effect

Allow unauthenticated clients connected to WLAN to access network resources. When a user uses up the traffic during the specified time period, the NAS initiates a MAC address binding query to the bound portal server. If the user is bound with a MAC address, the portal server initiates an authentication request. If the STA is not bound with a MAC address, the STA needs to perform authentication on the portal server before accessing the Internet.

Notes

- MAC address-based SMS authentication is supported only on wireless devices.
- The configured URL of the portal server must adopt the **cmcc-ext1** format.

Configuration Steps

↳ Enabling AAA

- (Mandatory) To enable Ruijie Second-Generation Web Authentication, you must enable AAA.
- The NAS is responsible for initiating authentication to the portal server through AAA in Ruijie Second-Generation Web Authentication.

| | |
|---------------------|---|
| Command | aaa new-model |
| Parameter | N/A |
| Description | |
| Command Mode | Global configuration mode |
| Usage Guide | You can configure the AAA authentication and accounting method lists only after AAA is enabled. |

↳ Configuring the RADIUS-Server Host and Communication Key

- (Mandatory) To enable MAC address-based SMS authentication, you must configure the RADIUS server.
- Clients' account information is stored on the RADIUS server. The NAS needs to connect to the RADIUS server to validate a client.

| | |
|------------------------------|--|
| Command | radius-server host { <i>ip-address</i> } [auth-port <i>port-number 1</i>] [acct-port <i>port-number 2</i>] key { <i>string</i> } |
| Parameter Description | <i>ip-address</i> : Indicates the IP address of the RADIUS server host. <i>port-number1</i> : Indicates the authentication port. <i>port-number2</i> : Indicates the accounting port. <i>string</i> : Indicates the key string. |
| Command Mode | Global configuration mode |
| Usage Guide | By default, the authentication port number is 1812, and the accounting port number is 1813. |

↳ Configuring an AAA Method List for Web Authentication

- (Mandatory) To enable Ruijie Second-Generation Web Authentication, you must configure an AAA authentication method list on the AAA module.
- A Web authentication method list associates Web authentication requests with the RADIUS server. The NAS selects an authentication method and server based on the Web authentication method list.

| | |
|------------------------------|---|
| Command | aaa authentication web-auth { default <i>list-name</i> } <i>method1</i> [<i>method2...</i>] |
| Parameter Description | <i>list-name</i> : Indicates a method list name. <i>method1</i> : Indicates method 1. |

| | |
|---------------------|--|
| | <i>method2</i> : Indicates method 2. |
| Command Mode | Global configuration mode |
| Usage Guide | Ruijie Second-Generation Web Authentication adopts the RADIUS authentication method. |

▾ Configuring an AAA Method List for Web Accounting

- (Mandatory) To enable Ruijie Second-Generation Web Authentication, you must configure a network accounting method on the AAA module.
- A network accounting method is used to associate an accounting method and server. In Web authentication, accounting is implemented to record user information or fees.

| | |
|------------------------------|--|
| Command | aaa accounting network { default list-name } start-stop method1 [method2...] |
| Parameter Description | <i>list-name</i> : Indicates a method list name. <i>method1</i> : Indicates method 1. <i>method2</i> : Indicates method 2. |
| Command Mode | Global configuration mode |
| Usage Guide | Ruijie Second-Generation Web Authentication adopts the RADIUS accounting method. |

▾ Configuring the Second-Generation Webauth Template

- (Mandatory) To enable Ruijie Second-Generation Web Authentication, you must configure and apply the portal server.
- When the NAS or convergence device finds an unauthenticated client attempting to access network resources through HTTP, it redirects the access request to the specified Webauth URL, where the client can initiate authentication to the portal server. If the IP address of the portal server is configured as a free network resource, unauthenticated clients can directly visit this IP address through HTTP.

| | |
|------------------------------|---|
| Command | web-auth template { eportalv2 portal-name v2} |
| Parameter Description | Indicates the customized portal server name. |
| Command Mode | Global configuration mode |
| Usage Guide | eportalv2 indicates the default template of Ruijie Second-Generation Web Authentication. |

▾ Configuring the IP Address of the Portal Server

| | |
|------------------------------|--|
| Command | ip { ip-address ipv6-address } |
| Parameter Description | Indicates the IP address of the portal server. |
| Command Mode | Webauth template configuration mode |
| Usage Guide | N/A |

▾ Configuring the Webauth URL of the Portal Server

| | |
|------------------------------|---|
| Command | url { <i>url-string</i> } |
| Parameter Description | Indicates the Webauth URL of the portal server. |
| Command Mode | Webauth template configuration mode |
| Usage Guide | The URL starts with http:// or https:// . |

📌 Configuring the Format of the Webauth URL

| | |
|------------------------------|--|
| Command | fmt { cmcc-ext1 cmcc-normal ruijie } |
| Parameter Description | Indicates the format of the Webauth URL. |
| Command Mode | Webauth template configuration mode |
| Usage Guide | fmt must be set to cmcc-ext1 . |

📌 Configuring the Webauth Communication Key

- (Mandatory) To enable Ruijie Second-Generation Web Authentication, you must configure the key used for the communication between the NAS or convergence device and portal server.
- When the NAS finds an unauthenticated client attempting to access network resources, it redirects the client to the specified Webauth URL, where the client can initiate authentication to the portal server. During the authentication process, the communication key is used to encrypt some data exchanged between the NAS and portal server to improve security.

| | |
|------------------------------|--|
| Command | web-auth portal key { <i>key-string</i> } |
| Parameter Description | <i>key-string</i> : Indicates the Webauth communication key used for the communication between the NAS and portal server. The key contains up to 255 characters. |
| Command Mode | Global configuration mode |
| Usage Guide | N/A |

📌 Configuring the Detection Interval and Traffic Threshold for MAC Address-based SMS Authentication

- After an STA is associated with the WLAN enabled with MAC address-based SMS authentication, a free data quota is allocated to the STA. When the STA uses up the traffic allowed during the specified time period, a MAC address binding status query is triggered.

| | |
|------------------------------|--|
| Command | web-auth sms-flow interval <i>interval</i> threshold <i>flows</i> |
| Parameter Description | <i>interval</i> : Indicates the detection interval, in the unit of minutes. <i>flows</i> : Indicates the flow threshold, in the unit of KB. |
| Command Mode | Global configuration mode |
| Usage Guide | N/A |

↘ Configuring the Portal Server Bound for MAC Address-based SMS Authentication

- Mandatory.

| | |
|------------------------------|---|
| Command | web-auth bind-portal <i>string</i> [type { <i>local-spec</i> <i>group-spec</i> }] |
| Parameter Description | <i>string</i> : Indicates a Webauth template. |
| Command Mode | WLAN security configuration mode |
| Usage Guide | N/A |

↘ Setting the winterface Field in the Redirection URL

- China Mobile's MAC address-based specification requires that the redirection URL carry the **winterface** field, which must be configurable based on a WLAN.

| | |
|------------------------------|--|
| Command | web-auth winterface <i>string</i> |
| Parameter Description | <i>string</i> : Indicates winterface field. |
| Command Mode | WLAN security configuration mode |
| Usage Guide | N/A |

↘ Setting the AC IP Field in the Redirection URL

- China Mobile's MAC address-based specification requires that the redirection URL carry the **AC IP** field. Because an AC may have multiple IP addresses, a configuration command is provided to configure an IPv4 address on the specified WLAN, and the IPv4 address specifies the value of the **AC IP** field in the redirection URL.

| | |
|------------------------------|---|
| Command | web-auth wlan-ac-ip <i>ipv4</i> |
| Parameter Description | <i>ipv4</i> : Indicates the AC IP field. |
| Command Mode | WLAN security configuration mode |
| Usage Guide | N/A |

Verification

- Check that unauthenticated clients can access the Internet before the traffic threshold is reached.
- Check that authentication is triggered when the traffic threshold is reached.

Configuration Example

↘ Configuring MAC Address-Based SMS Authentication

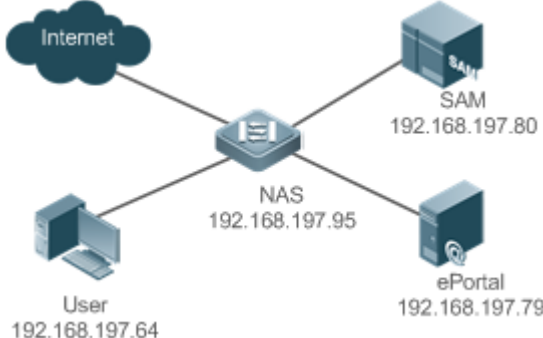
| | |
|---|---|
| <p>Scenario Figure 1-12</p> |  <pre> graph TD Internet((Internet)) --- NAS[NAS 192.168.197.95] SAM[SAM 192.168.197.80] --- NAS User[User 192.168.197.64] --- NAS ePortal[ePortal 192.168.197.79] --- NAS </pre> |
| <p>Configuration Steps</p> | <ul style="list-style-type: none"> ● Enable AAA on the NAS. ● Configure the RADIUS-server host and communication key on the NAS. ● Configure the default AAA method lists for Web authentication and accounting on the NAS. ● Configure the IP address of the portal server and the Webauth communication key (ruijie) used for communicating with the portal server on the NAS. ● Configure the Webauth URL on the NAS. ● Configure the detection interval and traffic threshold for MAC address-based SMS authentication, and set the winterface and AC IP fields on the NAS. ● Enable MAC address-based SMS authentication for WLANSEC1 on the NAS. |
| | <pre>Ruijie#configure Enter configuration commands, one per line. End with CNTL/Z. Ruijie(config)#aaa new-model</pre> |
| | <pre>Ruijie(config)#radius-server host 192.168.197.79 key ruijie</pre> |
| | <pre>Ruijie(config)#aaa authentication web-auth default group radius Ruijie(config)#aaa accounting network default start-stop group radius</pre> |
| | <pre>Ruijie(config)#web-auth template eportalv2 Ruijie(config.tmpl.eportalv2)#ip 192.168.197.79 Ruijie(config.tmpl.eportalv2)#exit Ruijie(config)#web-auth portal key ruijie</pre> |
| | <pre>Ruijie(config)# web-auth template eportalv2 Ruijie(config.tmpl.eportalv2)#url http://192.168.197.79:8080/eportal/index.jsp Ruijie(config.tmpl.eportalv2)#fmt cmcc-ext1 Ruijie(config.tmpl.eportalv2)#exit</pre> |
| | <pre>Ruijie(config)# web-auth sms-flow interval 5 threshold 10</pre> |

| | |
|---------------------|---|
| | <pre>Ruijie(config)# wlansec 1 Ruijie(config-wlansec)# web-auth bind-portal eportalv2 Ruijie(config-if-range)# exit</pre> |
| | |
| Verification | <ul style="list-style-type: none"> ● Check whether Web authentication is configured successfully. |
| | <pre>Ruijie(config)#show running-config ... aaa new-model aaa authentication web-auth default group radius aaa accounting network default start-stop group radius ... radius-server host 192.168.197.79 key ruijie ... web-auth template eportalv2 ip 192.168.197.79 url http://192.168.197.79:8080/eportal/index.jsp fmt cmcc-ext1 ! web-auth portal key ruijie web-auth sms-flow interval 5 threshold 10 ... wlansec 1 web-auth bind-portal eportalv2 ! interface GigabitEthernet 0/3 web-auth enable eportalv2</pre> |

Common Errors

- The communication key between the portal server and NAS is configured incorrectly or only on the portal server or NAS, causing authentication errors.
- The communication parameters of the RADIUS server and NAS are set incorrectly, causing authentication errors.
- The portal server does not support the CMCC WLAN Service Portal Specification, causing compatibility failure.

1.4.6. Configuring WeChat Web Authentication

Configuration Effect

- Redirect unauthenticated mobile phone users with WLAN association to a WeChat-based one-click Wi-Fi connection page displayed on the mobile phone browser. A user can tap a link on the page to wake up the WeChat client and use it to perform Wi-Fi connection authentication.
- Allow unauthenticated mobile phone users to scan a QR code to perform Wi-Fi connection authentication through WeChat.
- Redirect unauthenticated PC users with WLAN association to a WeChat-based one-click Wi-Fi connection page displayed on the PC browser. A user can scan a QR code on the page by using the mobile phone associated with the same WLAN as the PC to enable the PC to perform authentication to access the Internet.

Notes

- WeChat Web authentication is supported only on wireless devices.

Configuration Steps

↳ Creating a Wechat Webauth Template

- (Mandatory) To enable WeChat Web authentication, you must create a template.

| | |
|------------------------------|--|
| Command | web-auth template {wechat (<i>portal-name</i> wechat)} |
| Parameter Description | Indicates the name of the customized template for WeChat Web authentication |
| Command Mode | Global configuration mode |
| Usage Guide | wechat is the name of the default template of WeChat-based Wi-Fi connection authentication. |

↳ Configuring the IP Address of the Portal Server

- (Mandatory) To enable WeChat Web authentication, you must configure the IP address of the portal server.

| | |
|------------------------------|--|
| Command | ip <i>ip-address</i> |
| Parameter Description | Indicates the IP address of the portal server. |
| Command Mode | Webauth template configuration mode |
| Usage Guide | N/A |

↳ Configuring the WeChat Webauth URL

- (Mandatory) To enable WeChat Web authentication, you must configure the WeChat Webauth URL address of the portal server.

| | |
|----------------|--|
| Command | service-url { <i>url-string</i> } |
|----------------|--|

| | |
|------------------------------|---|
| Parameter Description | Indicates the WeChat Webauth URL. |
| Command Mode | Webauth template configuration mode |
| Usage Guide | Configure only the domain name, which must not start with http:// or https:// . |

↘ Configuring the Authentication Page Address for the Portal Server

- The function is optional for devices of version 11.1(5)B9 and the default configuration can be used.

| | |
|------------------------------|---|
| Command | url { <i>url-string</i> } |
| Parameter Description | url : Indicates the URL address of the server. |
| Command Mode | Template configuration mode of web authentication |
| Usage Guide | The authentication page address starts with http:// or https:// . |

↘ Configuring the Webauth Communication Key

- (Mandatory) To enable WeChat Web authentication, you must configure the communication key of the portal server.

| | |
|------------------------------|--|
| Command | key <i>key-string</i> |
| Parameter Description | <i>key-string</i> : Indicates the communication key of the portal server. You need to configure a key used for the communication between the NAS and authentication server. The key contains up to 255 characters. |
| Command Mode | Webauth template configuration mode |
| Usage Guide | Ensure that the communication keys configured on the portal server and the NAS are the same; otherwise, interworking will fail. |

↘ Configuring the WeChat Webauth Version

- (Optional) By default, V1.0 is used.

| | |
|------------------------------|---|
| Command | version { 1.0 16wifi 3.0 } |
| Parameter Description | version : Indicates the version of WeChat Web authentication. By default, Ruijie V1.0 is used. Devices of version 11.1(5)B9 use Ruijie WeChat Web authentication 3.0 by default. |
| Command Mode | Webauth template configuration mode |
| Usage Guide | To use the 16wifi version, run the http redirect port 4990 command to enable packet interception on TCP port 4990. |

↘ Configuring PC Authentication Exemption

- (Optional) Authentication exemption allows the STAs that are identified as PC or Other to access the Internet without performing WeChat-based Wi-Fi connection authentication.

| | |
|----------------|---------------------|
| Command | free-auth pc |
|----------------|---------------------|

| | |
|------------------------------|-------------------------------------|
| Parameter Description | |
| Command Mode | Webauth template configuration mode |
| Usage Guide | N/A |

▾ Enabling the Smart WeChat Web Authentication

- Optional.

| | |
|------------------------------|---|
| Command | web-auth sta-perception enable |
| Parameter Description | |
| Command Mode | Global configuration mode |
| Usage Guide | Enable the smart authentication based on customer's requirements. Run the ip dhcp snooping command before the smart authentication takes effect. |

▾ Enabling the Single Escape Function

- (Optional)After the escape function is enabled, if an STA does not initiate a login authorization request after the specified time has elapsed, the server is considered to be faulty and the STA is permitted to escape the authentication and access the Internet.

| | |
|------------------------------|--|
| Command | escape interval seconds online-time minutes |
| Parameter Description | <i>seconds</i> : Indicates the escape interval in the unit of seconds. The recommended value is 5s. <i>minutes</i> : Indicates the maximum online time for escape users in the unit of minutes. When it is set to 0 , the user can access the Internet without time limit. |
| Command Mode | Webauth template configuration mode |
| Usage Guide | N/A |

▾ Enabling the Collective Escape Function

- (Optional) After the function is enabled, the device starts counting single escape users. If the number of single escape users reaches the threshold within a certain interval, the device starts collective escape and all users who gain access later are permitted to pass without authentication.
- In WLANSEC configuration mode, this function is supported in the version 11.1(5)B23. Configuration in WLANSEC configuration mode takes precedence. If this feature is not configured in WLANSEC configuration mode, then configuration in global configuration mode takes effect.
- To cancel collective escape, run the **web-auth wechat-escape recover** command in global configuration mode to restore the single escape state.

| | |
|------------------|--|
| Command | web-auth wechat-escape interval minutes times count |
| Parameter | <i>minutes</i> : Indicates timer interval for judging collective escape. The unit is minutes and the default value is 60 |

| | |
|---------------------|---|
| Description | minutes. <i>count</i> . Indicates the user quantity threshold. The default value is 5. |
| Command Mode | Global configuration mode |
| Usage Guide | In WLANSEC configuration mode, this function is supported in the version 11.1(5)B23. |

↘ Configuring Server Detection

- (Optional) After the function is configured, the device detects the server. If it fails to receive the server response or the response is unavailable within a certain interval and the collective escape function is configured on the device, all users who gain access later are permitted to pass without authentication.
- To cancel server detection, run the **no web-auth wechat-check** command in global configuration mode.

| | |
|------------------------------|--|
| Command | web-auth wechat-check interval <i>minutest</i> |
| Parameter Description | <i>minutes</i> : Indicates the timer interval for server detection. The unit is minutes and there is no default value. |
| Command Mode | Global configuration mode |
| Usage Guide | N/A |

↘ Configuring the Temporary Permit Function

- (Optional) The temporary permit function permits the packets sent by STAs to pass through during the authentication process. (The packets exchanged with the MCP server and Tencent server are permitted to pass through, whereas blacklist requests, login authorization requests, forced follow-up requests, and other requests are intercepted for processing.)

| | |
|------------------------------|---|
| Command | temporary-permit <i>seconds</i> |
| Parameter Description | <i>seconds</i> : Indicates the duration of temporary permit in the unit of seconds. The recommended value ranges from 30s to 60s. |
| Command Mode | Webauth template configuration mode |
| Usage Guide | N/A |

↘ Configuring the Smart IP Address Check

- (Optional) After smart IP address check is configured, the STAs that fail to obtain IP addresses after the specified time has elapsed are forced offline.

| | |
|------------------------------|--|
| Command | web-auth valid-ip-acct[timeout <i>seconds</i>] |
| Parameter Description | <i>seconds</i> : Indicates the time during which STAs can attempt to obtain IP addresses in the unit of seconds. The default value is 30s. |
| Command Mode | Global configuration mode |
| Usage Guide | N/A |

Verification

- Check whether unauthenticated clients are required to perform authentication.
- Check whether authenticated clients can access the Internet normally.

Configuration Example

Configuring WeChat Web Authentication

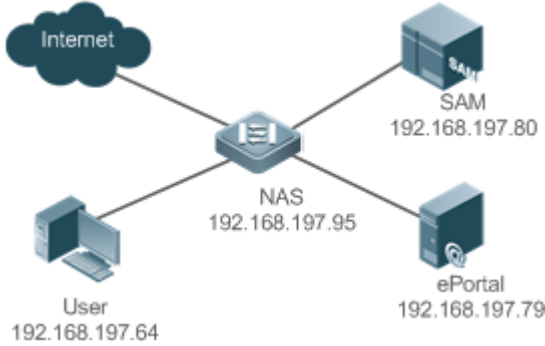
| | |
|--|---|
| <p>Scenario Figure 1-13</p> |  |
| <p>Configuration Steps</p> | <ul style="list-style-type: none"> ● Configure the IP address 192.168.58.110 of the domain name server on the NAS. ● Configure the WeChat Webauth template on the NAS. ● Configure the IP address and Webauth URL on the NAS. ● Configure the communication key (ruijie) used for communicating with the portal server on the NAS. ● Configure the IP address used for external communication on the NAS. ● Configure the WeChat Webauth version as 1.0 on the NAS. ● Apply the template to WLANSEC1 and enable WeChat Web authentication. |
| | <pre>Ruijie#configure Enter configuration commands, one per line. End with CNTL/Z. Ruijie(config)#ip name-server 192.168.58.110</pre> |
| | <pre>Ruijie(config)#web-auth template wechat</pre> |
| | <pre>Ruijie(config.tmpl.wechat)#ip 192.168.197.79 Ruijie(config.tmpl.wechat)#service-url wmc.ruijie.com.cn</pre> |
| | <pre>Ruijie(config.tmpl.wechat)#key ruijie</pre> |
| | <pre>Ruijie(config.tmpl.wechat)#nas-ip 192.168.197.104</pre> |
| | <pre>Ruijie(config.tmpl.wechat)#version 1.0 Ruijie(config.tmpl.wechat)#exit</pre> |

| | |
|---------------------|--|
| | <pre>Ruijie(config)# wlansec 1 Ruijie(config-wlansec)# web-auth portal wechat Ruijie(config-wlansec)# webauth</pre> |
| | |
| Verification | Check whether Web authentication is configured successfully. |
| | <pre>Ruijie(config)#show running-config ... ip name-server 192.168.58.110 ... web-auth template wechat ip 192.168.197.79 service-url wmc.ruijie.com.cn http://192.168.197.79:8080/eportal/index.jsp key ruijie nas-ip 192.168.197.104 !... wlansec 1 web-auth portal wechat webauth !</pre> |

Common Errors

- The key used for the communication between the portal server and NAS is configured incorrectly, or encryption is configured only on the portal server or NAS, causing abnormal authentication.
- The IP address of the NAS is configured as a straight-through address, and authentication packets cannot be received, causing an authentication failure.
- The IP address of the domain name server is not configured, causing a whitelist resolution failure. The IP address of the WeChat server is not permitted to pass.
- The ip dhcp snooping, ip dhcp snooping trust, and web-auth sta-perception enable commands are not executed when smart authentication is enabled, causing a failure of the smart authentication during second-time authentication.

1.4.7. Specifying an Authentication Method List

Configuration Effect

- The portal server sends an authentication request to the NAS when a user submits authentication information. The NAS resolves the authentication server information and other information based on the configured authentication method list name before initiating authentication.
- The NAS selects the authentication server based on the specified authentication method list.

Notes

- Before you configure an authentication method list name, ensure that the authentication methods in the list have been configured on the AAA module. The command used to configure authentication methods on the AAA module is **aaa authentication web-auth** { *default* | *list-name* }*method1* [*method2...*].
- Different authentication methods for IPv4 authentication and IPv6 authentication are not supported.

Configuration Steps

- Optional.
- The default authentication method is used if no authentication method list is configured. Run the **authentication** { *mlist-name* } command to configure an authentication method list name when the authentication method list name on the AAA module needs to be modified or multiple method lists exist.

Verification

- Configure two authentication method lists on the AAA module. Apply list 1 to server 1 and list 2 to server 2.
- Create user a and configured a password for the user on server 1. Create user b on server 2.
- Configure the use of list 1.
- Perform authentication as user b and check that authentication fails.
- Perform authentication as user a and check that authentication is successful.

Related Commands

↘ Specifying an Authentication Method List

| | |
|------------------------------|---|
| Command | authentication { <i>mlist-name</i> } |
| Parameter Description | Indicates a method list name. |
| Command Mode | Webauth template configuration mode |
| Usage Guide | Ensure that the configured authentication method list name is consistent with that on the AAA module. |

Configuration Example

↘ Specifying an Authentication Method List

| | |
|----------------------------|--|
| Configuration Steps | <ul style="list-style-type: none"> Specify the authentication method list mlist1. |
| | <pre>Ruijie(config.tmpl.t.portal)#authentication mlist1</pre> |
| Verification | <ul style="list-style-type: none"> Check whether the configuration is successful. |
| | <pre>Ruijie#show web-auth template Webauth Template Settings: ----- Name: eportalv2 Url: http://17.17.1.21:8080/eportal/index.jsp Ip: 17.17.1.21 BindMode: ip-only-mode Type: v2 Port: 50100 State: Active Acctmlist: default Authmlist: mlist1</pre> |

1.4.8. Specifying an Accounting Method List

Configuration Effect

- The NAS sends an accounting request when a user passes authentication. The recipient of the request depends on the configuration of the accounting method list and is usually the portal server.
- Specify an accounting method list for the NAS to perform accounting.

Notes

- Ensure that the accounting method list has been configured on the AAA module. The command used to configure accounting methods on the AAA module is **aaa accounting network {default | list-name }start-stop method1 [method2...]**.
- Different accounting methods for IPv4 authentication and IPv6 authentication are not supported.

Configuration Steps

- Optional.
- The default accounting method is used if no accounting method list is configured. Run the **accounting {mlist-name }** command to configure an accounting method list name when the accounting method list name on the AAA module needs to be modified or multiple method list names exist.

Verification

- Configure two accounting method lists on the AAA module. Apply list 1 to server 1 and list 2 to server 2.
- Configure the use of list 1.
- Use a valid account to perform authentication to access the Internet.
- View user accounting information on server1 and server2. Check that the user accounting information exists only on server1.

Related Commands

▾ Specifying an Accounting Method List

| | |
|------------------------------|---|
| Command | accounting { <i>mlist-name</i> } |
| Parameter Description | Indicates a method list name. |
| Command Mode | Webauth template configuration mode |
| Usage Guide | Ensure that the configured accounting method list name is consistent with that on the AAA module. |

Configuration Example

▾ Specifying an Accounting Method List

| | |
|----------------------------|---|
| Configuration Steps | <ul style="list-style-type: none"> ● Specify the accounting method list mlist1. <pre>Ruijie(config.tmplt.eportalv2)#accounting mlist1</pre> |
| Verification | <ul style="list-style-type: none"> ● Check whether the configuration is successful. <pre>Ruijie#show web-auth template Webauth Template Settings: ----- Name: eportalv2 Url: http://17.17.1.21:8080/eportal/index.jsp Ip: 17.17.1.21 BindMode: ip-mac-mode Type: v2 Port: 50100 State: Active Acctmlist: mlist1</pre> |

| | |
|----------------------------|---|
| Configuration Steps | <ul style="list-style-type: none"> Specify the accounting method list mlist1. |
| | <code>Ruijie(config.tmlt.eportalv2)#accounting mlist1</code> |
| Verification | <ul style="list-style-type: none"> Check whether the configuration is successful. |
| | <code>Authmlist: mlist1</code> |

1.4.9. Configuring the Communication Port of the Portal Server

Configuration Effect

- When the NAS detects that a user logs out, it notifies the portal server. The NAS interacts with the portal server through the portal specification, which specifies the port number used to listen to and send/receive packets.
- When the listening port of the portal server is changed, the communication port of the portal server must be modified on the NAS to enable the NAS to interact with the portal server.
- In Ruijie iPortal Web Authentication, this function is used to configure the HTTP listening port of the NAS. The default port number is 8081.

Notes

- The configured port number must be consistent with the port actually used by the portal server.
- This function is applicable to Ruijie Second-Generation Web Authentication and iPortal Web Authentication. The two authentication schemes use different default port numbers. In Ruijie Second-Generation Web Authentication, the configured port number is used for the interaction between the NAS and portal server through the portal specification. In Ruijie iPortal Web Authentication, the configured port number is used for packet listening on the NAS.

Configuration Steps

- Optional.
- Run the **port** *port-num* command to maintain port configuration consistency when the portal server does not use the default port number or the listening port of the NAS conflicts with other port and needs to be adjusted.

Verification

- Configure Ruijie Second-Generation Web Authentication.
- Change the listening port of the server to 10000.
- Run the **port** *port-num* command to configure the port number 10000.
- Simulate the scenario where a user performs authentication to access the Internet.
- Force the user offline on the NAS, refresh the online page, and check that a user logout notification is displayed.

Related Commands

➤ **Configuring the Communication Port of the Portal Server**

| | |
|---------------------|--|
| Command | <code>port port-num</code> |
| Parameter | <i>port-num</i> : Indicates the port number. |
| Description | |
| Command Mode | Webauth template configuration mode |
| Usage Guide | N/A |

Configuration Example

➤ **Configuring the Communication Port of the Portal Server**

| | |
|----------------------------|---|
| Configuration Steps | <ul style="list-style-type: none"> Configure the communication port of the portal server as port 10000. |
| | <pre>Ruijie(config.tmlt.eportalv2)#port 10000</pre> |
| Verification | <ul style="list-style-type: none"> Check whether the configuration is successful. |
| | <pre>Ruijie#show web-auth template Webauth Template Settings: ----- Name: eportalv2 Url: http://17.17.1.21:8080/eportal/index.jsp Ip: 17.17.1.21 BindMode: ip-only-mode Type: v2 Port: 10000 Acctmlist: Authmlist:</pre> |

1.4.10. Specifying the Webauth Binding Mode

Configuration Effect

- When a user goes online, the user's entry needs to be written to a forwarding rule. The forwarding rule mapping method can be modified by specifying different binding modes, which further affects the Internet access rules applied to users. In IP-only mode, all the packets carrying the specified IP address are permitted to pass, and the STAs who send the packets can access the Internet. In IP+MAC mode, only the packets carrying both the specified IP address and MAC address are permitted to pass, and the STAs who send the packets can access the Internet.

Notes

- In Layer-3 authentication, the MAC addresses visible to the NAS are the gateway addresses of STAs. Because these MAC addresses are not accurate, the IP-only mode should be used.

Configuration Steps

- (Optional) The default Webauth binding mode is IP+MAC.
- Determine a binding mode based on the accuracy of user information obtained by the NAS. When the IP and MAC addresses of STAs are accurate (in L2 authentication, for example), IP+MAC is recommended. When the IP and MAC addresses are not accurate, select IP-only.

Verification

- Change the binding mode to IP-only.
- Simulate the scenario where a user performs authentication to access the Internet.
- Modify the MAC address of the user, or use a client with the same IP address but a different MAC address to access the Internet.
- Check that the user accesses the Internet normally.

Related Commands

▾ Specifying the Webauth Binding Mode

| | |
|---------------------|--|
| Command | bindmode {ip-mac-mode ip-only-mode} |
| Parameter | ip-mac-mode: Indicates IP-MAC binding mode. |
| Description | ip-only-mode: Indicates IP-only binding mode. |
| Command Mode | Webauth template configuration mode |
| Usage Guide | N/A |

Configuration Example

▾ Specifying the Webauth Binding Mode

| | |
|----------------------------|--|
| Configuration Steps | <ul style="list-style-type: none"> ● Set the binding mode to IP-only. <pre>Ruijie(config.tmpl.eportalv2)#bindmode ip-only-mode</pre> |
| Verification | <ul style="list-style-type: none"> ● Check whether the configuration is successful. <pre>Ruijie#show web-auth template</pre> <pre>Webauth Template Settings:</pre> <pre>-----</pre> |

| | |
|----------------------------|--|
| Configuration Steps | <ul style="list-style-type: none"> Set the binding mode to IP-only. |
| | <code>Ruijie(config. tmplt. eportalv2)#bindmode ip-only-mode</code> |
| Verification | <ul style="list-style-type: none"> Check whether the configuration is successful. |
| | <pre>Name: eportalv2 Url: http://17.17.1.21:8080/eportal/index.jsp Ip: 17.17.1.21 BindMode: ip-only-mode Type: v2 Port: 10000 Acctmlist: Authmlist:</pre> |

1.4.11. Customizing a Page Suite

Configuration Effect

- Configure a page suite to be used on the iPortal server and add special content or information to the page suite, for example, a logo or notice.

Notes

- A page suite must be downloaded manually to the flash memory of the NAS and saved to the `./portal` directory. If the page suite is not saved or is saved to an incorrect directory, page push will fail, causing Web authentication invalid. The default page suite can be used if there are no special requirements.
- For details, see section 1.4.36 "Customizing a Page Suite."

Configuration Steps

- (Optional) By default, the default page suite is used.

Verification

- Configure Ruijie iPortal Web Authentication.
- Download a page suite.
- Specify the page suite.
- Check whether the page suite is applied to the login page.

Related Commands

↳ Customizing a Page Suite

| | |
|---------------------|--|
| Command | <code>page-suit filename</code> |
| Parameter | <i>filename</i> : Indicates the file name of a page suite. |
| Description | |
| Command Mode | Webauth template configuration mode |
| Usage Guide | Download the page suite to be used to the <code>./porta/zip</code> directory of the flash memory in advance. |

Configuration Example

↳ Customizing a Page Suite

| | |
|----------------------------|---|
| Configuration Steps | <ul style="list-style-type: none"> ● Customize a page suite. |
| | <code>Ruijie(config, tmplt, iportal)#page-suitruijiepage</code> |
| Verification | <ul style="list-style-type: none"> ● Check whether the configuration is successful. |
| | <pre>Ruijie#show web-auth template Webauth Template Settings: ----- Name: iportal Page-suit: ruijiepage Advertising url: default Advertising mode: online-popup Type: Intral Portal Acctmlist:default Authmlist:default</pre> |

1.4.12. Configuring the Advertisement Pushing Mode

Configuration Effect

- Optional. Advertisements are pushed before or after authentication.

Notes

- By default, advertisements are pushed after authentication is successful.
- To ensure that only advertisements are pushed in the case that users are not authenticated, select the advertising function. For details, see the advertising configuration manual.

Configuration Steps

- (Optional) By default, advertisements are pushed after the authentication is successful.

Verification

- Configure embedded portal Web authentication.
- Configure a URL address that can access the Internet.
- When a user accesses the network, check whether a new window is displayed after the authentication is successful and whether information on a page of a specific URI is displayed.

Related Commands

↘ Configuring the Advertisement Pushing Address

| | |
|------------------------------|---|
| Command | popup mode [login-popup online-popup] url |
| Parameter Description | login-popup: Indicates the address is pushed before authentication (during login). online-popup: Indicates the address is pushed after successful authentication. <i>url.</i> Indicates the pushed address. |
| Command Mode | Webauth template configuration mode |
| Usage Guide | By default, the address pops up after successful authentication. |

Configuration Example

↘ Configuring the Advertisement Pushing Mode

| | |
|----------------------------|---|
| Configuration Steps | <ul style="list-style-type: none"> ● Configure the advertisement pushing mode to advertisement pushing before authentication. |
| | <pre>Ruijie(config.tmpl.t.iportal)#login-popup http://www.ruijie.com.cn/ Ruijie(config.tmpl.t.iportal)#popup mode login-popup</pre> |
| Verification | <ul style="list-style-type: none"> ● Check whether the advertisement pushing mode is configured successfully. |
| | <pre>Ruijie#show web-auth template Webauth Template Settings: ----- Name: iportal Page-suit: default Advertising url: http://www.ruijie.com.cn/ Advertising mode: login-popup Type: Intral Portal Acctmlist:default Authmlist:default</pre> |

1.4.13. Configuring the Format of the Webauth URL

Configuration Effect

- Configure the URL used for redirecting users to the portal server based on the customized parameters.

Notes

- The parameter sequence of the customized URL may not be consistent with the parameter sequence of the actual URL.

Configuration Steps

- Optional.

Verification

- Configure a customized URL.
- Open the browser of a PC and access the Internet through the port without performing authentication.
- Check whether the access requests are redirected and the parameters of the redirection URL are consistent with those of the customized URL.

Related Commands

▾ Configuring the Format of the Webauth URL

| | |
|------------------------------|---|
| Command | <code>fmt custom [encrypt { md5 des des_ecb des_ecb3 none }] [user-ip userip-str] [user-mac usermac-str mac-format [dot line none]] [user-vid uservid-str] [user-id userid-str] [nas-ip nasip-str] [nas-id nasid-str] [nas-id2 nasid2-str] [ac-name acname-str] [ap-mac apmac-str mac-format [dot line none]] [url url-str] [ssid ssid-str] [port port-str] [ac-serno ac-sno-str] [ap-serno ap-sno-str] [additional extern-str]</code> |
| Parameter Description | <p><i>userip-str</i>: Indicates the parameter name mapped to the IP address of an STA.</p> <p><i>usermac-str</i>: Indicates the parameter name mapped to the MAC address of an STA.</p> <p><i>uservid-str</i>: Indicates the parameter name mapped to the VID of an STA.</p> <p><i>userid-str</i>: Indicates the parameter name mapped to the ID of an STA.</p> <p><i>nasip-str</i>: Indicates the parameter name mapped to the IP address of the NAS.</p> <p><i>nasid-str</i>: Indicates the parameter name mapped to the ID of the NAS.</p> <p><i>nasid2-str</i>: Indicates the parameter name mapped to the ID of the NAS. (Two NAS IDs can be configured.)</p> <p><i>ac-name</i>: Indicates the parameter name mapped to the name of the NAS.</p> <p><i>apmac-str</i>: Indicates the parameter name mapped to the MAC address of the associated AP.</p> <p><i>url-str</i>: Indicates the parameter name mapped to the original URL that the STA accesses.</p> <p><i>ssid-str</i>: Indicates the parameter name mapped to the SSID.</p> <p><i>port-str</i>: Indicates the parameter name mapped to the user authentication port.</p> <p><i>ac-sno-str</i>: Indicates the parameter name mapped to the serial number of the AC.</p> <p><i>ap-sno-str</i>: Indicates the parameter name mapped to the serial number of the NAS.</p> <p><i>extern-str</i>: Indicates a fixed character string. Some portal servers must be identified by character strings.</p> |

| | |
|---------------------|--|
| | <p><i>md5</i>: Indicates MD5 mode.</p> <p><i>des</i>: Indicates DES mode.</p> <p><i>des_ecb</i>: Indicates DES_ECB mode.</p> <p><i>des_ecb3</i>: Indicates DES_ECB3 mode.</p> <p><i>none</i>: Indicates no encryption.</p> |
| Command Mode | Template configuration mode |
| Usage Guide | You can add or delete individual parameters. |

Configuration Example

Configuring the Format of the Webauth URL

| | |
|----------------------------|---|
| Configuration Steps | <ul style="list-style-type: none"> Configure the plaintext IP address and MAC address of an STA, IP address of the NAS, SSID, URL, and other parameters as the redirection URL parameters. |
| | <pre>Ruijie(config.tmpl.eportalv2)# fmt custom encry none user-ip userip user-mac usermac mac-format none nas-ip nasip ssid ssid url firstu</pre> |
| Verification | <ul style="list-style-type: none"> Check whether the configuration is successful. |
| | <pre>Ruijie(config)#show running-config ... fmt custom encry none user-ip userip user-mac usermac mac-format none nas-ip nasip ssid ssid url firsturl</pre> |

1.4.14. Configuring the Redirection HTTP Port

Configuration Effect

- When an STA accesses network resources (for example, the user accesses the Internet using a browser), the STA sends HTTP packets. The NAS or convergence device intercepts these HTTP packets to determine whether the STA is accessing network resources. If the NAS or convergence device detects that the STA is not authenticated, it prevents the STA from accessing network resources and displays an authentication page to the STA. By default, the NAS intercepts the HTTP packets that STAs send to port 80 to determine whether STAs are accessing network resources.
- After a redirection HTTP port is configured, the HTTP requests that STAs send to the specified destination port can be redirected.

Notes

- The commonly used management ports on the NAS or convergence device, such as ports 22, 23 and 53, and ports reserved by the system are not allowed to be configured as the redirection port. All ports except port 80 with numbers smaller than 1000 are seldom used by the HTTP protocol. To avoid a conflict with the well-known TCP port, do not configure a port with a small number as the redirection port unless necessary.

Configuration Steps

- Optional.
- When you configure automatic client acquisition, if you need to enable the NAS to intercept the HTTP packets that STAs send to the specified destination port, configure a redirection HTTP port.

Verification

- Configure an interception port.
- Open the browser of a PC and access the Internet through the port without performing authentication.
- Check whether the access requests are redirected to an authentication page.

Related Commands

▾ Configuring the Redirection HTTP Port

| | |
|------------------------------|---|
| Command | <code>http redirect port <i>port-num</i></code> |
| Parameter Description | <i>port-num</i> : Indicates the port number. |
| Command Mode | Global configuration mode |
| Usage Guide | A maximum of 10 different destination port numbers can be configured, not including default ports 80 and 443. |

Configuration Example

▾ Configuring the Redirection HTTP Port

| | |
|----------------------------|---|
| Configuration Steps | <ul style="list-style-type: none"> ● Configure port 8080 as the redirection HTTP port. |
| | <pre>Ruijie(config)#http redirect port 8080</pre> |
| Verification | <ul style="list-style-type: none"> ● Check whether the configuration is successful. |
| | <pre>Ruijie(config)#show web-auth rdport Rd-Port: 80 443 8080</pre> |

1.4.15. Configuring Rate Limit Webauth Logging

Configuration Effect

- The Web authentication module sends syslog messages to the administrator to display the information and relevant events of users who perform login/logout. By default, syslog messages are shielded.

- After syslog output rate limiting is configured, syslog messages are sent at a certain rate.

Notes

- When the login/logout rate is high, syslog messages are output frequently, which affects device performance and results in spamming.

Configuration Steps

- Optional.
- Configure syslog output rate limiting when you need to view the syslog messages about user login/logout.

Verification

- Configure logging rate limiting.
- Check whether users log in and out at a certain rate.
- Check that syslog messages are printed out at the limit rate.

Related Commands

▾ Configuring Rate Limit Webauth Logging

| | |
|------------------------------|--|
| Command | web-auth logging enable <i>num</i> |
| Parameter Description | <i>num</i> : Indicates the syslog output rate (entry/second). |
| Command Mode | Global configuration mode |
| Usage Guide | When the syslog output rate is set to 0 , syslog messages are output without limit. The output of syslog messages of the critical level and syslog messages indicating errors is not limited. |

Configuration Example

▾ Configuring Rate Limit Webauth Logging

| | |
|----------------------------|--|
| Configuration Steps | <ul style="list-style-type: none"> ● Disable rate limit Webauth Logging. <pre>Ruijie(config)#web-auth logging enable 0</pre> |
| Verification | <ul style="list-style-type: none"> ● Check whether the configuration is successful. <pre>Ruijie(config)#show running-config ... web-auth logging enable 0 ...</pre> |

1.4.16. Configuring the Maximum Number of HTTP Sessions for Unauthenticated Clients

Configuration Effect

- When an unauthenticated user accesses network resources, the user's PC sends requests for HTTP session connection. The NAS or convergence device intercepts the HTTP packets and redirects the user to a Web authentication page. To prevent an unauthenticated user from initiating too many HTTP connection requests and save resources on the NAS, it is necessary to limit the maximum number of HTTP sessions that the unauthenticated user can initiate on the NAS.
- A user occupies an HTTP session when performing authentication, and the other application programs of the user may also occupy HTTP sessions. For this reason, it is recommended that the maximum number of HTTP sessions for an unauthenticated user be not set to 1. By default, each unauthenticated user can initiate 255 HTTP sessions globally, and each port supports up to 300 HTTP sessions initiated by unauthenticated clients.

Notes

- If the authentication page fails to be displayed during Web authentication, the maximum number of HTTP sessions may be reached. When this happens, the user can close the application programs that may occupy HTTP sessions and then perform Web authentication again.

Configuration Steps

- Optional.
- Perform this configuration when you need to change the maximum number of HTTP sessions that each unauthenticated user can initiate and the maximum number of HTTP sessions that unauthenticated clients can initiate on each port.
- Perform this configuration when you configure automatic SU client acquisition.

Verification

- Modify the maximum number of HTTP sessions that an unauthenticated user can initiate.
- Simulate the scenario where an unauthenticated user constructs identical sessions to connect to the NAS continuously.
- Simulate the scenario where the unauthenticated user accesses the Internet using a browser. Check whether the access requests are redirected and the NAS notifies the user that the maximum number of sessions is reached.

Related Commands

↘ Configuring the Maximum Number of HTTP Sessions for Unauthenticated Clients

| | |
|------------------------------|--|
| Command | http redirect session-limit { <i>session-num</i> } [port { <i>port-session-num</i> }] |
| Parameter Description | <p><i>session-num</i>: Indicates the maximum number of HTTP sessions for unauthenticated clients. The value range is 1 to 255. The default value is 255.</p> <p><i>port-session-num</i>: Indicates the maximum number of HTTP sessions on each port for authenticated clients. The value range is 1 to 65,535. The default value is 300.</p> |

| | |
|---------------------|---------------------------|
| Command Mode | Global configuration mode |
| Usage Guide | N/A |

Configuration Example

Configuring the Maximum Number of HTTP Sessions for Unauthenticated Clients

| | |
|----------------------------|--|
| Configuration Steps | <ul style="list-style-type: none"> Set the maximum number of HTTP sessions for unauthenticated clients to 3. |
| | <pre>Ruijie(config)#http redirect session-limit 3</pre> |
| Verification | <ul style="list-style-type: none"> Check whether the configuration is successful. |
| | <pre>Ruijie(config)#show web-auth parameter HTTP redirection setting: session-limit: 3 timeout: 3 Ruijie(config)#</pre> |

1.4.17. Configuring the HTTP Redirection Timeout

Configuration Effect

- Configure the HTTP redirection timeout to maintain redirection connections. When an unauthenticated user tries to access network resources through HTTP, the TCP connection requests sent by the user will be intercepted and re-established with the NAS or convergence device. Then, the NAS or convergence device waits for the HTTP GET/HEAD packets from the user and responds with HTTP redirection packets to close the connection. The redirection timeout is intended to prevent the user from occupying the TCP connection for a long time without sending GET/HEAD packets. By default, the timeout for maintaining a redirection connection is 3s.

Notes

N/A

Configuration Steps

- Optional.
- Perform this configuration to change the timeout for maintaining redirection connections.

Verification

- Change the timeout period.
- Use a network packet delivery tool to set up a TCP connection.

- View the status of the TCP connection on the NAS. Check whether the TCP connection is closed when the timeout is reached.

Related Commands

↘ Configuring the HTTP Redirection Timeout

| | |
|------------------------------|---|
| Command | <code>http redirect timeout { seconds }</code> |
| Parameter Description | <i>Seconds</i> : Indicates the timeout for maintaining redirection connections, in the unit of seconds. The value ranges from 1 to 10. The default value is 3s. |
| Command Mode | Global configuration mode |
| Usage Guide | N/A |

Configuration Example

↘ Configuring the HTTP Redirection Timeout

| | |
|----------------------------|---|
| Configuration Steps | <ul style="list-style-type: none"> ● Set the HTTP redirection timeout to 5s. <pre>Ruijie(config)#http redirect timeout 5</pre> |
| Verification | <ul style="list-style-type: none"> ● Check whether the configuration is successful. <pre>Ruijie(config)#show web-auth parameter HTTP redirection setting: session-limit: 255 timeout: 5</pre> |

1.4.18. Configuring the Straight-Through Network Resources

Configuration Effect

- After Web authentication or 802.1Xauthentication is enabled on a port, the users connecting to the port need to pass Web authentication or 802.1Xauthentication before accessing network resources.
- Perform this configuration to exempt users from authentication when accessing some network resources.
- If a website is configured as a network resource of authentication exemption, all users, including unauthenticated clients, can access the website. By default, authentication exemption is not configured, and unauthenticated clients are not allowed to access network resources.
- IPv6 is supported.

Notes

- The maximum number of free resources and the maximum number of unauthenticated clients cannot exceed 1000 respectively. The actual number of available resources may be reduced because of other security modules. Therefore, it is recommended that network segments be configured if many addresses need to be set.
- **http redirect direct-site** is used to configure the straight-through URL address for users, and **http redirect** is used to configure the straight-through IP address of the Web authentication server. The addresses configured using the two commands can be accessed without authentication, but they have different usages. It is recommended not to configure the IP address of the Web authentication server by using **http redirect direct-site**.
- When IPv6 addresses are used, you need to allow local link address learning. If this function is not configured, the NAS cannot learn the MAC addresses of clients.

Configuration Steps

- Optional.
- Run the **http redirect direct-site** command to enable unauthenticated clients to access network resources.

Verification

- Configure the straight-through network resources.
- Check whether unauthenticated clients can access the configured network resources using PCs.

Related Commands

⤵ Configuring the Straight-Through Network Resources

| | |
|------------------------------|--|
| Command | http redirect direct-site { <i>ipv6-address</i> <i>ipv4-address</i> [<i>ip-mask</i>] [arp] } |
| Parameter Description | <i>ipv6-address</i> : Indicates the IPv6 address of the network exempt from authentication. <i>ipv4-address</i> : Indicates the IPv4 address of the network exempt from authentication. <i>ip-mask</i> : Indicates the mask of the IPv4 address of the network exempt from authentication. |
| Command Mode | Global configuration mode |
| Usage Guide | To set authentication-exempted ARP resource, use the http redirect direct-arp command preferentially. |

Configuration Example

⤵ Configuring the Straight-Through Network Resources

| | |
|----------------------------|---|
| Configuration Steps | <ul style="list-style-type: none"> ● Configure the straight-through network resources as 192.168.0.0/16. |
| | <pre>Ruijie(config)#http redirect direct-site 192.168.0.0 255.255.0.0</pre> |
| Verification | <ul style="list-style-type: none"> ● Check whether the configuration is successful. |
| | <pre>Ruijie(config)#show web-auth direct-site Direct sites:</pre> |

| Configuration Steps | <ul style="list-style-type: none"> Configure the straight-through network resources as 192.168.0.0/16. | | | | | | | | |
|----------------------------|---|---------|---------------|-----|---------------|-------------|-------------|-----|-----|
| | <pre>Ruijie(config)#http redirect direct-site 192.168.0.0 255.255.0.0</pre> | | | | | | | | |
| Verification | <ul style="list-style-type: none"> Check whether the configuration is successful. | | | | | | | | |
| | <table border="1"> <thead> <tr> <th>Address</th> <th>Mask</th> <th>ARP</th> <th>Binding Group</th> </tr> </thead> <tbody> <tr> <td>192.168.0.0</td> <td>255.255.0.0</td> <td>Off</td> <td>N/A</td> </tr> </tbody> </table> <pre>Ruijie(config)#</pre> | Address | Mask | ARP | Binding Group | 192.168.0.0 | 255.255.0.0 | Off | N/A |
| Address | Mask | ARP | Binding Group | | | | | | |
| 192.168.0.0 | 255.255.0.0 | Off | N/A | | | | | | |

1.4.19. Configuring the Straight-Through ARP Resource Range

Configuration Effect

When ARP check or similar functions are enabled, the ARP learning performed by clients is controlled. As a result, clients cannot learn the ARPs of the gateway and other devices, which affects user experience. You can configure the straight-through ARP resource range to permit the ARP learning packets destined for the specified address to pass.

Notes

- When ARP check is enabled, you need to configure the gateway of the PCs connecting to the Layer-2 access device as a straight-through ARP resource. Note the following point when you perform the configuration:
- When you configure straight-through websites and ARP resources in the same address or network segment, the **http redirect direct-arp** command automatically combines the websites and ARP resources. If no ARP option is specified for the configured websites, an ARP option will be automatically added after the combination.
- When ARP check is enabled, if the outbound addresses of the PCs connecting to the Layer-2 access device are not the gateway address, configure the outbound addresses as straight-through ARP resources. If multiple outbound addresses exist, configure these addresses as straight-through ARP resources.

Configuration Steps

- Optional.
- If ARP check is enabled on the NAS, you must configure the free resources and gateway address as straight-through ARP resources.

Verification

- Configure straight-through ARP resources.
- Clear the ARP cache of the PC of an unauthenticated user. (Run the **arp -d** command in the Windows operating system.)
- Run the **ping** command on the PC to access the straight-through ARP resources.

- View the ARP cache on the PC (run the **arp -a** command in the Windows operating system) and check whether the PC learns the ARP address of the straight-through ARP resources.

Related Commands

↘ Configuring the Straight-Through ARP Resource Range

| | |
|---------------------|--|
| Command | http redirect direct-arp { <i>ip-address</i> [<i>ip-mask</i>] } |
| Parameter | <i>ip-address</i> : Indicates the IP address of free resources. |
| Description | <i>ip-mask</i> : Indicates the mask of free resources. |
| Command Mode | Global configuration mode |
| Usage Guide | N/A |

Configuration Example

↘ Configuring the Straight-Through ARP Resource

| | |
|----------------------------|--|
| Configuration Steps | <ul style="list-style-type: none"> ● Configure the straight-through ARP resource as 192.168.0.0/16. |
| | <pre>Ruijie(config)#http redirect direct-arp 192.168.0.0 255.255.0.0</pre> |
| Verification | <ul style="list-style-type: none"> ● Check whether the configuration is successful. |
| | <pre>Ruijie(config)#show web-auth direct-arp Direct arps: Address Mask ----- 192.168.0.0 255.255.0.0 Ruijie(config)#</pre> |

1.4.20. Configuring an Authentication-Exempted Address Range

Configuration Effect

- Exempt users from Web authentication when accessing reachable network resources. By default, no authentication-exempted address range is configured. All users must pass Web authentication before accessing network resources.
- The authentication-exempted address range can be configured as an IP address range or MAC address range.

Notes

N/A

Configuration Steps

- Optional.
- Perform this configuration to allow unauthenticated clients to access network resources.

Verification

- Configure an authentication-exempted user.
- Check whether the user can access the Internet without authentication.

Related Commands

↘ Configuring an Authentication-Exempted Address Range

| | |
|------------------------------|--|
| Command | web-auth direct-host { <i>ipv4-address</i> [<i>ip-mask</i>] [arp] <i>ipv6-address</i> <i>mac-address</i>][port <i>interface-name</i>] |
| Parameter Description | <p><i>ipv4-address</i>: Indicates the IPv4 address of the user exempt from authentication.</p> <p><i>ipv6-address</i>: Indicates the IPv6 address of the user exempt from authentication.</p> <p><i>ip-mask</i>: Indicates the mask of the IPv4 address of the user exempt from authentication.</p> <p><i>interface-name</i>: Indicates the name of the interface on which authentication exemption is enabled.</p> <p><i>mac-address</i>: Indicates the MAC address of the user exempt from authentication.</p> |
| Command Mode | Global configuration mode |
| Usage Guide | <p>The arp field is used to assign pass permissions to ARP packets. This field must be set when ARP check is enabled.</p> <p>After the port field is set, authentication exemption takes effect only on the configured interface.</p> |

Configuration Example

↘ Configuring an Authentication-Exempted Address Range

| Configuration Steps | <ul style="list-style-type: none"> ● Configure an authentication-exempted address range. | | | | | | | | | | | | | | | |
|----------------------------|--|---------|-------------|-------|-------------|-------|-------|-------|-------|-------|-------|----------------|-----------------|--|-----|-----|
| | <pre>Ruijie (config)# web-auth direct-host 192.168.197.64</pre> | | | | | | | | | | | | | | | |
| Verification | <ul style="list-style-type: none"> ● Check whether the configuration is successful. | | | | | | | | | | | | | | | |
| | <pre>Ruijie(config)#show web-auth direct-host</pre> <p>Direct hosts:</p> <table border="1"> <thead> <tr> <th>Address</th> <th>Mask</th> <th>Port</th> <th>ARP Binding</th> <th>Group</th> </tr> </thead> <tbody> <tr> <td>-----</td> <td>-----</td> <td>-----</td> <td>-----</td> <td>-----</td> </tr> <tr> <td>192.168.197.64</td> <td>255.255.255.255</td> <td></td> <td>Off</td> <td>N/A</td> </tr> </tbody> </table> | Address | Mask | Port | ARP Binding | Group | ----- | ----- | ----- | ----- | ----- | 192.168.197.64 | 255.255.255.255 | | Off | N/A |
| Address | Mask | Port | ARP Binding | Group | | | | | | | | | | | | |
| ----- | ----- | ----- | ----- | ----- | | | | | | | | | | | | |
| 192.168.197.64 | 255.255.255.255 | | Off | N/A | | | | | | | | | | | | |

```
Ruijie(config)#
```

1.4.21. Configuring the Interval for Updating Online User Information

Configuration Effect

- The NAS or convergence device maintains and periodically updates the information of online users, including users' online duration, to monitor the usage of network resources. When the online duration threshold is reached, users will be prevented from using network resources.

Notes

- The user information updating interval must be configured as 60 or multiple of 60; otherwise, the system will select the minimum multiple of 60 above and closest to the actual configuration as the interval.

Configuration Steps

- Optional.
- Perform this configuration to allow unauthenticated clients to access network resources.

Verification

- Configure the interval for updating online user information.
- View the information of online users after the update interval has elapsed.

Related Commands

↘ Configuring the Interval for Updating Online User Information

| | |
|------------------------------|---|
| Command | web-auth update-interval { <i>seconds</i> } |
| Parameter Description | <i>seconds</i> : Indicates the interval for updating online user information, in the unit of seconds. The value ranges from 30 to 3,600. The default value is 180s. |
| Command Mode | Global configuration mode |
| Usage Guide | To restore the default updating interval, run the no web-auth update-interval command in global configuration mode. |

Configuration Example

↘ Configuring the Interval for Updating Online User Information

| | |
|----------------------------|---|
| Configuration Steps | <ul style="list-style-type: none"> ● Set the interval for updating online user information to 60s. |
| | <pre>Ruijie (config)# web-auth update-interval 60</pre> |
| Verification | <ul style="list-style-type: none"> ● Check whether the configuration is successful. |

```
Ruijie(config)#show run | include web-auth update-interval
web-auth update-interval 60
```

1.4.22. Configuring Portal Detection

Configuration Effect

- Detect the availability of the active portal server periodically. When the active portal server is unavailable, the standby portal server takes over the services.
- Ruijie Second-Generation Web Authentication provides two detection methods. One is that the NAS constructs and sends portal packets to the portal server. If the portal server returns response packets, the NAS determines that the portal server is available. Another is the NAS sends ping packets to the portal server. If the portal server returns response packets, the NAS determines that the portal server is available. Because some servers or intermediate network segments filter ping packets, the first method is commonly used. The ping detection method is only used based on special requirements. In Ruijie First-Generation Web Authentication, the NAS connects to a port of the portal server and checks whether the port is reachable. If the portal is reachable, the NAS determines that the portal server is available.
- For the first method in the second-generation authentication, the interval of server availability detection is specified by the **interval** parameter, and the maximum number of packets that can be sent during each time of detection is specified by the **retransmit** parameter. If the portal server does not respond, the NAS determines that the portal server is unavailable. The timeout period for each packet is specified by the **timeout** parameter. The parameter settings are also supported by Ruijie First-Generation Web Authentication.
- Portal server detection takes effect for Ruijie First- and Second-Generation Web Authentication.
- If multiple portal servers are configured, these servers are working in active/standby mode.

Notes

- Multiple portal servers must be configured to realize failover when an error is detected on one server.
- Only one of the two detection methods can be used at a time in case of collision. If both detection methods are configured, a detection algorithm conflict will occur or the detection results will be inaccurate.
- The system will automatically select a detection method based on whether Ruijie First- or Second-Generation Web Authentication is used.

Configuration Steps

- Optional.
- Configure multiple portal server templates applicable to Ruijie First- or Second-Generation Web Authentication.

Verification

- Configure two portal server templates for Ruijie First- or Second-Generation Web Authentication. Make the first template point to an unavailable server and the second template point to an available server.

- When the Console displays a log indicating that the portal server is not available, simulate the scenario where a user opens a browser to perform login authentication. Check whether the user is redirected to the second portal server.

| | |
|------------------------------|--|
| Command | web-auth portal-check [interval <i>intsec</i> [timeout <i>tosec</i>][retransmit <i>retries</i>] |
| Parameter Description | <i>intsec</i> : Indicates the detection interval. The default value is 10s. <i>tosec</i> : Indicates the packet timeout period. The default value is 5s. <i>intsec</i> : Indicates the timeout retransmission times. The default value is 3 (times). |
| Command Mode | Global configuration mode |
| Usage Guide | In many network environments, only one portal server is deployed, and portal server detection does not need to be configured. If multiple portal servers exist, it is recommended that the parameters of portal server detection be not set to small values; otherwise, the NAS will send many packets within a short time, affecting performance. |
| Command | web-auth ping [interval <i>minutes</i>] [retry <i>times</i>] |
| Parameter Description | <i>minutes</i> : Indicates the detection interval. The default value is 1 minute. <i>times</i> : Indicates the timeout retransmission times. The default value is 3 (times). |
| Command Mode | Global configuration mode |
| Usage Guide | In many network environments, only one portal server is deployed, and portal server detection does not need to be configured. If multiple portal servers exist, it is recommended that the parameters of portal server detection be not set to small values; otherwise, the NAS will send many packets within a short time, affecting performance. |

Configuration Example

Configuring Portal Detection

| | |
|----------------------------|---|
| Configuration Steps | <ul style="list-style-type: none"> ● Configure portal detection. <pre>Ruijie(config)#web-auth portal-check interval 20 timeout 2 retransmit 2</pre> |
| Verification | <ul style="list-style-type: none"> ● Check whether the configuration is successful. <pre>Ruijie(config)#show running-config ... web-auth portal-check interval 20 timeout 2 retransmit 2 ...</pre> |

1.4.23. Configuring Portal Escape

Configuration Effect

- Allow new users to access the Internet without authentication when the portal server is not available.

Notes

- To use the portal escape function, you must configure portal detection.
- If multiple portal servers are configured, the escape function takes effect only when all the portal servers are not available.
- The escape function is intended only for the portal server, instead of the RADIUS server.

Configuration Steps

- Optional.
- Configure portal detection.
- Configure portal escape.
- (Optional) Configure the nokick attribute.

Verification

- Configure a portal server and disable the server.
- Configure the portal detection and escape functions.
- When the NAS detects that the portal server is not available, check whether a client accesses the Internet without authentication.

Related Commands

↘ Configuring Portal Escape

| | |
|------------------------------|---|
| Command | web-auth portal-escape [nokick] |
| Parameter Description | N/A |
| Command Mode | Global configuration mode |
| Usage Guide | Configure portal escape if the continuity of some critical services on the network needs to be maintained when the portal server is faulty. You must configure portal detection when you use this function. If the nokick attribute is configured, the system does not force users offline when the escape function takes effect. If the nokick attribute is deleted, the system forces users offline. |

Configuration Example

↘ Configuring Portal Escape

| | |
|----------------------------|--|
| Configuration Steps | <ul style="list-style-type: none"> Configure portal escape. |
| | <pre>Ruijie(config)#web-auth portal-escape</pre> |
| Verification | <ul style="list-style-type: none"> Check whether the configuration is successful. |
| | <pre>Ruijie(config)#show running-config ... web-auth portal-escape ...</pre> |

1.4.24. Enabling DHCP Address Check

Configuration Effect

- Allow only the clients that are allocated with IP addresses through DHCP to perform authentication.

Notes

- To use the DHCP address check function, you must configure DHCP snooping.
- DHCP address check is supported only for IPv4.
- DHCP address check is applicable only to Ruijie Second-Generation Web Authentication and iPortal Web Authentication.
- The requirement that users obtain IP addresses through DHCP must be specified during network deployment. Those users cannot also use static IP addresses; otherwise, the existing users that use static IP addresses will be affected.
- If a few users need to use static IP addresses, configure these IP addresses as straight-through addresses, and these users are exempt from authentication.
- If DHCP address check needs to be enabled only on some interfaces or some VLANs of interfaces, disable the global DHCP address check and configure the VLAN range in which DHCP address check needs to be enabled in each interface.

Configuration Steps

- Optional.
- Enable DHCP snooping.
- Enable DHCP address check.

Verification

- Enable DHCP address check.
- Configure a static IP address that is not allocated by the DHCP server on a client.

- Connect the client to the Internet and check whether the STA cannot perform authentication.

Related Commands

▾ Enabling Global DHCP Address Check

| | |
|---------------------|---|
| Command | web-auth dhcp-check |
| Parameter | N/A |
| Description | |
| Command Mode | Global configuration mode |
| Usage Guide | Configure DHCP address check to allow only the users who obtain IP addresses through DHCP to access the Internet. This function helps prevent the users who configure IP addresses without authorization from performing authentication to access the Internet. |

Configuration Example

▾ Enabling DHCP Address Check

| | |
|----------------------------|---|
| Configuration Steps | <ul style="list-style-type: none"> ● Enable global DHCP address check. |
| | <pre>Ruijie(config)#web-auth dhcp-check</pre> |
| Verification | <ul style="list-style-type: none"> ● Check whether the configuration is successful. |
| | <pre>Ruijie(config)#show running-config ... web-auth dhcp-check ... interface TenGigabitEthernet 3/1 web-auth dhcp-check vlan 1,3-4 ...</pre> |

1.4.25. Disabling Link Detection

Configuration Effect

- The authentication entries of clients are kept when links are disconnected. The clients can access the Internet again without authentication if the IP addresses remain unchanged.
- You can disable link detection in places where mobile office is required or wireless Web authentication is deployed but wireless signal is bad.

Notes

- Do not disable link detection if clients obtain IP addresses through DHCP and the number of IP addresses in the DHCP address pool is smaller than the number of clients. If link detection is disabled, the IP address of a client that has logged out may be obtained by another client, causing a user information error.
- If link detection is disabled, a client logout action is triggered only when the user clicks the **Logout** button on the online page, the server forces the client offline, or the NAS detects low traffic on the client. It is recommended that you enable low traffic detection if you need to disable link detection. For details, see the *Configuring SCC*.
- It is recommended that you disable link detection and enable low traffic detection in a wireless environment. The reason is that the offline rate in a wireless environment is high because wireless connections are easily affected by signal interference, and disabling link detection helps improve wireless experience.

Configuration Steps

- Optional.
- Configure Web authentication.
- Disable link detection.

Verification

- Configure Ruijie-Second Generation Web Authentication and disable link detection.
- Connect a client to the Internet and perform authentication. When the client passes the authentication, disconnect from and then reconnect to the Internet with the same IP address. Check whether the client can access the Internet again without authentication.

Related Commands

↘ Disabling Link Detection

| | |
|------------------------------|--|
| Command | no web-auth sta-leave detection |
| Parameter Description | N/A |
| Command Mode | Global configuration mode |
| Usage Guide | You can disable link detection in a wireless environment or a wired environment with the need for mobile office. To disable link detection, you must enable low traffic detection. |

Configuration Example

↘ Disabling Link Detection

| | |
|----------------------------|---|
| Configuration Steps | <ul style="list-style-type: none"> ● Disable link detection. |
| | <pre>Ruijie(config)#no web-auth sta-leave detection</pre> |
| | |

| | |
|---------------------|--|
| Verification | <ul style="list-style-type: none"> ● Check whether the configuration is successful. |
| | <pre>Ruijie(config)#show running-config ... no web-auth sta-leave detection ...</pre> |

1.4.26. Disabling Portal Extension

Configuration Effect

- Enable portal extension to support Ruijie portal server and portal servers that comply with the CMCC WLAN Service Portal Specification.
- You can select multiple redirection URL formats when interworking with the servers comply with the CMCC WLAN Service Portal Specification to achieve compatibility with different servers.

Notes

- Only Ruijie Second-Generation Web Authentication supports portal extension.
- Ruijie Second-Generation Web Authentication extends the CMCC WLAN Service Portal Specification. You need to determine whether to use the extension mode based on the server performance.
- If the portal server is a product of Ruijie, use the default mode, that is, extension mode. If the portal server complies with the CMCC WLAN Service Portal Specification, disable portal extension.
- The CMCC WLAN Service Portal Specification supports multiple redirection URL formats. If the portal server complies with the CMCC WLAN Service Portal Specification, select a redirection URL format supported by the server.

Configuration Steps

- Optional.
- Determine whether to disable portal extension based on the server type.
- Select a redirection URL format supported by the server if portal extension is disabled.

Verification

- Select Ruijie portal server and a portal server compliant with the CMCC WLAN Service Portal Specification to be used in Ruijie Second-Generation Web Authentication.
- Connect a client to the Internet. Check whether the client performs authentication normally on the two servers and can access the Internet.

Related Commands

- ↘ [Disabling Portal Extension](#)

| | |
|---------------------|---|
| Command | no web-auth portal extension |
| Parameter | N/A |
| Description | |
| Command Mode | Global configuration mode |
| Usage Guide | The portal servers that comply with the <i>CMCC WLAN Service Portal Specification</i> are deployed. If Ruijie portal server is used, enable portal extension. |

Configuration Example

Disabling Portal Extension

| | |
|----------------------------|--|
| Configuration Steps | <ul style="list-style-type: none"> Disable portal extension. |
| | <pre>Ruijie(config)#no web-auth web-auth portal extension</pre> |
| | <pre>Ruijie(config)# http redirect url-fmt ext1</pre> |
| Verification | <ul style="list-style-type: none"> Check whether the configuration is successful. |
| | <pre>Ruijie(config)#show running-config ... no web-auth web-auth portal extension http redirect url-fmt ext1 ...</pre> |

1.4.27. Configuring a Whitelist and Blacklist

Configuration Effect

- Configure a whitelist to allow unauthenticated clients to access some network resources, and configure a blacklist to prevent authenticated clients from accessing some network resources.
- Blacklists and whitelists are supported based on ports, URLs, and IP addresses.

Notes

- Up to 1,000 blacklists and whitelists can be configured.
- If blacklists and whitelists are configured in the domain name format, the DNS function must be configured on the NAS so that the NAS can resolve IP addresses correctly.
- A domain name can map up to eight IP addresses.

Configuration Steps

- Optional.
- Configure DNS.
- Configure a whitelist and blacklist.

Verification

- Configure a whitelist and blacklist.
- Check whether unauthenticated STAs can access the whitelisted addresses.
- Check whether authenticated STAs cannot access the blacklisted addresses.

Related Commands

↘ Configuring a Whitelist and Blacklist

| | |
|------------------------------|--|
| Command | web-auth acl{black-ip ip black-port port black-url name white-url name} |
| Parameter Description | <i>ip</i> : Indicates an IP addresses blacklisted. <i>port</i> : Indicates a port numbers blacklisted. <i>name</i> : Indicates a URL blacklisted or whitelisted. |
| Command Mode | Global configuration mode (Blacklists can be configured in WLAN security configuration mode on wireless devices.) |
| Usage Guide | Configure a whitelist to allow unauthenticated clients to access some network resources, and configure a blacklist to prevent authenticated clients from accessing some network resources. |

Configuration Example

↘ Configuring a Whitelist and Blacklist

| | |
|----------------------------|---|
| Configuration Steps | <ul style="list-style-type: none"> ● Configure a whitelist and blacklist. <pre>Ruijie(config)#web-auth acl black-ip 192.168.1.2 Ruijie(config)#web-auth acl white-url www.ruijie.com.cn</pre> |
| Verification | <ul style="list-style-type: none"> ● Check whether the configuration is successful. <pre>Ruijie(config)#show running-config ... web-auth acl black-ip 192.168.1.2 web-auth acl white-url www.ruijie.com.cn ...</pre> |

1.4.28. Configuring Jitter-off Accounting

Configuration Effect

- If jitter-off or low traffic detection is configured on the NAS, the time of jitter-off or low traffic detection will be accounted into the online duration. Jitter-off accounting is used to reduce the accounting error. Configure this function if the accounting policy does not allow the deduction of the anti-jitter time or low traffic detection time from the online duration.

Notes

- The NAS needs to support anti-jitter or low traffic detection.
- A client logs out for the link is disconnected for a long time or the NAS detects its low traffic.
- When the jitter-off and low traffic detection functions are enabled, the first logout is accounted with jitter-off time only. For example, the jitter-off duration is set to 5 minutes and the low traffic detection duration is set to 10 minutes; if the client is disconnected from the network, the jitter-off function first triggers Web authentication to log the client out. In this case, only the 5-minute duration is deducted from the online duration in the accounting packet.

Configuration Steps

- Optional.
- Configure the accounting function.
- Configure jitter-off or low traffic detection.
- Configure jitter-off accounting.

Verification

- Simulate the scenario where a client goes online after authentication and then offline because the low traffic threshold is reached.
- Capture the stop-accounting packet sent by the NAS and check whether the time of low traffic detection is deducted from the online duration.

Related Commands

▾ Configuring Jitter-off Accounting

| | |
|------------------------------|--|
| Command | web-auth accounting jitter-off |
| Parameter Description | N/A |
| Command Mode | Global configuration mode |
| Usage Guide | Run this command to include the jitter-off duration or low traffic detection time into the online duration in the stop-accounting packet based on the server accounting policy. By default, they are not included. |

Configuration Example

▾ **Configuring Jitter-off Accounting**

| | |
|----------------------------|--|
| Configuration Steps | <ul style="list-style-type: none"> Configure jitter-off accounting. |
| | <pre>Ruijie(config)#web-auth accounting jitter-off</pre> |
| Verification | <ul style="list-style-type: none"> Check whether the configuration is successful. |
| | <pre>Ruijie(config)#show running-config ... web-auth accounting jitter-off ...</pre> |

1.4.29. Configuring the Portal Communication Port

Configuration Effect

- Configure the port (source port) used for the communication between the NAS and portal server.

Notes

- Only one port can be configured for the communication between the NAS and portal server.

Configuration Steps

- Configure a port as the portal communication port.

Verification

- After Web authentication is enabled, capture a packet on the portal server during the authentication process and check whether the source IP address of the packet is the IP address of the specified port.

Related Commands

▾ **Configuring the Portal Communication Port**

| | |
|------------------------------|--|
| Command | <code>ip portal source-interface interface-type interface-num</code> |
| Parameter Description | N/A |
| Command Mode | Global configuration mode |
| Usage Guide | N/A |

Configuration Example

▾ Configuring the Portal Communication Port

| | |
|----------------------------|---|
| Configuration Steps | <ul style="list-style-type: none"> Configure an aggregate port as the portal communication port. |
| | <pre>Ruijie(config)#ip portal source-interface Aggregateport 1</pre> |
| Verification | <ul style="list-style-type: none"> Check whether the configuration is successful. |
| | <pre>Ruijie(config)#show running-config ip portal source-interface Aggregateport 1</pre> |

1.4.30. Configuring a NDKEY-Compatible Webauth URL

Configuration Effect

- Configure the Webauth URL used in Web authentication to support the Shanghai NDKEY system.

Notes

- N/A

Configuration Steps

▾ Configuring a NDKEY-Compatible Webauth URL

- Set the post parameter in global configuration mode.

| | |
|------------------------------|---|
| Command | web-auth dkey-compatible url-parameter <i>string</i> |
| Parameter Description | <i>string</i> : Indicates the value of the post parameter. |
| Command Mode | Global configuration mode |
| Usage Guide | N/A |

Verification

- Execute redirection after the configuration and check that the redirection URL contains the post parameter.

Configuration Example

▾ Configuring Noise Reduction Suppression

| | |
|----------------------------|---|
| Configuration Steps | <ul style="list-style-type: none"> Configure compatibility parameters. |
| | <pre>Ruijie(config)#web-auth dkey-compatible url-parameter login</pre> |

| | |
|---------------------|--|
| Verification | <ul style="list-style-type: none"> ● Check whether the configuration is successful. |
| | <pre>Ruijie(config)#show running-config ... web-auth dkey-compatible url-parameter login</pre> |

1.4.31. Enabling NAT for Ruijie iPortal Web Authentication

Configuration Effect

- Configure Ruijie iPortal Web Authentication to support NAT.

Notes

- NAT takes effect only in Ruijie iPortal Web Authentication.

Configuration Steps

▾ Enabling NAT for Ruijie iPortal Web Authentication

- Enable NAT in global configuration mode.

| | |
|------------------------------|---------------------------|
| Command | iportal nat enable |
| Parameter Description | N/A |
| Command Mode | Global configuration mode |
| Usage Guide | N/A |

Verification

- Check whether Ruijie iPortal Web Authentication can be implemented after NAT is enabled.

Configuration Example

▾ Enabling NAT for Ruijie iPortal Web Authentication

| | |
|----------------------------|---|
| Configuration Steps | <ul style="list-style-type: none"> ● Enable NAT for Ruijie iPortal Web Authentication. |
| | <pre>Ruijie(config)#iportal nat enable</pre> |
| Verification | <ul style="list-style-type: none"> ● Check whether the configuration is successful. |

| | |
|----------------------------|---|
| Configuration Steps | <ul style="list-style-type: none"> Enable NAT for Ruijie iPortal Web Authentication. |
| | <pre>Ruijie(config)#iportal nat enable</pre> |
| Verification | <ul style="list-style-type: none"> Check whether the configuration is successful. |
| | <pre>Ruijie(config)#show running-config ... iportal nat enable</pre> |

1.4.32. Configuring the iPortal HTTP Retransmission Times

Configuration Effect

- Configure the iPortal HTTP retransmission times.

Notes

- The retransmission times configuration takes effect only for the HTTP connections pushed by an iPortal page.

Configuration Steps

▾ Configuring the iPortal HTTP Retransmission Times

- Set a parameter in global configuration mode.

| | |
|------------------------------|--|
| Command | <code>iportal retransmit count</code> |
| Parameter Description | <i>count</i> : Indicates the retransmission times. |
| Command Mode | Global configuration mode |
| Usage Guide | N/A |

Verification

- Send an iPortal Web authentication request and disconnect from the network. Check whether the NAS resends an HTTP connection request.

Configuration Example

▾ Configuring the Retransmission Times

| | |
|----------------------------|---|
| Configuration Steps | <ul style="list-style-type: none"> Configure the retransmission times. |
|----------------------------|---|

| | |
|---------------------|--|
| | <pre>Ruijie(config)#iportal retransmit 5</pre> |
| Verification | <ul style="list-style-type: none"> ● Check whether the configuration is successful. |
| | <pre>Ruijie(config)#show running-config ... iportal retransmit 5</pre> |

1.4.33. Configuring Service Selection in Ruijie iPortal Web Authentication

Configuration Effect

- Configure the service type used by Ruijie iPortal Web Authentication.

Notes

- N/A

Configuration Steps

▾ Configuring the Service Type Used by Ruijie iPortal Web Authentication

- Configure a service type in global configuration mode.

| | |
|---------------------|--|
| Command | <code>iportal service [internet <i>internet-name</i>] [local <i>local-name</i>]</code> |
| Parameter | <i>internet-name</i> : Indicates the external service name to be used. |
| Description | <i>local-name</i> : Indicates the internal service name to be used. |
| Command Mode | Global configuration mode |
| Usage Guide | N/A |

Configuration Example

▾ Configuring a Service Type

| | |
|----------------------------|--|
| Configuration Steps | <ul style="list-style-type: none"> ● Configure a service type. |
| | <pre>Ruijie(config)#iportal service local local-srv</pre> |
| Verification | <ul style="list-style-type: none"> ● Check whether the configuration is successful. |
| | <pre>Ruijie(config)#show running-config</pre> |

| | |
|----------------------------|--|
| Configuration Steps | <ul style="list-style-type: none"> Configure a service type. |
| | <pre>Ruijie(config)#iportal service local local-srv</pre> |
| Verification | <ul style="list-style-type: none"> Check whether the configuration is successful. |
| | <pre>... iportalservice local local-srv</pre> |

1.4.34. Configuring the Accounting Method List of Web Authentication

Configuration Effect

- Configure Web authentication accounting methods based on different templates.

Notes

- If no accounting method is configured for Web authentication, the default method is used.

Configuration Steps

▾ Configuring an Accounting Method

- Configure an accounting method in global or template configuration mode.

| | |
|------------------------------|--|
| Command | web-auth accounting v2 { default name } |
| Parameter Description | <i>name</i> : Indicates the name of the accounting method list to be used. |
| Command Mode | Global or template configuration mode |
| Usage Guide | N/A |

Verification

- View the destination IP address of accounting packets.

Configuration Example

▾ Configuring an Accounting Method

| | |
|----------------------------|---|
| Configuration Steps | <ul style="list-style-type: none"> Configure an accounting method. |
| | <pre>Ruijie(config.tmpl.eportalv2)#web-auth accounting v2 default</pre> |
| | |

| | |
|---------------------|--|
| Verification | <ul style="list-style-type: none"> ● Check whether the configuration is successful. |
| | <pre>Ruijie(config)#show running-config ... web-auth accounting v2 default</pre> |

1.4.35. Configuring a Web Authentication Method List

Configuration Effect

- Configure Web authentication methods based on different templates.

Notes

- If no Web authentication method is configured, the default method is used.

Configuration Steps

📌 Configuring a Web Authentication Method List

- Configure a Web authentication method in global or template configuration mode.

| | |
|------------------------------|--|
| Command | web-auth authentication v2 { default name } |
| Parameter Description | <i>name</i> : Indicates the name of the Web authentication method list to be used. |
| Command Mode | Global or template configuration mode |
| Usage Guide | N/A |

Verification

- View the destination IP address of authentication packets.

Configuration Example

📌 Configuring a Web Authentication Method

| | |
|----------------------------|--|
| Configuration Steps | <ul style="list-style-type: none"> ● Configure a Web authentication method. |
| | <pre>Ruijie(config.tmpl.eportalv2)#web-auth authentication v2 default</pre> |
| Verification | <ul style="list-style-type: none"> ● Check whether the configuration is successful. |
| | <pre>Ruijie(config)#show running-config</pre> |

| | |
|----------------------------|--|
| Configuration Steps | <ul style="list-style-type: none"> Configure a Web authentication method. |
| | <code>Ruijie(config.tmlt.eportalv2)#web-auth authentication v2 default</code> |
| Verification | <ul style="list-style-type: none"> Check whether the configuration is successful. |
| | <pre>... web-auth authentication v2 default</pre> |

1.4.36. Customizing a Page Suite

Configuration Effect

- Customize a webpage to display logos or advertisements in Ruijie iPortal Web Authentication.
- A single page suite supports two page sets to adapt to the screen sizes of STAs, for example, mobile STAs with a small screen.

Notes

- The preparation of a page suite must comply with the relevant specification; otherwise, the customized page suite cannot be used.
- The maximum number of files in a page suite (including the files displayed on PCs and mobile STAs) is 50, and the maximum length of the file name of each page is 32 bytes.
- A new page suite must be downloaded to the `./portal` directory and the name must not be the same as that of the default page suite; otherwise, the default page suite will be overwritten.
- Some NASs do not have a default page suite. When Ruijie iPortal Web Authentication is implemented, prepare a page suite in accordance with the relevant specification and import the page suite to the flash memory.

Verification

- Simulate the scenario where an STA connects to the Internet and opens the browser to perform authentication. Check that the customized page is displayed.

Related Commands

📄 Page File Naming Specification

| Page File Name (with an Extension) | Usage |
|------------------------------------|---|
| <code>login.htm</code> | Login page |
| <code>online.htm</code> | Online page (which is displayed when users pass authentication) |
| <code>offline.htm</code> | Offline page |

| | |
|--------------------|---|
| login_mobile.htm | Login page for mobile STAs |
| online_mobile.htm | Online page for mobile STAs (which is displayed when users pass authentication) |
| offline_mobile.htm | Offline page for mobile STAs |

📄 Login Page Preparation Specification

According to the page file naming specification, the file name of the login page for PCs is login.htm, and that for mobile STAs is login_mobile.htm. The login page content specification is described in the following.

- Form elements

The login page must contain a form, and the form submission method is fixed to POST. The PC login page is used as an example. Assume that the PC login page is stored in the **/portal** directory. The HTML code of the form is as follows (the HTML code of the form of the mobile STA login page is similar):

```
<form method="post" action="/portal/login.htm">
```

```
...
```

```
</form>
```

The form of the login page must contain the following page elements:

1. (Mandatory) **User name** text box: allows a user to enter the user name. The text box ID is username.
2. (Mandatory) **Password** text box: allows a user to enter the password (which is not displayed in plaintext mode). The text box ID is password.
3. (Mandatory) **Login** button: allows a user to submit a form using the POST method.
4. (Optional) Tab showing an authentication failure cause: The ID of the tab is errormsg. The tab is displayed on the login page to show why the current user fails authentication. When the login page is loaded, an error message request is sent using the GET method, and the request results will be displayed on the errormsg tab. You can configure whether to display the errormsg tab on the login page as required. The following script is used to request the error message content from the server (the script is only one example):

```
< script language="javascript">
```

```
//Request the error message content from the server.
```

```
function requestErrorMsg() {
```

```
    var _errmsg=document.getElementById("errmsg");
```

```
    var script=document.createElement("script");
```

```
script.src="errormessage"+location.search;
```

```
_errmsg.appendChild(script);
```

```
}
```

```
//Call the init function when the login page is loaded.
```

```
function init() {
.....
requestErrorMsg();
}
.....
</script>
```

- Form submission

A form is submitted in the format of `username=[AAAA]&password=[BBBB]&lang=[CCCC]`. The meanings of the fields are described in the following:

[AAAA]: (optional) Indicates the user name that the user enters in the **User name** text box.

[BBBB]: (optional) Indicates the password that the user enters in the **Password** text box.

[CCCC]: (optional) Indicates the language environment. The value **1** indicates Simplified Chinese, and the value **2** indicates English. Other languages are not defined. The default language environment is Simplified Chinese. When English is used, the submitted form must contain the language environment information; otherwise, the content of the `errmsg` tab is in Chinese.

The form of the login page must contain at least the following three input fields (tabs): **username**, **password**, and **Login** button. If the login page provides the Chinese and English language options, the form may also contain the **Language** input field, which is invisible.

The HTML source code of the login page is as follows:

```
<html>
<head>
<title>Web authentication login page</title>
</head>
<script language="javascript">
```

```
//Request errmsg. Errormsg is empty and not displayed when a user passes authentication or the login page is loaded for the first time.
```

```
function requestErrorMsg() {
var _errmsg=document.getElementById("errmsg");
var script=document.createElement("script");
script.src="errormessage"+location.search;
_errmsg.appendChild(script);
}
```

```
function init() {
```

```
.....
requestErrorMsg();
}

//Script that is executed when a user clicks the Login button
function login() {
    document.getElementById('loginForm').action = "./login.htm"+location.search;
    document.getElementById('loginForm').submit();
    window.onbeforeunload = null;
    window.onunload = null;
}
.....

</script>
<body onload="init()">
<form method="post" id="loginForm">
User name:<br>
<input type="text" name="username" accesskey="u" size="25" value="" id="usrename">
<br>
Password:<br>
<input type="password" name="password" accesskey="p" size="25"
    value="" id="password">
<br>
<input type="button" onclick="login()" value="Login" id="loginButton">
<input type="hidden" name="lang" value="" id="lan">
    <p name="errorMsg" id="errorMsg"></p>
</form>
</body>
</html>
```

The following figure shows the login page that the iPortal server pushes to users:

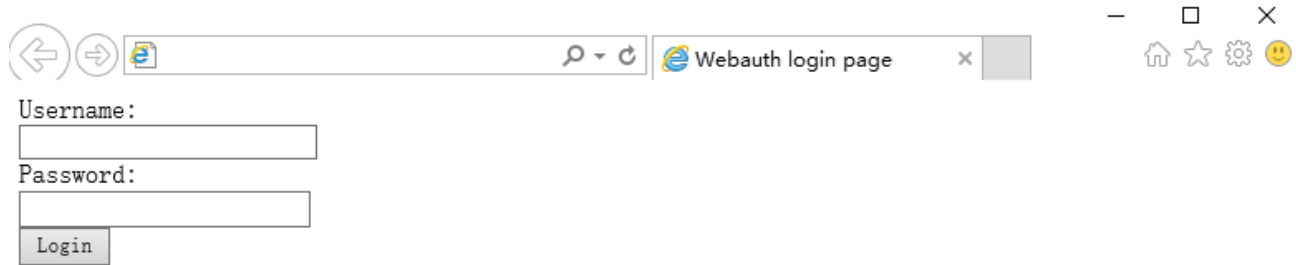

The login page shows only the mandatory elements. Other functions can be added. For example, you can add a background and set the styles of page elements.

▾ Online Page Preparation Specification

The online page is designed to inform a user that the user has passed authentication and can use network resources normally. The file name of the login page for PCs is **login.htm**, and that for mobile STAs is **login_mobile.htm**.

- Form elements

The online page must contain a form, which is used to submit an offline request. For this reason, the form must contain a **Logout** button. The form submission method is fixed to POST. The PC online page is used as an example. Assume that the PC online page is stored in the **/portal** directory. The HTML code of the form is as follows (the HTML code of the form of the mobile STA online page is similar):

```
<form method="post" action="/portal/online.htm">
```

```
...
```

```
</form>
```

The form of the online page must contain the following page elements:

(Optional) Tab with the username ID: displays the information of the online user.

(Optional) Tab with the userip ID: displays the IP address of the online user.

(Optional) Tab with the usermac ID: displays the MAC address of the online user.

(Optional) Tab with the ssid ID: displays the SSID of the online user.

(Optional) Tab with the availtime ID: displays the available time during which the user can access the Internet.

(Mandatory) Logout button: allows the user to go offline and requests the display of the offline page.

When the online page is loaded, a request is sent using the GET method to retrieve user information from the server, including the user name, IP address, MAC address, and associated SSID of the online user, and available time. The URI is `getonlineinfo`. The `onload` method of the body in the HTML code must be used. The following script is used to request user information from the server (the script is only one example):

```
<script language="javascript">
//Obtain the information of the online user, including the user name, IP address, MAC address, and associated SSID of the
online user, and available time.
    function requestOnlineInfo() {
        var _availTime=document.getElementById("availtime");
        var script=document.createElement("script");
        script.src="getonlineinfo"+location.search;
        _availTime.appendChild(script);
    }

    function init() {
        requestOnlineInfo();
    }
</script>
<body onload="init()">
.....
</body>
```

The HTML source code of the online page is as follows:

```
<html>
<head>
<title>Web authentication online page</title>
</head>
<script language="javascript">
//Obtain the information of the online user, including the user name, IP address, MAC address, and associated SSID of the
online user, and available time.
    function requestOnlineInfo() {
        var _availTime=document.getElementById("availtime");
        var script=document.createElement("script");
        script.src="getonlineinfo"+location.search;
        _availTime.appendChild(script);
    }

    function init() {
        requestOnlineInfo ();
    }
//Script that is executed when the user clicks the Logout button. The request URI is offline.htm.
```

```

function logout() {
    document.logoutform.action = "/offline.htm"+location.search;
    document.logoutform.submit();
    window.onbeforeunload = null;
    window.onunload = null;
}

</script>

<body onload="init()">
<form method="post" action="/portal/offline.htm" id="logoutform">
<input type="button" onclick="logout()" value="Logout" id="logoutButton">
</form>
    <table>
    <tr><td>User name:</td><td id="username"></td></tr>
    <tr><td>IP address:</td><td id="userip"></td></tr>
    <tr><td>MAC address:</td><td id="usermac"></td></tr>
    <tr><td>Associated SSID:</td><td id="ssid"></td></tr>
    <tr><td>Available time:</td><td id="availtime"></td></tr>
    </table>
</body>
</html>

```

The following figure shows the login page that the iPortal server pushes to users:

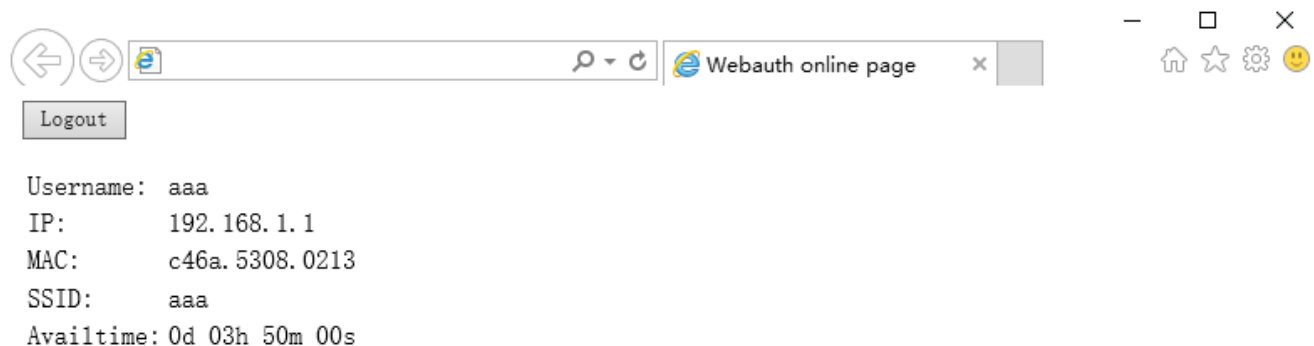

The login page shows only the mandatory elements. Other functions can be added. For example, you can add a background and set the styles of page elements.

Offline Page Preparation Specification

The offline page is displayed when a user clicks the **Logout** button on the online page. The offline page is designed to inform the user that the user logs out successfully. If the user needs to access the Internet after logout, the user must perform authentication. The file name of the offline page for PCs is **offline.htm**, and that for mobile STAs is **offline_mobile.htm**.

The offline page has the following elements:

1. (Optional) Tab with the timeused ID: displays the time that has used by the user to access the Internet.

When the offline page is loaded, a request is sent using the GET method to retrieve the used-time information from the server. The request URI is `getofflineinfo`. The `onload` method of the body in the HTML code must be used. To obtain the used-time information, you can create a dynamic script. For example, you can create `script.src="getofflineinfo"` to include the field information to be sent in the `src` of the script. The following script is used to request the used-time information from the server (the script is only one example):

```
<script language="javascript">
//Obtain the used time information.

function requestOfflineInfo() {
    var _timeused =document.getElementById("timeused");
        var script=document.createElement("script");
        script.src="getofflineinfo"+location.search;
        _timeused.appendChild(script);
    }

function init() {
    requestUserInfo();
}
</script>
<body onload="init()">
.....
</body>
```

The HTML source code of the offline page is as follows:

```
<html>
<head>
<title>Web authentication offline page</title>
</head>
<script language="javascript">
//Obtain the used time information.

function requestOfflineInfo() {
    var _timeused=document.getElementById("timeused");
```



```

        var script=document.createElement("script");

        script.src="getofflineinfo"+location.search;

        _timeused.appendChild(script);

    }

    function init() {
        requestOfflineInfo();
    }
</script>

<body onload="init()">
Logout succeeded<br>
    <table>
    <tr><td>Used time:</td><td id="timeused"></td></tr>
    </table>
</body>
</html>

```

The following figure shows the offline page that the iPortal server pushes to users:



The offline page shows only the mandatory elements. Other functions can be added. For example, you can add a background and set the styles of page elements.

▾ Page Compression Specification

After you prepare the login page, online page, and offline page in accordance with the specification described above, you need to compress the pages and related elements and upload them to the NAS. Then you can apply the page suite. The page compression specification is as follows:

1. Compress the prepared pages and related element files (such as image files and style sheet files) into a **.zip** package, for example, **portal1_page.zip**.
2. You can create directories in a page suite. For example, the **portal1_page.zip** package shown in the following figure has the **style** directory, which contains the CSS files of pages and other image files.

| | | |
|--------------------------|----------|----------|
| ..(上层目录) | | |
| style | 81.28 KB | 60.69 KB |
| check_offline.htm | 9.81 KB | 3.34 KB |
| offline.htm | 6.40 KB | 2.65 KB |
| online.htm | 13.13 KB | 4.14 KB |
| login.htm | 11.79 KB | 3.90 KB |
| check_offline_mobile.htm | 9.38 KB | 3.22 KB |
| login_mobile.htm | 10.39 KB | 3.21 KB |
| online_mobile.htm | 13.96 KB | 3.91 KB |
| favicon.ico | 1 KB | 1 KB |
| offline_mobile.htm | 5.09 KB | 2.01 KB |

After you compress the pages into a page suite, use TFTP or other tools to upload the page suite to the **/portal/zip/** directory of the flash memory on the NAS. Then configure the portal server to use the page suite (that is, associate the portal server with the page suite). For details, see the configuration manual related to Web authentication. A directory named after the page suite package is created in the **/portal/ext_zip/** directory of the flash memory. For example, if the page suite package is named **portal1_page.zip**, the **/portal/ext_zip/portal1_page/** directory of the flash memory is created, and the package is automatically decompressed in the directory. The portal server can push Web authentication pages to users based on the page suite.

Configuration Example

Customizing a Page Suite

| | |
|----------------------------|--|
| Configuration Steps | <ul style="list-style-type: none"> ● Customize a page suite. |
| | <pre>Ruijie(config.tmpl.t.portal)#page-suit ruijiepage</pre> |
| Verification | <ul style="list-style-type: none"> ● Check whether the configuration is successful. |
| | <pre>Ruijie#show web-auth template Webauth Template Settings: ----- Name: portal Page-suit: ruijiepage Advertising url: default</pre> |

| | |
|----------------------------|--|
| Configuration Steps | <ul style="list-style-type: none"> Customize a page suite. |
| | <pre>Ruijie(config.tmlt.iportal)#page-suit ruijiepage</pre> |
| Verification | <ul style="list-style-type: none"> Check whether the configuration is successful. |
| | <pre>Advertising mode: online-popup Type: Intral Portal Acctmlist:default Authmlist:default</pre> |

1.4.37. Upgrade Compatibility

Configuration Effect

- Some configuration commands are optimized in the 11.X series software and the command formats are changed. For details, see the subsequent description.
- The 10.X series software supports smooth upgrade without function loss. However, some commands are displayed in new formats after upgrade.
- When you run the commands in earlier formats in the **no** form in the 11.X series software, a message is displayed, indicating the **no** form is not supported. You need to perform the **no** operation in new command formats.

Configuration Steps

- It is recommended that you run commands in new formats.

Verification

- Check that function loss does not occur when the 10.X series software is upgraded to the 11.X series software, and commands are displayed and stored in new formats.
- The commands in new formats have the same functions as the commands in earlier formats.

Related Commands

📄 [Configuring the IP Address of the Portal Server in Ruijie First-Generation Web Authentication](#)

| | |
|------------------------------|---|
| Command | http redirect <i>ip-address</i> |
| Parameter Description | <i>ip address</i> : Indicates the ip address of the ePortal server in Ruijie First-Generation Web Authentication. |
| Command Mode | Global configuration mode |
| Usage Guide | In the 11.X version, the command is converted into an eportalv1 template, and the ip command in template configuration mode is executed to configure and display the IP address of the portal server. For details, see |

| |
|---|
| section 1.4.1 "Configuring Ruijie First-Generation Web Authentication." |
|---|

↘ Configuring the Portal Server

| | |
|------------------------------|---|
| Command | portal-server [eportal1 eportalv2] |
| Parameter Description | eportav1 : Indicates the information of the portal server used in Ruijie First-Generation Web Authentication. eportav2 : Indicates the information of the portal server used in Ruijie Second-Generation Web Authentication. |
| Command Mode | Global configuration mode |
| Usage Guide | In the 11.X version, the command is converted into an eportalv1 or eportalv2 template, and relevant information is filled in. The main parameters of the portal server include the IP address and URL of the server. The original command will be replaced by the ip command and url command in the template. |

↘ Configuring Web Authentication Control on a Port

| | |
|------------------------------|--|
| Command | web-auth port-control |
| Parameter Description | N/A |
| Command Mode | Interface configuration mode |
| Usage Guide | In the 11.X version, the command is converted into web-auth enable <type> , in which type specifies the type (first or second generation) of Web authentication. The default type is Ruijie First-Generation Web Authentication. |

↘ Configuring the IP-Only Binding Mode

| | |
|------------------------------|---|
| Command | web-auth port-control ip-only-mode |
| Parameter Description | N/A |
| Command Mode | Interface configuration mode |
| Usage Guide | In the 11.X version, the command is converted into an eportalv1 or eportalv2 template, depending on the actual configuration. The server binding mode is configured and displayed by using the bindmode command in template configuration mode. For details, see section 1.4.1 "Configuring Ruijie First-Generation Web Authentication" and section 1.4.2 "Configuring Ruijie Second-Generation Web Authentication." |

↘ Configuring VLAN-Based Web Authentication

| | |
|------------------------------|--|
| Command | web-auth allow-vlan <i>list</i> |
| Parameter Description | <i>list</i> : Indicates the list of VLANs for which Web authentication is enabled. |
| Command Mode | Global configuration mode |

| | |
|--------------------|---|
| Usage Guide | In the 11.X version, the command is converted into a command used to configure VLAN-based SCC authentication exemption. |
|--------------------|---|

▾ Displaying the Configuration Information of Ruijie First-Generation Web Authentication

| | |
|------------------------------|--|
| Command | show http redirect |
| Parameter Description | N/A |
| Command Mode | Privileged mode |
| Usage Guide | In the 11.X version, the command is unavailable and changed to show web-auth template . |

▾ Displaying the Port Control Information

| | |
|------------------------------|---|
| Command | show web-auth port-control |
| Parameter Description | N/A |
| Command Mode | Privileged mode |
| Usage Guide | In the 11.X version, the command is unavailable and changed to show web-auth control . |

Configuration Example

▾ Configuring Ruijie First-Generation Web Authentication

| | |
|----------------------------|--|
| Configuration Steps | <ul style="list-style-type: none"> Check that the NAS runs on the 10.X version and is configured with the IP address of the portal server used by Ruijie First-Generation Web Authentication. |
| | <pre>Ruijie(config)# http redirect 192.168.197.64</pre> |
| | <ul style="list-style-type: none"> Upgrade the NAS to 11.X. |
| Verification | <ul style="list-style-type: none"> Run the show running-config command after the upgrade and check whether the new command formats are used. |
| | <pre>Ruijie#sh running-config web-auth template eportalvl Ip 192.168.197.64 !</pre> |

1.4.38. Configuring Noise Reduction in Wireless Web Authentication

Configuration Effect

- When the number of times an STA accesses an IP address reaches the configured threshold, the subsequent packets that the STA sends to the IP address will be dropped, in order to realize noise reduction.

Notes

- Configure the two parameters (aging time and hit times) for noise reduction based on the network condition and actual requirements to avoid the dropping of normal packets, which will affect redirection.

Configuration Steps

▾ Configuring Noise Reduction in Global Configuration Mode

| | |
|---------------------|--|
| Command | web-auth noise[aging <i>agmin</i>] [hit <i>times</i>] |
| Parameter | <i>agmin</i> : Indicates the aging time of noise reduction. The default value is 1 minute. |
| Description | <i>times</i> : Is a rule of noise reduction. When the number of times an STA accesses an IP address reaches the threshold specified by the <i>times</i> parameter, noise is considered to occur. The default value is 3 (times). |
| Command Mode | Global configuration mode |
| Usage Guide | N/A |

Verification

- Simulate the scenario where an STA accesses an IP address repeatedly during redirection until the maximum number of access times is reached. Check whether the subsequent packets that the STA sends to the IP address are redirected or not. After the aging time of the noise reduction has elapsed, check whether the packets that the STA sends to the IP address are redirected again.

Configuration Example

▾ Configuring Noise Reduction in Wireless Web Authentication

| | |
|----------------------------|--|
| Configuration Steps | <ul style="list-style-type: none"> ● Set the parameters of noise reduction in wireless Web authentication. <pre>Ruijie(config)#web-auth noise aging 1 hit 3</pre> |
| Verification | <ul style="list-style-type: none"> ● Check whether the configuration is successful. <pre>Ruijie(config)#show running-config</pre> |

1.4.39. Enabling iOS Automatic Pop-up Window Control in WeChat-Based Authentication

Configuration Effect

- Enable iOS STAs to support the automatic display of pop-up windows and display Wi-Fi signal reception during WeChat-based authentication (including WeChat follow-up authentication and WeChat-based Wi-Fi connection authentication). (iOS STAs can use the WeChat app without login when the WeChat traffic straight-through function is enabled.)

Notes

- iOS automatic pop-up window control must be used together with the WeChat traffic straight-through function (run the `web-ctrl free-auth weixin` command to enable this function).
- The redirection performance will be reduced after iOS automatic pop-up window control is enabled.
- iOS automatic pop-up window control will be invalid when the straight-through function is enabled for the Apple Inc. website by running the following commands:
- `web-ctrl free-auth iphone`
- `web-auth acl white-url http://www.apple.com.cn`
- `web-auth acl white-url http://captive.apple.com`

Configuration Steps

✚ Enabling iOS Automatic Pop-up Window Control in Global Configuration Mode

| | |
|---------------------|--|
| Command | <code>http redirect adapter ios</code> |
| Parameter | N/A |
| Description | |
| Command Mode | Global configuration mode |
| Usage Guide | N/A |

Verification

- Check that iOS STAs show pop-up windows and display Wi-Fi signal reception during WeChat-based authentication (including WeChat follow-up authentication and WeChat-based Wi-Fi connection authentication). (iOS STAs can use the WeChat app without login when the WeChat traffic straight-through function is enabled.)

Configuration Example

✚ Enabling iOS Automatic Pop-up Window Control in WeChat-Based Authentication

| | |
|----------------------------|---|
| Configuration Steps | <ul style="list-style-type: none"> ● Enable iOS automatic pop-up window control. <pre>Ruijie(config)#http redirect adapter ios</pre> |
| Verification | <ul style="list-style-type: none"> ● Check whether the configuration is successful. <pre>Ruijie(config)#show running-config</pre> |

1.4.40. Enabling the Smart WeChat Web Authentication

Configuration Effect

- When an STA is associated with an SSID for the second time during WeChat Web authentication (including WeChat follow-up authentication and WeChat-based Wi-Fi connection authentication), the STA gets online without authentication.

Notes

- You need to run the ip dhcp snooping command before the smart authentication function takes effect.

Configuration Steps

📌 Configuring the Smart Authentication in Global Configuration Mode

| | |
|------------------------------|---------------------------------------|
| Command | web-auth sta-perception enable |
| Parameter Description | N/A |
| Command Mode | Global configuration mode |
| Usage Guide | N/A |

Verification

- Simulate the scenario where an STA is associated with an SSID for the second time during WeChat Web authentication (including WeChat follow-up authentication and WeChat-based Wi-Fi connection authentication). Check whether the STA gets online without authentication.

Configuration Example

📌 Enabling the Smart WeChat Web Authentication

| | |
|----------------------------|--|
| Configuration Steps | <ul style="list-style-type: none"> ● Enable the smart WeChat Web authentication. ● The configuration is optional. <pre>Ruijie(config)#web-auth sta-perception enable</pre> |
| Verification | <ul style="list-style-type: none"> ● Check whether the configuration is successful. <pre>Ruijie(config)#show running-config</pre> |

1.4.41. Configuring User Detection Under WLANSEC

Configuration Effect

- After online user detection under WLANSEC is configured, if the traffic of a user is lower than the threshold within a specified interval, the device automatically forces the user to go offline, to prevent economic loss for the user due to continuous charging.

Notes

- The function has the same effect as the SCC command executed in global configuration mode: **offline-detect interval** *interval* threshold *threshold*. The configuration of user detection under WLANSEC has a higher priority than the SCC command executed in global configuration mode.

Configuration Steps

- (Optional) By default, a user is forced to go offline if there is no traffic of the user within 15 minutes.
-
- If **flow** is set to **0**, traffic detection is not performed.
 - By default, traffic detection under WLANSEC is disabled in 10.X version and the global configuration is used. After the version is upgraded to 11.X, traffic detection under WLANSEC needs to be manually disabled.
-

Verification

- After online user detection is configured, enable a user to go online, shut down the specified authenticated terminal, and wait for the specified interval to elapse. Then, run the **show web user** command on the device to check that the user has gone offline.

Related Commands

↳ Configuring User Detection Under WLANSEC

| | |
|------------------------------|---|
| Command | web-auth offline-detect interval <i>interval</i> flow <i>threshold</i> no web-auth offline-detect default web-auth offline-detect |
| Parameter Description | <i>interval</i> : Indicates the offline detection interval. The value ranges from 1 min to 65535 min. The default value is 15 min. <i>threshold</i> : Indicates the traffic threshold. The value ranges from 0 bytes to 4294967294 bytes. The default value is 0, indicating that traffic detection is not performed. no web-auth offline-detect : Disables online user detection. default web-auth offline-detect : Restore the default value. That is, authenticated online users are forced to go offline if their traffic is zero within 15 min. |
| Defaults | 15 min |
| Command Mode | WLANSEC configuration mode |
| Usage Guide | This command can be used to configure the online keepalive time for users. Authenticated online users are forced to go offline if their traffic is lower than the specified threshold within a specified interval. |

Configuration Example

📌 Configuring User Detection Under WLANSEC

| | |
|----------------------------|---|
| Configuration Steps | <ul style="list-style-type: none"> Set user detection under WLANSEC 1. |
| | <pre>Ruijie(config)#wlansec 1 Ruijie(config-wlansec)#web-auth offline-detect interval 30 flow 10000</pre> |
| Verification | <ul style="list-style-type: none"> Check whether the configuration is successful. |
| | <pre>Ruijie(config)#show running-config be wlansec 1 wlansec 1 web-auth offline-detect interval 30 flow 10000 ...</pre> |

1.4.42. Configuring Transparent Transmission of the 0x05 Attribute of the Portal Protocol

Configuration Effect

- Configure transparent transmission of the 0x05 attribute of the portal protocol. After this function is enabled, the Web authentication server supports transparent transmission of the 0x05 attribute in the following scenarios:
 - When the portal protocol of China Mobile is interworked, the Web authentication server encapsulates the error flag into the 0x05 attribute (ErrID) and transparently transmits it to the portal server.
 - When Huawei portal protocol 2.0 is interworked, the Web authentication server encapsulates prompts from third-party authentication device such as the RADIUS server to the 0x05 attribute (TextInfo) and transparently transmits them to the portal server.

Notes

- This function is disabled by default.

Configuration Steps

- Optional.
- Configure this function when the ErrID (0x05) attribute specified in the portal protocol of China Mobile is required.
- Configure this function when the TextInfo (0x05) attribute specified in Huawei portal protocol 2.0 is required.

Related Commands

📌 Configuring Transparent Transmission of the 0x05 Attribute of the Portal Protocol in Global Configuration Mode

| | |
|----------------|------------------------------------|
| Command | web-auth portal-attribute 5 |
|----------------|------------------------------------|

| | |
|------------------------------|---|
| Parameter Description | N/A |
| Command Mode | Global configuration mode |
| Usage Guide | In general, enable this function on the portal server when a device needs to upload the error flag (ErrID). |
| Command | web-auth portal-attribute textinfo |
| Parameter Description | N/A |
| Command Mode | Global configuration mode |
| Usage Guide | In general, enable this function on the portal server (using Huawei portal protocol 2.0) when a device needs to upload prompts (TextInfo) from a third-party authentication device such as the RADIUS server. |

Verification

- After this function is enabled, check that the 0x05 attribute is contained in the ACK packet responded to the portal server.

Configuration Example

Configuring Transparent Transmission of the 0x05 Attribute of the Portal Protocol

| | |
|----------------------------|---|
| Configuration Steps | <ul style="list-style-type: none"> Configure transparent transmission of the 0x05 attribute. <pre>Ruijie(config)# web-auth portal-attribute 5</pre> <p>Or:</p> <pre>Ruijie(config)# web-auth portal-attribute textinfo</pre> |
| Verification | <ul style="list-style-type: none"> Check whether the configuration is successful. <pre>Ruijie(config)#show running-config</pre> |

1.4.43. Configuring Uniqueness Check of Portal Authentication Accounts

Configuration Effect

- Configure the uniqueness check of portal authentication accounts. After this function is enabled, the Web authentication server checks account information in the user authentication request. If finding that the account has been used by another user and is online, the Web authentication server directly responds to the portal server with ErrCode

2-contained ACK_AUTH. After receiving such response, some portal servers push the "Terminal Preemption" prompt to users.

Notes

- This function is disabled by default.

Configuration Steps

- Optional.
- Configure the function when the portal server needs to push the "Terminal Preemption" prompt to users.

Related Commands

▾ Configuring Uniqueness Check of Portal Authentication Accounts in Global Configuration Mode

| | |
|---------------------|--|
| Command | <code>web-auth portal-valid unique-name</code> |
| Parameter | N/A |
| Description | |
| Command Mode | Global configuration mode |
| Usage Guide | In general, configure the function when the portal server needs to push the "Terminal Preemption" prompt to users. |

Verification

- After this function is enabled, if finding that a same account is used by another user and is online, the Web authentication server directly responds to the portal server with ErrCode 2-contained ACK_AUTH.

Related Commands

▾ Configuring Uniqueness Check of Portal Authentication Accounts

| | |
|----------------------------|--|
| Configuration Steps | <ul style="list-style-type: none"> ● Configure uniqueness check of portal authentication accounts. <pre>Ruijie(config)# web-auth portal-valid unique-name</pre> |
| Verification | <ul style="list-style-type: none"> ● Check whether the configuration is successful. <pre>Ruijie(config)#show running-config</pre> |
| | |

1.4.44. Enabling the One-click Switch Configuration via WiFiDog

Configuration Effect

- Use one command to configure WiFiDog template information, port control, global survival, iOS window display, and imperceptible authentication.

Notes

- The **no** form of this command can delete template information and controlled ports, but is not globally valid.

Configuration Steps

↳ Enabling the One-click Switch Configuration via WiFiDog

- Optional.

| | |
|------------------------------|---|
| Command | web-auth wifidog-template <i>name</i> interface [Aggregateport TenGigabitEthernet] <i>intf</i> portal-ip <i>portal-ip-addr</i> nas-ip <i>nas-ip-addr</i> url <i>url-string</i> [escape ios-adapter perception] |
| Parameter Description | <i>name</i> : Indicates the template name. <i>intf</i> : Indicates the controlled interface. <i>portal-ip-addr</i> : Indicates the IP address of the portal server. <i>nas-ip-addr</i> : Sets the IP address for a device with WiFiDog configured to access a service, so that the server sends packets to this IP address for communication. <i>url-string</i> : Indicates the URL for portal server authentication. |
| Command Mode | Global configuration mode |
| Usage Guide | The one-click configuration function can control only one port at a time. To control multiple ports, perform one-click configuration for the required times. The no form of this command can delete template information and all the controlled ports, but is not globally valid. |

Verification

- Run the **Show run** command to check whether the configuration is normal.

Configuration Example

↳ Enabling the One-click Switch Configuration via WiFiDog

| | |
|----------------------------|--|
| Configuration Steps | <ul style="list-style-type: none"> ● Enable the one-click switch configuration via WiFiDog. |
| | <pre>Ruijie(config)# web-auth wifidog-template aaa interface tenGigabitEthernet 3/2 portal-ip 172.21.6.78 nas-ip 192.168.197.227 url http://172.21.6.78/auth/wifidogAuth</pre> |
| Verification | <ul style="list-style-type: none"> ● Run the show running-config command to check whether the configuration is successful. |

1.4.45. Enabling the One-click Switch Configuration via WeChat

Configuration Effect

- Use one command to configure WeChat template information, port control, global survival, PC free authentication, iOS window display, and imperceptible authentication.

Notes

- The **no** form of this command can delete template information and controlled ports, but is not globally valid.

Configuration Steps

↳ Enabling the One-click Switch Configuration via WeChat

- Optional.

| | |
|------------------------------|---|
| Command | web-auth wechat-template <i>name</i> interface [Aggregateport TenGigabitEthernet] <i>intf</i> portal-ip <i>portal-ip-addr</i> nas-ip <i>nas-ip-addr</i> [escape free-pc ios-adapter perception] |
| Parameter Description | <i>name</i> : Indicates the template name. <i>intf</i> : Indicates the controlled interface. <i>portal-ip-addr</i> : Indicates the IP address of the portal server. <i>nas-ip-addr</i> : Sets the IP address for a device with WeChat configured to access a service, so that the server sends packets to this IP address for communication. |
| Command Mode | Global configuration mode |
| Usage Guide | The one-click configuration function can control only one port at a time. To control multiple ports, perform one-click configuration for the required times. The no form of this command can delete template information and all the controlled ports, but is not globally valid. |

Verification

- Run the **Show run** command to check whether the configuration is normal.

Configuration Example

↳ Enabling the One-click Switch Configuration via WeChat

| | |
|----------------------------|--|
| Configuration Steps | <ul style="list-style-type: none"> ● Enable the one-click switch configuration via WeChat. |
| | <pre>Ruijie(config)# web-auth wechat-template aaa interface tenGigabitEthernet 3/2 portal-ip 172.21.6.78 nas-ip 192.168.197.227</pre> |
| Verification | <ul style="list-style-type: none"> ● Run the show running-config command to check whether the configuration is successful. |

1.5. Monitoring

Clearing

| Description | Command |
|---|---|
| Forces users offline. | clear web-auth user { all ip <i>ip-address</i> mac <i>mac-address</i> name <i>name-string</i> session-id <i>num</i> } |
| Clears all the straight-through network resources. | clear web-auth direct-site |
| Clears all the authentication-exempted users. | clear web-auth direct-host |
| Clears the Webauth blacklist and whitelist configuration. | clear web-auth acl |

Displaying

| Description | Command |
|--|---|
| Displays the Webauth blacklist and whitelist configuration. | show web-auth acl |
| Displays the basic parameters of Web authentication. | show web-auth parameter |
| Displays the Webauth template configuration. | show web-auth template |
| Displays the authentication-exempted host range. | show web-auth direct-host |
| Displays the straight-through address range. | show web-auth direct-site |
| Displays the straight-through ARP range. | show web-auth direct-arp |
| Displays the TCP interception port. | show web-auth rdport |
| Displays the Webauth configuration on a port. | show web-auth control |
| Displays the online information of all users or specified users. | show web-auth user { all ip <i>ip-address</i> <i>ipv6-address</i> mac <i>mac-address</i> name <i>name-string</i> } |
| Displays the Webauth CGI configuration. | show web-auth cgi |
| Displays the basic global Webauth information. | show web-auth global |
| Displays the global Webauth template. | show web-auth global authentication |
| Displays the customized Webauth page suite. | show web-auth global customized-pages |
| Displays the iPortal server information. | show web-auth global local-portal |

| Description | Command |
|---|--|
| Displays the global Webauth template. | show web-auth global template |
| Displays the global Webauth type. | show web-auth global webauth-type |
| Displays the Webauth configuration. | show web-auth info |
| Displays the iPortal Webauth information. | show web-auth local-portal |
| Displays the Webauth portal check information. | show web-auth portal-check |
| Displays the noise reduction configuration of Web authentication. | show web-auth noise |

Debugging



System resources are occupied when debugging information is output. Disable the debugging switch immediately after use.

| Description | Command |
|----------------------------|---------------------------|
| Debugs Web authentication. | debug web-auth all |

2 Configuring AAA

2.1 Overview

Authentication, authorization, and accounting (AAA) provides a unified framework for configuring the authentication, authorization, and accounting services. Ruijie Networks devices support the AAA application.

AAA provides the following services in a modular way:

Authentication: Refers to the verification of user identities for network access and network services. Authentication is classified into local authentication and authentication through Remote Authentication Dial In User Service (RADIUS) and Terminal Access Controller Access Control System+ (TACACS+).

Authorization: Refers to the granting of specific network services to users according to a series of defined attribute-value (AV) pairs. The pairs describe what operations users are authorized to perform. AV pairs are stored on network access servers (NASs) or remote authentication servers.

Accounting: Refers to the tracking of the resource consumption of users. When accounting is enabled, NASs collect statistics on the network resource usage of users and send them in AV pairs to authentication servers. The records will be stored on authentication servers, and can be read and analyzed by dedicated software to realize the accounting, statistics, and tracking of network resource usage.

AAA is the most fundamental method of access control. Ruijie Networks also provides other simple access control functions, such as local username authentication and online password authentication. Compared to them, AAA offers higher level of network security.

AAA has the following advantages:

- Robust flexibility and controllability
- Scalability
- Standards-compliant authentication
- Multiple standby systems

2.2 Applications

| Application | Description |
|--|---|
| Configuring AAA in a Single-Domain Environment | AAA is performed for all the users in one domain. |
| Configuring AAA in a Multi-Domain Environment | AAA is performed for the users in different domains by using different methods. |

2.2.1 Configuring AAA in a Single-Domain Environment

Scenario

In the network scenario shown in Figure 2-1, the following application requirements must be satisfied to improve the security management on the NAS:

1. To facilitate account management and avoid information disclosure, each administrator has an individual account with different username and password.
2. Users must pass identity authentication before accessing the NAS. The authentication can be in local or centralized mode. It is recommended to combine the two modes, with centralized mode as active and local mode as standby. As a result, users must undergo authentication by the RADIUS server first. If the RADIUS server does not respond, it turns to local authentication.
3. During the authentication process, users can be classified and limited to access different NASs.
4. Permission management: Users managed are classified into Super User and Common User. Super users have the rights to view and configure the NAS, and common users are only able to view NAS configuration.
5. The AAA records of users are stored on servers and can be viewed and referenced for auditing. (The TACACS+ server in this example performs the accounting.)

Figure 2-1

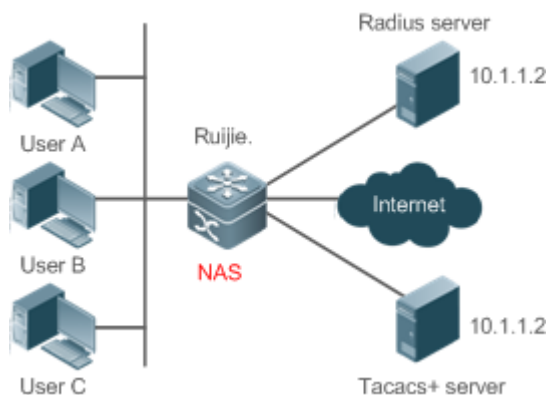

Remarks

User A, User B, and User C are connected to the NAS in wired or wireless way.
 The NAS is an access or convergence switch.
 The RADIUS server can be the Windows 2000/2003 Server (IAS), UNIX system component, and dedicated server software provided by a vendor.
 The TACACS+ server can be the dedicated server software provided by a vendor.

Deployment

- Enable AAA on the NAS.
- Configure an authentication server on the NAS.
- Configure local users on the NAS.
- Configure the authentication service on the NAS.

- Configure the authorization service on the NAS.
- Configure the accounting service on the NAS.

2.2.2 Configuring AAA in a Multi-Domain Environment

Scenario

Configure the domain-based AAA service on the NAS.

- A user can log in by entering the username PC1@ruijie.net or PC2@ruijie.com.cn and correct password on an 802.1X client.
- Permission management: Users managed are classified into Super User and Common User. Super users have the rights to view and configure the NAS, and common users are only able to view NAS configuration.
- The AAA records of users are stored on servers and can be viewed and referenced for auditing.

Figure 2-2

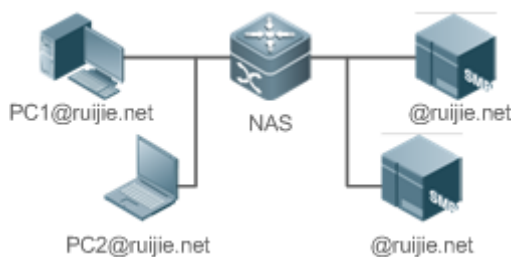

| | |
|----------------|--|
| Remarks | <p>The clients with the usernames PC1@ruijie.net and PC2@ruijie.com.cn are connected to the NAS in wired or wireless way.</p> <p>The NAS is an access or convergence switch.</p> <p>The Security Accounts Manager (SAM) server is a universal RADIUS server provided by Ruijie Networks.</p> |
|----------------|--|

Deployment

- Enable AAA on the NAS.
- Configure an authentication server on the NAS.
- Configure local users on the NAS.
- Define an AAA method list on the NAS.
- Enable domain-based AAA on the NAS.
- Create domains and AV sets on the NAS.

2.3 Features

Basic Concepts

Local Authentication and Remote Server Authentication

Local authentication is the process where the entered passwords are verified by the database on the NAS.

Remote server authentication is the process where the entered passwords are checked by the database on a remote server. It is mainly implemented by the RADIUS server and TACACS+ server.

Method List

AAA is implemented using different security methods. A method list defines a method implementation sequence. The method list can contain one or more security protocols so that a standby method can take over the AAA service when the first method fails. On Ruijie devices, the first method in the list is tried in the beginning and then the next is tried one by one if the previous gives no response. This method selection process continues until a security method responds or all the security methods in the list are tried out. Authentication fails if no method in the list responds.

A method list contains a series of security methods that will be queried in sequence to verify user identities. It allows you to define one or more security protocols used for authentication, so that the standby authentication method takes over services when the active security method fails. On Ruijie devices, the first method in the list is tried in the beginning and then the next is tried one by one if the previous gives no response. This method selection process continues until a method responds or all the methods in the method list are tried out. Authentication fails if no method in the list responds.

! The next authentication method proceeds on Ruijie devices only when the current method does not respond. When a method denies user access, the authentication process ends without trying other methods.

Figure 2-3

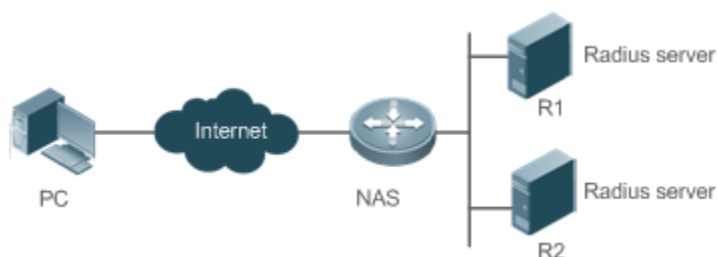



Figure 2-3 shows a typical AAA network topology, where two RADIUS servers (R1 and R2) and one NAS are deployed. The NAS can be the client for the RADIUS servers.

Assume that the system administrator defines a method list, where the NAS selects R1 and R2 in sequence to obtain user identity information and then accesses the local username database on the server. For example, when a remote PC user initiates dial-up access, the NAS first queries the user's identity on R1. When the authentication on R1 is completed, R1 returns an Accept response to the NAS. Then the user is permitted to access the Internet. If R1 returns a Reject response, the user is denied Internet access and the connection is terminated. If R1 does not respond, the NAS considers that the R1 method times out and continues to query the user's identity on R2. This process continues as the NAS keeps trying the remaining authentication methods, until the user request is authenticated, rejected, or terminated. If all the authentication methods are responded with Timeout, authentication fails and the connection will be terminated.

i The Reject response is different from the Timeout response. The Reject response indicates that the user does not meet the criteria of the available authentication database and therefore fails in authentication, and the Internet access request is denied. The Timeout response indicates that the authentication server fails to respond to the identity query.

When detecting a timeout event, the AAA service proceeds to the next method in the list to continue the authentication process.

-  This document describes how to configure AAA on the RADIUS server. For details about the configuration on the TACACS+ server, see the *Configuring TACACS+*.

AAA Server Group

You can define an AAA server group to include one or more servers of the same type. If the server group is referenced by a method list, the NAS preferentially sends requests to the servers in the referenced server group when the method list is used to implement AAA.

VRF-Enabled AAA Group

Virtual private networks (VPNs) enable users to share bandwidths securely on the backbone networks of Internet service providers (ISPs). A VPN is a site set consisting of shared routes. An STA site connects to the network of an ISP through one or multiple interfaces. AAA supports assigning a VPN routing forwarding (VRF) table to each user-defined server group.

When AAA is implemented by the server in a group assigned with a VRF table, the NAS sends request packets to the remote servers in the server group. The source IP address of request packets is an address selected from the VRF table according to the IP addresses of the remote servers.

If you run the **ip radius/tacacs+ source-interface** command to specify the source interface for the request packets, the IP address obtained from the source interface takes precedence over the source IP address selected from the VRF table.

Overview

| Feature | Description |
|------------------------------------|--|
| AAA Authentication | Verifies whether users can access the Internet. |
| AAA Authorization | Determines what services or permissions users can enjoy. |
| AAA Accounting | Records the network resource usage of users. |
| Multi-Domain AAA | Creates domain-specific AAA schemes for 802.1X stations (STAs) in different domains. |

2.3.1 AAA Authentication

Authentication, authorization, and accounting are three independent services. The authentication service verifies whether users can access the Internet. During authentication, the username, password, and other user information are exchanged between devices to complete users' access or service requests. You can use only the authentication service of AAA.

-  To configure AAA authentication, you need to first configure an authentication method list. Applications perform authentication according to the method list. The method list defines the types of authentication and the sequence in which they are performed. Authentication methods are implemented by specified applications. The only exception is the default method list. All applications use the default method list if no method list is configured.

AAA Authentication Scheme

- No authentication (**none**)

The identity of trusted users is not checked. Normally, the no-authentication (None) method is not used.

- Local authentication (**local**)

Authentication is performed on the NAS, which is configured with user information (including usernames, passwords, and AV pairs). Before local authentication is enabled, run the **username password/secret** command to create a local user database.

- Remote server group authentication (**group**)

Authentication is performed jointly by the NAS and a remote server group through RADIUS or TACACS+. A server group consists of one or more servers of the same type. User information is managed centrally on a remote server, thus realizing multi-device centralized and unified authentication with high capacity and reliability. You can configure local authentication as standby to avoid authentication failures when all the servers in the server group fail.

AAA Authentication Types

Ruijie products support the following authentication types:

- Login authentication

Users log in to the command line interface (CLI) of the NAS for authentication through Secure Shell (SSH), Telnet, and File Transfer Protocol (FTP).

- Enable authentication

After users log in to the CLI of the NAS, the users must be authenticated before CLI permission update. This process is called Enable authentication (in Privileged EXEC mode).

- Point-to-Point Protocol (PPP) authentication

PPP authentication is performed for users that initiate dial-up access through PPP.

- Dot1X (IEEE802.1X) authentication

Dot1X (IEEE802.1X) authentication is performed for users that initiate dial-up access through IEEE802.1X.

- iPortal (built-in portal) authentication

iPortal authentication is performed by the first generation portal server.

- Web (second generation portal) authentication

Web authentication is performed by the second generation portal server.

Related Configuration

Enabling AAA

By default, AAA is disabled.

To enable AAA, run the **aaa new-model** command.

Configuring an AAA Authentication Scheme

By default, no AAA authentication scheme is configured.

Before you configure an AAA authentication scheme, determine whether to use local authentication or remote server authentication. If the latter is to be implemented, configure a RADIUS or TACACS+ server in advance. If local authentication is selected, configure the local user database information on the NAS.

▾ **Configuring an AAA Authentication Method List**

By default, no AAA authentication method list is configured.

Determine the access mode to be configured in advance. Then configure authentication methods according to the access mode.

2.3.2 AAA Authorization

AAA authorization allows administrators to control the services or permissions of users. After AAA authorization is enabled, the NAS configures the sessions of users according to the user configuration files stored on the NAS or servers. After authorization, users can use only the services or have only the permissions permitted by the configuration files.

▾ **AAA Authorization Scheme**

- Direct authorization (**none**)

Direct authorization is intended for highly trusted users, who are assigned with the default permissions specified by the NAS.

- Local authorization (**local**)

Local authorization is performed on the NAS, which authorizes users according to the AV pairs configured for local users.

- Remote server-group authorization (**group**)

Authorization is performed jointly by the NAS and a remote server group. You can configure local or direct authorization as standby to avoid authorization failures when all the servers in the server group fail.

▾ **AAA Authorization Types**

- EXEC authorization

After users log in to the CLI of the NAS, the users are assigned with permission levels (0 to 15).

- Config-commands authorization

Users are assigned with the permissions to run specific commands in configuration modes (including the global configuration mode and sub-modes).

- Console authorization

After users log in through consoles, the users are authorized to run commands.

- Command authorization

Authorize users with commands after login to the CLI of the NAS.

- Network authorization

After users access the Internet, the users are authorized to use the specific session services. For example, after users access the Internet through PPP and Serial Line Internet Protocol (SLIP), the users are authorized to use the data service, bandwidth, and timeout service.

Related Configuration

↳ Enabling AAA

By default, AAA is disabled.

To enable AAA, run the **aaa new-model** command.

↳ Configuring an AAA Authorization Scheme

By default, no AAA authorization scheme is configured.

Before you configure an AAA authorization scheme, determine whether to use local authorization or remote server-group authorization. If remote server-group authorization needs to be implemented, configure a RADIUS or TACACS+ server in advance. If local authorization needs to be implemented, configure the local user database information on the NAS.

↳ Configuring an AAA Authorization Method List

By default, no AAA authorization method list is configured.

Determine the access mode to be configured in advance. Then configure authorization methods according to the access mode.

2.3.3 AAA Accounting

In AAA, accounting is an independent process of the same level as authentication and authorization. During the accounting process, start-accounting, update-accounting, and end-accounting requests are sent to the configured accounting server, which records the network resource usage of users and performs accounting, audit, and tracking of users' activities.

In AAA configuration, accounting scheme configuration is optional.

↳ AAA Accounting Schemes

- No accounting (**none**)

Accounting is not performed on users.

- Local accounting (**local**)

Accounting is completed on the NAS, which collects statistics on and limits the number of local user connections. Billing is not performed.

- Remote server-group accounting (**group**)

Accounting is performed jointly by the NAS and a remote server group. You can configure local accounting as standby to avoid accounting failures when all the servers in the server group fail.

↳ AAA Accounting Types

- EXEC accounting

Accounting is performed when users log in to and out of the CLI of the NAS.

- Command accounting

Records are kept on the commands that users run on the CLI of the NAS.

- Network accounting

Records are kept on the sessions that users set up after completing 802.1X and Web authentication to access the Internet.

Related Configuration

↳ Enabling AAA

By default, AAA is disabled.

To enable AAA, run the **aaa new-model** command.

↳ Configuring an AAA Accounting Scheme

By default, no AAA accounting method is configured.

Before you configure an AAA accounting scheme, determine whether to use local accounting or remote server-group accounting. If remote server-group accounting needs to be implemented, configure a RADIUS or TACACS+ server in advance. If local accounting needs to be implemented, configure the local user database information on the NAS.

↳ Configuring an AAA Accounting Method List

By default, no AAA accounting method list is configured.

Determine the access mode to be configured in advance. Then configure accounting methods according to the access mode.

2.3.4 Multi-Domain AAA

In a multi-domain environment, the NAS can provide the AAA services to users in different domains. The user AVs (such as usernames and passwords, service types, and permissions) may vary with different domains. It is necessary to configure domains to differentiate the user AVs in different domains and configure an AV set (including an AAA service method list, for example, RADIUS) for each domain.

Our products support the following username formats:

1. userid@domain-name
2. domain-name\userid
3. userid.domain-name
4. userid

The fourth format (userid) does not contain a domain name, and it is considered to use the **default** domain name.

The NAS provides the domain-based AAA service based on the following principles:

- Resolves the domain name carried by a user.
- Searches for the user domain according to the domain name.

- Searches for the corresponding AAA method list name according to the domain configuration information on the NAS.
- Searches for the corresponding method list according to the method list name.
- Provides the AAA services based on the method list.

i If any of the preceding procedures fails, the AAA services cannot be provided.

Figure 2-4 shows the typical multi-domain topology.

Figure 2-4

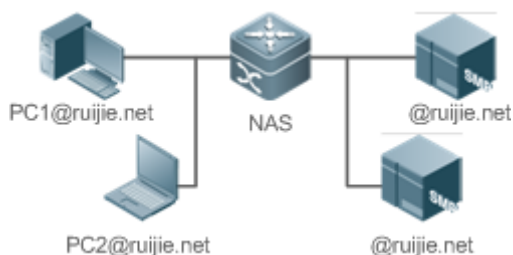

Related Configuration

↳ Enabling AAA

By default, AAA is disabled.

To enable AAA, run the **aaa new-model** command.

↳ Configuring an AAA Method List

By default, no AAA method list is configured.

For details, see section 5.2.1, section 5.2.2, and section 5.2.3.

↳ Enabling the Domain-Based AAA Service

By default, the domain-based AAA service is disabled.

To enable the domain-based AAA service, run the **aaa domain enable** command.

↳ Creating a Domain

By default, no domain is configured.

To configure a domain, run the **aaa domain domain-name** command.

↳ Configuring an AV Set for a Domain

By default, no domain AV set is configured.



A domain AV set contains the following elements: AAA method lists, the maximum number of online users, whether to remove the domain name from the username, and whether the domain name takes effect.



↳ Displaying Domain Configuration

To display domain configuration, run the **show aaa domain** command.

 The system supports a maximum of 32 domains.

2.4 Configuration

| Configuration | Description and Command | |
|--|--|---|
| Configuring AAA Authentication |  Mandatory if user identities need to be verified. | |
| | aaa new-model | Enables AAA. |
| | aaa authentication login | Defines a method list of login authentication. |
| | aaa authentication enable | Defines a method list of Enable authentication. |
| | aaa authentication dot1x | Defines a method list of 802.1X authentication. |
| | aaa authentication ppp | Defines a method list of PPP authentication. |
| | aaa local authentication attempts | Sets the maximum number of login attempts. |
| | aaa local authentication lockout-time | Sets the maximum lockout time after a login failure. |
| | aaa local user allow public account | Enables local account (username or subs) sharing in Web and iPortal authentication. |
| Configuring AAA Authorization |  Mandatory if different permissions and services need to be assigned to users. | |
| | aaa new-model | Enables AAA. |
| | aaa authorization exec | Defines a method list of EXEC authorization. |
| | aaa authorization commands | Defines a method list of command authorization. |
| | aaa authorization network | Configures a method list of network authorization. |
| | authorization exec | Applies EXEC authorization methods to a specified VTY line. |
| | authorization commands | Applies command authorization methods to a specified VTY line. |
| Configuring AAA Accounting |  Mandatory if accounting, statistics, and tracking need to be performed on the network resource usage of users. | |
| | aaa new-model | Enables AAA. |
| | aaa accounting exec | Defines a method list of EXEC accounting. |
| | aaa accounting commands | Defines a method list of command accounting. |
| | aaa accounting network | Defines a method list of network accounting. |

| Configuration | Description and Command | |
|--|--|--|
| | accounting exec | Applies EXEC accounting methods to a specified VTY line. |
| | accounting commands | Applies command accounting methods to a specified VTY line. |
| | aaa accounting update | Enables accounting update. |
| | aaa accounting update periodic | Configures the accounting update interval. |
| Configuring an AAA Server Group |  Recommended if a server group needs to be configured to handle AAA through different servers in the group. | |
| | aaa group server | Creates a user-defined AAA server group. |
| | server | Adds an AAA server group member. |
| | ip vrf forwarding | Configures the VRF attribute of an AAA server group. |
| Configuring the Domain-Based AAA Service |  Mandatory if AAA management of 802.1X access STAs needs to be performed according to domains. | |
| | aaa new-model | Enables AAA. |
| | aaa domain enable | Enables the domain-based AAA service. |
| | aaa domain | Creates a domain and enters domain configuration mode. |
| | authentication dot1x | Associates the domain with an 802.1X authentication method list. |
| | accounting network | Associates the domain with a network accounting method list. |
| | authorization network | Associates the domain with a network authorization method list. |
| | state | Configures the domain status. |
| | username-format | Configures whether to contain the domain name in usernames. |
| access-limit | Configures the maximum number of domain users. | |

2.4.1 Configuring AAA Authentication

Configuration Effect

Verify whether users are able to obtain access permission.

Notes

- If an authentication scheme contains multiple authentication methods, these methods are executed according to the configured sequence.

- The next authentication method is executed only when the current method does not respond. If the current method fails, the next method will be not tried.
- When the **none** method is used, users can get access even when no authentication method gets response. Therefore, the **none** method is used only as standby.

i Normally, do not use None authentication. You can use the **none** method as the last optional authentication method in special cases. For example, all the users who may request access are trusted users and the users' work must not be delayed by system faults. Then you can use the **none** method to assign access permissions to these users when the authentication server does not respond. It is recommended that the local authentication method be added before the **none** method.

- If AAA authentication is enabled but no authentication method is configured and the default authentication method does not exist, users can directly log in to the Console without being authenticated. If users log in by other means, the users must pass local authentication.
- When a user enters the CLI after passing login authentication (the **none** method is not used), the username is recorded. When the user performs Enable authentication, the user is not prompted to enter the username again, because the username that the user entered during login authentication is automatically filled in. However, the user must enter the password previously used for login authentication.
- The username is not recorded if the user does not perform login authentication when entering the CLI or the **none** method is used during login authentication. Then, a user is required to enter the username each time when performing Enable authentication.

Configuration Steps

↳ Enabling AAA

- Mandatory.
- Run the **aaa new-model** command to enable AAA.
- By default, AAA is disabled.

↳ Defining a Method List of Login Authentication

- Run the **aaa authentication login** command to configure a method list of login authentication.
- This configuration is mandatory if you need to configure a login authentication method list (including the configuration of the default method list).
- By default, no method list of login authentication is configured.

↳ Defining a Method List of Enable Authentication

- Run the **aaa authentication enable** command to configure a method list of Enable authentication.
- This configuration is mandatory if you need to configure an Enable authentication method list. (You can configure only the default method list.)
- By default, no method list of Enable authentication is configured.

↘ Defining a Method List of 802.1X Authentication

- Run the **aaa authentication dot1x** command to configure a method list of 802.1X authentication.
- This configuration is mandatory if you need to configure an 802.1X authentication method list (including the configuration of the default method list).
- By default, no method list of 802.1X authentication is configured.

↘ Defining a Method List of PPP Authentication

- Run the **aaa authentication ppp** command to configure a method list of PPP authentication.
- This configuration is mandatory if you need to configure an authentication method list for PPP dial-up access.
- By default, no method list of PPP authentication is configured.

↘ Defining a Method List of Web Authentication

- Run the **aaa authentication web-auth** command to configure a method list of Web authentication.
- This configuration is mandatory if you need to configure a Web authentication method list (including the configuration of the default method list).
- By default, no method list of Web authentication is configured.

↘ Defining a Method List of iPortal Web Authentication

- Run the **aaa authentication iportal** command to configure a method list of iPortal Web authentication.
- This configuration is mandatory if you need to configure an iPortal Web authentication method list (including the configuration of the default method list).
- By default, no method list of iPortal Web authentication is configured.

↘ Defining a Method List of SSL VPN Authentication

- Run the **aaa authentication sslvpn** command to configure a method list of SSL VPN authentication.
- This configuration is mandatory if you need to configure an SSL VPN authentication method list (including the configuration of the default method list).
- By default, no method list of SSL VPN authentication is configured.

↘ Setting the Maximum Number of Login Attempts

- Optional.
- By default, a user is allowed to enter passwords up to three times during login.

↘ Setting the Maximum Lockout Time After a Login Failure

- Optional.
- By default, a user is locked for 15 minutes after entering wrong passwords three times.

↘ Enabling Local Account (username or subs) Sharing in Web and iPortal Authentication

- (Optional) This configuration is supported only on EG products. This function is supported by default on other types of Ruijie products.
- By default, a local account cannot be shared among multiple STAs.

Verification

- Run the **show aaa method-list** command to display the configured method lists.
- Run the **show aaa lockout** command to display the settings of the maximum number of login attempts and the maximum lockout time after a login failure.
- Run the **show running-config** command to display the authentication method lists associated with login authentication and 802.1X authentication.

Related Commands

↘ Enabling AAA

| | |
|---------------------|--|
| Command | aaa new-model |
| Parameter | N/A |
| Description | |
| Command Mode | Global configuration mode |
| Usage Guide | To enable the AAA services, run this command. None of the rest of AAA commands can be effective if AAA is not enabled. |

↘ Defining a Method List of Login Authentication

| | |
|------------------------------|---|
| Command | aaa authentication login { default list-name } method1 [method2...] |
| Parameter Description | <p>default: With this parameter used, the configured method list will be defaulted.</p> <p><i>list-name:</i> Indicates the name of a login authentication method list in characters.</p> <p><i>method:</i> Indicates authentication methods from local, none, group, and subs. A method list contains up to four methods.</p> <p>local: Indicates that the local user database is used for authentication.</p> <p>none: Indicates that authentication is not performed.</p> <p>group: Indicates that a server group is used for authentication. Currently, the RADIUS and TACACS+ server groups are supported.</p> <p>subs: Indicates that the subs database is used for authentication.</p> |
| Command Mode | Global configuration mode |
| Usage Guide | <p>If the AAA login authentication service is enabled on the NAS, users must perform login authentication negotiation through AAA. Run the aaa authentication login command to configure the default or optional method lists for login authentication.</p> <p>In a method list, the next method is executed only when the current method does not receive response.</p> <p>After you configure login authentication methods, apply the methods to the VTY lines that require login</p> |

| | |
|--|--|
| | authentication; otherwise, the methods will not take effect. |
|--|--|

▾ Defining a Method List of Enable Authentication

| | |
|---------------------|--|
| Command | aaa authentication enable default <i>method1</i> [<i>method2...</i>] |
| Parameter | default: With this parameter used, the configured method list will be defaulted. |
| Description | <p><i>list-name:</i> Indicates the name of an Enable authentication method list in characters.</p> <p><i>method:</i> Indicates authentication methods from enable, local, none, and group. A method list contains up to four methods.</p> <p>enable: Indicates that the password that is configured using the enable command is used for authentication.</p> <p>local: Indicates that the local user database is used for authentication.</p> <p>none: Indicates that authentication is not performed.</p> <p>group: Indicates that a server group is used for authentication. Currently, the RADIUS and TACACS+ server groups are supported.</p> |
| Command Mode | Global configuration mode |
| Usage Guide | <p>If the AAA login authentication service is enabled on the NAS, users must perform Enable authentication negotiation through AAA. Run the aaa authentication enable command to configure the default or optional method lists for Enable authentication.</p> <p>In a method list, the next method is executed only when the current method does not receive response.</p> |

▾ Defining a Method List of 802.1X Authentication

| | |
|---------------------|--|
| Command | aaa authentication dot1x { default <i>list-name</i> } <i>method1</i> [<i>method2...</i>] |
| Parameter | default: With this parameter used, the configured method list will be defaulted. |
| Description | <p><i>list-name:</i> Indicates the name of an 802.1X authentication method list in characters.</p> <p><i>method:</i> Indicates authentication methods from local, none, and group. A method list contains up to four methods.</p> <p>local: Indicates that the local user database is used for authentication.</p> <p>none: Indicates that authentication is not performed.</p> <p>group: Indicates that a server group is used for authentication. Currently, the RADIUS server group is supported.</p> |
| Command Mode | Global configuration mode |
| Usage Guide | <p>If the AAA 802.1X authentication service is enabled on the NAS, users must perform 802.1X authentication negotiation through AAA. Run the aaa authentication dot1x command to configure the default or optional method lists for 802.1X authentication.</p> <p>In a method list, the next method is executed only when the current method does not receive response.</p> |

▾ Defining a Method List of PPP, Web, iPortal or SSL VPN Authentication

| | |
|--------------------|--|
| Command | aaa authentication { ppp web-auth iportal sslvpn } { default <i>list-name</i> } <i>method1</i> [<i>method2...</i>] |
| Parameter | ppp: Configures a method list of PPP authentication. |
| Description | web-auth: Configures a method list of Web authentication. |

| | |
|---------------------|---|
| | <p>iportal: Configures a method list of iportal authentication.</p> <p>sslvpn: Configures a method list of SSL VPN authentication.</p> <p>default: With this parameter used, the configured method list will be defaulted.</p> <p><i>list-name:</i> Indicates the name of a PPP authentication method list in characters.</p> <p><i>method:</i> Indicates authentication methods from local, none, group, and subs. A method list contains up to four methods.</p> <p>local: Indicates that the local user database is used for authentication.</p> <p>none: Indicates that authentication is not performed.</p> <p>group: Indicates that a server group is used for authentication. Currently, the RADIUS and TACACS+ server groups are supported.</p> <p>subs: Specifies the SUBS authentication method using the SUBS database.</p> |
| Command Mode | Global configuration mode |
| Usage Guide | <p>If the AAA PPP authentication service is enabled on the NAS, users must perform PPP authentication negotiation through AAA. Run the aaa authentication ppp command to configure the default or optional method lists for PPP authentication.</p> <p>In a method list, the next method is executed only when the current method does not receive response.</p> |

▾ Setting the Maximum Number of Login Attempts

| | |
|------------------------------|--|
| Command | aaa local authentication attempts <i>max-attempts</i> |
| Parameter Description | <i>max-attempts:</i> Indicates the maximum number of login attempts. The value ranges from 1 to 2,147,483,647. |
| Command Mode | Global configuration mode |
| Usage Guide | Use this command to set the maximum number of times a user can attempt to login. |

▾ Setting the Maximum Lockout Time After a Login Failure

| | |
|------------------------------|---|
| Command | aaa local authentication lockout-time <i>lockout-time</i> |
| Parameter Description | <i>lockout-time:</i> Indicates the time during which a user is locked after entering wrong passwords up to the specified times. The value ranges from 1 to 2,147,483,647, in the unit of minutes. |
| Command Mode | Global configuration mode |
| Usage Guide | Use this command to set the maximum time during which a user is locked after entering wrong passwords up to the specified times. |

▾ Setting the Maximum Lockout Time After a Login Failure

| | |
|------------------------------|--|
| Command | aaa local user allow public account |
| Parameter Description | N/A |
| Command Mode | Global configuration mode |

| | |
|--------------------|---|
| Usage Guide | Use this command to configure local account (username or subs) sharing among multiple STAs in Web authentication or iPortal Web authentication. |
|--------------------|---|

Configuration Example

Configuring AAA Login Authentication

Configure a login authentication method list on the NAS containing **group radius** and **local** methods in order.

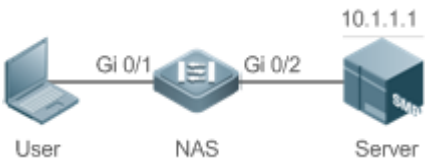
| | |
|-------------------------------|--|
| Scenario Figure 2-5 |  <p>The diagram illustrates a network topology for AAA login authentication. A User laptop is connected to a Network Access Server (NAS) through interface Gi 0/1. The NAS is then connected to a Server through interface Gi 0/2. The Server's IP address is 10.1.1.1.</p> |
| Configuration Steps | <p>Step 1: Enable AAA.</p> <p>Step 2: Configure a RADIUS or TACACS+ server in advance if group-server authentication needs to be implemented. Configure the local user database information on the NAS if local authentication needs to be implemented. (This example requires the configuration of a RADIUS server and local database information.)</p> <p>Step 3: Configure an AAA authentication method list for login authentication users. (This example uses group radius and local in order.)</p> <p>Step 4: Apply the configured method list to an interface or line. Skip this step if the default authentication method is used.</p> |
| NAS | <pre>Ruijie#configure terminal Ruijie(config)#username user password pass Ruijie(config)#aaa new-model Ruijie(config)#radius-server host 10.1.1.1 Ruijie(config)#radius-server key ruijie Ruijie(config)#aaa authentication login list1 group radius local Ruijie(config)#line vty 0 20 Ruijie(config-line)#login authentication list1 Ruijie(config-line)#exit</pre> |
| Verification | Run the show aaa method-list command on the NAS to display the configuration. |
| NAS | <pre>Ruijie#show aaa method-list Authentication method-list: aaa authentication login list1 group radius local</pre> |

| | |
|-------------|---|
| | <pre>Accounting method-list: Authorization method-list:</pre> |
| | <p>Assume that a user remotely logs in to the NAS through Telnet. The user is prompted to enter the username and password on the CLI.</p> <p>The user must enter the correct username and password to access the NAS.</p> |
| User | <pre>User Access Verification Username:user Password:pass</pre> |

📌 **Configuring AAA Enable Authentication**

Configure an Enable authentication method list on the NAS containing **group radius**, **local**, and then **enable** methods in order.

| | |
|--------------------------------------|--|
| Scenario Figure 2-6 | <pre> graph LR User[User] --- Gi01[Gi 0/1] --- NAS[NAS] NAS --- Gi02[Gi 0/2] --- Server[Server] Server --- IP[10.1.1.1] </pre> |
| Configuration Steps | <p>Step 1: Enable AAA.</p> <p>Step 2: Configure a RADIUS or TACACS+ server in advance if group-server authentication needs to be implemented. Configure the local user database information on the NAS if local authentication needs to be implemented. Configure Enable authentication passwords on the NAS if you use Enable password authentication.</p> <p>Step 3: Configure an AAA authentication method list for Enable authentication users.</p> <p>i You can define only one Enable authentication method list globally. You do not need to define the list name but just default it. After that, it will be applied automatically.</p> |
| NAS | <pre>Ruijie#configure terminal Ruijie(config)#username user privilege 15 password pass Ruijie(config)#enable secret w Ruijie(config)#aaa new-model Ruijie(config)#radius-server host 10.1.1.1 Ruijie(config)#radius-server key ruijie Ruijie(config)#aaa authentication enable default group radius local enable</pre> |

| | |
|---------------------|---|
| Verification | Run the show aaa method-list command on the NAS to display the configuration. |
| NAS | <pre>Ruijie#show aaa method-list Authentication method-list: aaa authentication enable default group radius local enable Accounting method-list: Authorization method-list:</pre> |
| | The CLI displays an authentication prompt when the user level is updated to level 15. The user must enter the correct username and password to access the NAS. |
| NAS | <pre>Ruijie>enable Username:user Password:pass Ruijie#</pre> |

↘ Configuring AAA 802.1X Authentication

Configure an 802.1X authentication method list on the NAS containing **group radius**, and then **local** methods in order.

| | |
|--------------------------------------|--|
| Scenario Figure 2-7 |  <pre> graph LR User[User] --- GI01[GI 0/1] --- NAS[NAS] NAS --- GI02[GI 0/2] --- Server[Server] Server --- IP[10.1.1.1] </pre> |
| Configuration Steps | <p>Step 1: Enable AAA.</p> <p>Step 2: Configure a RADIUS server in advance if group-server authentication needs to be implemented. Configure the local user database information on the NAS if local authentication needs to be implemented. (This example requires the configuration of a RADIUS server and local database information.) Currently, 802.1X authentication does not support TACACS+.</p> <p>Step 3: Configure an AAA authentication method list for 802.1X authentication users. (This example uses group radius and local in order.)</p> <p>Step 4: Apply the AAA authentication method list. Skip this step if the default authentication method is used.</p> <p>Step 5: Enable 802.1X authentication on an interface.</p> |
| NAS | <pre>Ruijie#configure terminal Ruijie(config)#username user1 password pass1</pre> |

| | |
|---------------------|---|
| | <pre>Ruijie(config)#username user2 password pass2 Ruijie(config)#aaa new-model Ruijie(config)#radius-server host 10.1.1.1 Ruijie(config)#radius-server key ruijie Ruijie(config)#aaa authentication dotlx default group radius local Ruijie(config)#interface gigabitEthernet 0/1 Ruijie(config-if-gigabitEthernet 0/1)#dot1 port-control auto Ruijie(config-if-gigabitEthernet 0/1)#exit</pre> |
| Verification | Run the show aaa method-list command on the NAS to display the configuration. |
| NAS | <pre>Ruijie#show aaa method-list Authentication method-list: aaa authentication dotlx default group radius local Accounting method-list: Authorization method-list:</pre> |

Common Errors

- No RADIUS server or TACACS+ server is configured.
- Usernames and passwords are not configured in the local database.

2.4.2 Configuring AAA Authorization

Configuration Effect

- Determine what services or permissions authenticated users can enjoy.

Notes

- EXEC authorization is often used with login authentication, which can be implemented on the same line. Authorization and authentication can be performed using different methods and servers. Therefore, the results of the same user may be different. If a user passes login authentication but fails in EXEC authorization, the user cannot enter the CLI.
- The authorization methods in an authorization scheme are executed in accordance with the method configuration sequence. The next authorization method is executed only when the current method does not receive response. If authorization fails using a method, the next method will be not tried.

- Command authorization is supported only by TACACS+.
- Console authorization: The RGOS can differentiate between the users who log in through the Console and the users who log in through other types of clients. You can enable or disable command authorization for the users who log in through the Console. If command authorization is disabled for these users, the command authorization method list applied to the Console line no longer takes effect.

Configuration Steps

↳ Enabling AAA

- Mandatory.
- Run the **aaa new-model** command to enable AAA.
- By default, AAA is disabled.

↳ Defining a Method List of EXEC Authorization

- Run the **aaa authorization exec** command to configure a method list of EXEC authorization.
- This configuration is mandatory if you need to configure an EXEC authorization method list (including the configuration of the default method list).
- By default, no EXEC authorization method list is configured.

i The default access permission level of EXEC users is the lowest. (Console users can connect to the NAS through the Console port or Telnet. Each connection is counted as an EXEC user, for example, a Telnet user and SSH user.)

↳ Defining a Method List of Command Authorization

- Run the **aaa authorization commands** command to configure a method list of command authorization.
- This configuration is mandatory if you need to configure a command authorization method list (including the configuration of the default method list).
- By default, no command authorization method list is configured.

↳ Configuring a Method List of Network Authorization

- Run the **aaa authorization network** command to configure a method list of network authorization.
- This configuration is mandatory if you need to configure a network authorization method list (including the configuration of the default method list).
- By default, no authorization method is configured.

↳ Applying EXEC Authorization Methods to a Specified VTY Line

- Run the **authorization exec** command in line configuration mode to apply EXEC authorization methods to a specified VTY line.
- This configuration is mandatory if you need to apply an EXEC authorization method list to a specified VTY line.
- By default, all VTY lines are associated with the default authorization method list.

↘ Applying Command Authorization Methods to a Specified VTY Line

- Run the **authorization commands** command in line configuration mode to apply command authorization methods to a specified VTY line.
- This configuration is mandatory if you need to apply a command authorization method list to a specified VTY line.
- By default, all VTY lines are associated with the default authorization method list.

↘ Enabling Authorization for Commands in Configuration Modes

- Run the **aaa authorization config-commands** command to enable authorization for commands in configuration modes.
- By default, authorization is disabled for commands in configuration modes.

↘ Enabling Authorization for the Console to Run Commands

- Run the **aaa authorization console** command to enable authorization for console users to run commands.
- By default, authorization is disabled for the Console to run commands.

Verification

Run the **show running-config** command to verify the configuration.

Related Commands

↘ Enabling AAA

| | |
|---------------------|--|
| Command | aaa new-model |
| Parameter | N/A |
| Description | |
| Command Mode | Global configuration mode |
| Usage Guide | To enable the AAA services, run this command. None of the rest of AAA commands can be effective if AAA is not enabled. |

↘ Defining a Method List of EXEC Authorization

| | |
|--------------------|---|
| Command | aaa authorization exec { default list-name } method1 [method2...] |
| Parameter | default: With this parameter used, the configured method list will be defaulted. |
| Description | <p><i>list-name:</i> Indicates the name of an EXEC authorization method list in characters.</p> <p><i>method:</i> Specifies authentication methods from local, none, and group. A method list contains up to four methods.</p> <p>local: Indicates that the local user database is used for EXEC authorization.</p> <p>none: Indicates that EXEC authorization is not performed.</p> <p>group: Indicates that a server group is used for EXEC authorization. Currently, the RADIUS and TACACS+ server groups are supported.</p> |
| Command | Global configuration mode |

| | |
|--------------------|--|
| Mode | |
| Usage Guide | The RGOS supports authorization of the users who log in to the CLI of the NAS to assign the users CLI operation permission levels (0 to 15). Currently, EXEC authorization is performed only on the users who have passed login authentication. If a user fails in EXEC authorization, the user cannot enter the CLI. After you configure EXEC authorization methods, apply the methods to the VTY lines that require EXEC authorization; otherwise, the methods will not take effect. |

▾ Defining a Method List of Command Authorization

| | |
|---------------------|--|
| Command | aaa authorization commands <i>level</i> { default <i>list-name</i> } <i>method1</i> [<i>method2...</i>] |
| Parameter | default: With this parameter used, the configured method list will be defaulted. |
| Description | <i>list-name:</i> Indicates the name of a command authorization method list in characters. <i>method:</i> Indicates authentication methods from none and group . A method list contains up to four methods. none: Indicates that command authorization is not performed. group: Indicates that a server group is used for command authorization. Currently, the TACACS+ server group is supported. |
| Command Mode | Global configuration mode |
| Usage Guide | The RGOS supports authorization of the commands executable by users. When a user enters a command, AAA sends the command to the authentication server. If the authentication server permits the execution, the command is executed. If the authentication server forbids the execution, the command is not executed and a message is displayed showing that the execution is rejected. When you configure command authorization, specify the command level, which is used as the default level. (For example, if a command above Level 14 is visible to users, the default level of the command is 14.) After you configure command authorization methods, apply the methods to the VTY lines that require command authorization; otherwise, the methods will not take effect. |

▾ Configuring a Method List of Network Authorization

| | |
|---------------------|---|
| Command | aaa authorization network { default <i>list-name</i> } <i>method1</i> [<i>method2...</i>] |
| Parameter | default: With this parameter used, the configured method list will be defaulted. |
| Description | <i>list-name:</i> Indicates the name of a network authorization method list in characters. <i>method:</i> Indicates authentication methods from none and group . A method list contains up to four methods. none: Indicates that authentication is not performed. group: Indicates that a server group is used for network authorization. Currently, the RADIUS and TACACS+ server groups are supported. |
| Command Mode | Global configuration mode |
| Usage Guide | The RGOS supports authorization of network-related service requests such as PPP and SLIP requests. After authorization is configured, all authenticated users or interfaces are authorized automatically. You can configure three different authorization methods. The next authorization method is executed only when the current method does not receive response. If authorization fails using a method, the next method |

| | |
|--|--|
| | <p>will be not tried.</p> <p>RADIUS or TACACS+ servers return a series of AV pairs to authorize authenticated users. Network authorization is based on authentication. Only authenticated users can perform network authorization.</p> |
|--|--|

↘ **Enabling Authorization for Commands in Configuration Modes (Including the Global Configuration Mode and Sub-Modes)**

| | |
|------------------------------|--|
| Command | aaa authorization config-commands |
| Parameter Description | N/A |
| Command Mode | Global configuration mode |
| Usage Guide | If you need to enable authorization for commands only in non-configuration modes (for example, privileged EXEC mode), disable authorization in configuration modes by using the no form of this command. Then users can run commands in configuration mode and sub-modes without authorization. |

↘ **Enabling Authorization for the Console to Run Commands**

| | |
|------------------------------|--|
| Command | aaa authorization console |
| Parameter Description | N/A |
| Command Mode | Global configuration mode |
| Usage Guide | The RGOS can differentiate between the users who log in through the Console and the users who log in through other types of clients. You can enable or disable command authorization for the users who log in through the Console. If command authorization is disabled for these users, the command authorization method list applied to the Console line no longer takes effect. |

Configuration Example

↘ **Configuring AAA EXEC Authorization**

Configure login authentication and EXEC authorization for users on VTY lines 0 to 4. Login authentication is performed in local mode, and EXEC authorization is performed on a RADIUS server. If the RADIUS server does not respond, users are redirected to the local authorization.

| | |
|--------------------------------------|---|
| Scenario Figure 2-8 | <p>The diagram illustrates a network topology for AAA EXEC authorization. On the left, a laptop icon represents the 'User'. A line labeled 'Gi 0/1' connects the User to a central server icon labeled 'NAS'. Another line labeled 'Gi 0/2' connects the NAS to a server icon on the right labeled 'Server'. Above the Server icon, the IP address '10.1.1.1' is displayed.</p> |
| Configuration Steps | <p>Step 1: Enable AAA.</p> <p>Step 2: Configure a RADIUS or TACACS+ server in advance if remote server-group authorization needs to be implemented. If local authorization needs to be implemented, configure the local user database information on the NAS.</p> |

| | |
|---------------------|---|
| | <p>Step 3: Configure an AAA authorization method list according to different access modes and service types.</p> <p>Step 4: Apply the configured method list to an interface or line. Skip this step if the default authorization method is used.</p> <p>EXEC authorization is often used with login authentication, which can be implemented on the same line.</p> |
| NAS | <pre>Ruijie#configure terminal Ruijie(config)#username user password pass Ruijie(config)#username user privilege 6 Ruijie(config)#aaa new-model Ruijie(config)#radius-server host 10.1.1.1 Ruijie(config)#radius-server key test Ruijie(config)#aaa authentication login list1 group local Ruijie(config)#aaa authorization exec list2 group radius local Ruijie(config)#line vty 0 4 Ruijie(config-line)#login authentication list1 Ruijie(config-line)# authorization exec list2 Ruijie(config-line)#exit</pre> |
| Verification | Run the show run and show aaa method-list commands on the NAS to display the configuration. |
| NAS | <pre>Ruijie#show aaa method-list Authentication method-list: aaa authentication login list1 group local Accounting method-list: Authorization method-list: aaa authorization exec list2 group radius local</pre> |
| | <pre>Ruijie# show running-config aaa new-model ! aaa authorization exec list2 group local aaa authentication login list1 group radius local</pre> |

```

!
username user password pass
username user privilege 6
!
radius-server host 10.1.1.1
radius-server key 7 093b100133
!
line con 0
line vty 0 4
    authorization exec list2
    login authentication list1
!
End
    
```

📌 **Configuring AAA Command Authorization**

Provide command authorization for login users according to the following default authorization method: Authorize level-15 commands first by using a TACACS+ server. If the TACACS+ server does not respond, local authorization is performed. Authorization is applied to the users who log in through the Console and the users who log in through other types of clients.

| | |
|---------------------------------------|---|
| <p>Scenario Figure 2-9</p> |  |
| <p>Configuration Steps</p> | <p>Step 1: Enable AAA.</p> <p>Step 2: Configure a RADIUS or TACACS+ server in advance if remote server-group authorization needs to be implemented. If local authorization needs to be implemented, configure the local user database information on the NAS.</p> <p>Step 3: Configure an AAA authorization method list according to different access modes and service types.</p> <p>Step 4: Apply the configured method list to an interface or line. Skip this step if the default authorization method is used.</p> |
| <p>NAS</p> | <pre> Ruijie#configure terminal Ruijie(config)#username user1 password pass1 Ruijie(config)#username user1 privilege 15 Ruijie(config)#aaa new-model Ruijie(config)#tacacs-server host 192.168.217.10 </pre> |

| | |
|---------------------|--|
| | <pre>Ruijie(config)#tacacs-server key aaa Ruijie(config)#aaa authentication login default local Ruijie(config)#aaa authorization commands 15 default group tacacs+ local Ruijie(config)#aaa authorization console</pre> |
| Verification | Run the show run and show aaa method-list commands on the NAS to display the configuration. |
| NAS | <pre>Ruijie#show aaa method-list Authentication method-list: aaa authentication login default local Accounting method-list: Authorization method-list: aaa authorization commands 15 default group tacacs+ local</pre> |
| | <pre>Ruijie#show run ! aaa new-model ! aaa authorization console aaa authorization commands 15 default group tacacs+ local aaa authentication login default local ! ! nfpp ! vlan 1 ! username user1 password 0 pass1 username user1 privilege 15 no service password-encryption !</pre> |

```
tacacs-server host 192.168.217.10

tacacs-server key aaa

!

line con 0

line vty 0 4

!

!

end
```

📌 **Configuring AAA Network Authorization**

| | |
|---|---|
| <p>Scenario Figure 2-10</p> |  |
| <p>Configuration Steps</p> | <p>Step 1: Enable AAA.</p> <p>Step 2: Configure a RADIUS or TACACS+ server in advance if remote server-group authorization needs to be implemented. If local authorization needs to be implemented, configure the local user database information on the NAS.</p> <p>Step 3: Configure an AAA authorization method list according to different access modes and service types.</p> <p>Step 4: Apply the configured method list to an interface or line. Skip this step if the default authorization method is used.</p> |
| <p>NAS</p> | <pre>Ruijie#configure terminal Ruijie(config)#aaa new-model Ruijie(config)#radius-server host 10.1.1.1 Ruijie(config)#radius-server key test Ruijie(config)#aaa authorization network default group radius none Ruijie(config)# end</pre> |
| <p>Verification</p> | <p>Run the show aaa method-list command on the NAS to display the configuration.</p> |
| <p>NAS</p> | <pre>Ruijie#show aaa method-list Authentication method-list: Accounting method-list:</pre> |

```
Authorization method-list:  
aaa authorization network default group radius none
```

Common Errors

N/A

2.4.3 Configuring AAA Accounting

Configuration Effect

- Record the network resource usage of users.
- Record the user login and logout processes and the commands executed by users during device management.

Notes

About accounting methods:

- If an accounting scheme contains multiple accounting methods, these methods are executed according to the method configuration sequence. The next accounting method is executed only when the current method does not receive response. If accounting fails using a method, the next method will be not tried.
- After the default accounting method list is configured, it is applied to all VTY lines automatically. If a non-default accounting method list is applied to a line, it will replace the default one. If you apply an undefined method list to a line, the system will display a message indicating that accounting on this line is ineffective. Accounting will take effect only when a defined method list is applied.

EXEC accounting:

- EXEC accounting is performed only when login authentication on the NAS is completed. EXEC accounting is not performed if login authentication is not configured or the **none** method is used for authentication. If Start accounting is not performed for a user upon login, Stop accounting will not be performed when the user logs out.

Command accounting

- Only the TACACS+ protocol supports command accounting.

Configuration Steps

▾ Enabling AAA

- Mandatory.
- Run the **aaa new-model** command to enable AAA.
- By default, AAA is disabled.

▾ Defining a Method List of EXEC Accounting

- Run the **aaa accounting exec** command to configure a method list of EXEC accounting.

- This configuration is mandatory if you need to configure an EXEC accounting method list (including the configuration of the default method list).
- The default access permission level of EXEC users is the lowest. (Console users can connect to the NAS through the Console port or Telnet. Each connection is counted as an EXEC user, for example, a Telnet user and SSH user.)
- By default, no EXEC accounting method list is configured.

▾ Defining a Method List of Command Accounting

- Run the **aaa accounting commands** command to configure a method list of command accounting.
- This configuration is mandatory if you need to configure a command accounting method list (including the configuration of the default method list).
- By default, no command accounting method list is configured. Only the TACACS+ protocol supports command accounting.

▾ Defining a Method List of Network Accounting

- Run the **aaa accounting network** command to configure a method list of network accounting.
- This configuration is mandatory if you need to configure a network accounting method list (including the configuration of the default method list).
- By default, no network accounting method list is configured.

▾ Applying EXEC Accounting Methods to a Specified VTY Line

- Run the **accounting exec** command in line configuration mode to apply EXEC accounting methods to a specified VTY line.
- This configuration is mandatory if you need to apply an EXEC accounting method list to a specified VTY line.
- You do not need to run this command if you apply the default method list.
- By default, all VTY lines are associated with the default accounting method list.

▾ Applying Command Accounting Methods to a Specified VTY Line

- Run the **accounting commands** command in line configuration mode to apply command accounting methods to a specified VTY line.
- This configuration is mandatory if you need to apply a command accounting method list to a specified VTY line.
- You do not need to run this command if you apply the default method list.
- By default, all VTY lines are associated with the default accounting method list.

▾ Applying 802.1X Network Accounting Methods

- Run the **dot1x accounting network** command to configure 802.1X network accounting methods.
- This configuration is mandatory if you need to specify 802.1X network accounting methods.
- You do not need to run this command if you apply the default method list.

- By default, all VTY lines are associated with the default accounting method list.

↘ Enabling Accounting Update

- Optional.
- It is recommended that accounting update be configured for improved accounting accuracy.
- By default, accounting update is disabled.

↘ Configuring the Accounting Update Interval

- Optional.
- It is recommended that the accounting update interval not be configured unless otherwise specified.

Verification

Run the **show running-config** command to verify the configuration.

Related Commands

↘ Enabling AAA

| | |
|------------------------------|--|
| Command | aaa new-model |
| Parameter Description | N/A |
| Command Mode | Global configuration mode |
| Usage Guide | To enable the AAA services, run this command. None of the rest of AAA commands can be effective if AAA is not enabled. |

↘ Defining a Method List of EXEC Accounting

| | |
|------------------------------|--|
| Command | aaa accounting exec { default list-name } start-stop method1 [method2...] |
| Parameter Description | <p>default: With this parameter used, the configured method list will be defaulted.</p> <p><i>list-name:</i> Indicates the name of an EXEC accounting method list in characters.</p> <p><i>method:</i> Indicates authentication methods from none and group. A method list contains up to four methods.</p> <p>none: Indicates that EXEC accounting is not performed.</p> <p>group: Indicates that a server group is used for EXEC accounting. Currently, the RADIUS and TACACS+ server groups are supported.</p> |
| Command Mode | Global configuration mode |
| Usage Guide | <p>The RGOS enables EXEC accounting only when login authentication is completed. EXEC accounting is not performed if login authentication is not performed or the none authentication method is used.</p> <p>After accounting is enabled, when a user logs in to the CLI of the NAS, the NAS sends a start-accounting message to the authentication server. When the user logs out, the NAS sends a stop-accounting message to the authentication server. If the NAS does not send a start-accounting message when the user logs in, the</p> |

| | |
|--|--|
| | <p>NAS will not send a stop-accounting message when the user logs out.</p> <p>After you configure EXEC accounting methods, apply the methods to the VTY lines that require EXEC accounting; otherwise, the methods will not take effect.</p> |
|--|--|

↘ Defining a Method List of Command Accounting

| | |
|------------------------------|--|
| Command | aaa accounting commands <i>level</i> { default <i>list-name</i> } start-stop <i>method1</i> [<i>method2...</i>] |
| Parameter Description | <p><i>level</i>: Indicates the command level for which accounting will be performed. The value ranges from 0 to 15.</p> <p>After a command of the configured level is executed, the accounting server records related information based on the received accounting packet.</p> <p>default: With this parameter used, the configured method list will be defaulted.</p> <p><i>list-name</i>: Indicates the name of a command accounting method list in characters.</p> <p><i>method</i>: Indicates authentication methods from none and group. A method list contains up to four methods.</p> <p>none: Indicates that command accounting is not performed.</p> <p>group: Indicates that a server group is used for command accounting. Currently, the TACACS+ server group is supported.</p> |
| Command Mode | Global configuration mode |
| Usage Guide | <p>The RGOS enables command accounting only when login authentication is completed. Command accounting is not performed if login authentication is not performed or the none authentication method is used. After accounting is enabled, the NAS records information about the commands of the configured level that users run and sends the information to the authentication server.</p> <p>After you configure command accounting methods, apply the methods to the VTY lines that require command accounting; otherwise, the methods will not take effect.</p> |

↘ Defining a Method List of Network Accounting

| | |
|------------------------------|--|
| Command | aaa accounting network { default <i>list-name</i> } start-stop <i>method1</i> [<i>method2...</i>] |
| Parameter Description | <p>default: With this parameter used, the configured method list will be defaulted.</p> <p><i>list-name</i>: Indicates the name of a network accounting method list in characters.</p> <p>start-stop: Indicates that a start-accounting message and a stop-accounting message are sent when a user accesses a network and when the user disconnects from the network respectively. The start-accounting message indicates that the user is allowed to access the network, regardless of whether accounting is successfully enabled.</p> <p><i>method</i>: Indicates authentication methods from none and group. A method list contains up to four methods.</p> <p>none: Indicates that network accounting is not performed.</p> <p>group: Indicates that a server group is used for network accounting. Currently, the RADIUS and TACACS+ server groups are supported.</p> |
| Command Mode | Global configuration mode |
| Usage Guide | <p>The RGOS sends record attributes to the authentication server to perform accounting of user activities. The start-stop keyword is used to configure user accounting options.</p> |

↘ Enabling Accounting Update

| | |
|---------------------|---|
| Command | aaa accounting update |
| Parameter | N/A |
| Description | |
| Command Mode | Global configuration mode |
| Usage Guide | Accounting update cannot be used if the AAA services are not enabled. After the AAA services are enabled, run this command to enable accounting update. |

↘ Configuring the Accounting Update Interval

| | |
|------------------------------|---|
| Command | aaa accounting update periodic <i>interval</i> |
| Parameter Description | <i>Interval</i> : Indicates the accounting update interval, in the unit of minutes. The shortest is 1 minute. |
| Command Mode | Global configuration mode |
| Usage Guide | Accounting update cannot be used if the AAA services are not enabled. After the AAA services are enabled, run this command to configure the accounting update interval. |

Configuration Example

↘ Configuring AAA EXEC Accounting

Configure login authentication and EXEC accounting for users on VTY lines 0 to 4. Login authentication is performed in local mode, and EXEC accounting is performed on a RADIUS server.

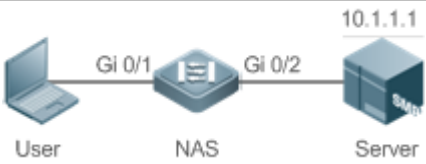
| | |
|--------------------------------|--|
| Scenario Figure 2-11 |  <p>The diagram illustrates a network topology for AAA EXEC accounting. A User (represented by a laptop) is connected to a Network Access Server (NAS, represented by a switch) through interface Gi 0/1. The NAS is further connected to a Server (represented by a server rack) through interface Gi 0/2. The Server's IP address is indicated as 10.1.1.1.</p> |
| Configuration Steps | <p>Step 1: Enable AAA.</p> <p>If remote server-group accounting needs to be implemented, configure a RADIUS or TACACS+ server in advance.</p> <p>Step 2: Configure an AAA accounting method list according to different access modes and service types.</p> <p>Step 3: Apply the configured method list to an interface or line. Skip this step if the default accounting method is used.</p> |
| NAS | <pre>Ruijie#configure terminal Ruijie(config)#username user password pass Ruijie(config)#aaa new-model Ruijie(config)#radius-server host 10.1.1.1 Ruijie(config)#radius-server key test</pre> |

| | |
|---------------------|---|
| | <pre>Ruijie(config)#aaa authentication login list1 group local Ruijie(config)#aaa accounting exec list3 start-stop group radius Ruijie(config)#line vty 0 4 Ruijie(config-line)#login authentication list1 Ruijie(config-line)# accounting exec list3 Ruijie(config-line)#exit</pre> |
| Verification | Run the show run and show aaa method-list commands on the NAS to display the configuration. |
| NAS | <pre>Ruijie#show aaa method-list Authentication method-list: aaa authentication login list1 group local Accounting method-list: aaa accounting exec list3 start-stop group radius Authorization method-list:</pre> |
| | <pre>Ruijie# show running-config aaa new-model ! aaa accounting exec list3 start-stop group radius aaa authentication login list1 group local ! username user password pass ! radius-server host 10.1.1.1 radius-server key 7 093b100133 ! line con 0 line vty 0 4 accounting exec list3 login authentication list1</pre> |

```
!
End
```

📌 **Configuring AAA Command Accounting**



Configure command accounting for login users according to the default accounting method. Login authentication is performed in local mode, and command accounting is performed on a TACACS+ server.

| | |
|---|---|
| <p>Scenario Figure 2-12</p> |  |
| <p>Configuration Steps</p> | <p>Step 1: Enable AAA.</p> <p>If remote server-group accounting needs to be implemented, configure a RADIUS or TACACS+ server in advance.</p> <p>Step 2: Configure an AAA accounting method list according to different access modes and service types.</p> <p>Step 3: Apply the configured method list to an interface or line. Skip this step if the default accounting method is used.</p> |
| <p>NAS</p> | <pre>Ruijie#configure terminal Ruijie(config)#username user1 password pass1 Ruijie(config)#username user1 privilege 15 Ruijie(config)#aaa new-model Ruijie(config)#tacacs-server host 192.168.217.10 Ruijie(config)#tacacs-server key aaa Ruijie(config)#aaa authentication login default local Ruijie(config)#aaa accounting commands 15 default start-stop group tacacs+</pre> |
| <p>Verification</p> | <p>Run the show aaa method-list command on the NAS to display the configuration.</p> |
| <p>NAS</p> | <pre>Ruijie#show aaa method-list Authentication method-list: aaa authentication login default local Accounting method-list: aaa accounting commands 15 default start-stop group tacacs+</pre> |

| | |
|--|--|
| | Authorization method-list: |
| | <pre>Ruijie#show run ! aaa new-model ! aaa authorization config-commands aaa accounting commands 15 default start-stop group tacacs+ aaa authentication login default local ! ! nfpp ! vlan 1 ! username user1 password 0 pass1 username user1 privilege 15 no service password-encryption ! tacacs-server host 192.168.217.10 tacacs-server key aaa ! line con 0 line vty 0 4 ! ! end</pre> |

📌 Configuring AAA Network Accounting

Configure a network accounting method list for 802.1X STAs, and configure a RADIUS remote server for authentication and accounting.

| | |
|---------------------------------------|---|
| Scenario Figure 2-13 |  |
| Configuration Steps | <p>Step 1: Enable AAA.</p> <p>Step 2: If remote server-group accounting needs to be implemented, configure a RADIUS server in advance.</p> <p>Step 3: Configure an AAA accounting method list according to different access modes and service types.</p> <p>Step 4: Apply the configured AAA accounting method list. Skip this step if the default accounting method is used.</p> <hr/> <p> Accounting is performed only when 802.1X authentication is completed.</p> |
| NAS | <pre>Ruijie#configure terminal Ruijie(config)#username user password pass Ruijie(config)#aaa new-model Ruijie(config)#radius-server host 10.1.1.1 Ruijie(config)#radius-server key test Ruijie(config)#aaa authentication dot1x autlx group radius local Ruijie(config)#aaa accounting network acclx start-stop group radius Ruijie(config)#dot1x authentication autlx Ruijie(config)#dot1x accounting acclx Ruijie(config)#interface gigabitEthernet 0/1 Ruijie(config-if-GigabitEthernet 0/1)#dot1 port-control auto Ruijie(config-if-GigabitEthernet 0/1)#exit</pre> |
| Verification | <p>Run the show aaa method-list command on the NAS to display the configuration.</p> |
| NAS | <pre>Ruijie#show aaa method-list Authentication method-list: aaa authentication dot1x autlx group radius local Accounting method-list: aaa accounting network acclx start-stop group radius Authorization method-list:</pre> |

Common Errors

N/A

2.4.4 Configuring an AAA Server Group

Configuration Effect

- Create a user-defined server group and add one or more servers to the group.
- When you configure authentication, authorization, and accounting method lists, name the methods after the server group name so that the servers in the group are used to handle authentication, authorization, and accounting requests.
- Use self-defined server groups to separate authentication, authorization, and accounting.

Notes

In a user-defined server group, you can specify and apply only the servers in the default server group.

Configuration Steps

↳ Creating a User-Defined AAA Server Group

- Mandatory.
- Assign a meaningful name to the user-defined server group. Do not use the predefined **radius** and **tacacs+** keywords in naming.

↳ Adding an AAA Server Group Member

- Mandatory.
- Run the **server** command to add AAA server group members.
- By default, a user-defined server group does not have servers.

↳ Configuring the VRF Attribute of an AAA Server Group

- Optional.
- Run the **ip vrf forwarding** command to configure the VRF attribute of an AAA server group.
- By default, the AAA server group belongs to the global VRF table.

Verification

Run the **show aaa group** command to verify the configuration.

Related Commands

↳ Creating a User-Defined AAA Server Group

| | |
|--------------------|---|
| Command | aaa group server {radius tacacs+} name |
| Parameter | <i>name</i> : Indicates the name of the server group to be created. The name must not contain the radius and |
| Description | tacacs+ keywords because they are the names of the default RADIUS and TACACS+ server groups. |

| | |
|---------------------|---|
| Command Mode | Global configuration mode |
| Usage Guide | Use this command to configure an AAA server group. Currently, the RADIUS and TACACS+ server groups are supported. |

➤ Adding an AAA Server Group Member

| | |
|------------------------------|--|
| Command | server <i>ip-addr</i> [auth-port <i>port1</i>] [acct-port <i>port2</i>] |
| Parameter Description | <i>ip-addr</i> : Indicates the IP address of a server. <i>port1</i> : Indicates the authentication port of a server. (This parameter is supported only by the RADIUS server group.) <i>port2</i> : Indicates the accounting port of a server. (This parameter is supported only by the RADIUS server group.) |
| Command Mode | Server group configuration mode |
| Usage Guide | When you add servers to a server group, the default ports are used if you do not specify ports. |

➤ Configuring the VRF Attribute of an AAA Server Group

| | |
|------------------------------|---|
| Command | ip vrf forwarding <i>vrf_name</i> |
| Parameter Description | <i>vrf_name</i> : Indicates the name of a VRF table. |
| Command Mode | Server group configuration mode |
| Usage Guide | Use this command to assign a VRF table to the specified server group. |

Configuration Example

➤ Creating an AAA Server Group

Create RADIUS server groups named g1 and g2. The IP addresses of the servers in g1 are 10.1.1.1 and 10.1.1.2, and the IP addresses of the servers in g2 are 10.1.1.3 and 10.1.1.4.

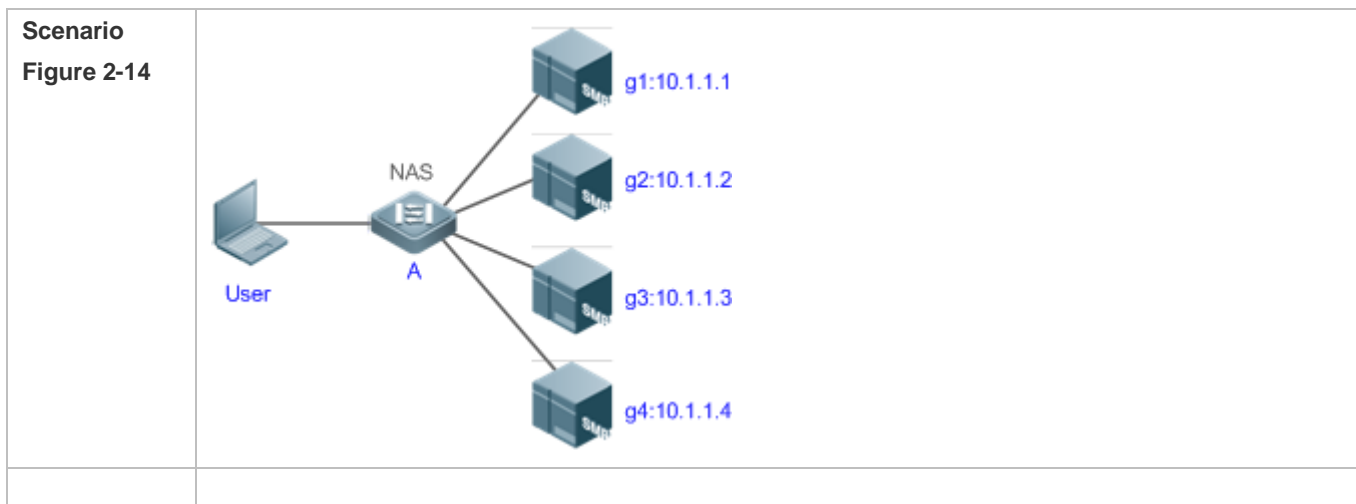

| | |
|----------------------------|--|
| Prerequisites | <ol style="list-style-type: none"> The required interfaces, IP addresses, and VLANs have been configured on the network, network connections have been set up, and the routes from the NAS to servers are reachable. Enable AAA. |
| Configuration Steps | <p>Step 1: Configure a server (which belongs to the default server group).</p> <p>Step 2: Create user-defined AAA server groups.</p> <p>Step 3: Add servers to the AAA server groups.</p> |
| NAS | <pre>Ruijie#configure terminal Ruijie(config)#radius-server host 10.1.1.1 Ruijie(config)#radius-server host 10.1.1.2 Ruijie(config)#radius-server host 10.1.1.3 Ruijie(config)#radius-server host 10.1.1.4 Ruijie(config)#radius-server key secret Ruijie(config)#aaa group server radius g1 Ruijie(config-gs-radius)#server 10.1.1.1 Ruijie(config-gs-radius)#server 10.1.1.2 Ruijie(config-gs-radius)#exit Ruijie(config)#aaa group server radius g2 Ruijie(config-gs-radius)#server 10.1.1.3 Ruijie(config-gs-radius)#server 10.1.1.4 Ruijie(config-gs-radius)#exit</pre> |
| Verification | Run the show aaa group and show run commands on the NAS to display the configuration. |
| NAS | <pre>Ruijie#show aaa group Type Reference Name ----- radius 1 radius tacacs+ 1 tacacs+ radius 1 g1 radius 1 g2</pre> |
| | <pre>Ruijie#show run !</pre> |

```
radius-server host 10.1.1.1
radius-server host 10.1.1.2
radius-server host 10.1.1.3
radius-server host 10.1.1.4
radius-server key secret
!
aaa group server radius g1
  server 10.1.1.1
  server 10.1.1.2
!
aaa group server radius g2
  server 10.1.1.3
  server 10.1.1.4
!
!
```

Common Errors

- For RADIUS servers that use non-default authentication and accounting ports, when you run the **server** command to add servers, specify the authentication or accounting port.
- Only the RADIUS server group can be configured with the VRF attribute.

2.4.5 Configuring the Domain-Based AAA Service

Configuration Effect

Create AAA schemes for 802.1X users in different domains.

Notes

About referencing method lists in domains:

- The AAA method lists that you select in domain configuration mode should be defined in advance. If the method lists are not defined in advance, when you select them in domain configuration mode, the system prompts that the configurations do not exist.
- The names of the AAA method lists selected in domain configuration mode must be consistent with those of the method lists defined for the AAA service. If they are inconsistent, the AAA service cannot be properly provided to the users in the domain.

About the default domain:

- Default domain: After the domain-based AAA service is enabled, if a username does not carry domain information, the AAA service is provided to the user based on the default domain. If the domain information carried by the username is not configured in the system, the system determines that the user is unauthorized and will not provide the AAA service to the user. If the default domain is not configured initially, it must be created manually.
- When the domain-based AAA service is enabled, the default domain is not configured by default and needs to be created manually. The default domain name is **default**. It is used to provide the AAA service to the users whose usernames do not carry domain information. If the default domain is not configured, the AAA service is not available for the users whose usernames do not carry domain information.

About domain names:

- The domain names carried by usernames and those configured on the NAS are matched in the longest matching principle. For example, if two domains, **domain.com** and **domain.com.cn** are configured on a NAS and a user sends a request carrying **aaa@domain.com**, the NAS determines that the user belongs to **domain.com**, instead of **domain.com.cn**.
- If the username of an authenticated user carries domain information but the domain is not configured on the NAS, the AAA service is not provided to the user.

Configuration Steps

▾ Enabling AAA

- Mandatory.
- Run the **aaa new-model** command to enable AAA.
- By default, AAA is disabled.

▾ Enabling the Domain-Based AAA Service

- Mandatory.
- Run the **aaa domain enable** command to enable the domain-based AAA service.
- By default, the domain-based AAA service is disabled.

▾ Creating a Domain and Entering Domain Configuration Mode

- Mandatory.
- Run the **aaa domain** command to create a domain or enter the configured domain.
- By default, no domain is configured.

▾ Associating the Domain with an 802.1X Authentication Method List

- Run the **authentication dot1x** command to associate the domain with an 802.1X authentication method list.
- This configuration is mandatory if you need to apply a specified 802.1X authentication method list to the domain.
- Currently, the domain-based AAA service is applicable only to 802.1X access.

▾ Associating the Domain with a Network Accounting Method List

- Run the **accounting network** command to associate the domain with a network accounting method.
- This configuration is mandatory if you need to apply a specified network accounting method list to the domain.
- If a domain is not associated with a network accounting method list, by default, the global default method list is used for accounting.

↘ **Associating the Domain with a Network Authorization Method List**

- Run the **authorization network** command to associate the domain with a network authorization method list.
- This configuration is mandatory if you need to apply a specified network authorization method list to the domain.
- If a domain is not associated with a network authorization method list, by default, the global default method list is used for authorization.

↘ **Configuring the Domain Status**

- Optional.
- When a domain is in Block state, the users in the domain cannot log in.
- By default, after a domain is created, its state is Active, indicating that all the users in the domain are allowed to request network services.

↘ **Configuring Whether to Contain the Domain Name in Usernames**

- Optional.
- By default, the usernames exchanged between the NAS and an authentication server carry domain information.

↘ **Configuring the Maximum Number of Domain Users**

- Optional.
- By default, the maximum number of access users allowed in a domain is not limited.

Verification

Run the **show aaa domain** command to verify the configuration.

Related Commands

↘ **Enabling AAA**

| | |
|---------------------|--|
| Command | aaa new-model |
| Parameter | N/A |
| Description | |
| Command Mode | Global configuration mode |
| Usage Guide | To enable the AAA services, run this command. None of the rest of AAA commands can be effective if AAA is not enabled. |

↘ **Enabling the Domain-Based AAA Service**

| | |
|---------------------|--|
| Command | aaa domain enable |
| Parameter | N/A |
| Description | |
| Command Mode | Global configuration mode |
| Usage Guide | Use this command to enable the domain-based AAA service. |

↘ Creating a Domain and Entering Domain Configuration Mode

| | |
|---------------------|---|
| Command | aaa domain { default domain-name } |
| Parameter | default: Uses this parameter to configure the default domain. |
| Description | <i>domain-name:</i> Indicates the name of the domain to be created. |
| Command Mode | Global configuration mode |
| Usage Guide | Use this command to configure a domain to provide the domain-based AAA service. The default parameter specifies the default domain. If a username does not carry domain information, the NAS uses the method list associated with the default domain to provide the AAA service to the user. The <i>domain-name</i> parameter specifies the name of the domain to be created. If the domain name carried by a username matches the configured domain name, the NAS uses the method list associated with this domain to provide the AAA service to the user. The system supports a maximum of 32 domains. |

↘ Associating the Domain with an 802.1X Authentication Method List

| | |
|---------------------|--|
| Command | authentication dot1x { default list-name } |
| Parameter | default: Indicates that the default method list is used. |
| Description | <i>list-name:</i> Indicates the name of the method list to be associated. |
| Command Mode | Domain configuration mode |
| Usage Guide | Use this command to associate the domain with a 802.1X authentication method list. |

↘ Associating the Domain with a Network Accounting Method List

| | |
|---------------------|---|
| Command | accounting network { default list-name } |
| Parameter | default: Indicates that the default method list is used. |
| Description | <i>list-name:</i> Indicates the name of the method list to be associated. |
| Command Mode | Domain configuration mode |
| Usage Guide | Use this command to associate the domain with a network accounting method list. |

↘ Associating the Domain with a Network Authorization Method List

| | |
|--------------------|---|
| Command | authorization network { default list-name } |
| Parameter | default: Indicates that the default method list is used. |
| Description | <i>list-name:</i> Indicates the name of the method list to be associated. |

| | |
|---------------------|---------------------------|
| Command Mode | Domain configuration mode |
| Usage Guide | |

↘ Configuring the Domain Status

| | |
|------------------------------|---|
| Command | state { block active } |
| Parameter Description | block: Indicates that the configured domain is invalid. active: Indicates that the configured domain is valid. |
| Command Mode | Domain configuration mode |
| Usage Guide | Use this command to make the configured domain valid or invalid. |

↘ Configuring Whether to Contain the Domain Name in Usernames

| | |
|------------------------------|---|
| Command | username-format { without-domain with-domain } |
| Parameter Description | without-domain: Indicates to remove domain information from usernames. with-domain: Indicates to keep domain information in usernames. |
| Command Mode | Domain configuration mode |
| Usage Guide | Use this command in domain configuration mode to determine whether to include domain information in usernames when the NAS interacts with authentication servers in a specified domain. |

↘ Configuring the Maximum Number of Domain Users

| | |
|------------------------------|--|
| Command | access-limit num |
| Parameter Description | <i>num</i> : Indicates the maximum number of access users allowed in a domain. This limit is applicable only to 802.1X STAs. |
| Command Mode | Domain configuration mode |
| Usage Guide | Use this command to limit the number of access users in a domain. |

Configuration Example

↘ Configuring the Domain-Based AAA Services

Configure authentication and accounting through a RADIUS server to 802.1X users (username: *user@domain.com*) that access the NAS. The usernames that the NAS sends to the RADIUS server do not carry domain information, and the number of access users is not limited.

| | |
|--------------------------------|--|
| Scenario Figure 2-15 |  <pre> graph LR User[User] --- GI01[GI 0/1] --- NAS[NAS] NAS --- GI02[GI 0/2] --- Server[Server] Server --- IP[10.1.1.1] </pre> |
| Configuration | The following example shows how to configure RADIUS authentication and accounting, which requires the |

| | |
|---------------------|---|
| Steps | <p>configuration of a RADIUS server in advance.</p> <p>Step 1: Enable AAA.</p> <p>Step 2: Define an AAA method list.</p> <p>Step 3: Enable the domain-based AAA service.</p> <p>Step 4: Create a domain.</p> <p>Step 5: Associate the domain with the AAA method list.</p> <p>Step 6: Configure the domain attribute.</p> |
| NAS | <pre>Ruijie#configure terminal Ruijie(config)#aaa new-model Ruijie(config)#radius-server host 10.1.1.1 Ruijie(config)#radius-server key test Ruijie(config)#aaa authentication dot1x default group radius Ruijie(config)#aaa accounting network list3 start-stop group radius Ruijie(config)# aaa domain enable Ruijie(config)# aaa domain domain.com Ruijie(config-aaa-domain)# authentication dot1x default Ruijie(config-aaa-domain)# accounting network list3 Ruijie(config-aaa-domain)# username-format without-domain</pre> |
| | |
| Verification | Run the show run and show aaa domain command on the NAS to display the configuration. |
| NAS | <pre>Ruijie#show aaa domain domain.com =====Domain domain.com===== State: Active Username format: With-domain Access limit: No limit 802.1X Access statistic: 0 Selected method list: authentication dot1x default accounting network list3</pre> |
| | <pre>Ruijie#show run</pre> |

```
Building configuration...

Current configuration : 1449 bytes
version RGOS 10.4(3) Release(101069) (Wed Oct 20 09:12:40 CST 2010 -ngcf67)

co-operate enable
!
aaa new-model
aaa domain enable
!
aaa domain domain.com
    authentication dot1x default
    accounting network list3
!
aaa accounting network list3 start-stop group radius
aaa authentication dot1x default group radius
!
nfpp
!
no service password-encryption
!
radius-server host 10.1.1.1
radius-server key test
!
line con 0
line vty 0 4
!
end
```

Common Errors

N/A

2.5 Monitoring

Clearing

| Description | Command |
|--------------------------|--|
| Clears the locked users. | clear aaa local user lockout {all user-name <i>username</i> } |

Displaying

| Description | Command |
|---|-----------------------------------|
| Displays the accounting update information. | show aaa accounting update |
| Displays the current domain configuration. | show aaa domain |
| Displays the current lockout configuration. | show aaa lockout |
| Displays the AAA server groups. | show aaa group |
| Displays the AAA method lists. | show aaa method-list |
| Displays the AAA users. | show aaa user |

3 Configuring RADIUS

3.1 Overview

The Remote Authentication Dial-In User Service (RADIUS) is a distributed client/server system.

RADIUS works with the Authentication, Authorization, and Accounting (AAA) to conduct identity authentication on users who attempt to access a network, to prevent unauthorized access. In RGOS implementation, a RADIUS client runs on a device or Network Access Server (NAS) and transmits identity authentication requests to the central RADIUS server, where all user identity authentication information and network service information are stored. In addition to the authentication service, the RADIUS server provides authorization and accounting services for access users.

RADIUS is often applied in network environments that have high security requirements and allow the access of remote users. RADIUS is a completely open protocol and the RADIUS server is installed on many operating systems as a component, for example, on UNIX, Windows 2000, and Windows 2008. Therefore, RADIUS is the most widely applied security server currently.

The Dynamic Authorization Extensions to Remote Authentication Dial In User Service is defined in the IETF RFC3576. This protocol defines a user offline management method. Devices communicate with the RADIUS server through the Disconnect-Messages (DMs) to bring authenticated users offline. This protocol implements compatibility between devices of different vendors and the RADIUS server in terms of user offline processing.

In the DM mechanism, the RADIUS server actively initiates a user offline request to a device, the device locates a user according to the user session information, user name, and other information carried in the request and brings the user offline. Then, the device returns a response packet that carries the processing result to the RADIUS server, thereby implementing user offline management of the RADIUS server.

Protocols and Standards

- RFC2865: Remote Authentication Dial In User Service (RADIUS)
- RFC2866: RADIUS Accounting
- RFC2867: RADIUS Accounting Modifications for Tunnel Protocol Support
- RFC2868: RADIUS Attributes for Tunnel Protocol Support
- RFC2869: RADIUS Extensions
- RFC3576: Dynamic Authorization Extensions to Remote Authentication Dial In User Service (RADIUS)

3.2 Applications

| Application | Description |
|---|---|
| Providing Authentication, Authorization, and Accounting | Authentication, authorization, and accounting are conducted on access users on a network, to prevent unauthorized access or operations. |

| Application | Description |
|---|--|
| Services for Access Users | |
| Forcing Users to Go Offline | The server forces an authenticated user to go offline. |

3.2.1 Providing Authentication, Authorization, and Accounting Services for Access Users

Scenario

RADIUS is typically applied in the authentication, authorization, and accounting of access users. A network device serves as a RADIUS client and transmits user information to a RADIUS server. After completing processing, the RADIUS server returns the authentication acceptance/authentication rejection/accounting response information to the RADIUS client. The RADIUS client performs processing on the access user according to the response from the RADIUS server.

Figure 3-1 Typical RADIUS Networking Topology

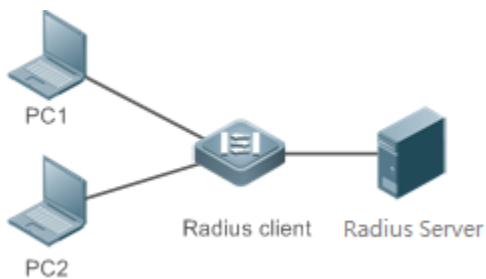

| | |
|----------------|--|
| Remarks | <p>PC 1 and PC 2 are connected to the RADIUS client as access users in wired or wireless mode, and initiate authentication and accounting requests.</p> <p>The RADIUS client is usually an access switch or aggregate switch.</p> <p>The RADIUS server can be a component built in the Windows 2000/2003, Server (IAS), or UNIX operating system or dedicated server software provided by vendors.</p> |
|----------------|--|

Deployment

- Configure access device information on the RADIUS server, including the IP address and shared key of the access devices.
- Configure the AAA method list on the RADIUS client.
- Configure the RADIUS server information on the RADIUS client, including the IP address and shared key.
- Enable access control on the access port of the RADIUS client.
- Configure the network so that the RADIUS client communicates with the RADIUS server successfully.

3.2.2 Forcing Users to Go Offline

Scenario

The RADIUS server forces authenticated online users to go offline for the sake of management.

See Figure 3-1 for the networking topology.

Deployment

- Add the following deployment on the basis of 1.2.1 "Deployment".
- Enable the RADIUS dynamic authorization extension function on the RADIUS client.

3.3 Features

Basic Concepts

Client/Server Mode

- Client: A RADIUS client initiates RADIUS requests and usually runs on a device or NAS. It transmits user information to the RADIUS server, receives responses from the RADIUS server, and performs processing accordingly. The processing includes accepting user access, rejecting user access, or collecting more user information for the RADIUS server.
- Server: Multiple RADIUS clients map to one RADIUS server. The RADIUS server maintains the IP addresses and shared keys of all RADIUS clients as well as information on all authenticated users. It receives requests from a RADIUS client, conducts authentication, authorization, and accounting, and returns processing information to the RADIUS client.

Structure of RADIUS Packets

The following figure shows the structure of RADIUS packets.

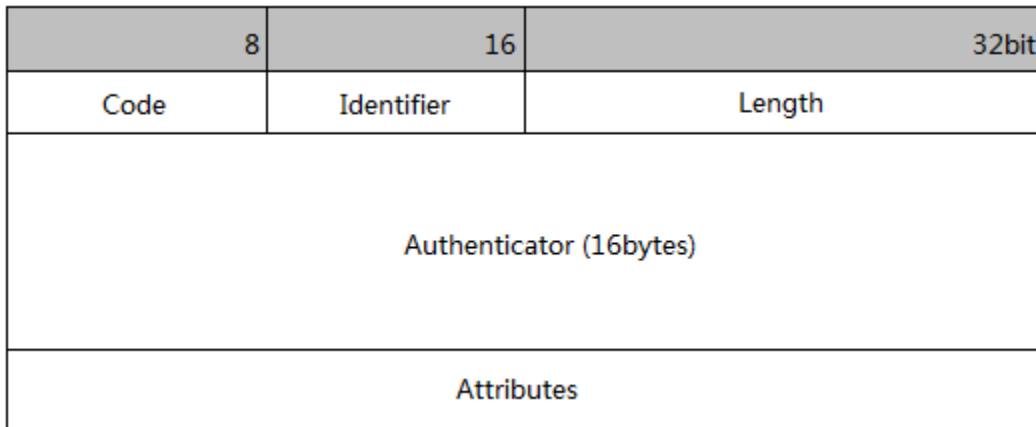

- Code: Identifies the type of RADIUS packets, which occupies one byte. The following table lists the values and meanings.

| Code | Packet Type | Code | Packet Type |
|------|----------------|------|---------------------|
| 1 | Access-Request | 4 | Accounting-Request |
| 2 | Access-Accept | 5 | Accounting-Response |
| 3 | Access-Reject | 11 | Access-Challenge |

- Identifier: Indicates the identifier for matching request packets and response packets, which occupies one byte. The identifier values of request packets and response packets of the same type are the same.

- **Length:** Identifies the length of a whole RADIUS packet, which includes **Code, Identifier, Length, Authenticator,** and **Attributes**. It occupies two bytes. Bytes that are beyond the **Length** field will be truncated. If the length of a received packet is smaller than the value of **Length**, the packet is discarded.
- **Authenticator:** Verifies response packets of the RADIUS server by a RADIUS client, which occupies 16 bytes. This field is also used for encryption/decryption of user passwords.
- **Attributes:** Carries authentication, authorization, and accounting information, with the length unfixed. The **Attributes** field usually contains multiple attributes. Each attribute is represented in the Type, Length, Value (TLV) format. Type occupies one byte and indicates the attribute type. The following table lists common attributes of RADIUS authentication, authorization, and accounting. Length occupies one byte and indicates the attribute length, with the unit of bytes. Value indicates the attribute information.

| Attribute No. | Attribute Name | Attribute No. | Attribute Name |
|---------------|--------------------|---------------|------------------------|
| 1 | User-Name | 43 | Acct-Output-Octets |
| 2 | User-Password | 44 | Acct-Session-Id |
| 3 | CHAP-Password | 45 | Acct-Authentic |
| 4 | NAS-IP-Address | 46 | Acct-Session-Time |
| 5 | NAS-Port | 47 | Acct-Input-Packets |
| 6 | Service-Type | 48 | Acct-Output-Packets |
| 7 | Framed-Protocol | 49 | Acct-Terminate-Cause |
| 8 | Framed-IP-Address | 50 | Acct-Multi-Session-Id |
| 9 | Framed-IP-Netmask | 51 | Acct-Link-Count |
| 10 | Framed-Routing | 52 | Acct-Input-Gigawords |
| 11 | Filter-ID | 53 | Acct-Output-Gigawords |
| 12 | Framed-MTU | 55 | Event-Timestamp |
| 13 | Framed-Compression | 60 | CHAP-Challenge |
| 14 | Login-IP-Host | 61 | NAS-Port-Type |
| 15 | Login-Service | 62 | Port-Limit |
| 16 | Login-TCP-Port | 63 | Login-LAT-Port |
| 18 | Reply-Message | 64 | Tunnel-Type |
| 19 | Callback-Number | 65 | Tunnel-Medium-Type |
| 20 | Callback-ID | 66 | Tunnel-Client-Endpoint |
| 22 | Framed-Route | 67 | Tunnel-Server-Endpoint |
| 23 | Framed-IPX-Network | 68 | Acct-Tunnel-Connection |
| 24 | State | 69 | Tunnel-Password |
| 25 | Class | 70 | ARAP-Password |
| 26 | Vendor-Specific | 71 | ARAP-Features |
| 27 | Session-Timeout | 72 | ARAP-Zone-Access |
| 28 | Idle-Timeout | 73 | ARAP-Security |
| 29 | Termination-Action | 74 | ARAP-Security-Data |
| 30 | Called-Station-Id | 75 | Password-Retry |

| Attribute No. | Attribute Name | Attribute No. | Attribute Name |
|---------------|--------------------------|---------------|--------------------------|
| 31 | Calling-Station-Id | 76 | Prompt |
| 32 | NAS-Identifier | 77 | Connect-Info |
| 33 | Proxy-State | 78 | Configuration-Token |
| 34 | Login-LAT-Service | 79 | EAP-Message |
| 35 | Login-LAT-Node | 80 | Message-Authenticator |
| 36 | Login-LAT-Group | 81 | Tunnel-Private-Group-id |
| 37 | Framed-AppleTalk-Link | 82 | Tunnel-Assignment-id |
| 38 | Framed-AppleTalk-Network | 83 | Tunnel-Preference |
| 39 | Framed-AppleTalk-Zone | 84 | ARAP-Challenge-Response |
| 40 | Acct-Status-Type | 85 | Acct-Interim-Interval |
| 41 | Acct-Delay-Time | 86 | Acct-Tunnel-Packets-Lost |
| 42 | Acct-Input-Octets | 87 | NAS-Port-Id |

Shared Key

A RADIUS client and a RADIUS server mutually confirm their identities by using a shared key during communication. The shared key cannot be transmitted over a network. In addition, user passwords are encrypted for transmission for the sake of security.

RADIUS Server Group

The RADIUS security protocol, also called RADIUS method, is configured in the form of a RADIUS server group. Each RADIUS method corresponds to one RADIUS server group and one or more RADIUS servers can be added to one RADIUS server group. For details about the RADIUS method, see the *Configuring AAA*. If you add multiple RADIUS servers to one RADIUS server group, when the communication between a device and the first RADIUS server in this group fails or the first RADIUS server becomes unreachable, the device automatically attempts to communicate with the next RADIUS server till the communication is successful or the communication with all the RADIUS servers fails.

RADIUS Attribute Type

- Standard attributes

The RFC standards specify the RADIUS attribute numbers and attribute content but do not specify the format of some attribute types. Therefore, the format of attribute contents needs to be configured to adapt to different RADIUS server requirements. Currently, the format of the RADIUS Calling-Station-ID attribute (attribute No.: 31) can be configured.

The RADIUS Calling-Station-ID attribute is used to identify user identities when a network device transmits request packets to the RADIUS server. The RADIUS Calling-Station-ID attribute is a string, which can adopt multiple formats. It needs to uniquely identify a user. Therefore, it is often set to the MAC address of a user. For example, when IEEE 802.1X authentication is used, the Calling-Station-ID attribute is set to the MAC address of the device where the IEEE 802.1X client is installed. The following table describes the format of MAC addresses.

| Format | Description |
|-------------|--|
| ietf | Indicates the standard format specified in the IETF standard (RFC3580), which is separated by the separator (-). Example: 00-D0-F8-33-22-AC |
| Normal | Indicates the common format that represents a MAC address (dotted hexadecimal format), which is separated by the separator (.). Example: 00d0.f833.22ac |
| Unformatted | Indicates the format without separators. This format is used by default. Example: 00d0f83322ac |

- Private attributes

RADIUS is an extensible protocol. According to RFC2865, the Vendor-Specific attribute (attribute No.: 26) is used by device vendors to extend the RADIUS protocol to implement private functions or functions that are not defined in the standard RADIUS protocol. Table 1-3 lists private attributes supported by Ruijie products. The **TYPE** column indicates the default configuration of private attributes of Ruijie products and the **Extended TYPE** column indicates the default configuration of private attributes of other non-Ruijie products.

| ID | Function | TYPE | Extended TYPE |
|----|----------------------------|------|---------------|
| 1 | max-down-rate | 1 | 76 |
| 2 | port-priority | 2 | 77 |
| 3 | user-ip | 3 | 3 |
| 4 | vlan-id | 4 | 4 |
| 5 | last-supPLICANT-version | 5 | 5 |
| 6 | net-ip | 6 | 6 |
| 7 | user-name | 7 | 7 |
| 8 | password | 8 | 8 |
| 9 | file-directory | 9 | 9 |
| 10 | file-count | 10 | 10 |
| 11 | file-name-0 | 11 | 11 |
| 12 | file-name-1 | 12 | 12 |
| 13 | file-name-2 | 13 | 13 |
| 14 | file-name-3 | 14 | 14 |
| 15 | file-name-4 | 15 | 15 |
| 16 | max-up-rate | 16 | 16 |
| 17 | current-supPLICANT-version | 17 | 17 |
| 18 | flux-max-high32 | 18 | 18 |
| 19 | flux-max-low32 | 19 | 19 |
| 20 | proxy-avoid | 20 | 20 |
| 21 | dailup-avoid | 21 | 21 |
| 22 | ip-privilege | 22 | 22 |
| 23 | login-privilege | 42 | 42 |

| ID | Function | TYPE | Extended TYPE |
|-----|------------------------|------|---------------|
| 26 | ipv6-multicast-address | 79 | 79 |
| 27 | ipv4-multicast-address | 87 | 87 |
| 62 | sdg-type | 62 | 62 |
| 85 | sdg-zone-name | 85 | 85 |
| 103 | sdg-group-name | 103 | 103 |

Overview

| Feature | Description |
|--|--|
| RADIUS Authentication, Authorization, and Accounting | Conducts identity authentication and accounting on access users, safeguards network security, and facilitates management for network administrators. |
| Source Address of RADIUS Packets | Specifies the source IP address used by a RADIUS client to transmit packets to a RADIUS server. |
| RADIUS Timeout Retransmission | Specifies the packet retransmission parameter for a RADIUS client when a RADIUS server does not respond to packets transmitted from the RADIUS client within a period of time. |
| RADIUS Server Accessibility Detection | Enables a RADIUS client to actively detect whether a RADIUS server is reachable and maintain the accessibility of each RADIUS server. A reachable RADIUS server is selected preferentially to improve the handling performance of RADIUS services. |
| RADIUS Forced Offline | Enables a RADIUS server to actively force authenticated users to go offline. |

3.3.1 RADIUS Authentication, Authorization, and Accounting

Conduct identity authentication and accounting on access users, safeguard network security, and facilitate management for network administrators.

Working Principle

Figure 3-2

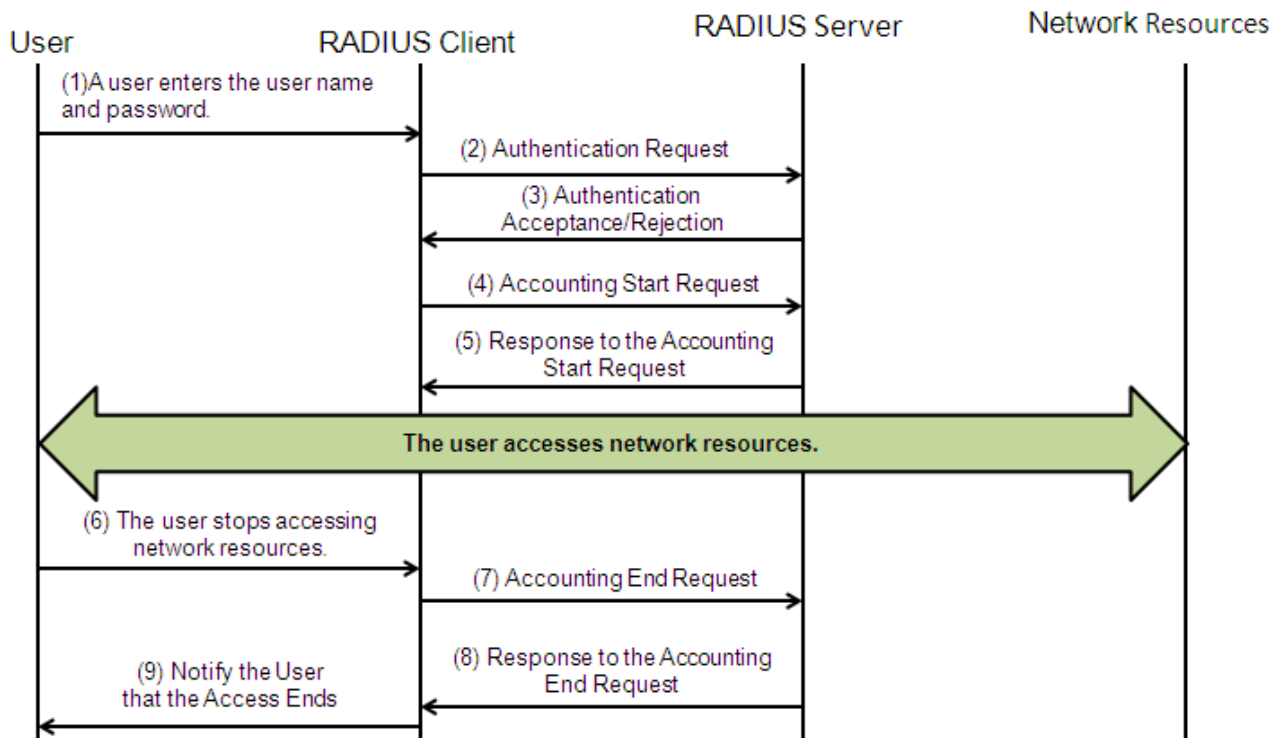

The RADIUS authentication and authorization process is described as follows:

1. A user enters the user name and password and transmits them to the RADIUS client.
2. After receiving the user name and password, the RADIUS client transmits an authentication request packet to the RADIUS server. The password is encrypted for transmission. For the encryption method, see RFC2865.
3. The RADIUS server accepts or rejects the authentication request according to the user name and password. When accepting the authentication request, the RADIUS server also issues authorization information apart from the authentication acceptance information. The authorization information varies with the type of access users.
4. The RADIUS accounting process is described as follows:
5. If the RADIUS server returns authentication acceptance information in Step (3), the RADIUS client sends an accounting start request packet to the RADIUS server immediately.
6. The RADIUS server returns the accounting start response packet, indicating accounting start.
7. The user stops accessing network resources and requests the RADIUS client to disconnect the network connection.
8. The RADIUS client transmits the accounting end request packet to the RADIUS server.
9. The RADIUS server returns the accounting end response packet, indicating accounting end.
10. The user is disconnected and cannot access network resources.

Related Configuration

↘ Configuring RADIUS Server Parameters

No RADIUS server is configured by default.

You can run the **radius-server host** command to configure a RADIUS server.

At least one RADIUS server must be configured so that RADIUS services run normally.

↘ Configuring the AAA Authentication Method List

No AAA authentication method list is configured by default.

You can run the **aaa authentication** command to configure a method list for different user types and select **group radius** when setting the authentication method.

The RADIUS authentication can be conducted only after the AAA authentication method list of relevant user types is configured.

↘ Configuring the AAA Authorization Method List

No AAA authorization method list is configured by default.

You can run the **aaa authorization** command to configure an authorization method list for different user types and select **group radius** when setting the authorization method.

The RADIUS authorization can be conducted only after the AAA authorization method list of relevant user types is configured.

↘ Configuring the AAA Accounting Method List

No AAA accounting method list is configured by default.

You can run the **aaa accounting** command to configure an accounting method list for different user types and select **group radius** when setting the accounting method.

The RADIUS accounting can be conducted only after the AAA accounting method list of relevant user types is configured.

3.3.2 Source Address of RADIUS Packets

Specify the source IP address used by a RADIUS client to transmit packets to a RADIUS server.

Working Principle

When configuring RADIUS, specify the source IP address to be used by a RADIUS client to transmit RADIUS packets to a RADIUS server, in an effort to reduce the workload of maintaining a large amount of NAS information on the RADIUS server.

Related Configuration

The global routing is used to determine the source address for transmitting RADIUS packets by default.

Run the **ip radius source-interface** command to specify the source interface for transmitting RADIUS packets. The device uses the first IP address of the specified interface as the source address of RADIUS packets.

3.3.3 RADIUS Timeout Retransmission

Working Principle

After a RADIUS client transmits a packet to a RADIUS server, a timer is started to detect the response of the RADIUS server. If the RADIUS server does not respond within a certain period of time, the RADIUS client retransmits the packet.

Related Configuration

↘ [Configuring the RADIUS Server Timeout Time](#)

The default timeout time is 5 seconds.

You can run the **radius-server timeout** command to configure the timeout time. The value ranges from 1 second to 1,000 seconds.

The response time of a RADIUS server is relevant to its performance and the network environment. Set an appropriate timeout time according to actual conditions.

↘ [Configuring the Retransmission Count](#)

The default retransmission count is 3.

You can run the **radius-server retransmit** command to configure the retransmission count. The value ranges from 1 to 100.

↘ [Configuring Whether to Retransmit Accounting Update Packets](#)

Accounting update packets are not retransmitted by default.

You can run the **radius-server account update retransmit** command to configure retransmission of accounting update packets for authenticated users.

3.3.4 RADIUS Server Accessibility Detection

Working Principle

A RADIUS client actively detects whether a RADIUS server is reachable and maintains the accessibility of each RADIUS server. A reachable RADIUS server is selected preferentially to improve the handling performance of RADIUS services.

Related Configuration

↘ [Configuring the Criteria for the Device to Judge That a RADIUS Server Is Unreachable](#)

The default criteria configured for judging that a RADIUS server is unreachable meet the two conditions simultaneously: 1. The device does not receive a correct response packet from the RADIUS security server within 60 seconds. 2. The device transmits the request packet to the same RADIUS security server for consecutive 10 times.

You can run the **radius-server dead-criteria** command to configure the criteria for the device to judge that the RADIUS security server is unreachable.

↘ [Configuring the Test User Name for Actively Detecting the RADIUS Security Server](#)

No test user name is specified for actively detecting the RADIUS security server by default.

You can run the **radius-server host x.x.x.xtestusername xxx** command to configure the test user name.

3.3.5 RADIUS Forced Offline

Working Principle

Figure 3-3 DM Message Exchange of the RADIUS Dynamic Authorization Extension Protocol

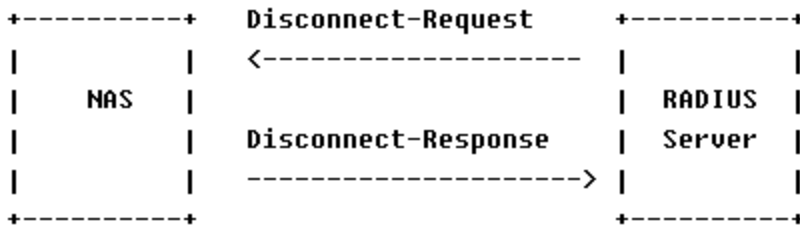

The preceding figure shows the exchange of DM messages between the RADIUS server and the device. The RADIUS server transmits the Disconnect-Request message to UDP Port 3799 of the device. After processing, the device returns the Disconnect-Response message that carries the processing result to the RADIUS server.

Related Configuration

N/A

3.3.6 Binding an Authentication Server

Working Principle

By binding a user to an authentication server, the user's authentication and accounting packets are sent to this server.



Related Configuration

↳ Binding an Authentication Server

Use the **radius-server account bind authen server** command to bind a user to an authentication server.

3.4 Configuration

| Configuration | Description and Command | |
|--|---|---|
| RADIUS Basic Configuration |  (Mandatory) It is used to configure RADIUS authentication, authorization, and accounting. | |
| | radius-serverhost | Configures the IP address of the remote RADIUS security server. |
| | radius-serverkey | Configures the shared key for communication between the device and the RADIUS server. |

| Configuration | Description and Command | |
|--|---|---|
| | radius-serverretransmit | Configures the request transmission count, after which the device confirms that a RADIUS server is unreachable. |
| | radius-servertimeout | Configures the waiting time, after which the device retransmits a request. |
| | radius-server account update retransmit | Configures retransmission of accounting update packets for authenticated users. |
| | ip radius source-interface | Configures the source address of RADIUS packets. |
| Configuring the RADIUS Attribute Type |  (Optional) It is used to define attribute processing adopted when the device encapsulates and parses RADIUS packets. | |
| | radius-serverattribute31 | Configures the MAC address format of RADIUS attribute No. 31 (Calling-Station-ID). |
| | radius-server attribute class | Configures the parsing mode of the RADIUS Class attribute. |
| | radius attribute | Configures the RADIUS private attribute type. |
| | radius set qoscos | Sets the private attribute port-priority issued by the server to the COS value of an interface. For COS-relevant concepts, see the <i>Configuring QoS</i> . |
| | radius support cui | Configures the device to support the CUI attribute. |
| | radius vendor-specific | Configures the mode of parsing private attributes by the device. |
| Configuring RADIUS Accessibility Detection |  (Optional) It is used to detect whether a RADIUS server is reachable and maintain the accessibility of the RADIUS server. | |
| | radius-server dead-criteria | Configures the global criteria for judging that a RADIUS security server is unreachable. |
| | radius-server deadtime | Configures the duration for the device to stop transmitting request packets to an unreachable RADIUS server. |
| | radius-server host | Configures the IP address of the remote RADIUS security server, authentication port, accounting port, and active detection parameters. |

3.4.1 RADIUS Basic Configuration

[Configuration Effect](#)

- RADIUS authentication, authorization, and accounting can be conducted after RADIUS basic configuration is complete.

[Notes](#)

- Before configuring RADIUS on the device, ensure that the network communication of the RADIUS server is in good condition.
- When running the **ip radius source-interface** command to configure the source address of RADIUS packets, ensure that the device of the source IP address communicates with the RADIUS server successfully.
- When conducting RADIUS IPv6 authentication, ensure that the RADIUS server supports RADIUS IPv6 authentication.

Configuration Steps

▾ Configuring the Remote RADIUS Security Server

- Mandatory.
- Configure the IP address, authentication port, accounting port, and shared key of the RADIUS security server.

▾ Configuring the Shared Key for Communication Between the Device and the RADIUS Server

- Optional.
- Configure a shared key in global configuration mode for servers without a shared key.

 The shared key on the device must be consistent with that on the RADIUS server.

▾ Configuring the Request Transmission Count, After Which the Device Confirms That a RADIUS Server Is Unreachable

- Optional.
- Configure the request transmission count, after which the device confirms that a RADIUS server is unreachable, according to the actual network environment.

▾ Configuring the Waiting Time, After which the Device Retransmits a Request

- Optional.
- Configure the waiting time, after which the device retransmits a request, according to the actual network environment.

 In an 802.1X authentication environment that uses the RADIUS security protocol, if a network device serves as the 802.1X authenticator and Ruijie SU is used as the 802.1X client software, it is recommended that **radius-server timeout** be set to 3 seconds (the default value is 5 seconds) and **radius-server retransmit** be set to 2 (the default value is 3) on the network device.

▾ Configuring Retransmission of Accounting Update Packets for Authenticated Users

- Optional.
- Determine whether to enable the function of retransmitting accounting update packets of authenticated users according to actual requirements.

▾ Configuring the Source Address of RADIUS Packets

- Optional.

- Configure the source address of RADIUS packets according to the actual network environment.

Verification

- Configure the AAA method list that specifies to conduct authentication, authorization, and accounting on users by using RADIUS.
- Enable the device to interact with the RADIUS server. Conduct packet capture to confirm that the device communicates with the RADIUS server over the RADIUS protocol.

Related Commands

▾ Configuring the Remote RADIUS Security Server

| | |
|------------------------------|--|
| Command | radius-server host [oob] { <i>ipv4-address</i> <i>ipv6-address</i> } [auth-port <i>port-number</i>] [acct-port <i>port-number</i>][test username <i>name</i> [idle-time <i>time</i>] [ignore-auth-port] [ignore-acct-port]] [key [0 7] <i>text-string</i>] |
| Parameter Description | <p>oob: Indicates oob authentication, that is, the source interface for transmitting packets to the RADIUS server is an mgmt port.</p> <p><i>ipv4-address</i>: Indicates the IPv4 address of the RADIUS security server.</p> <p><i>ipv6-address</i>: Indicates the IPv6 address of the RADIUS security server.</p> <p>auth-port<i>port-number</i>: Indicates the UDP port for RADIUS identity authentication. The value ranges from 0 to 65,535. If it is set to 0, the host does not conduct identity authentication.</p> <p>acct-port <i>port-number</i>: Indicates the UDP port for RADIUS accounting. The value ranges from 0 to 65,535. If it is set to 0, the host does not conduct accounting.</p> <p>test username <i>name</i>: Enables the function of actively detecting the RADIUS security server and specifies the user name used for active detection.</p> <p>idle-time<i>time</i>: Indicates the interval for the device to transmit test packets to a reachable RADIUS security server. The default value is 60 minutes. The value ranges from 1 minute to 1,440 minutes (24 hours).</p> <p>ignore-auth-port: Disables the function of detecting the authentication port of the RADIUS security server. It is enabled by default.</p> <p>ignore-acct-port: Disables the function of detecting the accounting port of the RADIUS security server. It is enabled by default.</p> <p>key [0 7] <i>text-string</i> : Configures the shared key of the server. The global shared key is used if it is not configured.</p> |
| Command Mode | Global configuration mode |
| Usage Guide | A RADIUS security server must be defined to implement the AAA security service by using RADIUS. You can run the radius-server host command to define one or more RADIUS security servers. If a RADIUS security server is not added to a RADIUS server group, the device uses the global routing table when transmitting RADIUS packets to the RADIUS server. Otherwise, the device uses the VRF routing table of the RADIUS server group. |

▾ Configuring the Shared Key for Communication Between the Device and the RADIUS Server

| | |
|------------------------------|---|
| Command | radius-server key [0 7] <i>text-string</i> |
| Parameter Description | <i>text-string</i> : Indicates the text of the shared key. 0 7 : Indicates the encryption type of the key. The value 0 indicates no encryption and 7 indicates simple encryption. The default value is 0 . |
| Command Mode | Global configuration mode |
| Usage Guide | A shared key is the basis for correct communication between the device and the RADIUS security server. The same shared key must be configured on the device and RADIUS security server so that they can communicate with each other successfully. |

↘ Configuring the Request Transmission Count, After Which the Device Confirms That a RADIUS Server Is Unreachable

| | |
|------------------------------|--|
| Command | radius-server retransmit <i>retries</i> |
| Parameter Description | <i>retries</i> : Indicates the RADIUS retransmission count. The value ranges from 1 to 100. |
| Command Mode | Global configuration mode |
| Usage Guide | The prerequisite for AAA to use the next user authentication method is that the current security server used for authentication does not respond. The criteria for the device to judge that a security server does not respond are that the security server does not respond within the RADIUS packet retransmission duration of the specified retransmission count. There is an interval between consecutive two retransmissions. |

↘ Configuring the Waiting Time, After which the Device Retransmits a Request

| | |
|------------------------------|---|
| Command | radius-server timeout <i>seconds</i> |
| Parameter Description | <i>seconds</i> : Indicates the timeout time, with the unit of seconds. The value ranges from 1 second to 1,000 seconds. |
| Command Mode | Global configuration mode |
| Usage Guide | Use this command to adjust the packet retransmission timeout time. |

↘ Configuring Retransmission of Accounting Update Packets for Authenticated Users

| | |
|------------------------------|--|
| Command | radius-server account update retransmit |
| Parameter Description | N/A |
| Command Mode | Global configuration mode |
| Usage Guide | Configure retransmission of accounting update packets for authenticated users. Accounting update packets are not retransmitted by default. The configuration does not affect users of other types. |

Configuration Example

↘ Using RADIUS Authentication, Authorization, and Accounting for Login Users

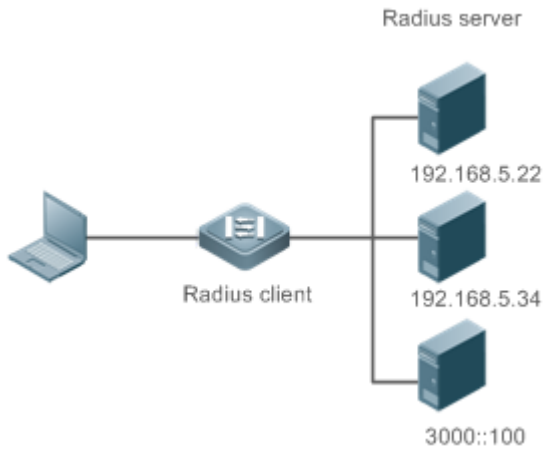
| | |
|--|--|
| <p>Scenario Figure 3-4</p> |  |
| <p>Configuration Steps</p> | <ul style="list-style-type: none"> ● Enable AAA. ● Configure the RADIUS server information. ● Configure to use the RADIUS authentication, authorization, and accounting methods. ● Apply the configured authentication method on the interface. |
| <p>RADIUS Client</p> | <pre>Ruijie#configure terminal Ruijie (config)#aaa new-model Ruijie (config)# radius-server host 192.168.5.22 Ruijie (config)#radius-server host 3000::100 Ruijie (config)# radius-server key aaa Ruijie (config)#aaa authentication login test group radius Ruijie (config)#aaa authorizationexec test group radius Ruijie (config)#aaa accountingexec test start-stop group radius Ruijie (config)# line vty 0 4 Ruijie (config-line)#login authentication test Ruijie (config-line)# authorization exec test Ruijie (config-line)# accounting exec test</pre> |
| <p>Verification</p> | <p>Telnet to a device from a PC. The screen requesting the user name and password is displayed. Enter the correct user name and password to log in to the device. After obtaining a certain access level granted by the server, only run commands under this access level. Display the authentication log of the user on the RADIUS server. Perform management operations on the device as the user and then log out. Display the accounting information on the user on the RADIUS server.</p> |
| | <pre>Ruijie#show running-config</pre> |

```
!  
radius-server host 192.168.5.22  
radius-server host 3000::100  
radius-server key aaa  
aaa new-model  
aaa accounting exec test start-stop group radius  
aaa authorization exec test group radius  
aaa authentication login test group radius  
no service password-encryption  
iptcp not-send-rst  
!  
vlan 1  
!  
line con 0  
line vty 0 4  
accounting exec test  
authorization exec test  
login authentication test  
!
```

Common Errors

- The key configured on the device is inconsistent with that configured on the server.
- No method list is configured.

3.4.2 Configuring the RADIUS Attribute Type

Configuration Effect

- Define the attribute processing adopted when the device encapsulates and parses RADIUS packets.

Notes

- Private attributes involved in "Configuring the RADIUS Attribute Type" refer to Ruijie private attributes.

Configuration Steps

- **Configuring the MAC Address Format of RADIUS Attribute No. 31 (Calling-Station-ID)**

- Optional.
- Set the MAC address format of **Calling-Station-Id** to a type supported by the server.
- ↳ **Configuring the Parsing Mode of the RADIUS Class Attribute**
- Optional.
- Configure the parsing mode of the Class attribute according to the server type.
- ↳ **Configuring the RADIUS Private Attribute Type**
- Optional.
- If the server is a Ruijie application server, the RADIUS private attribute type needs to be configured.
- ↳ **Setting the Private Attribute port-priority Issued by the Server to the COS Value of an Interface**
- Optional.
- Set the private attribute **port-priority** issued by the server to the COS value of an interface as required.
- ↳ **Configures the Device to Support the CUI Attribute**
- Optional.
- Configure whether the device supports the RADIUS CUI attribute as required.
- ↳ **Configuring the Mode of Parsing Private Attributes by the Device**
- Optional.
- Configure the index of a Ruijie private attribute parsed by the device as required.
- ↳ **Configuring Whether RADIUS Server Parses the Private Attribute of Cisco, Huawei or Microsoft**
- Optional.
- Configure whether RADIUS server parses the private attribute of Cisco, Huawei or Microsoft.

Verification

- Configure the AAA method list that specifies to conduct authentication, authorization, and accounting on users by using RADIUS.
- Enable the device to interact with the RADIUS server. Conduct packet capture to display the MAC address format of Calling-Station-Id.
- Enable the device to interact with the RADIUS server. Display the debug information of the device to check that Ruijie private attributes are correctly parsed by the device.
- Enable the device to interact with the RADIUS server. Display the debug information of the device to check that the CUI attribute is correctly parsed by the device.

Related Commands

Configuring the MAC Address Format of RADIUS Attribute No. 31 (Calling-Station-ID)

| | |
|------------------------------|--|
| Command | radius-server attribute 31 mac format {ietf normal unformatted } |
| Parameter Description | <p>ietf: Indicates the standard format specified in the IETF standard (RFC3580), which is separated by the separator (-). Example: 00-D0-F8-33-22-AC.</p> <p>normal: Indicates the common format that represents a MAC address (dotted hexadecimal format), which is separated by the separator (.). Example: 00d0.f833.22ac.</p> <p>unformatted: Indicates the format without separators. This format is used by default. Example: 00d0f83322ac.</p> |
| Command Mode | Global configuration mode |
| Usage Guide | Some RADIUS security servers (mainly used for 802.1X authentication) can identify only MAC addresses in the IETF format. In this case, set the MAC address format of Calling-Station-ID to IETF. |

Configuring the Parsing Mode of the RADIUS Class Attribute

| | |
|------------------------------|--|
| Command | radius-server attribute class user-flow-control { format-16bytes format-32bytes } |
| Parameter Description | <p>user-flow-control: Parses the rate limit configuration from the class attribute.</p> <p>format-16bytes: Sets the format of the rate limit value to 16 bytes in the class attribute.</p> <p>format-32bytes: Sets the format of the rate limit value to 32 bytes in the class attribute.</p> |
| Command Mode | Global configuration mode |
| Usage Guide | Configure this command if the server needs to issue the rate limit value by using the Class attribute. |

Configuring the RADIUS Private Attribute Type

| | |
|------------------------------|--|
| Command | radius attribute { id down-rate-limit dscp mac-limit up-rate-limit } vendor-type type |
| Parameter Description | <p><i>id</i>: Indicates a function ID <1-255>.</p> <p><i>type</i>: Indicates the private attribute type.</p> <p>down-rate-limit: Indicates the downstream rate limit.</p> <p>dscp: Indicates DSCP attribute.</p> <p>mac-limit: Indicates MAC-limit attribute.</p> <p>up-rate-limit: Indicates the upstream rate limit.</p> |
| Command Mode | Global configuration mode |
| Usage Guide | Run this command to configure the RADIUS private attribute type. |

Setting the Private Attribute port-priority Issued by the Server to the COS Value of an Interface

| | |
|------------------------------|---------------------------|
| Command | radius set qos cos |
| Parameter Description | N/A |

| | |
|---------------------|--|
| Command Mode | Global configuration mode |
| Usage Guide | Configure this command to use the issued QoS value as the CoS value. The QoS value is used as the DSCP value by default. |

↘ Configures the Device to Support the CUI Attribute

| | |
|------------------------------|--|
| Command | radius support cui |
| Parameter Description | N/A |
| Command Mode | Global configuration mode |
| Usage Guide | Configure this command to enable the RADIUS-compliant device to support the CUI attribute. |

↘ Configuring the Mode of Parsing Private Attributes by the Device

| | |
|------------------------------|--|
| Command | radius vendor-specific extend |
| Parameter Description | N/A |
| Command Mode | Global configuration mode |
| Usage Guide | Use this command to identify attributes of all vendor IDs by type. |

↘ Configuring Whether RADIUS Server Parses the Private Attribute of Cisco, Huawei or Microsoft

| | |
|------------------------------|---|
| Command | radius vendor-specific attribute support <i>vendor_name</i> |
| Parameter Description | <i>vendor_name</i> : Indicates the vendor name. It can be set to cisco, huawei or ms. |
| Command Mode | Global configuration mode |
| Usage Guide | Use this command to configure whether RADIUS server parses the private attribute of Cisco, Huawei or Microsoft. |

Configuration Example

↘ Configuring the RADIUS Attribute Type

| | |
|----------------------------|---|
| Scenario | One authentication device |
| Configuration Steps | <ul style="list-style-type: none"> ● Configure the MAC address format of RADIUS Calling-Station-Id. ● Configure the RADIUS private attribute type. ● Set the QoS value issued by the RADIUS server as the COS value of the interface. ● Configure the RADIUS function to support the CUI attribute. ● Configure the device to support private attributes of other vendors. |

| | |
|---------------------|---|
| | <ul style="list-style-type: none"> ● Configure the RADIUS server not to parse Cisco's private attributes contained in packets. |
| | <pre>Ruijie(config)#radius-server attribute 31 mac format ietf Ruijie(config)#radius attribute 16 vendor-type 211 Ruijie(config)#radiussetqoscos Ruijie(config)#radiussupport cui Ruijie(config)#radiusvendor-specific extend Ruijie(config)# no radius vendor-specific attribute support cisco</pre> |
| Verification | Conduct packet capture or display debug information of the device to check whether the RADIUS standard attributes and private attributes are encapsulated/parsed correctly. |

3.4.3 Configuring RADIUS Accessibility Detection

Configuration Effect

The device maintains the accessibility status of each configured RADIUS server: reachable or unreachable. The device will not transmit authentication, authorization, and accounting requests of access users to an unreachable RADIUS server unless all the other servers in the same RADIUS server group as the unreachable server are all unreachable.

The device actively detects a specified RADIUS server. The active detection function is disabled by default. If the active detection function is enabled for a specified RADIUS server, the device will, according to the configuration, periodically transmits detection requests (authentication requests or accounting requests) to the RADIUS server. The transmission interval is as follows:

- For a reachable RADIUS server, the interval is the active detection interval of the reachable RADIUS server (the default value is 60 minutes).
- For an unreachable RADIUS server, the interval is always 1 minute.

Notes

All the following conditions need to be met before the active detection function is enabled for a specified RADIUS server:

- The test user name of the RADIUS server is configured on the device.
- At least one tested port (authentication port or accounting port) of the RADIUS server is configured on the device.

If the following two conditions are all met, it is deemed that a reachable RADIUS server becomes unreachable:

- After the previous correct response is received from the RADIUS server, the time set in **radius-server dead-criteria time seconds** has elapsed.
- After the previous correct response is received from the RADIUS server, the count that the device transmits requests to the RADIUS server but fails to receive correct responses (including retransmission) reaches the value set in **radius-server dead-criteria tries number**.

If any of the following conditions is met, it is deemed that an unreachable RADIUS server becomes reachable:

- The device receives correct responses from the RADIUS server.
- The duration that the RADIUS server is in the unreachable state exceeds the time set in **radius-server deadtime** and the active detection function is disabled for the RADIUS server.
- The authentication port or accounting port of the RADIUS server is updated on the device.

Configuration Steps

▾ Configuring the Global Criteria for Judging That a RADIUS Security Server Is Unreachable

- Mandatory.
- Configuring the global criteria for judging that a RADIUS security server is unreachable is a prerequisite for enabling the active detection function.

▾ Configuring the IP Address of the Remote RADIUS Security Server, Authentication Port, Accounting Port, and Active Detection Parameters

- Mandatory.
- Configuring active detection parameters of the RADIUS server is a prerequisite for enabling the active detection function.

▾ Configuring the Duration for the Device to Stop Transmitting Request Packets to an Unreachable RADIUS Server

- Optional.
- The configured duration for the device to stop transmitting request packets to an unreachable RADIUS server takes effect only when the active detection function is disabled for the RADIUS server.

Verification

- Run the **show radius server** command to display the accessibility information of each RADIUS server.

Related Commands

▾ Configuring the Global Criteria for Judging That a RADIUS Security Server Is Unreachable

| | |
|------------------------------|--|
| Command | radius-server dead-criteria { <i>timeseconds</i> [<i>triesnumber</i>] <i>triesnumber</i> } |
| Parameter Description | <p>timeseconds: Indicates the time condition parameter. If the device fails to receive a correct response packet from a RADIUS security server within the specified time, it is deemed that the RADIUS security server meets the inaccessibility duration condition. The value ranges from 1 second to 120 seconds.</p> <p>triesnumber: Indicates the consecutive request timeout count. If the timeout count of request packets transmitted by the device to the same RADIUS security server reaches the preset count, it is deemed that the RADIUS security server meets the consecutive timeout count condition of inaccessibility. The value ranges from 1 to 100.</p> |
| Command | Global configuration mode |

| | |
|--------------------|--|
| Mode | |
| Usage Guide | If a RADIUS security server meets both the duration condition and the consecutive request timeout count condition, it is deemed that the RADIUS security server is unreachable. Users can use this command to adjust parameter values in the duration condition and consecutive request timeout count condition. |

↘ **Configuring the Duration for the Device to Stop Transmitting Request Packets to an Unreachable RADIUS Server**

| | |
|------------------------------|---|
| Command | radius-server deadtime <i>minutes</i> |
| Parameter Description | <i>minutes</i> : Indicates the duration for the device to stop transmitting requests to an unreachable RADIUS security server, with the unit of minutes. The value ranges from 1 minute to 1,440 minutes (24 hours). |
| Command Mode | Global configuration mode |
| Usage Guide | If the active detection function is enabled for a RADIUS security server on the device, the time parameter in radius-server deadtime does not take effect on the RADIUS server. If the active detection function is disabled for a RADIUS security server, the device automatically restores the RADIUS security server to the reachable state when the duration that the RADIUS security server is in the unreachable state exceeds the time specified in radius-server deadtime . |

Configuration Example

↘ **Configuring Accessibility Detection on the RADIUS Server**

| | |
|-------------------------------|--|
| Scenario Figure 3-5 | <p style="text-align: center;">192.168.5.22</p> <p style="text-align: center;">Radius client Radius server</p> |
| Configuration Steps | <ul style="list-style-type: none"> ● Configure the global criteria for judging that a RADIUS security server is unreachable. ● Configure the IP address of the remote RADIUS security server, authentication port, accounting port, and active detection parameters. |
| RADIUS Client | <pre>Ruijie(config)#radius-server dead-criteria time120 tries 5 Ruijie(config)# radius-server host 192.168.5.22 test username test ignore-acct-port idle-time 90</pre> |
| Verification | <p>Disconnect the network communication between the device and the server with the IP address of 192.168.5.22. Conduct RADIUS authentication through the device. After 120 seconds, run the show radius server command to check that the server state is dead.</p> |
| | <pre>Ruijie#show running-config ... radius-server host 192.168.5.22 test username test ignore-acct-port idle-time 90 radius-server dead-criteria time 120 tries 5</pre> |

| | |
|--|-----|
| | ... |
|--|-----|

3.5 Monitoring

Clearing

 Running the **clear** commands may lose vital information and thus interrupt services.

| Description | Command |
|---|--|
| Clears statistics of the RADIUS dynamic authorization extension function and restarts statistics. | clear radius dynamic-authorization-extension statistics |

Displaying

| Description | Command |
|--|---|
| Displays global parameters of the RADIUS server. | show radius parameter |
| Displays the configuration of the RADIUS server. | show radius server |
| Displays the configuration of the RADIUS private attribute type. | show radius vendor-specific |
| Displays statistics relevant to the RADIUS dynamic authorization extension function. | show radius dynamic-authorization-extension statistics |
| Displays statistics relevant to RADIUS authentication. | show radius auth statistics |
| Displays statistics relevant to RADIUS accounting. | show radius acct statistics |
| Displays configuration of RADIUS server groups. | show radius group |

Debugging

 System resources are occupied when debugging information is output. Therefore, disable debugging immediately after use.

| Description | Command |
|---|------------------------------------|
| Debugs the RADIUS event. | debugradiusevent |
| Debugs RADIUS packet printing. | debugradiusdetail |
| Debugs the RADIUS dynamic authorization extension function. | debug radiusextension event |

| | |
|--|--------------------------------------|
| Debugs the RADIUS dynamic authorization extension packet printing. | debug radius extension detail |
|--|--------------------------------------|

4 Configuring 802.1X

4.1 Overview

IEEE 802.1X is an STAndard for port-based network access control that provides secure access service for local area networks (LANs).

In IEEE 802-compliant LANs, users connecting to the network access devices (NASs) can access network resources without authentication and authorization, bringing security risks to the network. IEEE 802.1X was proposed to resolve security problems of such LANs.

802.1X supports three security applications: authentication, authorization, and accounting, which are called AAA.

- Authentication: Checks whether to allow user access and restricts unauthorized users.
- Authorization: Grants specified services to users and controls permissions of authorized users.
- Accounting: Records network resource status of users to provide statistics for charges.

802.1X can be deployed in a network to realize user authentication, authorization and other functions.

Protocols and Standards

- IEEE 802.1X: Port-Based Network Access Control

4.2 Applications

| Application | Description |
|--|--|
| Wireless 802.1X Authentication | When an enterprise deploys a wireless LAN (WLAN), 802.1X authentication should be enabled on the Access Controller (AC). |

4.2.1 Wireless 802.1X Authentication

Scenario

An enterprise deploys a fit-AP wireless authentication environment including fit Access Points (APs) and an AC. 802.1X is deployed for secure admission. Wireless stations or devices (STAs) should pass 802.1X authentication to access the enterprise network.

As shown in Figure 4-1:

- STAs are installed with 802.1X clients (which can come with the operating system, or others like Ruijie Supplicant).
- The AC supports 802.1X.
- One or multiple RADIUS servers perform authentication.

Figure 4-1

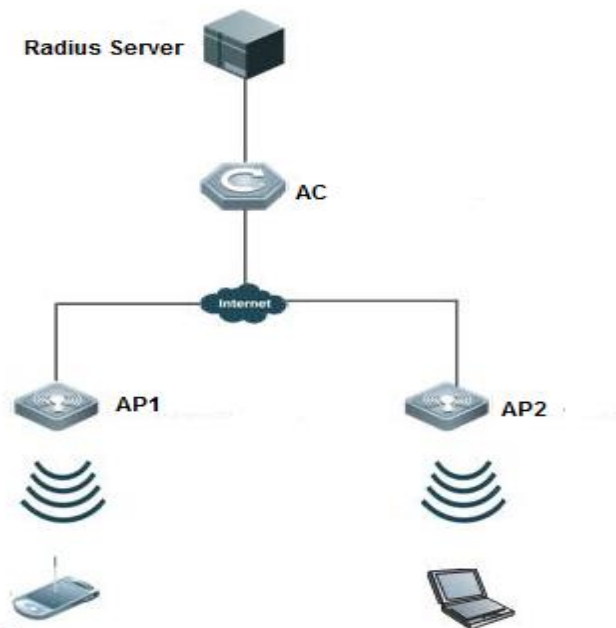

| | |
|----------------|---|
| Remarks | STAs support 802.1X authentication. After connecting to APs, they will be authenticated through 802.1X. 802.1X authentication is enabled on the AC. The RADIUS server runs the RADIUS server software to perform identity verification. |
|----------------|---|

Deployment

- Enable 802.1X authentication on the AC based on the WLANs broadcast by APs to make associated STAs controlled. Only authenticated STAs can access the network.
- Configure an AAA authentication method list so that 802.1X can adopt the appropriate method and authentication server.
- Configure RADIUS parameters to ensure proper communication between the AC and the RADIUS server. For details, see the *Configuring RDS*.
- If a Ruijie RADIUS server is used, configure SNMP parameters to allow the RADIUS server to manage devices, such as querying and setting.
- Create an account on the RADIUS server, register the IP addresses of the AC, and configure RADIUS-related parameters. Only in this case, can the RADIUS server respond to the requests of the AP/AC.

4.2.2 MAB Auto Authentication

Scenario

MAC address bypass (MAB) auto authentication indicates that MAB authentication is performed together with Web authentication. In the original wireless Web authentication scenario, it is complained that the ease-to-use performance of Web authentication is poor. During each Web authentication, a user needs to associate the STA with an SSID, open the

browser, and enter the user name and password. In addition, if the STA drops out of the network, the STA cannot automatically access the network again. To ensure that all Web authenticated STAs are always online and access the network imperceptibly, MAB auto authentication is proposed. After a STA passes Web authentication, the STA can access the network again imperceptibly without Web authentication.

As shown in Figure 4-1:

- Only the browser is mandatory on the client.
- The AC supports Web authentication and MAB authentication.
- One or multiple RADIUS servers provide authentication. In addition, the authentication server supports the authentication mode of using the MAC address as the user name and password.

Figure 4-2

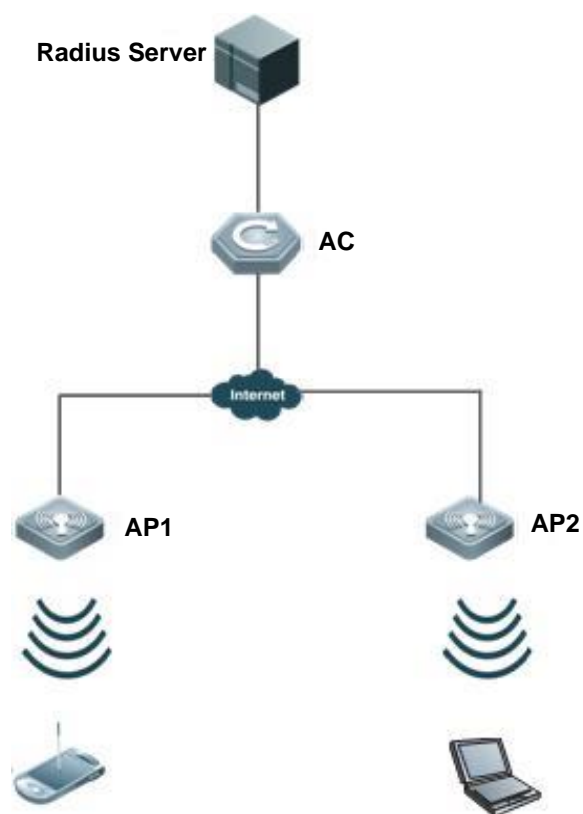

| | |
|----------------|--|
| Remarks | Wireless MAB authentication is triggered by a STA advertisement. When a STA is already online, MAB authentication will not be triggered again. If MAB authentication fails, it can be triggered again only after the STA goes offline and reconnects to the network. |
|----------------|--|

Deployment

- Enable Web authentication, DOT1X authentication, and MAB authentication on the interface of the AC. MAB authentication can be performed only after DOT1X authentication is enabled. (For details about MAB authentication,

see section 4.4.4 "Configuring MAB Auto Authentication". For details about Web authentication, see the WEB-AUTH-SCG document.)

- Configure an AAA authentication method list, so that a correct method and authentication server can be used for MAB/Web authentication. (For details about the AAA authentication method list configuration, see the AAA-SCG document.)
- Configure RADIUS parameters to ensure proper communication between the AC and the RADIUS server. In addition, configure the RADIUS server to support the authentication mode of using the MAC address as the user name and password. For details about the RADIUS configuration, see the corresponding configuration guide.
- If a Ruijie RADIUS server is used, configure SNMP parameters to allow the RADIUS server to perform operations such as querying and setting on the AP.
- Create an account on the RADIUS server, register the IP address of the AC, and configure RADIUS-related parameters. The RADIUS server can respond to the requests of the AP and AC only after the foregoing settings are completed.

4.3 Features

Basic Concepts

↘ User

802.1X is a LAN-based protocol. It identifies users based on physical information but not accounts. Except them, all other information such as the account ID and IP address can be changed. In WLANs, one MAC address represents an STA.

↘ RADIUS

RADIUS is a remote authentication protocol defined in RFC2865, which get wide practice. Using this protocol, the authentication server can remotely deploy and perform authentication. During 802.1X deployment, the authentication server is remotely deployed, and 802.1X authentication information between the NAS and the authentication server is transmitted through RADIUS.

↘ Timeout

During authentication, an NAS needs to communicate with the authentication client and server. If the authentication client or server times out, not responding within the time specified by 802.1X, authentication will fail. During deployment, ensure that the timeout specified by 802.1X is longer than that specified by RADIUS.

↘ MAB

MAC address bypass (MAB) authentication means that the MAC address is used as the user name and password for authentication. Since Ruijie Supplicant cannot be installed on some dumb ends such as network printers, use MAB to perform security control.

↘ EAP

802.1X uses Extensible Authentication Protocol (EAP) to carry authentication information. Defined in RFC3748, EAP provides a universal authentication framework, in which multiple authentication modes are embedded, including Message Digest Algorithm 5 (MD5), Challenge Handshake Authentication Protocol (CHAP), Password Authentication Protocol (PAP), and Transport Layer Security (TLS). Ruijie 802.1X authentication supports various modes including MD5, CHAP, PAP, PEAP-MSCHAP, and TLS.

↘ Authorization

Authorization means to bind specified services to authenticated users, such as VLAN and Access Control List (ACL).

↘ Accounting

Accounting performs network audit on network usage duration and traffic for users, which facilitates network operation, maintenance, and management.

i Some RADIUS servers such as RG-SAM\RG-SMP servers need to check the online/offline status based on accounting packets. Therefore, accounting must be enabled on these RADIUS servers.

Overview

| Feature | Description |
|--------------------------------|---|
| Authentication | Provides secure admission for users. Only authenticated users can access the network. |
| Authorization | Grants network access rights to authenticated users, such as IP address binding and ACL binding |
| Accounting | Provides online record audit, such as online duration and traffic. |

4.3.1 Authentication

Authentication aims to check whether users are authorized and prevent unauthorized users from accessing the network. Users must pass authentication to obtain the network access permission. They can access the network only after the authentication server verifies the account. Before user authentication succeeds, only EAPOL packets (Extensible Authentication Protocol over LAN, 802.1X packets) can be transmitted over the network for authentication.

Working Principle

802.1X authentication is very simple. After a user submits its account information, the NAS sends the account information to the remote RADIUS server for identity authentication. If the authentication succeeds, the user can access the network.

↘ Roles in Authentication

802.1X authentication involves three roles: supplicant, authenticator, and server. In real applications, their respective roles are client, network access server (NAS), and authentication server (mostly RADIUS server).

Figure 4-3

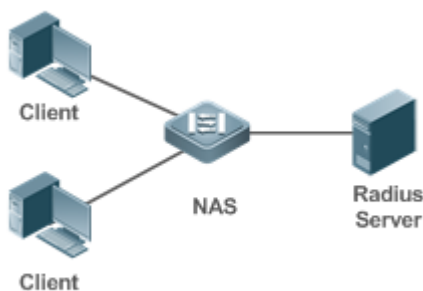

- Supplicant

The supplicant is the role of end users, usually a PC. It requests to access network services and replies to the request packets of the authenticator. The supplicant must run software compliant with the 802.1X standard. Except the typical 802.1X client support embedded in the operating system, Ruijie has launched a Ruijie Supplicant compliant with the 802.1X standard.

- Authenticator

The authenticator is usually an NAS such as a switch or wireless access hotspot. It controls the network connection of a client based on the client's authentication status. As a proxy between the client and the authentication server, the authenticator requests the user name from the client, verifies the authentication information from the authentication server, and forwards it to the client. Except as the 802.1X authenticator, the so-called NAS also acts as a RADIUS Client. It encapsulates the replies of the client into the RADIUS-format packets and forwards the packets to the RADIUS server. After receiving the information from the RADIUS server, it interprets the information and forwards it to the client.

The authenticator has two types of ports: controlled port and uncontrolled port. Users connected to controlled ports can access network resources only when authenticated. Users connected to uncontrolled ports can directly access network resources without authentication. We can connect users to controlled ports to control users. Uncontrolled ports are mainly used to connect the authentication server to ensure proper communication between the authentication server and the NAS.

- Authentication server

The authenticator server is usually an RADIUS server. It cooperates with the authenticator to provide authentication service for users. The authentication server saves the user names, passwords, and related authorization information. One server can provides authentication service for multiple authenticators to achieve centralized user management. The authentication server also manages accounting data received from authenticators. Ruijie RADIUS servers compliant with 802.1X standard include Microsoft IAS/NPS, Free RADIUS Server, and Cisco ACS.

▾ Authentication Process and Packet Exchange

The supplicant exchanges information with the authenticator through EAPOL while exchanges information with the authentication server through RADIUS. EAPOL is encapsulated on the MAC layer, with the type number of 0x888E. IEEE assigned a multicast MAC address 01-80-C2-00-00-03 for EAPOL to exchange packets during initial authentication. Ruijie Supplicant may also use 01-D0-F8-00-00-03 to for initial authentication packets.

Figure 4-4 shows the typical authentication process of a wired user.

Figure 4-4

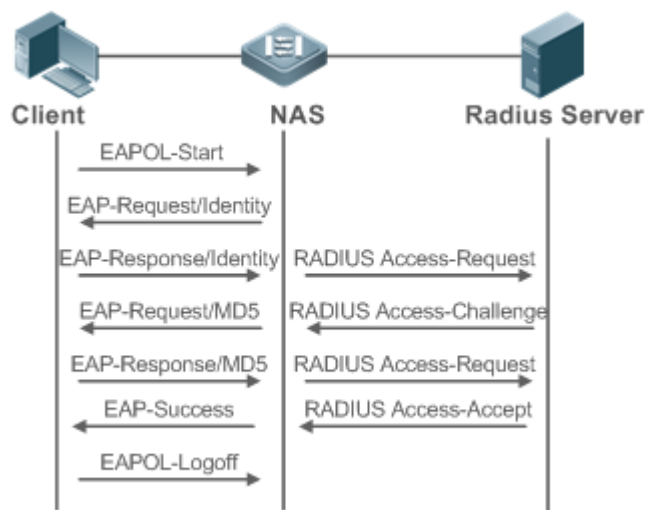

This is a typical authentication process initiated by a user. In special cases, the NAS, may take place of the user to initiate an authentication request.

Authenticating User Status

802.1X determines whether a user on a port can access the network based on the authentication status of the port. Ruijie products extend the 802.1X and realizes access control based on users (identify a wired user by the MAC address and VLAN ID while an STA by the MAC address) by default. Ruijie 802.1X can also be enabled in interface configuration mode. For details, see the chapter "Configuration."

All users on an uncontrolled port can access network resources, while users on a controlled port can access network resources only after authorized. When a user initiates authentication, its status remains Unauthorized and cannot access the network yet. After it passes authentication, its status changes to Authorized and can access network resources.

If the user connected to a controlled port does not support 802.1X, it will not respond to the NAS requesting the user name of the user. That means, the user remains Unauthorized and cannot access network resources.

In the case of 802.1X-enabled user and 802.1X-disabled NAS, if the user does not receive any responses after sending a specified number of EAPOL-Start packets, it regards the connected port uncontrolled and directly accesses network resources.

On 802.1X-enabled devices, all ports are uncontrolled by default. We can configure a port as controlled so that all users on this port have to be authorized.

If a user passes authentication (that is, the NAS receives a success packet from the RADIUS server), the user becomes Authorized and can freely access network resources. If the user fails in authentication, it remains Unauthorized and re-initiates authentication. If the communication between the NAS and the RADIUS server fails, the user remains Unauthorized and cannot access network resources.

When a user sends an EAPOL-LOGOFF packet, the user's status changes from Authorized to Unauthorized.

When the NAS restarts, all users on it become Unauthorized.

If you want to forcibly make a client free from authentication, it is recommended to add an STAtic MAC address.

📌 Deploying the Authentication Server

802.1X authentication uses the RADIUS server as the authentication server. Therefore, when 802.1X secure admission is deployed, the RADIUS server also needs to be deployed. Common RADIUS servers include Microsoft IAS/NPS, Cisco ACS, and RG-SAM/SMP. For details about the deployment procedure, see related software description.

📌 Configuring Authentication Parameters

To use 802.1X authentication, enable 802.1X authentication on the access port and configure AAA authentication method list and RADIUS server parameters. To ensure the accessibility between the NAS and RADIUS server, the 802.1X server timeout should be longer than the RADIUS server timeout.

📌 Supplicant

A user should start Ruijie Supplicant to enter the user name and initiate authentication. If the operating system brings an own authentication client and the network is available, a dialog box will be displayed, asking the user to enter the user name. Different clients may have different implementation processes and Graphical User Interfaces (GUIs). It is recommended to use Ruijie Supplicant as the authentication client. If other software is used, see related software description.

📌 Offline

If a user does not want to access the network, it can choose to go offline by multiple approaches, such as powering off the device, connecting the port to the network, and offline function provided by some supplicants.

📌 VLAN Hopping

After passing 802.1X authentication, a user is added to the VLAN assigned by the server. Then the user is allowed to communicate within that VLAN.

4.3.2 Authorization

After a user passes authentication, the NAS restricts the accessible network resources of the user in multiple approaches, such as accessible VLANs

Working Principle

Authorization means to bind the permissions with the users. A user is identified based on the MAC address and VLAN ID, as mentioned before. Besides MAC-VID binding, some other information such as the IP address and VLAN ID are bound with a user to implement authorization.

📌 ACL Authorization

After user authentication is complete, the authentication server delivers the ACL or ACE to users. The ACL must be configured on the authentication server before delivery while no extra configuration is required for ACE delivery. ACL

authorization delivers the ACL based on RADIUS attributes such as standard attributes, Ruijie-proprietary attributes, and Cisco-proprietary attributes. For details, see the software description related to the RADIUS server.

↘ Kickoff

Used with RG-SAM/SMP, Ruijie 802.1X server can kick off online users who will be disconnected with the network. This function applies to the environment where the maximum online period and real-time accounting check function are configured.

4.3.3 Accounting

Accounting allows the network operators to audit the network access or fees of accessed users, including the online time and traffic.

Working Principle

Accounting is enabled on the NAS. The RADIUS server supports RFC2869-based accounting. When a user goes online, the NAS sends an accounting start packet to the RADIUS server which then starts accounting. When the user goes offline, the NAS sends an accounting end packet to the RADIUS server which then completes the accounting and generates a network fee accounting list. Different servers may perform accounting in different ways. Moreover, not all servers support accounting. Therefore, refer to the usage guide of the authentication server during actual deployment and accounting.

↘ Accounting Start

After a user passes authentication, the accounting-enabled switch sends the RADIUS server an accounting start packet carrying user accounting attributes such as user name and accounting ID. After receiving the packet, the RADIUS server starts accounting.

↘ Accounting Update





The NAS periodically sends Accounting Update packets to the RADIUS server, making the accounting more real-time. The accounting update interval can be provided by the RADIUS server or configured on the NAS.

↘ Accounting End

After a user goes offline, the NAS sends the RADIUS server an accounting end packet carrying the online period and traffic of the user. The RADIUS server generates online records based on the information carried in this packet.

4.4 Configuration

| Configuration | Description and Command | |
|--|--|---|
| Configuring 802.1X Basic Functions |  (Mandatory) It is used to configure basic authentication and accounting. | |
| | <code>aaa new-model</code> | Enables AAA. |
| | <code>aaa authentication dot1x</code> | Configures an AAA authentication method list. |

| | | |
|--|---|---|
| | aaa accounting networks | Configures an AAA accounting method list. |
| | radius-server host | Configures the RADIUS server parameters. |
| | radius-server key | Configures the preshared key for communication between the NAS and the RADIUS server. |
| Configuring 802.1X Parameters |  (Optional) It is used to configure 802.1X parameters.  Ensure that the 802.1X server timeout is longer than the RADIUS server timeout.  Online Ruijie client detection applies only to Ruijie Supplicant. | |
| | dot1x re-authentication | Enables re-authentication. |
| | dot1x timeout re-authperiod | Configures the re-authentication interval. |
| | dot1x timeout tx-period | Configures the interval of EAP-Request/Identity packet retransmission. |
| | dot1x reauth-max | Configures the maximum times of EAP-Request/Identity packet retransmission. |
| | dot1x timeout supp-timeout | Configures the interval of EAP-Request/Challenge packet retransmission. |
| | dot1x max-req | Configures the maximum times of EAP-Request/Challenge packet retransmission. |
| | dot1x timeout server-timeout | Configures the authentication server timeout. |
| | dot1x timeout quiet-period | Configures the quiet period after authentication fails. |
| | dot1x auth-mode | Specifies the authentication mode (EAP/CHAP/PAP). |
| Configuring MAB |  (Optional) It is used to configure MAC Authentication Bypass (MAB). | |
| | dot1x mab | Configures wireless MAB. |
| | dot1x mab-username upper | Enables uppercase letters in MAB user names. |
| Configuring Extended Functions |  (Optional) It is used to configure multiple accounts for the same MAC address. | |
| | dot1x multi-account enable | Enables multi-account authentication with one MAC address. |
| | dot1x valid-ip-acct enable | Enables IP-triggered accounting. |

| | | |
|--|--|---|
| | dot1x valid-ip-acct timeout | Configures the timeout of obtaining IP addresses after users get authenticated. If timeout is reached, they will be kicked off. |
| | dot1x event server-invalid action bypass-wlan | Configures the bypass WLAN for the RADIUS server. |
| | dot1x encryption only | Configures 802.1X authentication for encryption only when 802.1X and Web authentication are both enabled. |
| | dot1x logging rate-limit | Limits the rate of printing online and offline logs. |
| | dot1x offline-detect | Enables traffic detection on users in WLAN. |
| | dot1x user-trap enable | Enables SNMP trap during online and offline. |

4.4.1 Configuring 802.1X Basic Functions

Configuration Effect

- Enable basic authentication and accounting services.
- On a wired network, run the **dot1x port-control auto** command in interface configuration mode to enable 802.1X authentication on a port.
- Run the **radius-server host ip-address** command to configure the IP address and port information of the RADIUS server and the **radius-server key** command to configure the RADIUS communication key between the NAS and the RADIUS server to ensure secure communication.
- Run the **aaa accounting update** command in global configuration mode to enable accounting update and the **aaa accounting update interval** command on the NAS to configure the accounting update interval. If the RADIUS server supports accounting update, you can also configure it on the RADIUS server. Prefer to use the parameters assigned by the authentication server than the parameters configured on the NAS.

Notes

- Configure accurate RADIUS parameters so that the basic RADIUS communication is proper.
- The 802.1X authentication method list and accounting method list must be configured in AAA. Otherwise, errors may occur during authentication and accounting.
- 802.1X uses the default method list by default. If the default method list is not configured for AAA, run the **dot1x authentication** and **dot1x accounting** commands to reconfigure the it.
- When RG-SAM/SMP is used, accounting must be enabled. Otherwise, the RADIUS server will fail to detect users going offline, causing offline users remaining in the online user table.

Configuration Steps

▾ Enabling AAA

- (Mandatory) 802.1X authentication and accounting take effect only after AAA is enabled.
- Enable AAA on the NAS that needs to control user access by 802.1X.

| | |
|------------------------------|--|
| Command | aaa new-model |
| Parameter Description | N/A |
| Defaults | AAA is disabled by default. |
| Command Mode | Global configuration mode |
| Usage Guide | AAA is disabled by default. This command is mandatory for the deployment of 802.1X authentication. |

▾ Enabling an AAA Authentication Method List

- Mandatory.
- The AAA authentication method list must be consistent with the 802.1X authentication method list.
- Enable an AAA authentication method list after 802.1X authentication is enabled on the NAS.

| | |
|------------------------------|--|
| Command | aaa authentication dot1x <i>list-name</i> group radius |
| Parameter Description | <i>list-name</i> : Indicates the 802.1X authentication method list of AAA. |
| Defaults | No AAA authentication method list is configured by default. |
| Command Mode | Global configuration mode |
| Usage Guide | AAA authentication modes are disabled by default. The AAA authentication mode must be consistent with the 802.1X authentication mode. |

▾ Configuring the RADIUS Server Parameters

- (Mandatory) The RADIUS server parameters must be configured to ensure proper communication between the NAS and the RADIUS server.
- Configure RADIUS server parameters after 802.1X authentication is enabled on the NAS.

| | |
|------------------------------|--|
| Command | radius-server host <i>ip-address</i> [auth-port <i>port1</i>] [acct-port <i>port2</i>] |
| Parameter Description | <i>ip-address</i> : Indicates the IP address of the RADIUS server. <i>port1</i> : Indicates the authentication port. <i>port2</i> : Indicates the accounting port. |
| Defaults | No RADIUS server parameters are configured by default. |
| Command Mode | Global configuration mode |
| Usage Guide | N/A |

↘ Configuring the Preshared Key for Communication between the NAS and RADIUS Server

- (Mandatory) The preshared key for communication between the NAS and RADIUS server must be configured to ensure proper communication between the NAS and the RADIUS server.
- Configure the preshared key of the RADIUS server after 802.1X authentication is enabled on the NAS.

| | |
|------------------------------|--|
| Command | radius-server key <i>string</i> |
| Parameter Description | <i>string</i> : Indicates the preshared key. |
| Defaults | No preshared key is configured for communication between the NAS and RADIUS server by default. |
| Command Mode | Global configuration mode |
| Usage Guide | The IP address of the NAS must be the same as that registered on the RADIUS server. The preshared key on the NAS must be the same as that on the RADIUS server. If the default RADIUS communication ports are changed on the RADIUS server, you need to change the communication ports on the NAS correspondingly. |

↘ Enabling 802.1X on a Port

- This command is mandatory for a wired network.
- Enable 802.1X on switches.

| | |
|------------------------------|---|
| Command | dot1x port-control auto |
| Parameter Description | N/A |
| Defaults | 802.1X is disabled on a port by default. |
| Command Mode | Interface configuration mode, VxLAN mode |
| Usage Guide | 802.1X is disabled on a port by default. This command is mandatory for the deployment of 802.1X authentication. The default method list is used by default. If the 802.1X authentication method list in AAA is not the default one, the configured 802.1X authentication method list should match. |

↘ Enabling 802.1X

- This function is mandatory in a wireless network.
- Enable 802.1X on an AC or AP.
- If 802.1X is enabled on a WLAN, only 802.11 management frames and EAP packets are allowed to pass.
- For related commands, see the *Configuring RSNA*.

Verification

Start Ruijie Supplicant, enter the correct account information, and initiate authentication. Then check whether the 802.1X and RADIUS configurations are correct.

↘ Checking for 802.1X Authentication Entries

| | |
|------------------------------|---|
| Command | show dot1x summary |
| Parameter Description | N/A |
| Command Mode | Privileged EXEC mode/Global configuration mode/Interface configuration mode |
| Usage Guide | Display entries of authenticated users to check the authentication status of users, for example, authenticating, authenticated, or quiet. |
| Command Display | <pre>Ruijie#show dot1x summary ID Username MAC Interface VLAN Auth-State Backend-state Port-Status User-Type Time ----- ----- 16777302 ts-user b048.7a7f.f9f3 wlan 1 1 Authenticated Idle Authed static 0days 0h 0m12s</pre> |

↘ Checking for AAA User Entries

| | |
|------------------------------|--|
| Command | show aaa user all |
| Parameter Description | N/A |
| Command Mode | Privileged EXEC mode/Global configuration mode/Interface configuration mode |
| Usage Guide | Display information of AAA users. |
| Command Display | <pre>Ruijie#show aaa user all ----- Id ----- Name 2345687901 wwxy -----</pre> |

- Check whether the RADIUS server responds to authentication based on the RADIUS packets between the NAS and the RADIUS server. If no, it means that the network is disconnected or parameter configurations are incorrect. If the RADIUS server directly returns a rejection reply, check the log file on the RADIUS server to identify the cause, e.g., of the authentication mode of the authentication server is incorrectly configured.

Configuration Example

↘ Configuring 802.1X Authentication on a WLAN

| | |
|---|---|
| <p>Scenario</p> <p>Figure 4-5</p> | |
| <p>Configuration Steps</p> | <ul style="list-style-type: none"> ● Register the IP address of the NAS on the RADIUS server and configure the communication key between the NAS and the RADIUS server. ● Create an account on the RADIUS server. ● Enable AAA on the NAS. ● Configure RADIUS parameters on the NAS. ● Enable 802.1X authentication on ports of the NAS. <p>NAS configurations are as follows. For detailed configuration on the RADIUS server, see the <i>Configuring RADIUS</i>.</p> |
| | <pre>ruijie# configure terminal ruijie (config)# aaa new-model ruijie (config)# radius-server host 192.168.32.120 ruijie (config)# radius-server key ruijie ruijie (config)# wlansec 1 Ruijie(config-wlansec)# security rsn enable Ruijie(config-wlansec)# security rsn ciphers aes enable Ruijie(config-wlansec)# security rsn akm 802.1x enable</pre> |
| <p>Verification</p> | <p>Check whether authentication is proper and network access behaviors change after authentication.</p> <ul style="list-style-type: none"> ● The account is successfully created, such as username:tests-user,password:test. ● The user fails to ping 192.168.32.120 before authentication. ● After the user enters account information and click Authenticate on Ruijie Supplicant, the authentication succeeds and the user can successfully ping 192.168.32.120. ● Information of the authenticated user is displayed. <pre>ruijie# show dot1x summary ID Username MAC Interface VLAN Auth-State Backend-State Port-Status User-Type Time</pre> |

| | | | | | | |
|----------|---------|----------------|--------|---|---------------|------|
| ----- | | | | | | |
| ----- | | | | | | |
| 16778217 | ts-user | 0023.aaaa.4286 | wlan 1 | 2 | Authenticated | Idle |
| Authed | static | 0days 0h 0m 7s | | | | |

Common Errors

- RADIUS parameters are incorrectly configured.
- The RADIUS server has a special access policy, for example, the RADIUS packets must carry certain attributes.
- The AAA authentication mode list is different from the 802.1X authentication mode list, causing authentication failure.

4.4.2 Configuring 802.1X Parameters

Configuration Effect

- Adjust 802.1X parameter configurations based on the actual network situation. For example, if the authentication server has poor performance, you can raise the authentication server timeout.

Notes

- 802.1X and RADIUS have separate server timeouts. By default, the authentication server timeout of 802.1X is 5 seconds while that of RADIUS is 15 seconds. In actual situations, ensure that the former is greater than the latter. You can run the **dot1x timeout server-timeout** command to adjust the authentication server timeout of 802.1X. For detailed configuration about the RADIUS server timeout, see the *Configuring RADIUS*.

Configuration Steps

▾ Enabling Re-authentication

- (Optional) After re-authentication is enabled, the NAS can periodically re-authenticate online users.
- Enable re-authentication after 802.1X authentication is enabled on the NAS.

| | |
|---------------------|---|
| Command | dot1x re-authentication |
| Parameter | N/A |
| Description | |
| Defaults | Re-authentication is disabled by default. |
| Command Mode | Global configuration mode |
| Usage Guide | You can run this command to periodically re-authenticate users. |

▾ Configuring the Re-authentication Interval

- (Optional) You can configure the re-authentication interval for users.
- Configure the re-authentication interval after 802.1X authentication is enabled on the NAS. The re-authentication interval takes effect only after re-authentication is enabled.

| | |
|------------------------------|--|
| Command | dot1x timeout re-authperiod <i>period</i> |
| Parameter Description | <i>period</i> : Indicates the re-authentication interval in the unit of seconds. |
| Defaults | The default value is 3,600 seconds. |
| Command Mode | Global configuration mode |
| Usage Guide | Adjust the re-authentication interval as required. |

↘ Configuring the Interval of EAP-Request/Identity Packet Retransmission

- (Optional) A larger value indicates a longer interval of packet retransmission.
- Configure the interval of EAP-Request/Identity packet retransmission after 802.1X authentication is enabled on the NAS.

| | |
|------------------------------|--|
| Command | dot1x timeout tx-period <i>period</i> |
| Parameter Description | <i>period</i> : Indicates the interval of EAP-Request/Identity packet retransmission in the unit of seconds. |
| Defaults | The default value is 3 seconds. |
| Command Mode | Global configuration mode |
| Usage Guide | It is recommended to use the default value. Adjust the value based on how long the authentication client responds to the NAS's requests. |

↘ Configuring the Maximum Times of EAP-Request/Identity Packet Retransmission

- (Optional) A larger value indicates more frequent retransmissions.
- Configure the maximum times of EAP-Request/Identity packet retransmission after 802.1X authentication is enabled on the NAS.

| | |
|------------------------------|--|
| Command | dot1x reauth-max <i>num</i> |
| Parameter Description | <i>num</i> : Indicates the maximum times of EAP-Request/Identity packet retransmission. |
| Defaults | The default value is 3 for switches while 6 for wireless devices. |
| Command Mode | Global configuration mode |
| Usage Guide | It is recommended to use the default value. In the case of high-rate packet loss, increase this value so that the clients can easily receive packets from the NAS. |

↘ Configuring the Interval of EAP-Request/Challenge Packet Retransmission

- (Optional) A larger value indicates a longer retransmission interval.
- Configure the interval of EAP-Request/Challenge packet retransmission after 802.1X authentication is enabled on the NAS.

| | |
|----------------|---|
| Command | dot1x timeout supp-timeout <i>time</i> |
|----------------|---|

| | |
|------------------------------|---|
| Parameter Description | <i>time</i> : Indicates the interval of EAP-Request/Challenge packet transmission in the unit of seconds. |
| Defaults | The default value is 3 seconds for switches while 4 seconds for wireless devices. |
| Command Mode | Global configuration mode |
| Usage Guide | It is recommended to use the default value. Increase this value in the case of high-rate packet loss. |

▾ Configuring the Maximum Times of EAP-Request/Challenge Packet Retransmission

- (Optional) A larger value indicates more frequent retransmissions.
- Configure the maximum times of EAP-Request/Challenge packet retransmission after 802.1X authentication is enabled on the NAS.

| | |
|------------------------------|--|
| Command | dot1x max-req <i>num</i> |
| Parameter Description | <i>num</i> : Indicates the maximum times of EAP-Request/Challenge packet retransmission in the unit of seconds. |
| Defaults | The default value is 3. |
| Command Mode | Global configuration mode |
| Usage Guide | Optional. It is recommended to use the default value. Increase this value in the case of high-rate packet loss. |

▾ Configuring the Authentication Server Timeout

- (Optional) A larger value indicates a longer authentication server timeout.
- Configure the authentication server timeout after 802.1X authentication is enabled on the NAS.
- The server timeout of RADIUS must be greater than that of 802.1X.

| | |
|------------------------------|---|
| Command | dot1x timeout server-timeout <i>time</i> |
| Parameter Description | <i>time</i> : Indicates the authentication server timeout in the unit of seconds. |
| Defaults | The default value is 5 seconds. |
| Command Mode | Global configuration mode |
| Usage Guide | It is recommended to use the default value. Increase this value if the communication between the NAS and RADIUS server is unstable. |

▾ Configuring the Quiet Period after Authentication Fails

- (Optional) A larger value indicates a longer quiet period.
- Configure the quiet period after 802.1X authentication is enabled on the NAS.

| | |
|------------------|--|
| Command | dot1x timeout quiet-period <i>time</i> |
| Parameter | <i>time</i> : Indicates the quiet period after authentication fails. The unit is second. |

| | |
|---------------------|--|
| Description | |
| Defaults | The default value is 10 seconds. |
| Command Mode | Global configuration mode |
| Usage Guide | It is recommended to use the default value. Increase this value to prevent users from frequently initiating authentication to the RADIUS server, thereby reducing the load of the authentication server. |

📌 **Specifying the Authentication Mode**

- (Optional) Configure the mode for 802.1X authentication.
- Configure the authentication mode after 802.1X authentication is enabled on the NAS.

| | |
|------------------------------|---|
| Command | dot1x auth-mode {eap chap pap} |
| Parameter Description | eap: Indicates EAP authentication. chap: Indicates CHAP authentication. pap: Indicates PAP authentication. |
| Defaults | The default value is eap . |
| Command Mode | Global configuration mode |
| Usage Guide | Select the authentication mode supported by Ruijie Supplicant and authentication server. |

Verification

Run the **show dot1x** command to check whether parameter configurations take effect.

Configuration Example

📌 **Specifying the Authentication Mode**

| | |
|----------------------------|---|
| Scenario | The NAS is deployed in standalone mode. |
| Configuration Steps | Set the authentication mode to chap . <pre>Ruijie(config)#dot1x auth-mode chap</pre> |
| Verification | Display the configurations. <pre>Ruijie(config)#show dot1x</pre> <pre>802.1X basic information: 802.1X Status enable Authentication Mode chap Authorization mode disable Total User Number 0 (exclude dynamic user) Authenticated User Number 0 (exclude dynamic user) Dynamic User Number 0</pre> |

| | |
|--------------------------------|--------------|
| Re-authentication | disable |
| Re-authentication Period | 3600 seconds |
| Re-authentication max | 3 times |
| Quiet Period | 10 seconds |
| Tx Period | 30 seconds |
| Supplicant Timeout | 3 seconds |
| Server Timeout | 5 seconds |
| Maximum Request | 3 times |
| Client Online Probe | disable |
| Eapol Tag | disable |
| 802.1x redirect | disable |
| Private supplicant only | disable |

Common Errors

- The server timeout is shorter than the RADIUS timeout.

4.4.3 Configuring MAB

Configuration Effect

- On WLANs, WLAN-based MAB is supported. If MAB is enabled, the NAS automatically associates the MAC address of an STA on the WLAN as the user name and password to initiate authentication to the authentication server.

Notes

- If MAB is enabled on a WLAN, set the WLAN security mode to OPEN.

Configuration Steps

▾ Enabling WLAN-based MAB

- Optional.
- Enable MAB on the WLAN connected to STAs.

| | |
|---------------------|--|
| Command | dot1x-mab |
| Parameter | N/A |
| Description | |
| Defaults | WLAN-based MAB is disabled by default. |
| Command Mode | WLAN security configuration mode |
| Usage Guide | Run this command when STAs on a WLAN need to perform authentication using MAC addresses. This command applies only to wireless devices. |

➤ **Enabling Uppercase Letters in MAB User Names**

- Optional.
- Enable this function in global configuration mode.

| | |
|------------------------------|--|
| Command | dot1x mab-username upper |
| Parameter Description | N/A |
| Defaults | This function is disabled by default. |
| Command Mode | Global configuration mode |
| Usage Guide | By default, lowercase letters are used in the user name of MAB. After this function is enabled, uppercase letters are used in new user names of MAB to meet server requirements. |

Verification

Check whether the dumb user can access the network. If yes, MAB takes effect. If no, MAB does not take effect.

- Check whether MAB functions are configured on the authentication server and NAS.
- Check whether dumb users with illegitimate MAC addresses cannot access the network.
- Check whether dumb users with illegitimate MAC addresses can access the network.

Configuration Example

➤ **Enabling WLAN-based MAB**

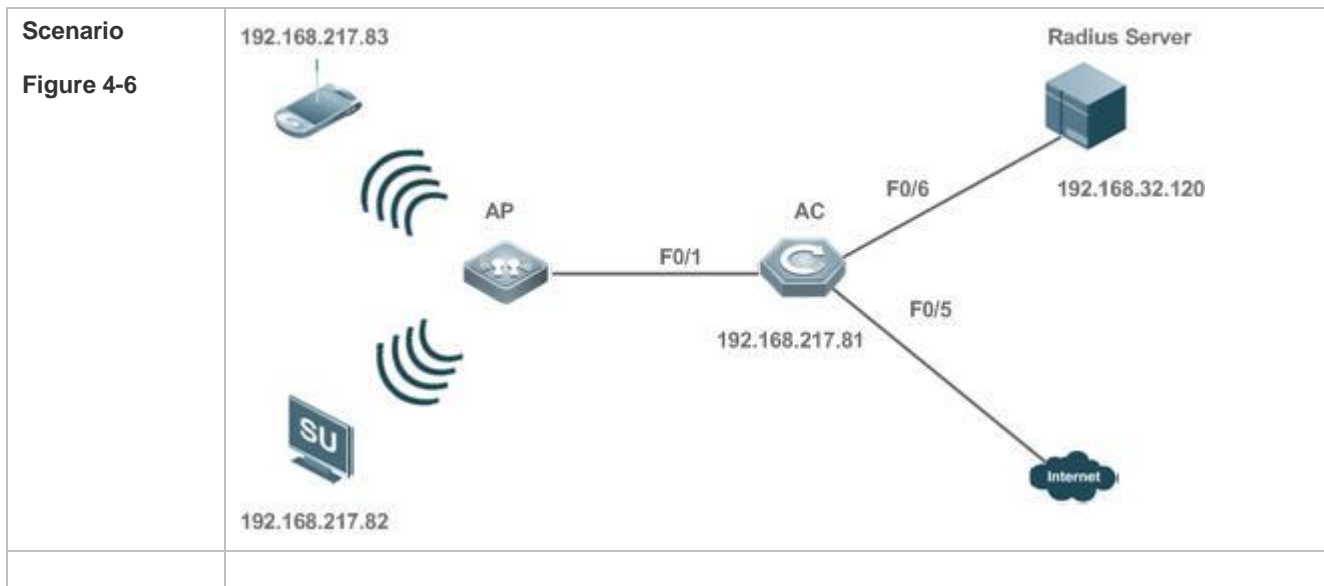

| | |
|----------------------------|---|
| Configuration Steps | <ul style="list-style-type: none"> ● Register the IP address of the NAS on the RADIUS server and configure the communication key between the NAS and the RADIUS server. ● Create an account on the RADIUS server. ● Enable AAA on the NAS. ● Configure RADIUS parameters on the NAS. ● Enable WLAN-based MAB on the NAS. <p>NAS configurations are as follows. For detailed configuration on the RADIUS server, see the <i>Configuring RADIUS</i>.</p> |
| | <pre>ruijie# configure terminal ruijie (config)# aaa new-model ruijie (config)# radius-server host 192.168.32.120 ruijie (config)# radius-server key ruijie ruijie (config)# wlansec 1 ruijie (config-wlansec)# dot1x-mab</pre> |
| Verification | <p>Check whether authentication is proper and network access behaviors change after authentication.</p> <ul style="list-style-type: none"> ● The account is successfully created, such as username: 0023aeaa4286,password: 0023aeaa4286. ● The STA fails to ping 192.168.32.120 before authentication. ● The STA connects to the NAS, the authentication succeeds, and the STA can successfully ping 192.168.32.120. ● Information of the authenticated user is displayed. <pre>ruijie# show dot1x summary ID Username MAC Interface VLAN Auth-State Backend-State Port-Status User-Type Time ----- ----- 16778217 0023aea... 0023.aeaa.4286 Fa0/1 2 Authenticated Idle Authed static 0days 0h 5m 8s</pre> |

Common Errors

- The MAC account format is incorrect on the authentication server.

4.4.4 Configuring MAB Auto Authentication

Configuration Effect

- When a STA accesses the network for the first time, Web authentication is performed. When the STA is disconnected from and then reconnects to the network, authentication is not required.

Notes

- Wireless MAB authentication is triggered by a STA advertisement. If a STA is already online, MAB authentication will not be triggered again. MAB authentication is triggered only after the STA is disconnected from and then reconnects to the network.
- When a STA accesses the network for the second time, a dialog box may be displayed for MAB authentication. When the STA accesses the network for the third time, the dialog box will not be displayed.
- If MAB authentication fails, a dialog box is displayed for Web authentication when the STA accesses the network next time.

Configuration Steps

For details about Web authentication configuration, see the Web authentication configuration document. For details about MAB authentication configuration, see section 4.4.3 "Configuring MAB."

Configuration Example

▾ **Configuring MAB Auto Authentication**

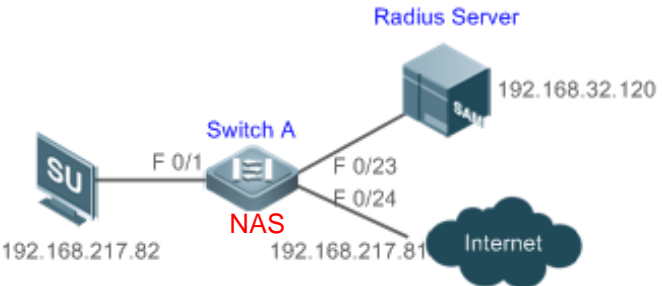
| | |
|---------------------------------------|--|
| <p>Scenario Figure 4-7</p> |  |
| <p>Configuration Steps</p> | <ul style="list-style-type: none"> ● Register the IP address of the NAS on the RADIUS server and configure the communication key between the NAS and the RADIUS server. ● Create an account on the RADIUS server and bind it with a MAC address for imperceptible authentication. ● Enable AAA on the NAS. ● Configure RADIUS parameters on the NAS. ● Enable 802.1X authentication and MAB authentication on an interface of the NAS. ● Enable second-generation (or first-generation/embedded) Web authentication on an interface of the NAS and configure the Web authentication template globally. <p>The following describes the NAS configurations. For detailed configuration on the RADIUS server, see the related configuration guide (The following describes configuration on the switch, which is similar to that on the AC/AP, except that the configuration on the switch is performed in interface configuration mode instead of WLAN RSNA configuration mode.)</p> |
| | <pre>ruijie#configure terminal ruijie (config)#aaa new-model</pre> |

```

ruijie (config)#aaa authentication web-auth default group radius
ruijie (config)#aaa authentication dot1x default group radius
ruijie (config)#aaa accounting net-work default start-stop group radius
ruijie (config)#radius-server host 192.168.32.120
ruijie (config)#radius-server key ruijie
ruijie (config)#web-auth template eportalv2
ruijie (config-tmpl-v2)#ip 192.158.32.9
ruijie (config-tmpl-v2)#url http://192.168.32.9:8080/eportal/index.jsp
ruijie (config-tmpl-v2)#exit
ruijie (config)#interface FastEthernet 0/1
ruijie (config-if)#dot1x port-control auto
ruijie (config-if)#dot1x mac-auth-bypass multi-user
ruijie (config-if)#web-auth enable eportalv2

```

Verification

Check whether authentication is normal and network access behaviors change after authentication.

- The account is successfully created, for example, the username is 0023aeaa4286 and the password is 0023aeaa4286.
- The STA fails to ping 192.168.32.120 before authentication.
- The STA connects to the NAS, a page indicating the authentication succeeds is displayed, and the STA can successfully ping 192.168.32.120.
- The STA is disconnected from and then reconnects to the network and can successfully ping 192.168.32.120.

```

ruijie#show dot1x summary
ID          Username      MAC          Interface  VLAN  Auth-State
Backend-State Port-Status  User-Type   Time
-----
-----
16778217   0023aea...   0023.aeaa.4286  Fa0/1     2     Authenticated  Idle
Authed     static      0days 0h 5m 8s

```

Common Errors

- The MAC account format is incorrect on the authentication server.

4.4.5 Configuring Extended Functions**Configuration Effect**

- The multi-account function allows a user to switch its account upon re-authentication. In special scenarios such as Windows domain authentication, multiple authentications are required to access the domain and the user account changes during authentication. This function applies to these scenarios.
- 802.1X allows users to obtain IP addresses before accounting. In this manner, the IP address is carried during user accounting, meeting service requirements. After a user is authenticated and goes online, the NAS can obtain the IP

address of the user from the supplicant or through DHCP snooping, and then 802.1X server initiates an accounting request. To avoid the case in which the NAS does not initiate accounting for a long time due to failure to obtain the IP address of the authentication client, configure the IP detection timeout for this function. If the NAS does not obtain the IP address of the user within the configured time (5 minutes by default), it forces the user offline.

- 802.1X allows users to switch to the preset bypass WLAN when the RADIUS server is inaccessible. Survival WLANs are generally in OPEN mode and their services are unavailable by default. If 802.1X-based WLAN services are unavailable, enable this WLAN and disable WLAN-based 802.1X authentication so that users can switch to the bypass WLAN to properly access the network.
- 802.1X can be used with Web authentication. If Web authentication is enabled on an 802.1X-enabled WLAN, users perform 802.1X authentication only for encryption purposes. To access the network, they should also perform Web authentication. In this case, all air interface data of users is encrypted, enhancing security of user data.
- 802.1X provides prompts on syslog printing of user online/offline. You can adjust the online/offline syslog printing rate based on the user authentication rate to prevent high CPU utilization due to frequent syslog printing for a large number of users going online/offline.
- In the WLAN-based 802.1X authentication scenario, the NAS sends the authentication server SNMP traps to notify the online/offline status of users.
- In the WLAN-based 802.1X authentication scenario, traffic monitoring can be enabled on a WLAN. That is, if the traffic of an authenticated user is lower than the configured threshold within the specified period, the user will be forced offline so that the authentication server can perform accounting in a timely manner.
- Some servers deliver the accounting update interval only upon users' first authentication attempts. After re-authentication, users still use the accounting update interval configured on the NAS instead of that configured on the authentication server. To ensure the NAS to send accounting update packets according to the accounting update interval configured on the authentication server, you can configure users to always follow the accounting update interval assigned by the authentication server upon the first authentication.
- Based on a real scenario, H3C devices are deployed and the MAB authentication server configures the user name in xx-xx-xx-xx-xx-xx format. However, the default MAB authentication user name format of Ruijie devices is xxxxxxxxxxxx. Therefore, a command needs to be added to control the user name format.
- Based on a real scenario, wireless terminals use static IP addresses and need to report the IP addresses to the server. In 802.1X authentication mode, the default IP address source is obtained by running the **ip dhcp snooping** command. **stamg** needs to be added to advertise the static IP address source.

Notes

- The multi-account function must be disabled if accounting is enabled. Otherwise, accounting may be inaccurate.
- IP-based accounting is not required in two situations:
 - IPv4 addresses and Ruijie Supplicant are deployed. This function is not required because Ruijie Supplicant can upload the IPv4 addresses of users.
 - Static IP addresses are deployed.

- It is recommended that the SSID of the bypass WLAN be different from that of the 802.1X-based WLAN so that the bypass WLAN services can be intuitively reflected. Moreover, when the WLAN needs to be switched due to server inaccessibility, users can manually switch the SSID once. Since the supplicant generally has a memory of the SSID, the SSID can be switched automatically in the future.
- Since 802.1X users are only for encryption purposes, the authorization, e.g., ACL assignment and rate limit assignment, to 802.1X users will not take effect. However, users need to pass Web authentication and be authorized to access the network.

Configuration Steps

▾ Enabling Multi-account Authentication with One MAC Address

- (Optional) Run the **dot1x multi-account enable** command to allow the same MAC address to be used by multiple accounts.
- Enable multi-account authentication with one MAC address after 802.1X authentication is enabled on the NAS.

| | |
|------------------------------|--|
| Command | dot1x multi-account enable |
| Parameter Description | N/A |
| Defaults | Multi-account authentication is disabled by default. |
| Command Mode | Global configuration mode |
| Usage Guide | Configure this command when multi-account authentication is required in 802.1X authentication, e.g. in the case of Windows domain authentication. In this case, the authentication client can directly use a new account to initiate authentication while the previous account is still online. Multi-account authentication is disabled by default. |

▾ Configuring the Maximum Number of Authenticated Users on a Port

- (Optional) You can restrict the number of online users on a controlled port, including static users and dynamic users.
- Configure the maximum number of authenticated users on a port after 802.1X authentication is enabled on the NAS.

| | |
|------------------------------|--|
| Command | dot1x default-user-limit <i>num</i> |
| Parameter Description | <i>num</i> : Indicates the maximum number of online users. |
| Defaults | There is no restriction on the number of users on a port by default. |
| Command Mode | Interface configuration mode, VxLAN mode |
| Usage Guide | Configure this command when there is a need to restrict the number of authenticated users on a port. |

▾ Enabling IP-triggered Accounting

- (Optional) If IP-triggered accounting is enabled, the NAS sends an accounting request to the authentication server after obtaining the IP address of the user.
- Enable IP-triggered accounting after 802.1X authentication is enabled on the NAS.

| | |
|---------------------|---|
| Command | dot1x valid-ip-acct enable |
| Parameter | N/A |
| Description | |
| Defaults | IP-triggered accounting is disabled by default. |
| Command Mode | Global configuration mode |
| Usage Guide | If both accounting and IP-triggered accounting are enabled, the NAS initiates accounting only after obtaining the IP address of the authentication client, and forces the user offline if it fails to obtain the IP address. If accounting is disabled but IP-triggered accounting is enabled, the NAS does not initiate accounting after obtaining the IP address of the authentication client, and forces the user offline if it fails to obtain the IP address within the timeout. |

✚ Configuring the Timeout of Obtaining IP Addresses After Authentication

- (Optional) Configure the timeout of obtaining IP addresses if IP-triggered accounting is enabled.
- Configure the IP address obtaining timeout after 802.1X authentication is enabled on the NAS.

| | |
|------------------------------|---|
| Command | dot1x valid-ip-acct timeout <i>time</i> |
| Parameter Description | <i>time</i> : Indicates the timeout in the unit of minutes. |
| Defaults | The default value is 5 minutes. |
| Command Mode | Global configuration mode |
| Usage Guide | It is recommended to use the default value. Configure this command when there is a need to change the IP address obtaining timeout after users pass authentication. |

✚ Configuring the Bypass WLAN for the RADIUS Server

- Optional.
- Enable bypass WLAN for the RADIUS server after 802.1X authentication is enabled on the NAS.

| | |
|------------------------------|--|
| Command | dot1x event server-invalid action bypass-wlan <i>wlan_id</i> |
| Parameter Description | <i>wlan_id</i> : Indicates the bypass WLAN. |
| Defaults | Bypass WLAN is disabled by default. |
| Command Mode | Global configuration mode |
| Usage Guide | This command applies only to wireless devices. It is recommended to use the default value. Configure this command when there is a need to provide the corresponding WLAN in the case of server inaccessibility. |

✚ Configuring 802.1X Authentication for Encryption Only When 802.1X and Web Authentication Are Both Enabled

- (Optional) If 802.1X and Web authentication is enabled meanwhile, 802.1X is used only for encryption.

- Enable this function after 802.1X authentication is enabled on the NAS.

| | |
|------------------------------|--|
| Command | dot1x encryption only |
| Parameter Description | N/A |
| Defaults | This function is disabled by default. |
| Command Mode | WLAN security configuration mode |
| Usage Guide | It is recommended to retain the default setting. This command applies only to wireless devices. |

↘ Limiting the Rate of Printing Online and Offline Logs

- (Optional) You can limit the syslog printing rate upon 802.1X users going online/offline.
- Enable the syslog printing rate limit after 802.1X authentication is enabled on the NAS.

| | |
|------------------------------|---|
| Command | dot1x logging rate-limit <i>value</i> |
| Parameter Description | <i>value</i> : Indicates the syslog printing rate per second upon users going online/offline. The default value is 5 per second. 0 indicates no rate limit. |
| Defaults | The default value is 5 per second. |
| Command Mode | Global configuration mode |
| Usage Guide | Generally it is recommended to use the defaults. If a large number of users frequently go online/offline, reduce this rate. This command applies only to wireless devices. |

↘ Enabling SNMP Trap During Online and Offline

- (Optional) The **dot1x user-trap enable** command is used to control whether to send traps to the SNMP server when 802.1X users go online or offline.
- Enable SNMP trap after 802.1X authentication is enabled on the NAS.

| | |
|------------------------------|--|
| Command | dot1x user-trap enable |
| Parameter Description | N/A |
| Defaults | SNMP trap is disabled by default. |
| Command Mode | Global configuration mode |
| Usage Guide | This command applies only to wireless 802.1X authentication devices. Configure this command when the NAS should send online/offline traps to the SNMP server. You also need to enable trap on the SNMP server. For details, see the <i>Configuring SNMP</i> . |

↘ Enabling Traffic Detection

- (Optional) If traffic detection is enabled, 802.1X-authenticated users with traffic lower than the threshold in the detection period will be kicked off to avoid incorrect accounting.
- Enable traffic detection after 802.1X authentication is enabled on the NAS.

| | |
|---------------------|--|
| Command | dot1x offline-detect {[interval <i>va</i>] [flow <i>num</i>]} |
| Parameter | <i>va</i> : Indicates the detection period. The default value is 8 hours. |
| Description | <i>num</i> : Indicates the traffic threshold. The default value is 0 KB. |
| Defaults | By default, traffic detection is enabled on the AC but disabled on the APs. |
| Command Mode | WLAN security configuration mode |
| Usage Guide | This command applies only to wireless 802.1X authentication devices. Configure this command when the NAS needs to detect STAs offline in a timely manner to prevent incorrect accounting. |

✚ Using the Accounting Update Interval Delivered by the Server Upon the First Authentication

- (Optional) If this function is enabled, online users always use the accounting update interval assigned by the authentication server upon the first authentication, instead of the accounting update interval configured on the NAS.

| | |
|---------------------|--|
| Command | dot1x acct-update base-on first-time server |
| Parameter | N/A |
| Description | |
| Defaults | This function is disabled by default. |
| Command Mode | Global configuration mode |
| Usage Guide | Configure this command when the authentication server does not deliver the accounting update interval upon user re-authentication but the NAS must send accounting update packets according to the accounting update interval assigned by the authentication server upon the first authentication. |

✚ Configuring the Format of MAB Authentication Username

- (Optional) This function works only to MAB authentication users.

| | |
|---------------------|--|
| Command | dot1x mab-username format with-dot with-colon with-hyphen |
| Parameter | N/A |
| Description | |
| Defaults | This function is disabled by default. |
| Command Mode | Global configuration mode |
| Usage Guide | The dot1x mab-username format with-dot command specifies the format of "xxxx.xxxx.xxxx". The dot1x mab-username format with-colon command specifies the format of "xx:xx:xx:xx:xx:xx". The dot1x mab-username format with-hyphen command specifies the format of "xx-xx-xx-xx-xx-xx". |

✚ Obtains Static IP Addresses

- (Optional) This function works to both 802.1X and MAB authentication users.

| | |
|---------------------|--|
| Command | dot1x get-static-ip enable |
| Parameter | N/A |
| Description | |
| Defaults | This function is disabled by default. |
| Command Mode | Global configuration mode |
| Usage Guide | <p>Enable this function when an STAtic IP address applied on a wireless device needs to be uploaded to the server.</p> <p> The static IP address is uploaded to the server via an accounting packet. And no terminal ID is contained when an STAtic IP address is used.</p> |

4.5 Monitoring

Clearing

 Authentication user information can be cleared after 802.1X is disabled.

| Description | Command |
|--|----------------------------------|
| Clears 802.1X user information. | no do1x port-control auto |
| Clears 802.1X user information. | clear dot1x user |
| Restores the default 802.1X configuration. | dot1x default |

Notes

- The **dot1x default** command is used to restore global configurations.

| Description | Command |
|---|---|
| Restore default values of configurations related to re-authentication. | dot1x re-authentication dot1x timeout re-authperiod dot1x reauth-max |
| Restores the default value of the number of retransmission times. | dot1x mac-req |
| Restores the default value of the authentication mode. | dot1x auth-mode |
| Restore the default values of functions related to accounting after obtaining the IP address. | dot1x valid-ip-acct enable dot1x valid-ip-acct timeout |

Displaying

| Description | Command |
|-------------|---------|
|-------------|---------|

| | |
|--|--|
| Displays the parameters and status of the RADIUS server. | show radius server |
| Displays 802.1X status and parameters. | show dot1x |
| Displays the active authentication status. | show dot1x auto-req |
| Displays the port control status. | show dot1x port-control |
| Displays the status and parameters of host probe. | show dot1x probe-timer |
| Displays of the information of authenticated users. | show dot1x summary |
| Displays the maximum times of EAP-Request/Challenge packet retransmission. | show dot1x max-req |
| Displays the information of controlled ports. | show dot1x port-control |
| Displays the re-authentication status. | show dot1x re-authentication |
| Displays the maximum times of EAP-Request/Identity packet retransmission. | show dot1x reauth-max |
| Displays the quiet period after authentication fails. | show dot1x timeout quiet-period |
| Displays the re-authentication interval. | show dot1x timeout re-authperiod |
| Displays the authentication server timeout. | show dot1x timeout server-timeout |
| Displays the supplicant timeout. | show dot1x timeout supptimeout |
| Displays the interval of EAP-Request/Identity packet retransmission. | show dot1x timeout tx-period |
| Displays user information based on the user ID. | show dot1x user id |
| Displays user information based on the MAC address. | show dot1x user mac |
| Displays user information based on the user name. | show dot1x user name |

Debugging

 System resources are occupied when debugging information is output. Therefore, disable the debugging switch immediately after use.

| Description | Command |
|---|---------------------------|
| Debugs AAA. (For details, see the <i>Configuring AAA</i> .) | debug aaa |
| Debugs RADIUS. (For details, see the <i>Configuring RADIUS</i> .) | debug radius |
| Debugs 802.1X events. | debug dot1x event |
| Debugs 802.1X packets. | debug dot1x packet |
| Debugs 802.1X state machine (STM). | debug dot1x stm |
| Debugs 802.1X internal communication. | debug dot1x com |
| Debugs 802.1X errors. | debug dot1x error |

5 Configuring ARP Check

5.1 Overview

The Address Resolution Protocol (ARP) packet check filters all ARP packets under ports (including wired layer-2 switching ports, layer-2 aggregate ports (APs), and layer-2 encapsulation sub-interfaces, as well as WLAN interfaces) and discards illegal ARP packets, so as to effectively prevent ARP deception via networks and to promote network stability. On devices supporting ARP check, illegal ARP packets in networks will be ignored according to the legal user information (IP-based or IP-MAC based) generated by security application modules such as IP Source Guard, global IP+MAC binding, 802.1X authentication, GSN binding, Web authentication and port security.

Figure 5-1

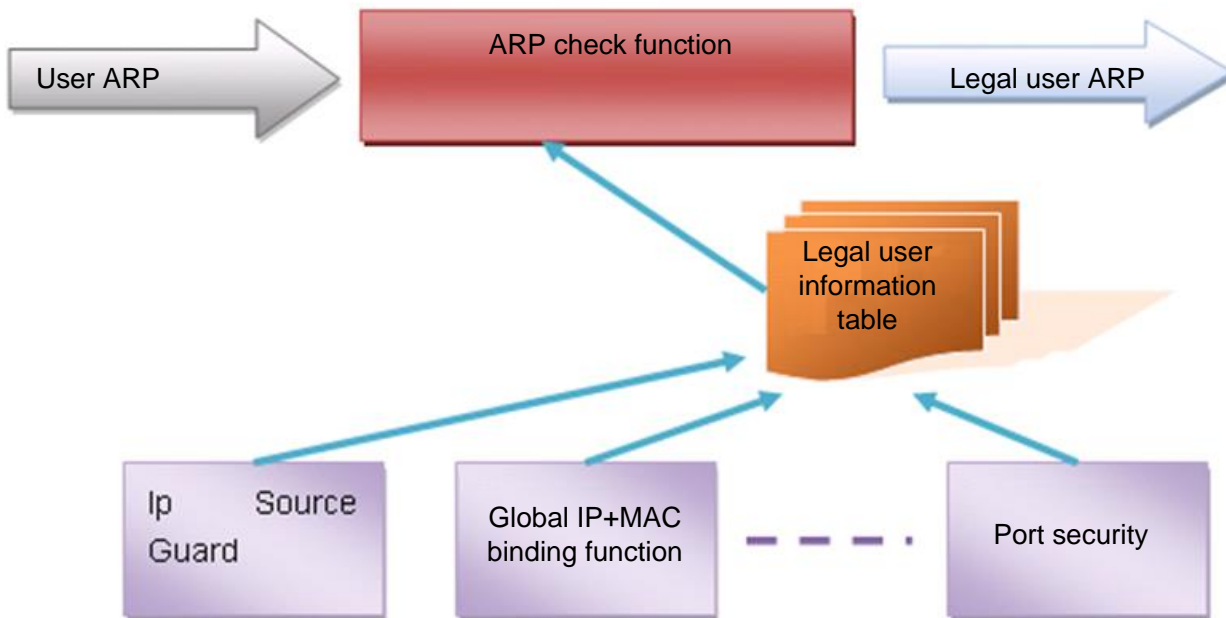

The above figure shows that security modules generate legal user information (IP-based or IP-MAC based). ARP Check uses the information to detect whether the Sender IP fields or the <Sender IP, Sender MAC>fields in all ARP packets at ports matches those in the list of legal user information. If not, all unlisted ARP packets will be discarded.

Protocols and Standards

- RFC826: An Ethernet Address Resolution Protocol or Converting Network Protocol Addresses

5.2 Applications

| Application | Description |
|---|--|
| Filtering ARP packets in Networks | Illegal users in networks launch attacks using forged ARP packets. |

5.2.1 Filtering ARP Packets in Networks

Scenario

Check ARP packets from distrusted ports and filter out ARP packets with addresses not matching the results assigned by the DHCP server.

For example, in the following figure, the ARP packets sent by DHCP clients are checked.

- The ports receiving ARP packets, the source MAC addresses of ARP packets, and the source IP addresses of ARP packets shall be consistent with the snooped DHCP-assigned records.

Figure 5-2

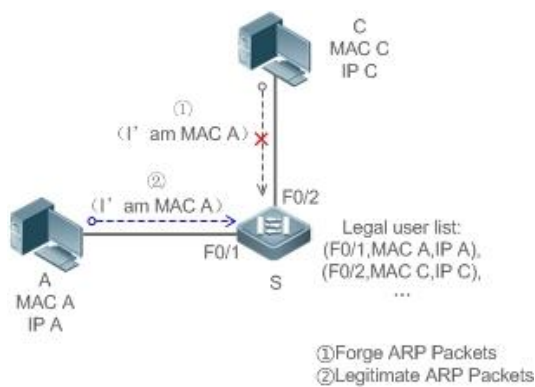

| | |
|-----------------|---|
| Remarks: | S is an access device. A and C are user PCs. |
|-----------------|---|

Deployment

- Enable DHCP Snooping on S to realize DHCP monitoring.
- Set all the downlink ports on S as DHCP distrusted ports.
- Enable IP Source Guard and ARP Check on all distrusted ports on S to realize ARP packet filtration.

5.3 Features

Basic Concepts

Compatible Security Modules

Presently, the ARP Check supports the following security modules.

- IP-based: IP-based mode: port security, and static configuration of IP Source Guard.
- IP-MAC based: IP-MAC based mode: port security, global IP+MAC binding, 802.1X authorization, IP Source Guard, GSN binding, and Web authentication.

📌 Two Modes of APR Check

The ARP Check has two modes: Enabled and Disabled. The default is Enabled.

1. Enabled Mode

Through ARP Check, ARP packets are detected based on the IP/IP-MAC based binding information provided by the following modules.

- Global IP-MAC binding
- 802.1X authorization
- IP Source Guard
- GSN binding
- Port security
- Web authentication
- Port security IP+MAC binding or IP binding

⚠️ When only ARP Check is enabled on a port but the above-mentioned modules are not enabled, legal user information cannot be generated, and thereby all ARP packets from this port will be discarded.

⚠️ When the ARP Check and VRRP functions are enabled on an interface, if the physical IP address and virtual IP address of the interface can be used as the gateway address, the physical IP address and VRRP IP address need to be permitted to pass. Otherwise, ARP packets sent to the gateway will be filtered out.

2. Disabled Mode

ARP packets on a port are not checked.

Overview

| Feature | Description |
|---------------------------------------|--|
| Filtering ARP Packets | Check the source IP and source MAC addresses of ARP packets to filter out illegal ARP packets. |

5.3.1 Filtering ARP Packets

Enable ARP Check on specified ports to realize filtration of illegal ARP packets.

Working Principle

A device matches the source IP and source MAC addresses of the ARP packets received at its ports with the legal user information of the device. With successful matching, packets will be transferred, or otherwise they will be discarded.

Related Configuration

↘ Enabling ARP Check on Ports

- By default, the ARP Check is disabled on ports.
- Use the **arp-check** command to enable ARP Check.
- Unless otherwise noted, this function is usually configured on the ports of access devices.

5.4 Configuration

| Configuration | Description and Command |
|---------------------------------------|---|
| Configuring ARP Check |  (Mandatory) It is used to enable APR Check. |
| | arp-check Enables ARP Check. |

5.4.1 Configuring ARP Check

Configuration Effect

- Illegal ARP packets are filtered out.

Notes

- When ARP Check is enabled, the number of policies or users of related security applications may decrease.
- ARP Check cannot be configured on mirrored destination ports.
- ARP Check cannot be configured on the trusted ports of DHCP Snooping.
- ARP Check cannot be configured on global IP+MAC exclude ports.
- ARP Check can be enabled only on wired switching ports, layer-2 APs, layer-2 encapsulation sub-interfaces, as well as WLAN interfaces. Enable ARP check for the wired in interface configuration mode, while for the wireless in WLAN security configuration mode.
- For fit APs in wired access mode, ARP Check needs to be enabled in ap-config all mode.

Configuration Steps

↘ Enabling ARP Check

- (Mandatory) The function is disabled by default. To use the ARP Check function, an administrator needs to run a command to enable it.

Verification

- Use the **show run** command to display the system configuration.
- Use the **show interfaces** { *interface-type interface-number* } **arp-check list** command to display filtering entries.

Related Commands

↳ Enabling ARP Check

| | |
|--------------------|---|
| Command | arp-check |
| Parameter | N/A |
| Description | |
| Command | Interface configuration mode, WLAN security configuration mode, or WLAN ap-config all configuration mode |
| Usage Guide | Generate ARP filtration information according to the legal user information of security application modules to filter out illegal ARP packets in networks. When the ARP Check function is enabled in WLAN ap-config all mode, the function is enabled on wired ports of all APs. |

Configuration Example

 The following configuration example introduces only ARP Check related configurations.

↳ Enabling ARP Check on ports

| | |
|----------------------------|---|
| Configuration Steps | <ul style="list-style-type: none"> ● Enable ARP Check. Restricted ARP packets must conform to entries of IP Source Guard, port security, or global IP+MAC binding. |
|----------------------------|---|

```
Ruijie# configure terminal
Ruijie(config)#address-bind 192.168.1.3 00D0.F800.0003
Ruijie(config)#address-bind install
Ruijie(config)#ip source binding 00D0.F800.0002 vlan 1 192.168.1.4 interface gigabitEthernet 0/1
Ruijie(config)# interface GigabitEthernet 0/1
Ruijie(config-if-GigabitEthernet 0/1)#arp-check
Ruijie(config-if-GigabitEthernet 0/1)#ip verify source port-security
Ruijie(config-if-GigabitEthernet 0/1)#switchport port-security
Ruijie(config-if-GigabitEthernet 0/1)#switchport port-security binding 00D0.F800.0001 vlan 1
192.168.1.1
Ruijie(config-if-GigabitEthernet 0/1)#exit
Ruijie(config)#interface gigabitEthernet 0/4
Ruijie(config-if-GigabitEthernet 0/4)#switchport port-security
Ruijie(config-if-GigabitEthernet 0/4)#switchport port-security binding 192.168.1.5
Ruijie(config-if-GigabitEthernet 0/4)#arp-check
Ruijie(config-if-GigabitEthernet 0/4)#exit
Ruijie(config)#interface gigabitEthernet 0/5
Ruijie(config-if-GigabitEthernet 0/5)#arp-check
Ruijie(config-if-GigabitEthernet 0/5)#end
Ruijie# configure terminal
Ruijie(config)#wlan-config 1 RUIJIE-SSID
Ruijie(config-wlan)#end
Ruijie#conf
Enter configuration commands, one per line. End with CNTL/Z.
Ruijie(config)#wlansec 1
Ruijie(config-wlansec)# ip verify source port-security
Ruijie(config-wlansec)#arp-check
Ruijie(config-wlansec)#end
Ruijie#conf
Enter configuration commands, one per line. End with CNTL/Z.
Ruijie(config)# ip source binding 0026.c79f.6e4c vlan 1 172.168.131.1 wlan 1
```

| Verification | Use the show interfaces arp-check list command to display the effective ARP Check list for interfaces. | | | | | | | | | | | | | | | | | | | | | | | | | | | | | | | | | | | | |
|---------------------|---|---------------|---------------|-----------|---------------|---------------------|----------------|-------------|--------------|---------------------|----------------|-------------|---------------|---------------------|----------------|-------------|---------------|---------------------|----------------|-------------|--------------|---------------------|--|-------------|---------------|---------------------|----------------|-------------|--------------|-----------|------------|-----------|---------------|--------|----------------|---------------|---------------|
| | <pre>Ruijie# show interfaces arp-check list</pre> <table border="1"> <thead> <tr> <th>INTERFACE</th> <th>SENDER MAC</th> <th>SENDER IP</th> <th>POLICY SOURCE</th> </tr> </thead> <tbody> <tr> <td>GigabitEthernet 0/1</td> <td>00d0.f800.0003</td> <td>192.168.1.3</td> <td>address-bind</td> </tr> <tr> <td>GigabitEthernet 0/1</td> <td>00d0.f800.0001</td> <td>192.168.1.1</td> <td>port-security</td> </tr> <tr> <td>GigabitEthernet 0/1</td> <td>00d0.f800.0002</td> <td>192.168.1.4</td> <td>DHCP snooping</td> </tr> <tr> <td>GigabitEthernet 0/4</td> <td>00d0.f800.0003</td> <td>192.168.1.3</td> <td>address-bind</td> </tr> <tr> <td>GigabitEthernet 0/4</td> <td></td> <td>192.168.1.5</td> <td>port-security</td> </tr> <tr> <td>GigabitEthernet 0/5</td> <td>00d0.f800.0003</td> <td>192.168.1.3</td> <td>address-bind</td> </tr> </tbody> </table> <pre>Ruijie# show wlan arp-check list</pre> <table border="1"> <thead> <tr> <th>INTERFACE</th> <th>SENDER MAC</th> <th>SENDER IP</th> <th>POLICY SOURCE</th> </tr> </thead> <tbody> <tr> <td>Wlan 1</td> <td>0026.c79f.6e4c</td> <td>172.168.131.1</td> <td>DHCP snooping</td> </tr> </tbody> </table> | INTERFACE | SENDER MAC | SENDER IP | POLICY SOURCE | GigabitEthernet 0/1 | 00d0.f800.0003 | 192.168.1.3 | address-bind | GigabitEthernet 0/1 | 00d0.f800.0001 | 192.168.1.1 | port-security | GigabitEthernet 0/1 | 00d0.f800.0002 | 192.168.1.4 | DHCP snooping | GigabitEthernet 0/4 | 00d0.f800.0003 | 192.168.1.3 | address-bind | GigabitEthernet 0/4 | | 192.168.1.5 | port-security | GigabitEthernet 0/5 | 00d0.f800.0003 | 192.168.1.3 | address-bind | INTERFACE | SENDER MAC | SENDER IP | POLICY SOURCE | Wlan 1 | 0026.c79f.6e4c | 172.168.131.1 | DHCP snooping |
| INTERFACE | SENDER MAC | SENDER IP | POLICY SOURCE | | | | | | | | | | | | | | | | | | | | | | | | | | | | | | | | | | |
| GigabitEthernet 0/1 | 00d0.f800.0003 | 192.168.1.3 | address-bind | | | | | | | | | | | | | | | | | | | | | | | | | | | | | | | | | | |
| GigabitEthernet 0/1 | 00d0.f800.0001 | 192.168.1.1 | port-security | | | | | | | | | | | | | | | | | | | | | | | | | | | | | | | | | | |
| GigabitEthernet 0/1 | 00d0.f800.0002 | 192.168.1.4 | DHCP snooping | | | | | | | | | | | | | | | | | | | | | | | | | | | | | | | | | | |
| GigabitEthernet 0/4 | 00d0.f800.0003 | 192.168.1.3 | address-bind | | | | | | | | | | | | | | | | | | | | | | | | | | | | | | | | | | |
| GigabitEthernet 0/4 | | 192.168.1.5 | port-security | | | | | | | | | | | | | | | | | | | | | | | | | | | | | | | | | | |
| GigabitEthernet 0/5 | 00d0.f800.0003 | 192.168.1.3 | address-bind | | | | | | | | | | | | | | | | | | | | | | | | | | | | | | | | | | |
| INTERFACE | SENDER MAC | SENDER IP | POLICY SOURCE | | | | | | | | | | | | | | | | | | | | | | | | | | | | | | | | | | |
| Wlan 1 | 0026.c79f.6e4c | 172.168.131.1 | DHCP snooping | | | | | | | | | | | | | | | | | | | | | | | | | | | | | | | | | | |

Common Errors

- If ARP packets at a port need to be checked but APR-Check is disabled, then APR-Check will not be effective.

5.5 Monitoring

Displaying

| Description | Command |
|---|---|
| Displays the effective ARP Check list based on ports. | show interfaces [<i>interface-type interface-number</i>] arp-checklist |
| Displays the effective ARP Check list based on WLAN. | show wlan [<i>wlan-id</i>] arp-checklist |

6 Configuring Gateway-targeted ARP Spoofing Prevention

6.1 Overview

Gateway-targeted Address Resolution Protocol (ARP) spoofing prevention effectively prevents gateway-targeted ARP spoofing by checking on the logical port whether the source IP addresses of ARP packets (Sender IP fields of ARP packets) are the self-configured gateway IP addresses.

Protocols and Standards

RFC 826: Ethernet Address Resolution Protocol

6.2 Applications

N/A

6.3 Features

Basic Concepts

↳ ARP

ARP is a TCP/IP protocol that obtains physical addresses according to IP addresses. Its function is as follows: The host broadcasts ARP requests to all hosts on the network and receives the returned packets to determine physical addresses of the target IP addresses, and saves the IP addresses and hardware addresses in the local ARP cache, which can be directly queried in response to future requests. On the same network, all the hosts using the ARP are considered as mutually trustful to each other. Each host on the network can independently send ARP response packets; the other hosts receive the response packets and record them in the local ARP cache without detecting their authenticity. In this way, attackers can send forged ARP response packets to target hosts so that the messages sent from these hosts cannot reach the proper host or reach a wrong host, thereby causing ARP spoofing.

↳ Gateway-targeted ARP Spoofing

When User A sends an ARP packet requesting the media access control (MAC) address of a gateway, User B on the same VLAN also receives this packet, and User B can send an ARP response packet, passing off the gateway IP address as the source IP address of the packet, and User B's MAC address as the source MAC address. This is called gateway-targeted ARP spoofing. After receiving the ARP response, User A regards User B's machine as the gateway, so all the packets sent from User A to the gateway during communication will be sent to User B. In this way, User A's communications are intercepted, thereby causing ARP spoofing.

Overview

| Feature | Description |
|--|--|
| Gateway-targeted ARP Spoofing Prevention | Blocks ARP spoofing packets with forged gateway address and intranet server IP addresses to ensure that users can access the Internet. |

6.3.1 Gateway-targeted ARP Spoofing Prevention

Working Principle

▾ Gateway-targeted Spoofing Prevention

Gateway-targeted ARP spoofing prevention effectively prevents ARP spoofing aimed at gateways by checking on the logical port whether the source IP addresses of ARP packets are the self-configured gateway IP addresses. If an ARP packet uses the gateway address as the source IP address, the packet will be discarded to prevent users from receiving wrong ARP response packets. If not, the packet will not be handled. In this way, only the devices connected to the switch can send ARP packets, and the ARP response packets sent from the other PCs which pass for the gateway are filtered by the switch.

Related Configuration

▾ Configuring Gateway-targeted Spoofing Prevention Addresses

- By default, no gateway-targeted ARP spoofing prevention address is configured.
- Run the **anti-arp-spoofing ip** command to configure the gateway-targeted ARP spoofing prevention addresses.

6.4 Configuration

| Configuration | Description and Command |
|--|--|
| Configuring Gateway-targeted Spoofing Prevention |  Optional. |
| | anti-arp-spoofing ip Configures gateway-targeted ARP spoofing prevention on the logical port and specifies the gateway IP address. |

6.4.1 Configuring Gateway-targeted Spoofing Prevention

Configuration Effect

Enable gateway-targeted ARP spoofing prevention.

Configuration Steps

▾ Configuring Gateway-targeted Spoofing Prevention

- Gateway-targeted ARP spoofing prevention is mandatory. It must be enabled.

Verification

- Run the **show run** command to check configuration.
- Run the **show anti-arp-spoofing** command to display all data on gateway-targeted ARP spoofing prevention.

Related Commands

▾ [Configuring Gateway-targeted Spoofing Prevention](#)

| | |
|------------------------------|--|
| Command | anti-arp-spoofing ip <i>ip-address</i> |
| Parameter Description | <i>ip-address</i> : Indicates the IP address of the gateway. |
| Command Mode | wireless security configuration mode |
| Usage Guide | |

Configuration Example

N/A

6.5 Monitoring

Displaying

| Description | Command |
|--|-------------------------------|
| Displays all data on gateway-targeted ARP spoofing prevention. | show anti-arp-spoofing |

7 Configuring Global IP-MAC Binding

7.1 Overview

Enable the global IP-MAC binding function manually to verify the input packets. If a specified IP address is bound with a MAC address, the device receives only the IP packets containing matched IP address and MAC address. The other packets are discarded.

The address bounding feature is used to verify the input packets. Note that the address binding feature takes precedence over the 802.1X authentication, port security, and access control list (ACL).

7.2 Applications

N/A

| Application | Description |
|---------------------------------------|---|
| Global IP-MAC Binding | Only hosts with the specified IP addresses can access the network, and the hosts connected to a device can move freely. |

7.2.1 Global IP-MAC Binding

Scenario

The administrator assigns a fixed IP address for each host to facilitate management.

- Only hosts with the specified IP addresses can access the external network, which prevents IP address embezzlement by unauthorized hosts.
- Hosts can move freely under the same device.

Figure 7-1

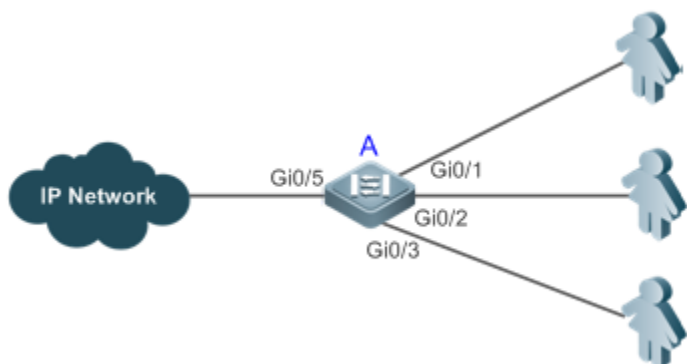

| | |
|----------------|------------------------|
| Remarks | A is an access device. |
|----------------|------------------------|

A user is a host configured with a static IP address.
IP Network is an external IP network.

Deployment

- Manually configure the global IP-MAC binding. (Take three users as an example.)

| User | MAC Address | IP Address |
|--------|----------------|--------------|
| User 1 | 00d0.3232.0001 | 192.168.1.10 |
| User 2 | 00d0.3232.0002 | 192.168.1.20 |
| User 3 | 00d0.3232.0003 | 192.168.1.30 |

- Enable the IP-MAC binding function globally.
- Configure the uplink port (Gi0/5 port in this example) of the device as the exclude port.

7.3 Features

Basic Concepts

IPv6 Address Binding Mode

IPv6 address binding modes include Compatible, Loose, and Strict. The default mode is Strict. If IPv4-MAC binding is not configured, the IPv6 address binding mode does not take effect, and all IPv4 and IPv6 packets are allowed to pass through. If IPv4-MAC binding is configured, the IPv6 address binding mode takes effect, and the device forwards IPv4 and IPv6 packets based on the forwarding rules described in the following table:

| Mode | IPv4 Packet Forwarding Rule | IPv6 Packet Forwarding Rule |
|------------|---|---|
| Strict | Packets matching the global IPv4-MAC binding are forwarded. | Packets matching the global IPv6-MAC binding are forwarded. (The binding is generated by other access security functions, such as port security and IPv6 Source Guard.) |
| Loose | Packets matching the global IPv4-MAC binding are forwarded. | If IPv6+MAC address binding is configured, packets matching the IPv6-MAC binding are forwarded. (The binding is generated by other access security functions, such as port security and IPv6 Source Guard.) If IPv6-MAC binding does not exist, all IPv6 packets are forwarded. |
| Compatible | Packets matching the global IPv4-MAC binding are forwarded. | If the IPv6 packets contain a MAC address matching the MAC address in the IPv4-MAC binding, the IPv6 packets are forwarded. Packets matching the global IPv6-MAC binding conditions are forwarded. (The binding is generated by other access security functions, such as port security and IPv6 Source Guard.) |

Exclude Port

By default, the IP-MAC binding function takes effect on all ports of the device. You can configure exclude ports so that the address binding function does not take effect on these ports. In practice, the IP-MAC bindings of the input packets on the uplink port are not fixed. Generally, the uplink port of the device is configured as the exclude port so that the packets on the uplink port are not checked for IP-MAC binding.

Overview

| Feature | Description |
|---|--|
| Configuring Global IP-MAC Binding | Control forwarding of IPv4 or IPv6 packets. |
| Configuring the IPv6 Address Binding Mode | Change the IPv6 packet forwarding rules. |
| Configuring the Exclude Port | Disable the global address binding function on the specified port. |

7.3.1 Configuring Global IP-MAC Binding

Working Principle

Enable the global IP-MAC binding function manually to verify the input packets. If a specified IP address is bound with a MAC address, the device receives only the IP packets containing matched IP address and MAC address. The other packets are discarded.

Related Configuration

▾ [Configuring IP-MAC Binding](#)

Run the **address-bind** command in global configuration mode to add or delete an IPv4-MAC binding.

▾ [Enabling the IP-MAC Binding Function](#)

Run the **address-bind install** command in global configuration mode to enable the IP-MAC binding function. By default, this function is disabled.

7.3.2 Configuring the IPv6 Address Binding Mode

Working Principle

After the global IPv4-MAC binding is configured and enabled, IPv6 packets are forwarded based on the IPv6 address binding mode. IPv6 binding modes include Compatible, Loose, and Strict.

Related Configuration

▾ [Configuring the IPv6 Address Binding Mode](#)

By default, the IPv6 address binding mode is Strict.

Run the **address-bind ipv6-mode** command to specify an IPv6 address binding mode.

7.3.3 Configuring the Exclude Port

Working Principle

Configure an exclude port so that the address binding function does not take effect on this port.

Related Configuration

↘ [Configuring the Exclude Port](#)

Run the **address-bind uplink** command to configure an exclude port. By default, no port is the exclude port.

7.4 Configuration

| Configuration | Description and Command | |
|---|---|---|
| Configuring Global IP-MAC Address Binding | ⚠ (Mandatory) It is used to configure and enable address binding. | |
| | address-bind | Configures global IP-MAC binding. |
| | address-bind install | Enables the address binding. |
| Configuring the IPv6 Address Binding Mode | ⚠ (Optional) It is used to configure the IPv6 address binding mode. | |
| | address-bind ipv6-mode | Configures the IPv6 address binding mode. |
| Configures the Exclude Port | ⚠ (Optional) It is used to configure the exclude port. | |
| | address-bind uplink | Configures the exclude port. |

7.4.1 Configuring Global IP-MAC Binding

Configuration Effect

- Configure a global IPv4-MAC binding.
- Enable the address binding function to control forwarding of the IPv4 or IPv6 packets.

Notes

- If you run the **address-bind install** command without IP-MAC binding configured, IP-MAC binding does not take effect and all packets are allowed to pass through.

Configuration Steps

↘ [Configuring Global IP-MAC Binding](#)

- (Mandatory) Perform this configuration in global configuration mode.

↘ [Enabling the Address Binding Function](#)

- (Mandatory) Perform this configuration in global configuration mode.

Verification

Run the **show run** or **show address-bind** command to check whether the configuration takes effect.

Related Commands

Configuring Global IP-MAC Binding

| | |
|----------------------------|---|
| Command | address-bind { <i>ip-address</i> <i>ipv6-address</i> } <i>mac-address</i> |
| Parameter | <i>ip-address</i> : Indicates the bound IPv4 address. |
| Description | <i>ipv6-address</i> : Indicates the bound IPv6 address. <i>mac-address</i> : Indicates the bound MAC address. |
| Command Mode | Global configuration mode |
| Configuration Usage | Run this command to configure the binding relationship between an IPv4/IPv6 address and a MAC address. This command is not supported on ACs. |

Enabling the Address Binding Function

| | |
|----------------------------|---|
| Command | address-bind install |
| Parameter | N/A |
| Description | |
| Command Mode | Global configuration mode |
| Configuration Usage | Run this command to enable the global IP-MAC binding function. This function is used to control forwarding of IPv4 or IPv6 packets. This command is not supported on ACs. |

Configuration Example

Configuring Global IP-MAC Binding and Enabling Address Binding

| | |
|----------------------------|---|
| Configuration Steps | <ul style="list-style-type: none"> Configure a global IPv4-MAC binding. Enable the address binding function. |
| | <pre>Ruijie# configure terminal Enter configuration commands, one per line. End with CNTL/Z. Ruijie(config)# address-bind 192.168.5.1 00d0.f800.0001 Ruijie(config)# address-bind install</pre> |
| Verification | Display the global IP-MAC binding on the device. |
| | <pre>Ruijie#show address-bind Total Bind Addresses in System : 1 IP Address Binding MAC Addr</pre> |

| | |
|--|---|
| | <pre>-----</pre> <pre>192.168.5.1 00d0.f800.0001</pre> |
|--|---|

7.4.2 Configuring the IPv6 Address Binding Mode

Configuration Effect

- Change the IPv6 address binding mode so as to change the forwarding rules for IPv6 packets.

Configuration Steps

▾ Configuring the IPv6 Address Binding Mode

- (Optional) Perform this configuration when you want to change the forwarding rules for IPv6 packets.

Verification

- Run the **show run** command to check whether the configuration takes effect.

Related Commands

▾ Configuring the IPv6 Address Binding Mode

| | |
|------------------------------|---|
| Command | address-bind ipv6-mode { compatible loose strict } |
| Parameter Description | compatible: Indicates the Compatible mode. loose: Indicates the Loose mode. strict: Indicates the strict mode. |
| Command Mode | Global configuration mode |
| Configuration Usage | N/A |

Configuration Example

▾ Configuring the IPv6 Address Binding Mode

| | |
|----------------------------|---|
| Configuration Steps | <ul style="list-style-type: none"> ● Configure a global IP-MAC binding. ● Enable the address binding function. ● Set the IPv6 address binding mode to Compatible. |
| | <pre>Ruijie# configure terminal</pre> <p>Enter configuration commands, one per line. End with CNTL/Z.</p> <pre>Ruijie(config)# address-bind 192.168.5.1 00d0.f800.0001</pre> <pre>Ruijie(config)# address-bind install</pre> <pre>Ruijie(config)# address-bind ipv6-mode compatible</pre> |

| | |
|---------------------|---|
| Verification | Run the show run command to display the configuration on the device. |
|---------------------|---|

7.4.3 Configuring the Exclude Port

Configuration Effect

- The address binding function is disabled on the exclude port, and all IP packets can be forwarded.

Notes

- The configuration can be performed only on a switching port or an L2 aggregate port.

Configuration Steps

▾ Configuring the Exclude Port

- (Optional) Perform this configuration in global configuration mode when you want to disable the address binding function on a specified port.

Verification

Run the **show run** or **show address-bind uplink** command to check whether the configuration takes effect.

Related Commands

▾ Configuring the Exclude Port

| | |
|------------------------------|---|
| Command Syntax | address-bind uplink <i>interface-id</i> |
| Parameter Description | <i>interface-id</i> : Indicates the ID of a switching port or an L2 aggregate port. |
| Command Mode | Global configuration mode |
| Configuration Usage | N/A |

Configuration Example

▾ Configuring the Exclude Port

| | |
|----------------------------|---|
| Configuration Steps | <ul style="list-style-type: none"> ● Create a global IPv4-MAC binding. ● Enable the address binding function. ● Configure an exclude port. |
| | <pre>Ruijie# configure terminal Enter configuration commands, one per line. End with CNTL/Z. Ruijie(config)# address-bind 192.168.5.1 00d0.f800.0001</pre> |

| | |
|---------------------|--|
| | <pre>Ruijie(config)# address-bind install Ruijie(config)# address-bind uplink GigabitEthernet 0/1</pre> |
| Verification | Display the global IP-MAC binding on the device. |
| | <pre>Ruijie#show address-bind Total Bind Addresses in System : 1 IP Address Binding MAC Addr ----- 192.168.5.1 00d0.f800.0001 Ruijie#show address-bind uplink Port State ----- Gi0/1 Enabled Default Disabled</pre> |

7.5 Monitoring

Displaying

| Description | Command |
|--|---------------------------------|
| Displays the IP-MAC binding on the device. | show address-bind |
| Displays the exclude port. | show address-bind uplink |

8 Configuring DHCP Snooping

8.1 Overview

DHCP Snooping: DHCP Snooping snoops DHCP interactive packets between clients and servers to record and monitor users' IP addresses and filter out illegal DHCP packets, including client request packets and server response packets. The legal user database generated from DHCP Snooping records may serve security applications like IP Source Guard.

Protocols and Standards

- RFC 2131: Dynamic Host Configuration Protocol
- RFC 2132: DHCP Options and BOOTP Vendor Extensions

8.2 Applications

| Application | Description |
|--|--|
| Guarding against DHCP service spoofing | In a network with multiple DHCP servers, DHCP clients are allowed to obtain network configurations only from legal DHCP servers. |
| Guarding against DHCP packet flooding | Malicious network users may frequently send DHCP request packets. |
| Guarding against forged DHCP packets | Malicious network users may send forged DHCP request packets, for example, DHCP-RELEASE packets. |
| Guarding against IP/MAC spoofing | Malicious network users may send forged IP packets, for example, tampered source address fields of packets. |
| Preventing Lease of IP Addresses | Network users may lease IP addresses rather than obtaining them from a DHCP server. |
| Detecting ARP attack | Malicious users forge ARP response packets to intercept packets during normal users' communication. |

8.2.1 Guarding Against DHCP Service Spoofing

Scenario

Multiple DHCP servers may exist in a network. It is essential to ensure that user PCs obtain network configurations only from the DHCP servers within a controlled area.

Take the following figure as an example. The DHCP client can only communicate with trusted DHCP servers.

- Request packets from the DHCP client can be transmitted only to trusted DHCP servers.
- Only the response packets from trusted DHCP servers can be transmitted to the client.

Figure 8-1

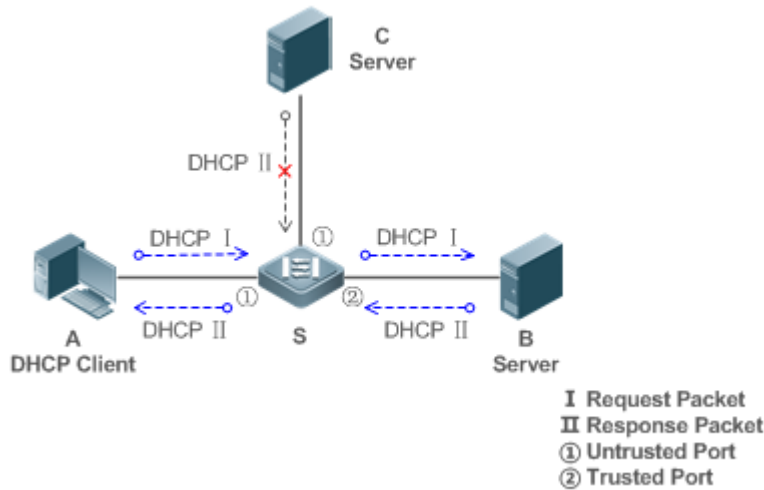

| | |
|-----------------|--|
| Remarks: | <p>S is an access device.</p> <p>A is a user PC.</p> <p>B is a DHCP server within the controlled area.</p> <p>C is a DHCP server out of the controlled area.</p> |
|-----------------|--|

Deployment

- Enable DHCP Snooping on S to realize DHCP packet monitoring.
- Set the port on S connecting to B as trusted to transfer response packets.
- Set the rest of ports on S as untrusted to filter response packets.

8.2.2 Guarding Against DHCP Packet Flooding

Scenario

Potential malicious DHCP clients in a network may send high-rate DHCP packets. As a result, legitimate users cannot obtain IP addresses, and access devices are highly loaded or even break down. It is necessary to take actions to ensure network stability.

With the DHCP Snooping rate limit function for DHCP packets, a DHCP client can only send DHCP request packets at a rate below the limit.

- The request packets from a DHCP client are sent at a rate below the limit.
- Packets sent at rates beyond the limit will be discarded.
- Enable DHCP Snooping correlation with ARP, and delete the non-existing entries.

Deployment

- Enable DHCP Snooping on S to realize DHCP monitoring.
- Limit the rates of DHCP packets from the untrusted ports.

- Enable DHCP Snooping correlation with ARP, and detect whether the user is online.

8.2.3 Guarding Against Forged DHCP Packets

Scenario

Potential malicious clients in a network may forge DHCP request packets, consuming applicable IP addresses from the servers and probably preempting legal users' IP addresses. Therefore, it is necessary to filter out illegal DHCP packets.

For example, as shown in the figure below, the DHCP request packets sent from DHCP clients will be checked.

- The source MAC address fields of the request packets from DHCP clients must match the **chaddr** fields of DHCP packets.
- The Release packets and Decline packets from clients must match the entries in the DHCP Snooping binding database.

Figure 8-2

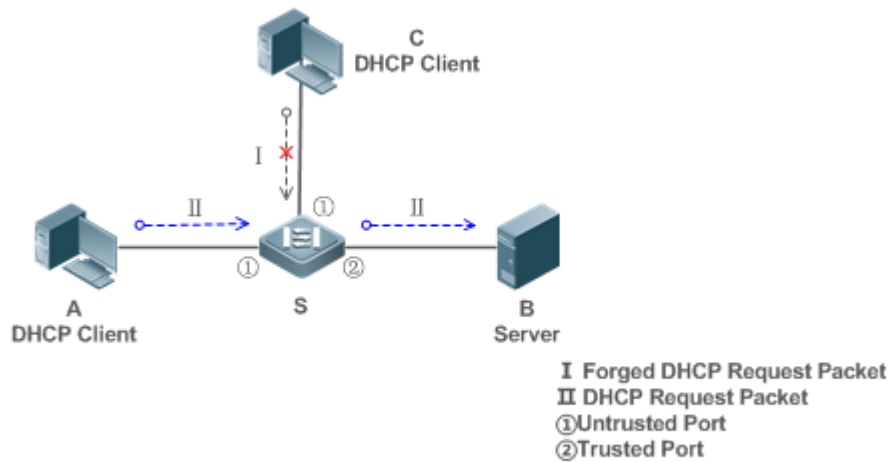

| | |
|-----------------|--|
| Remarks: | <p>S is an access device.</p> <p>A and C are user PCs.</p> <p>B is a DHCP server within the controlled area.</p> |
|-----------------|--|

Deployment

- Enable DHCP Snooping on S to realize DHCP monitoring.
- Set the port on S connecting to B as trusted to transfer response packets.
- Set the rest of ports on S as untrusted to filter response packets.
- Enable DHCP Snooping Source MAC Verification on untrusted ports of S to filter out illegal packets.

8.2.4 Guarding Against IP/MAC Spoofing

Scenario

Check IP packets from untrusted ports to filter out forged IP packets based on IP or IP-MAC fields.

For example, in the following figure, the IP packets sent by DHCP clients are validated.

- The source IP address fields of IP packets must match the IP addresses assigned by DHCP.
- The source MAC address fields of layer-2 packets must match the **chaddr** fields in DHCP request packets from clients.

Figure 8-3

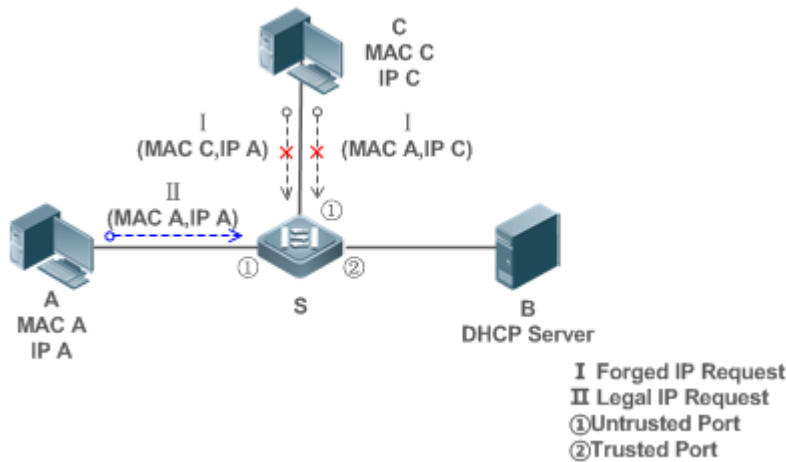

| | |
|-----------------|--|
| Remarks: | <p>S is an access device.</p> <p>A and C are user PCs.</p> <p>B is a DHCP server within the controlled area.</p> |
|-----------------|--|

Deployment

- Enable DHCP Snooping on S to realize DHCP monitoring.
- Set all downlink ports on the S as DHCP Snooping untrusted.
- Enable IP Source Guard on S to filter IP packets.
- Enable IP Source Guard in IP-MAC based mode to check the source MAC and IP address fields of IP packets.

8.2.5 Preventing Lease of IP Addresses

Scenario

Validate the source addresses of IP packets from untrusted ports compared with DHCP-assigned addresses.

If the source addresses, connected ports, and layer-2 source MAC addresses of ports in IP packets do not match the assignments of the DHCP server, such packets will be discarded.

The networking topology scenario is the same as that shown in the previous figure.

Deployment

- The same as that in the section "Guarding Against IP/MAC Spoofing".

8.2.6 Detecting ARP Attacks

Scenario

Check the ARP packets from untrusted ports and filter out the ARP packets unmatched with the assignments of the DHCP server.

For example, in the following figure, the ARP packets sent from DHCP clients will be checked.

- The ports receiving ARP packets, the layer-2 MAC addresses, and the source MAC addresses of ARP packets senders shall be consistent with the DHCP Snooping histories.

Figure 8-4

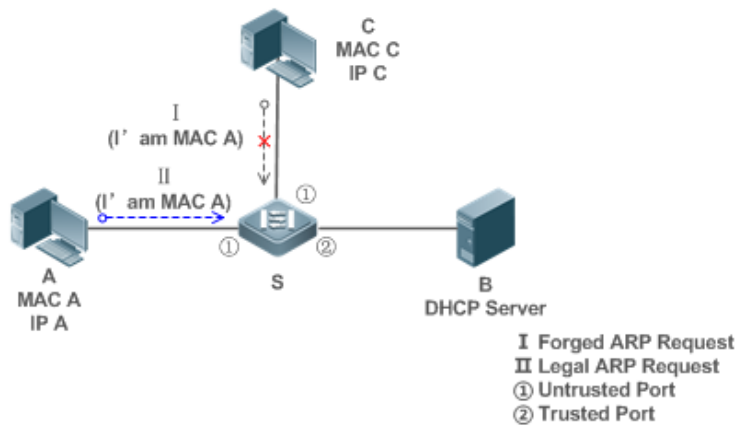

| | |
|-----------------|---|
| Remarks: | S is an access device. A and C are user PCs. B is a DHCP server within the controlled area. |
|-----------------|---|

Deployment

- Enable DHCP Snooping on S to realize DHCP monitoring.
- Set all downlink ports on the S as untrusted.
- Enable IP Source Guard and ARP Check on all the untrusted ports on S to realize ARP packet filtering.

⚠ All the above security control functions are only effective to DHCP Snooping untrusted ports.

8.3 Features

Basic Concepts

↳ DHCP Request Packets

Request packets are sent from a DHCP client to a DHCP server, including DHCP-DISCOVER packets, DHCP-REQUEST packets, DHCP-DECLINE packets, DHCP-RELEASE packets and DHCP-INFORM packets.

↳ DHCP Response Packets

Response packets are sent from a DHCP server to a DHCP client, including DHCP-OFFER packets, DHCP-ACK packets and DHCP-NAK packets.

↳ DHCP Snooping Trusted Ports

IP address request interaction is complete via broadcast. Therefore, illegal DHCP services will influence normal clients' acquisition of IP addresses and lead to service spoofing and stealing. To prevent illegal DHCP services, DHCP Snooping ports are divided into two types: trusted ports and untrusted ports. The access devices only transmit DHCP response packets received on trusted ports, while such packets from untrusted ports are discarded. In this way, we may configure the ports connected to a legal DHCP Server as trusted and the other ports as untrusted to shield illegal DHCP Servers.

On switches, all switching ports or layer-2 aggregate ports are defaulted as untrusted, while trusted ports can be specified. On wireless access points (APs), all the WLAN interfaces are untrusted and cannot be specified as trusted. In fat AP configuration mode, all the layer-2 switching ports and layer-2 encapsulation sub-interfaces are untrusted by default, and can be specified as trusted. In fit AP configuration mode, all the layer-2 switching ports are untrusted by default and can be specified as trusted, and all the layer-2 encapsulation sub-interfaces are trusted and cannot be specified as untrusted. On wireless access controllers (ACs), all WLAN interfaces are untrusted ports and cannot be specified as trusted, and all the switching ports and layer-2 aggregate ports are untrusted ports by default and can be specified as trusted.

↳ DHCP Snooping Packet Suppression

To shield all the DHCP packets on a specific client, we can enable DHCP Snooping packet suppression on its untrusted ports.

↳ VLAN-based DHCP Snooping

DHCP Snooping can work on a VLAN basis. By default, when DHCP Snooping is enabled, it is effective to all the VLANs of the current client. Specify VLANs help control the effective range of DHCP Snooping flexibly.

↳ DHCP Snooping Binding Database

In a DHCP network, clients may set static IP addresses randomly. This increases not only the difficulty of network maintenance but also the possibility that legal clients with IP addresses assigned by the DHCP server may fail to use the network normally due to address conflict. Through snooping packets between clients and servers, DHCP Snooping summarizes the user entries including IP addresses, MAC address, VLAN ID (VID), ports and lease time to build the DHCP

Snooping binding database. Combined with ARP detection and ARP check, DHCP Snooping controls the reliable assignment of IP addresses for legal clients.

↘ DHCP Snooping Rate Limit

DHCP Snooping rate limit function can be configured through the rate limit command of Network Foundation Protection Policy (NFPP). For NFPP configuration, see the *Configuring NFPP*.

↘ DHCP Option82

DHCP Option82, an option for DHCP packets, is also called DHCP Relay Agent Information Option. As the option number is 82, it is known as Option82. Option82 is developed to enhance the security of DHCP servers and improve the strategies of IP address assignment. The option is often configured for the DHCP relay services of a network access device like DHCP Relay and DHCP Snooping. This option is transparent to DHCP clients, and DHCP relay components realize the addition and deduction of the option.

↘ Illegal DHCP Packets

Through DHCP Snooping, validation is performed on the DHCP packets passing through a client. Illegal DHCP packets are discarded, user information is recorded into the DHCP Snooping binding database for further applications (for example, ARP detection). The following types of packets are considered illegal DHCP packets.

- The DHCP response packets received on untrusted ports, including DHCP-ACK, DHCP-NACK and DHCP-OFFER packets
- The DHCP request packets carrying gateway information **giaddr**, which are received on untrusted ports
- When MAC verification is enabled, packets with source MAC addresses different with the value of the **chaddr** field in DHCP packets
- DHCP-RELEASE packets with the entry in the DHCP Snooping binding database Snooping while with untrusted ports inconsistent with settings in this binding database
- DHCP packets in wrong formats, or incomplete

Overview

| Feature | Description |
|---|--|
| Filtering DHCP packets | Perform legality check on DHCP packets and discard illegal packets (see the previous section for the introduction of illegal packets). Transfer requests packets received on trusted ports only. |
| Building the DHCP Snooping binding database | Snoop the interaction between DHCP clients and the server, and generate the DHCP Snooping binding database to provide basis for other filtering modules. |

8.3.1 Filtering DHCP Packets

Perform validation on DHCP packets from untrusted ports. Filter out the illegal packets as introduced in the previous section "Basic Concepts".

Working Principle

During snooping, check the receiving ports and the packet fields of packets to realize packet filtering, and modify the destination ports of packets to realize control of transmit range of the packets.

↘ Checking Ports

In receipt of DHCP packets, a client first judges whether the packet receiving ports are DHCP Snooping trusted ports. If yes, legality check and binding entry addition are skipped, and packets are transferred directly. For not, both the check and addition are needed.

↘ Checking Packet Encapsulation and Length

A client checks whether packets are UDP packets and whether the destination port is 67 or 68. Check whether the packet length match the length field defined in protocols.

↘ Checking Packet Fields and Types

According to the types of illegal packet introduced in the section "Basic Concepts", check the fields **giaddr** and **chaddr** in packets and then check whether the restrictive conditions for the type of the packet are met.

Related Configuration

↘ Enabling Global DHCP Snooping

By default, DHCP Snooping is disabled.

It can be enabled on a device using the **ip dhcp snooping** command.

Global DHCP Snooping must be enabled before VLAN-based DHCP Snooping is applied.

↘ Configuring VLAN-based DHCP Snooping

By default, when global DHCP Snooping is effective, DHCP Snooping is effective to all VLANs.

Use the [**no**] **ip dhcp snooping vlan** command to enable DHCP Snooping on specified VLANs or delete VLANs from the specified VLANs. The value range of the command parameter is the actual range of VLAN numbers.

↘ Configuring DHCP Snooping Source MAC Verification

By default, the layer-2 MAC addresses of packets and the **chaddr** fields of DHCP packets are not verified.

When the **ip dhcp snooping verify mac-address** command is used, the source MAC addresses and the **chaddr** fields of the DHCP request packets sent from untrusted ports are verified. The DHCP request packets with different MAC addresses will be discarded.

8.3.2 Building the Binding Database

DHCP Snooping detects the interactive packets between DHCP clients and the DHCP server, and generate entries of the DHCP Snooping binding database according to the information of legal DHCP packets. All these legal entries are provided to other security modules of a client as the basis of filtering packets from network.

Working Principle

During snooping, the binding database is updated timely based on the types of DHCP packets.

Generating Binding Entries

When a DHCP-ACK packet on a trusted port is snooped, the client's IP address, MAC address, and lease time field are extracted together with the port ID (a wired interface index or a WLAN ID) and VLAN ID. Then, a binding entry of it is generated.



Deleting Binding Entries

When the recorded lease time of a binding entry is due, it will be deleted if a legal DHCP-RELEASE/DHCP-DECLINE packet sent by the client or a DHCP-NCK packet received on a trusted port is snooped, or the **clear** command is used.

Related Configuration

No configuration is needed except enabling DHCP Snooping.

8.4 Configuration

| Configuration | Description and Command | |
|--|---|---|
| Configuring basic functions of DHCP Snooping |  (Mandatory) It is used to enable DHCP Snooping. | |
| | ip dhcp snooping | Enables DHCP Snooping. |
| | ip dhcp snooping suppression | Enables DHCP Snooping packet suppression. |
| | ip dhcp snooping vlan | Enables VLAN-based DHCP Snooping. |
| | ip dhcp snooping verify mac-address | Configures DHCP Snooping source MAC verification. |
| | ip dhcp snooping database write-delay | Writes the DHCP Snooping binding database to Flash periodically. |
| | ip dhcp snooping database write-to-flash | Writes the DHCP Snooping binding database to Flash manually. |
| | renew ip dhcp snooping database | Imports Flash storage to the DHCP Snooping Binding database. |
| | ip dhcp snooping trust | Configures DHCP Snooping trusted ports. |
| | ip dhcp snooping bootp | Enables BOOTP support. |
| Configuring Option82 | ip dhcp snooping check-giaddr | Enables DHCP Snooping to support the function of processing Relay requests. |
| | ip dhcp snooping clear-broadcast-flag | Enables the function of clearing the broadcast flag bit. |
| |  (Optional) It is used to optimize the address assignment by DHCP servers. | |

| | | |
|--|---|---|
| | ip dhcp snooping information option | Adds Option82 functions to DHCP request packets. |
| | ip dhcp snooping information option format remote-id | Configures the sub-option remote-id of Option82 as a user-defined character string. |
| | ip dhcp snooping vlan information option format-type circuit-id string | Configures the sub-option circuit-id of Option82 as a user-defined character string. |

8.4.1 Configuring Basic Features

Configuration Effect

- Enable DHCP Snooping.
- Generate the DHCP Snooping binding database.
- Control the transmit range of DHCP packets.
- Filter out illegal DHCP packets.

Notes

- The ports on clients connecting a trusted DHCP server must be configured as trusted.
- DHCP Snooping is effective on the wired switching ports, layer-2 aggregate ports, and layer-2 encapsulation sub-interfaces, as well as WLAN interfaces. The configuration can be implemented in interface configuration mode and WLAN security configuration mode.

Configuration Steps

▾ Enabling Global DHCP Snooping

- Mandatory.
- Unless otherwise noted, the feature should be configured on access devices.

▾ Enabling or Disabling VLAN-based DHCP Snooping

- DHCP Snooping can be disabled if not necessary for some VLANs.
- Unless otherwise noted, the feature should be configured on access devices.

▾ Configuring DHCP Snooping Trusted Ports

- Mandatory.
- Configure the ports connecting a trusted DHCP server as trusted.

▾ Enabling DHCP Snooping Source MAC Validation

- This configuration is required if the **chaddr** fields of DHCP request packets match the layer-2 source MAC addresses of data packets.
- Unless otherwise noted, the feature should be enabled on all the untrusted ports of access devices.

✚ Writing the DHCP Snooping Binding Database to Flash Periodically

- Enable this feature to timely save the DHCP Snooping binding database information in case that client reboot.
- Unless otherwise noted, the feature should be configured on access devices.

✚ Enabling BOOTP Support

- Optional
- Unless otherwise noted, the feature should be configured on access devices.

✚ Enabling DHCP Snooping to Process Relay Requests

- Optional.
- Unless otherwise noted, the feature should be enabled on access devices.

✚ Enabling DHCP Snooping to Clear the Broadcast Flag Bit

- Optional.
- Unless otherwise noted, the feature should be enabled in large Layer-2 wireless scenarios.

Verification

Configure a client to obtain network configurations through the DHCP protocol.

- Check whether the DHCP Snooping Binding database is generated with entries on the client.

Related Commands

✚ Enabling or Disabling DHCP Snooping

| | |
|---------------------|--|
| Command | <code>[no] ip dhcp snooping</code> |
| Parameter | N/A |
| Description | |
| Command Mode | Global configuration mode |
| Usage Guide | After global DHCP Snooping is enabled, you can check DHCP Snooping using the show ip dhcp snooping command. |

✚ Configuring VLAN-based DHCP Snooping

| | |
|---------------------|---|
| Command | <code>[no] ip dhcp snooping vlan { <i>vlan-rng</i> { <i>vlan-min</i> [<i>vlan-max</i>] } }</code> |
| Parameter | <i>vlan-rng</i> : Indicates the range of VLANs |
| Description | <i>vlan-min</i> : The minimum VLAN ID <i>vlan-max</i> : The maximum VLAN ID |
| Command Mode | Global configuration mode |
| Usage Guide | Use this command to enable or disable DHCP Snooping on specified VLANs. This feature is available only |

after global DHCP Snooping is enabled.

✚ Configuring DHCP Snooping Packet Suppression

| | |
|------------------------------|---|
| Command | [no] ip dhcp snooping suppression |
| Parameter Description | N/A |
| Command Mode | Interface configuration mode/WLAN security configuration mode |
| Usage Guide | Use this command to reject all DHCP request packets at the port, that is, to forbid all users under the port to apply for addresses via DHCP. |

✚ Configuring DHCP Snooping Source MAC Verification

| | |
|------------------------------|---|
| Command | [no] ip dhcp snooping verify mac-address |
| Parameter Description | N/A |
| Command Mode | Global configuration mode |
| Usage Guide | Through the source MAC address verification, the MAC addresses in link headers and the CLIENT MAC fields in the request packets sent by a DHCP CLIENT are checked for consistence. When the source MAC address verification fails, packets will be discarded. |

✚ Writing DHCP Snooping Database to Flash Periodically

| | |
|------------------------------|---|
| Command | [no] ip dhcp snooping database write-delay [time] |
| Parameter Description | <i>time</i> : Indicates the interval between two times of writing the DHCP Snooping database to the Flash. |
| Command Mode | Global configuration mode |
| Usage Guide | Use this command to write the DHCP Snooping database to FLASH document. This can avoid binding information loss which requires re-obtaining IP addresses to resume communication after the device restarts. |

✚ Writing the DHCP Snooping Database to Flash Manually

| | |
|------------------------------|---|
| Command | ip dhcp snooping database write-to-flash |
| Parameter Description | N/A |
| Command Mode | Global configuration mode |
| Usage Guide | Use this command to write the dynamic user information in the DHCP Snooping database in FLASH documents in real time. If a device is upgraded from a non-QinQ version to a QinQ version (or vice versa), binding entries cannot be |

| | |
|--|---|
| | restored from FLASH documents because of version differences between FLASH documents. |
|--|---|

↘ Importing Backup File Storage to the DHCP Snooping Binding Database

| | |
|------------------------------|--|
| Command | renew ip dhcp snooping database |
| Parameter Description | N/A |
| Command Mode | Privileged configuration mode |
| Usage Guide | Use this command to import the information from backup file to the DHCP Snooping binding database. |

↘ Configuring DHCP Snooping Trusted Ports

| | |
|------------------------------|--|
| Command | [no] ip dhcp snooping trust |
| Parameter Description | N/A |
| Command Mode | Interface configuration mode |
| Usage Guide | Use this command to configure a port connected to a legal DHCP server as a trusted port. The DHCP response packets received by trusted ports are transferred, while those received by untrusted ports are discarded. |

↘ Enabling or Disabling BOOTP Support

| | |
|------------------------------|---|
| Command | [no] ip dhcp snooping bootp |
| Parameter Description | N/A |
| Command Mode | Global configuration mode |
| Usage Guide | Use this command to support the BOOTP protocol. |

↘ Enabling DHCP Snooping to Process Relay Requests

| | |
|------------------------------|---|
| Command | [no] ip dhcp snooping check-giaddr |
| Parameter Description | N/A |
| Command Mode | Global configuration mode |
| Usage Guide | <p>After the feature is enabled, services using DHCP Snooping binding entries generated based on Relay requests, such as IP Source Guard/802.1x authentication, cannot be deployed. Otherwise, users fail to access the Internet.</p> <p>After the feature is enabled, the ip dhcp snooping verify mac-address command cannot be used. Otherwise, DHCP Relay requests will be discarded and as a result, users fail to obtain addresses.</p> |

↘ Enabling DHCP Snooping to Clear the Broadcast Flag Bit

| | |
|------------------------------|---|
| Command | [no] ip dhcp snooping clear-broadcast-flag |
| Parameter Description | N/A |
| Command Mode | Global configuration mode |
| Usage Guide | After the feature is enabled, DHCP Snooping checks the broadcast flag bit for non-DHCP Relay requests. If the flag bit is 1, it clears the flag bit. When receiving responses, DHCP Snooping sets the flag bit to 1 and set Layer-2 and Layer-3 destination addresses as broadcast addresses. |

Configuration Example

DHCP Client Obtaining IP addresses Dynamically from a Legal DHCP Server

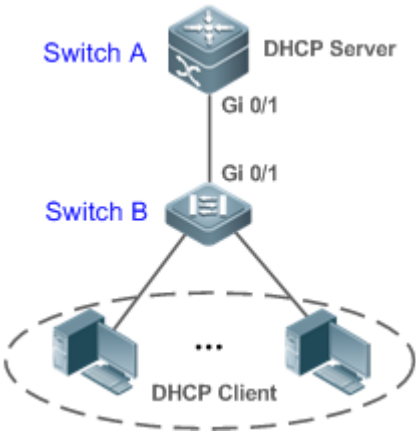
| | |
|---------------------------------------|--|
| <p>Scenario Figure 8-5</p> |  |
| <p>Configuration Steps</p> | <ul style="list-style-type: none"> ● Enable DHCP Snooping on an access device (Switch B in this case). ● Configure the uplink port (port Gi 0/1 in this case) as a trusted port. |
| <p>B</p> | <pre> B#configure terminal Enter configuration commands, one per line. End with CNTL/Z. B(config)#ip dhcp snooping B(config)#interface gigabitEthernet 0/1 B(config-if-GigabitEthernet 0/1)#ip dhcp snooping trust B(config-if-GigabitEthernet 0/1)#end </pre> |
| <p>Verification</p> | <p>Check the configuration on Switch B.</p> <ul style="list-style-type: none"> ● Check whether DHCP Snooping is enabled, and whether the configured DHCP Snooping trusted port is uplink. ● Check the DHCP Snooping configuration on Switch B, and especially whether the trusted port is correct. |
| <p>B</p> | <pre> B#show running-config ! ip dhcp snooping </pre> |

```

!
interface GigabitEthernet 0/1
B#show ip dhcp snooping
Switch DHCP Snooping status           :   ENABLE
DHCP Snooping Verification of hwaddr status :   DISABLE
DHCP Snooping database write-delay time   :   0 seconds
DHCP Snooping option 82 status           :   DISABLE
DHCP Snooping Support BOOTP bind status   :   DISABLE
Interface                               Trusted   Rate limit (pps)
-----                               -
GigabitEthernet 0/1                     YES      unlimited
B#show ip dhcp snooping binding
Total number of bindings: 1
MacAddress          IpAddress      Lease(sec)  Type           VLAN  Interface
-----
0013.2049.9014     172.16.1.2  86207      DHCP-Snooping 1    GigabitEthernet 0/11

```

Common Errors

- The uplink port is not configured as a DHCP trusted port.
- Another access security option is already configured for the uplink port, so that a DHCP trusted port cannot be configured.

8.4.2 Configuring Option82

Configuration Effect

- Enable a DHCP server to obtain more information and assign addresses better.
- The Option82 function is client-oblivious.

Notes

- The Option82 functions for DHCP Snooping and DHCP Relay are mutually exclusive.

Configuration Steps

- To realize optimization of address allocation, implement the configuration.
- Unless otherwise noted, enable this function on access devices with DHCP Snooping enabled.

Verification

Check whether the DHCP Snooping configuration options are configured successfully.

Related Commands

- 📄 [Adding Option82 to DHCP Request Packets](#)

| | |
|------------------------------|---|
| Command | [no] ip dhcp snooping information option [standard-format] |
| Parameter Description | standard-format : Indicates a standard format of the Option82 options |
| Command Mode | Global configuration mode |
| Usage Guide | Use this command to add Option82 to DHCP request packets so that a DHCP server assigns addresses according to such information. |

↘ Configuring Sub-option remote-id of Option82 as User-defined Character String

| | |
|------------------------------|---|
| Command | [no] ip dhcp snooping information option format remote-id { string <i>ASCII-string</i> hostname } |
| Parameter Description | string <i>ASCII-string</i> : Indicates the content of the extensible format, the Option82 option remote-id , is a user-defined character string hostname : Indicates the content of the extensible format, the Option82 option remote-id , is a host name. |
| Configuration mode | Global configuration mode |
| Usage Guide | Use this command to configure the sub-option remote-id of the Option82 as user-defined content, which is added to DHCP request packets. A DHCP server assigns addresses according to Option82 information. |

↘ Configuring Sub-Option circuit -id of Option82 as User-defined Character String

| | |
|------------------------------|--|
| Command | [no] ip dhcp snooping vlan <i>vlan-id</i> information option format-type circuit-id string <i>ascii-string</i> |
| Parameter Description | <i>vlan-id</i> : Indicates the VLAN where a DHCP request packet is <i>ascii-string</i> : Indicates the user-defined string |
| Configuration mode | Interface configuration mode |
| Usage Guide | Use this command to configure the sub-option circuit-id of the Option82 as user-defined content, which is added to DHCP request packets. A DHCP server assigns addresses according to Option82 information. |

Configuration Example

↘ Configuring Option82 to DHCP Request Packets

| | |
|----------------------------|---|
| Configuration Steps | <ul style="list-style-type: none"> Configuring basic functions of DHCP Snooping. Configuring Option82. |
| B | <pre>Ruijie# configure terminal Ruijie(config)# ip dhcp snooping information option Ruijie(config)# end</pre> |
| Verification | Check the DHCP Snooping configuration. |
| B | <pre>B#show ip dhcp snooping Switch DHCP Snooping status : ENABLE DHCP Snooping Verification of hwaddr status : DISABLE DHCP Snooping database write-delay time : 0 seconds</pre> |

| | | |
|---|---------|------------------|
| DHCP Snooping option 82 status | : | ENABLE |
| DHCP Snooping Support bootp bind status | : | DISABLE |
| Interface | Trusted | Rate limit (pps) |
| ----- | ----- | ----- |
| GigabitEthernet 0/1 | YES | unlimited |

Common Errors

- N/A

8.5 Monitoring

Clearing

 Running the clear commands may lose vital information and thus interrupt services.

| Description | Command |
|--|---|
| Clears the DHCP Snooping binding database. | clear ip dhcp snooping binding [<i>ip</i>] [<i>mac</i>] [vlan <i>vlan-id</i>] [interface <i>interface-id</i> wlan <i>wlan-id</i>] |

Displaying

| Description | Command |
|--|--------------------------------------|
| Displays DHCP Snooping configuration. | show ip dhcp snooping |
| Displays the DHCP Snooping binding database. | show ip dhcp snooping binding |

Debugging

 System resources are occupied when debugging information is output. Disable the debugging switch immediately after use.

| Description | Command |
|---|--------------------------------------|
| Debugs DHCP Snooping events. | debug snooping ipv4 event |
| Disables debugging DHCP Snooping events. | no debug snooping ipv4 event |
| Debugs DHCP Snooping packets. | debug snooping ipv4 packet |
| Disables debugging DHCP Snooping packets. | no debug snooping ipv4 packet |

9 Configuring IP Source Guard

9.1 Overview

- The IP Source Guard function realizes hardware-based IP packet filtering to ensure that only the users having their information in the binding database can access networks normally, preventing users from forging IP packets.

9.2 Applications

| Application | Description |
|---|--|
| Guarding Against IP/MAC Spoofing Attack | In network environments, users set illegal IP addresses and malicious users launch attacks through forging IP packets. |

9.2.1 Guarding Against IP/MAC Spoofing Attack

Scenario

Check the IP packets from DHCP untrusted ports. Forged IP packets will be filtered out based on the IP or IP-MAC field.

For example, in the following figure, the IP packets sent by DHCP clients are checked.

- The Source IP Address fields of IP packets should match DHCP-assigned IP addresses.
- The Source MAC Address fields of layer-2 packets should match the MAC addresses in DHCP request packets from clients.

Figure 9-1

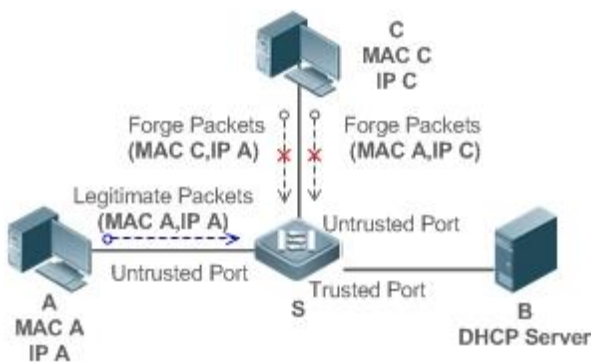

| | |
|-----------------|---|
| Remarks: | S is a network access server (NAS). A and C are user PCs. B is a DHCP server within the control area. |
|-----------------|---|

Deployment

- Enable DHCP Snooping on S to realize DHCP monitoring.
- Set all downlink ports on S as DHCP untrusted ports.
- Enable IP Source Guard on S to realize IP packet filtering.
- Enable IP-MAC match mode for IP Source Guard on S, filtering IP packets based on IP and MAC addresses.

9.3 Features

Basic Concepts

↘ Source IP Address

Indicate the source IP address field of an IP packet.

↘ Source MAC Address

Indicate the source MAC address field of an IP packet.

↘ IP-based Filtering

Indicate a policy of IP packet filtering, where only the source IP addresses of all IP packets (except DHCP packets) passing through a port are checked. It is the default filtering policy of IP Source Guard.

↘ IP-MAC based Filtering

A policy of IP packet filtering, where both the source IP addresses and source MAC addresses of all IP packets are checked, and only those user packets with these IP addresses and MAC addresses existing in the binding database are permitted.

↘ Address Binding Database

As the basis of security control of the IP Source Guard function, the data in the address binding database comes from two ways: the DHCP Snooping binding database and static configuration. When IP Source Guard is enabled, the data of the DHCP Snooping binding database is synchronized to the address binding database of IP Source Guard, so that IP packets can be filtered strictly through IP Source Guard on a device with DHCP Snooping enabled.

↘ Excluded VLAN

By default, when IP Source Guard is enabled on a port, it is effective to all the VLANs under the port. Users may specify excluded VLANs, within which IP packets are not checked and filtered, which means that such IP packets are not controlled by IP Source Guard. At most 32 excluded VLANs can be specified for a port.

Overview

| Feature | Description |
|---|--|
| Checking Source Address Fields of Packets | Filter the IP packets passing through ports by IP-based or IP-MAC based filtering. |

9.3.1 Checking Source Address Fields of Packets

Filter the IP packets passing through ports based on source IP addresses or on both source IP addresses and source MAC addresses to prevent malicious attack by forging packets. When there is no need to check and filter IP packets within a VLAN, an excluded VLAN can be specified to release such packets.

Working Principle

When IP Source Guard is enabled, the source addresses of packets passing through a port will be checked. The port can be a wired switching port, a layer-2 aggregate port (AP), or a layer-2 encapsulation sub-interface, or a WLAN interface. Such packets will pass the port only when the source address fields of the packets match the set of the address binding records generated by DHCP Snooping, or the static configuration set by the administrator. There are two matching modes as below.

↘ IP-based Filtering

Packets are allowed to pass a port only if the source IP address fields of them belong to the address binding database.

↘ IP-MAC Based Filtering

Packets are allowed to pass a port only when both the layer-2 source MAC addresses and layer-3 source IP addresses of them match an entry in the address binding database.

↘ Specifying Excluded VLAN

Packets within such a VLAN are allowed to pass a port without check or filtering.

Related Configuration

↘ Enabling IP Source Guard on a Port

By default, the IP Source Guard is disabled on ports.

It can be enabled using the **ip verify source exclude-vlan** command.

- i** Usually IP Source Guard needs to work with DHCP Snooping. Therefore, DHCP Snooping should also be enabled. DHCP Snooping can be enabled at any time on Ruijie devices, either before or after IP Source Guard is enabled.

↘ Configuring a Static Binding

By default, legal users passing IP Source Guard check are all from the binding database of DHCP Snooping.

Bound users can be added using the **ip source binding** command.

↘ Specifying an Excluded VLAN

By default, IP Source Guard is effective to all the VLANs under a port.

Excluded VLANs may be specified which are exempted from IP Source Guard using the **ip verify source** command.

- i** Excluded VLANs can be specified only after IP Source Guard is enabled on a port. Specified excluded VLANs will be deleted automatically when IP Source Guard is disabled on a port.

- i** The above-mentioned port can be a wired switching port, a layer-2 AP port or a layer-2 encapsulation sub-interface, or a WLAN interface.

9.4 Configuration

| Configuration | Description and Command | |
|---|---|---|
| Configuring IP Source Guard |  (Mandatory) It is used to enable IP Source Guard. | |
| | ip verify source | Enables IP Source Guard on a port. |
| | ip source binding | Configures a static binding. |
| | ip verify source exclude-vlan | Specifies an excluded VLAN for IP Source Guard. |

9.4.1 Configuring IP Source Guard

Configuration Effect

- Check the source IP addresses of input IP packets.

Notes

- When IP Source Guard is enabled, IP packets forwarding may be affected. In general case, IP Source Guard is enabled together with DHCP Snooping.
- IP Source Guard cannot be configured on the trusted ports controlled by DHCP Snooping.
- IP Source Guard cannot be configured on the global IP+MAC exclusive ports.
- IP Source Guard can be configured and enabled only on wired switch ports, Layer-2 AP ports, Layer-2 encapsulation sub-ports and WLAN. In a wired access scenario, it is supposed to be configured in the interface configuration mode. In a wireless access scenario, it is supposed to be configured in the WLAN security configuration mode.

Configuration Steps

- Enable DHCP Snooping.
- Enable IP Source Guard.

Verification

Use the monitoring commands to display the address binding database of IP Source Guard.

Related Commands

▾ Enabling IP Source Guard on a Port

| | |
|-----------|---|
| Command | ip verify source [port-security] |
| Parameter | port-security : Enable IP-MAC based filtering. |

| | |
|--------------------|---|
| Description | |
| Command | Interface configuration mode/WLAN security configuration mode |
| Usage Guide | Detection of users based on IP address or both IP and MAC addresses can be realized by enabling IP Source Guard for a port. |

▾ Configuring a Static Binding

| | |
|------------------------------|---|
| Command | ip source binding <i>mac-address</i> vlan <i>vlan-id</i> [<i>ip-address</i> { interface <i>interface-id</i> wlan <i>wlan-id</i> ip-mac ip-only }] |
| Parameter Description | mac-address: The MAC address of a static binding Vlan-id: The VLAN ID of a static binding. It indicates the outer VLAN ID of a QINQ-termination user. ip-address: The IP address of a static binding <i>interface-id:</i> The Port ID (PID) of a static binding wlan-id: WLAN ID of a static binding ip-mac: IP-MAC based mode ip-only: IP-based mode |
| Configuration Mode | Global configuration mode |
| Usage Guide | Through this command, legitimate users can pass IP Source Guard detection instead of being controlled by DHCP. |

▾ Specifying an Exception VLAN for IP Source Guard

| | |
|------------------------------|---|
| Command | ip verify source exclude-vlan <i>vlan-id</i> |
| Parameter Description | vlan-id: A VLAN ID exempted from IP Source Guard on a port |
| Command | Interface configuration mode/WLAN security configuration mode |
| Usage Guide | By using this command, the specified VLANs under a port where IP Source Guard function is enabled can be exempted from check and filtering. |

Configuration Example

▾ Enabling IP Source Guard on Port 1

| | |
|----------------------------|--|
| Configuration Steps | <ul style="list-style-type: none"> ● Enable DHCP Snooping. ● Enable IP Source Guard. |
| | <pre>Ruijie(config)# interface GigabitEthernet 0/1 Ruijie(config-if-GigabitEthernet 0/1)# ip verify source Ruijie(config-if-GigabitEthernet 0/1)# end Ruijie(config)# wlansec 1 Ruijie(config-wlansec)# ip verify source port-security Ruijie(config-wlansec)# end</pre> |

| | |
|---------------------|--|
| | |
| Verification | Displays the address filtering table of IP Source Guard. |
| | <pre>Ruijie# show ip verify source</pre> |

➤ **Configuring a Static Binding**

| | |
|----------------------------|---|
| Configuration Steps | <ul style="list-style-type: none"> ● Enable DHCP Snooping. ● Enable IP Source Guard. ● Configure a static binding. |
| | <pre>Ruijie# configure terminal Ruijie(config)# ip source binding 00d0.f801.0101 vlan 1 192.168.4.243 interface GigabitEthernet 0/3 Ruijie(config)# end</pre> |
| Verification | Displays the address filtering table of IP Source Guard. |
| | <pre>Ruijie# show ip verify source NO. INTERFACE FilterType FilterStatus IPADDRESS MACADDRESS VLAN TYPE ----- ----- 1 GigabitEthernet 0/3 UNSET Inactive-restrict-off 192.168.4.243 00d0.f801.0101 1 Static 2 GigabitEthernet 0/1 IP-ONLY Active Deny-All 3 WLAN 1 IP-MAC Active Deny-All</pre> |

➤ **Configuring a Static Binding of a QINQ-Termination Product**

| | |
|----------------------------|---|
| Configuration Steps | <ul style="list-style-type: none"> ● Enable DHCP Snooping. ● Enable IP Source Guard. ● Configure a static binding. |
| | <pre>Ruijie# configure terminal Ruijie(config)# ip source binding 00d0.f801.0101 vlan 1 inner-vlan 10 192.168.4.243 interface GigabitEthernet 0/3 Ruijie(config)# end</pre> |
| Verification | Displays the address filtering table of IP Source Guard. |
| | <pre>Ruijie# show ip verify source NO. INTERFACE FILTERTYPE FILTERSTATUS IPADDRESS MACADDRESS</pre> |

| | |
|----------------------------|---|
| Configuration Steps | <ul style="list-style-type: none"> ● Enable DHCP Snooping. ● Enable IP Source Guard. ● Configure a static binding. |
| | <pre>Ruijie# configure terminal Ruijie(config)# ip source binding 00d0.f801.0101 vlan 1 inner-vlan 10 192.168.4.243 interface GigabitEthernet 0/3 Ruijie(config)# end</pre> |
| | |
| Verification | Displays the address filtering table of IP Source Guard. |
| | <pre>VLAN INNER-VLAN TYPE ----- 1 GigabitEthernet 0/3 UNSET Inactive-restrict-off 192.168.4.243 00d0.f801.0101 1 10 Static</pre> |

↘ Specifying an Excluded VLAN

| | |
|----------------------------|--|
| Configuration Steps | <ul style="list-style-type: none"> ● Enable DHCP Snooping. ● Enable IP Source Guard. |
| | <pre>Ruijie(config)# interface GigabitEthernet 0/1 Ruijie(config-if-GigabitEthernet 0/1)# ip verify source Ruijie(config-if-GigabitEthernet 0/1)# ip verify source exclude-vlan 1 Ruijie(config-if)# end Ruijie(config)# wlansec 1 Ruijie(config-wlansec)# ip verify source Ruijie(config-wlansec)# ip verify source exclude-vlan 1 Ruijie(config-wlansec)# end</pre> |
| | |
| Verification | Display the configuration of excluded VLANs specified on a port. |
| | <pre>Ruijie# show run</pre> |

Common Errors

- Enable IP Source Guard on a trusted port under DHCP Snooping.
- Specify an excluded VLAN before IP Source Guard is enabled.

9.5 Monitoring

Displaying

| Description | Command |
|---|--|
| Displays the address filtering table of IP Source Guard. | show ip verify source [interface <i>interface-id</i> wlan <i>wlan-id</i>] |
| Displays the address binding database of IP Source Guard. | show ip source binding |

10 Configuring DNS SNOOPING

10.1 Overview

DNS SNOOPING snoops the domain name server (DNS) packets exchanged between clients and servers to record the mapping table entries of domain names and IP addresses. It can also filter invalid DNS packets, including request packets from clients and response packets from servers.

DNS SNOOPING supports the following function:

Settings of authentication-free uniform resource locators (URLs), that is, domain name-based direct-through addresses.

Protocols and Standards

- RFC1034: DOMAIN NAMES - CONCEPTS AND FACILITIES
- RFC1035: DOMAIN NAMES - IMPLEMENTATION AND SPECIFICATION

10.2 Applications

| Application | Description |
|--|--|
| Applying Authentication-free URL | Unauthenticated clients cannot access the network normally when the Web-based authentication function is enabled on the AC. With the authentication-free URL function enabled, clients are allowed to access specific URLs without authentication. |

10.2.1 Applying Authentication-free URL

Scenario

As shown in Figure 11-1, the AC interacts with the MCP server, to implement the control on the network access right of unauthenticated downlink clients as well as their authentication via the authentication over WeChat following function.

Unauthenticated clients can access only WeChat, and can pass authentication by following the WeChat public account.

Authenticated clients have unrestricted network access rights.

Figure 10-1

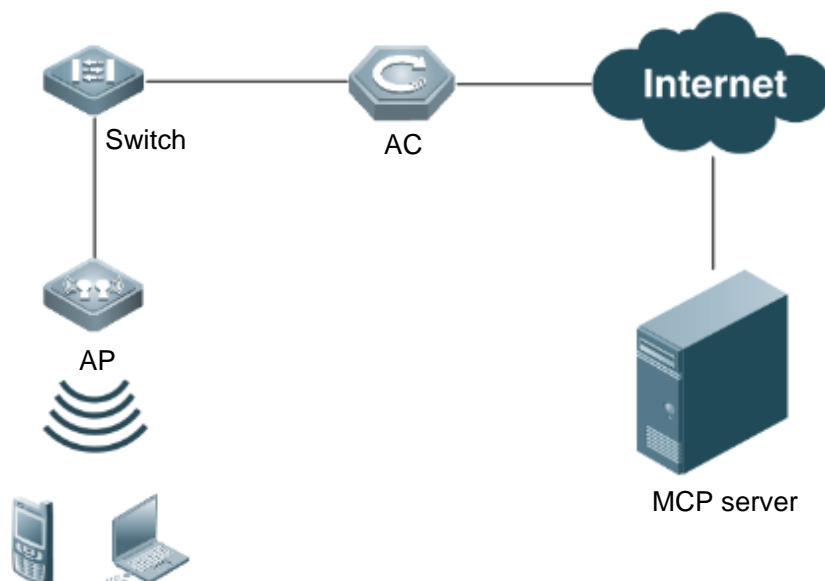

| | |
|-----------------|---|
| Remarks: | <p>Switch indicates a switch.</p> <p>AC indicates an access controller.</p> <p>AP indicates a wireless access point.</p> <p>MCP server is a cloud server.</p> |
|-----------------|---|

Deployment

- Enable the authentication over WeChat following function on the AC for interaction with the MCP server.

10.3 Features

Basic Concepts

Authentication-free App

Unauthenticated clients can access authentication-free Apps, such as WeChat and Sina Weibo.

Authentication-free URL

Unauthenticated clients cannot access the network normally when the Web-based authentication function is enabled on the AC. With the authentication-free URL function enabled, clients are allowed to access specific URLs without authentication.

CWMP

CPE WAN Management Protocol (CWMP) is a technical standard initiated by Digital Subscriber's Line (DSL) forum and numbered TR-069. Therefore, CWMP is also known as TR-069 protocol. It provides the universal framework, message specification, method and data model for managing and configuring home network devices in next-generation networks.

The implementation of TR-069 protocol is complex. For App authentication, TR-069 provides the network channel for communication between the AC and the MCP server.

Overview

| Feature | Description |
|---|--|
| Authentication-free URL | Unauthenticated clients cannot access the network normally when the Web-based authentication function is enabled on the AC. With the authentication-free URL function enabled, clients are allowed to access specific URLs without authentication. |

10.3.1 Authentication-free URL

After the authentication-free URL function is enabled on the AC, unauthenticated clients are allowed to access specific URLs.

Working Principle

Unauthenticated clients cannot access the network normally when the Web-based authentication function is enabled on the AC. With the authentication-free URL function enabled, if the AC determines that traffic of an unauthenticated client contains the URL characteristics, the AC allows the traffic to pass and the client can access the specific URL without authentication.

10.4 Configuration

| Configuration | Description and Command |
|--|--|
| Configuring authentication-free URL. |  (Mandatory) It is used to configure authentication-free Apps in global configuration mode. |
| | free-url Configures the authentication-free URL. At present, only WeChat, Sina App, certain iPhone Apps, and designated URLs are supported. |
| | ip dns snooping enable Enables DNS SNOOPING. |

10.4.1 Configuring Authentication-free URL

Configuration Effect

- Allow unauthenticated clients to access the configured authentication-free URL directly.

Notes

- The authentication-free URL takes effect only after the Web-based authentication function is enabled.

Configuration Steps

📌 Enabling DNS SNOOPING

- Mandatory.
- Enable DNS SNOOPING on the device.

| | |
|------------------------------|--|
| Command | ip dns snooping enable |
| Parameter Description | N/A |
| Defaults | DNS SNOOPING is enabled by default. |
| Command Mode | Global configuration mode |
| Usage Guide | Run this command to enable DNS SNOOPING. |

↘ Configuring Authentication-free URL

- Mandatory.
- Configure an authentication-free URL on the AC.

| | |
|------------------------------|--|
| Command | free-url { weixin sina iphone url url } |
| Parameter Description | weixin: Indicates WeChat. sina: Indicates a Sina App. iphone: Indicates an iPhone App. url: Indicates a designated URL. |
| Defaults | No authentication-free URL is configured by default. |
| Command Mode | Global configuration mode |
| Usage Guide | You can configure multiple authentication-free URLs. |

Verification

- Run the **show free-url** command to check the configuration status.
- Check whether unauthenticated clients can access the authentication-free URLs directly when the Web-based authentication function is enabled on the AC.

Configuration Example

↘ Configuring WeChat as Authentication-free URL on AC

| | |
|----------------------------|--|
| Configuration Steps | <ul style="list-style-type: none"> ● Enter the global configuration mode. ● Configure WeChat as an authentication-free URL. |
| Device | <pre>Ruijie#configure terminal Enter configuration commands, one per line. End with CNTL/Z. Ruijie(config)#ip dns snooping enable Ruijie(config)# free-url weixin Ruijie(config)# free-url *.baidu.com Ruijie(config)#exit</pre> |

| | |
|---------------------|---|
| Verification | Run the show free-url command to check the authentication-free URL information. |
| Device | <pre> Ruijie(config)#show free-url Total number of domain name : 4 Total number of ip address : 11 ===== free-url domain name table ===== Host type *.qpic.cn weixin *.weixin.qq.com weixin weixin.qq.com weixin *.baidu.com url ===== ===== free-url ip table ===== Host type Address TTL(sec) *.weixin.qq.com weixin 61.151.224.41 2118 140.207.135.125 2118 140.207.54.47 2118 *.qpic.cn weixin 140.206.160.234 2118 183.61.49.180 151 101.226.129.204 554 14.17.52.136 16 weixin.qq.com weixin 14.17.42.45 800 *.baidu.com url 115.239.210.246 19 115.239.211.235 2286 115.239.210.14 284 </pre> |

10.5 Monitoring

Clearing

Displaying

| Description | Command |
|------------------------------------|-----------------------|
| Displays authentication-free URLs. | show free-url |
| Clears authentication-free URLs. | clear free-url |

Debugging

 System resources are occupied when debugging information is output. Therefore, disable the debugging switch immediately after use.

| Description | Command |
|----------------------|---------------------------|
| Debugs DNS SNOOPING. | debug dns-snooping |

11 Configuring IGMP Snooping

11.1 Overview

Internet Group Management Protocol (IGMP) snooping is a mechanism of listening to IP multicast. It is used to manage and control the forwarding of IP multicast traffic within VLANs, realizing Layer-2 multicasting.

As shown in the following figure, when a Layer-2 device is not running IGMP snooping, IP multicast packets are broadcasted within the VLAN; when the Layer-2 device is running IGMP snooping, IP multicast packets are transmitted only to profile members.

Figure 11-1 Networking Topology of IP Multicast Forwarding within the VLAN Before and After IGMP Snooping Is Run on the Layer-2 Device

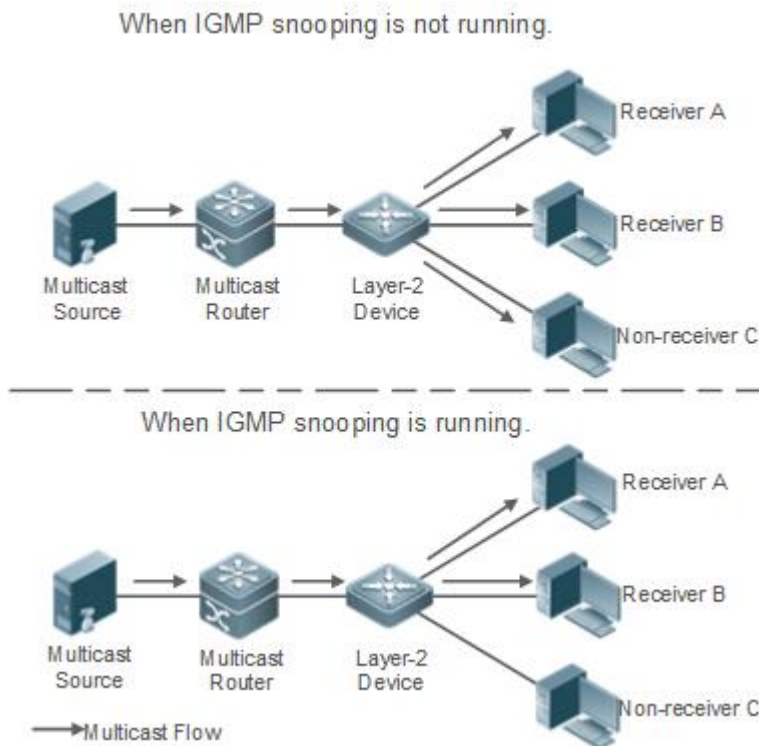

As shown in the following figure, when IGMP Snooping does not run on the AC and AP in wireless multicast environment, multicast packets are broadcasted within the VLAN of the AC and are broadcasted by the AP to all wireless ports. When IGMP Snooping runs on both the AC and AP, multicast packets of a known multicast profile are not broadcasted but forwarded to specific receivers.

Figure 11-2 Forwarding of IP Multicast Streams in a VLAN Before and After IGMP Snooping Is Enabled on the AC and AP

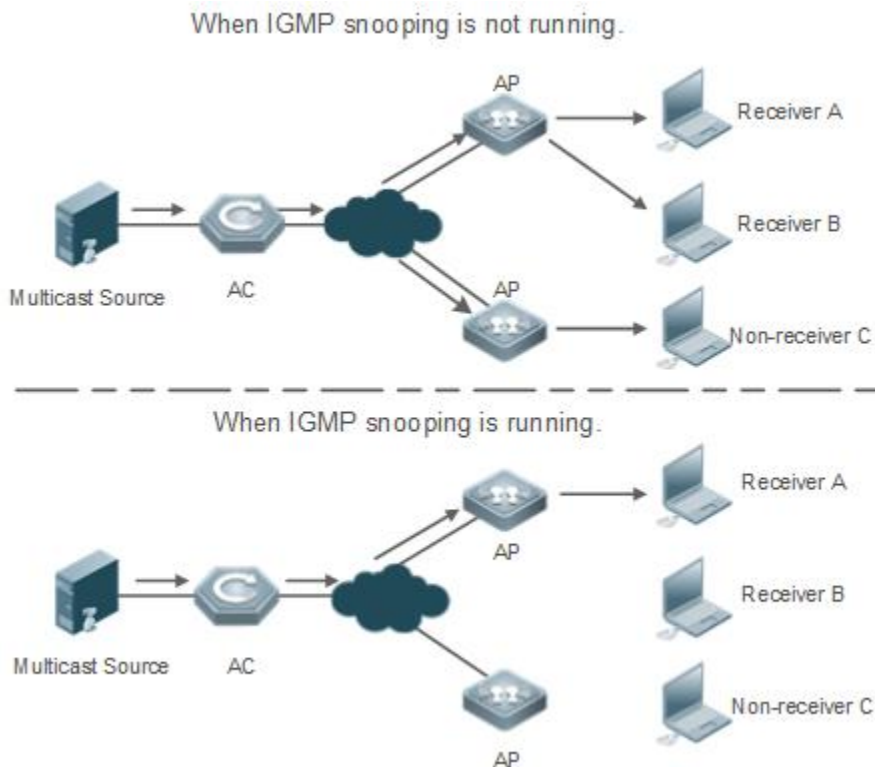

Protocols and Standards

- RFC4541: Considerations for Internet Group Management Protocol (IGMP) and Multicast Listener Discovery (MLD) Snooping Switches

11.2 Applications

| Application | Description |
|---|--|
| Layer-2 Multicast Control | Enables precise forwarding of Layer-2 multicast packets to avoid flooding at this layer. |
| Multicast-to-Unicast Conversion | Implements transmission of multicast packets between the AP and STAs in unicast mode. |

11.2.1 Layer-2 Multicast Control

Scenario

- As shown in the following figure, multicast packets are transmitted to users through a Layer-2 switch. When Layer-2 multicast control is not performed, namely, when IGMP snooping is not implemented, multicast packets are flooded to all the users including those who are not expected to receive these packets. After IGMP snooping is implemented, the multicast packets from an IP multicast profile will no longer be broadcast within the VLAN but transmitted to designated receivers.
- Figure 11-3 Networking Topology of Implementing Layer-2 Multicast Control (Multicast VLAN)

When IGMP snooping is not running.

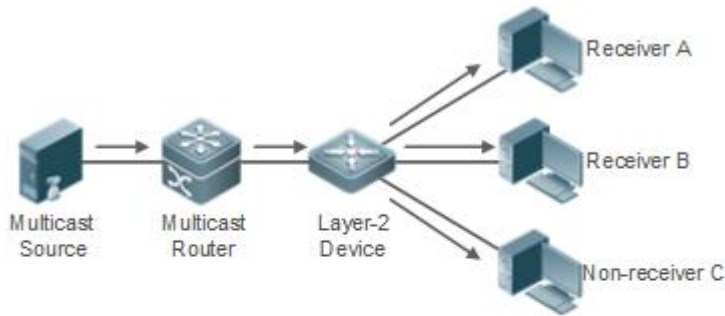

When IGMP snooping is running.

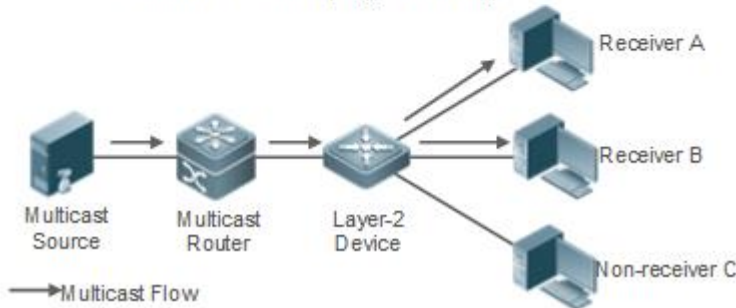

Deployment

- Configure basic IGMP snooping functions.

11.2.2 Multicast-to-Unicast Conversion

Scenario

- When multicast-to-unicast conversion is not configured, packets are transmitted from the AP to STAs in multicast mode. There is no acknowledgement and retransmission mechanism for multicast packets in wireless networks. As a result, severe packet loss occurs, which affect experience of wireless multicast services in video on demand and other applications. Wireless multicast packets between the AP and STAs can be configured to be transmitted in multicast-to-unicast conversion mode in order to reduce the packet loss rate and enhance user experience.
- Figure 11-4 Multicast-to-Unicast Conversion

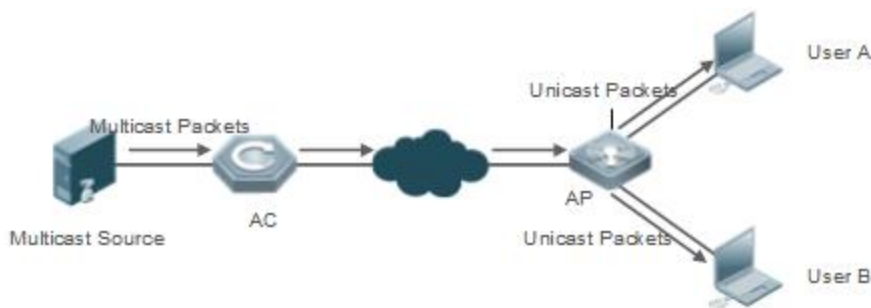

Deployment

- Configure the multicast-to-unicast conversion function.
-
- **i** The function is available only in wireless multicast scenarios.
-

11.3 Features

Basic Concepts

➤ Multicast Router Ports and Member Ports

- **i** IGMP snooping is VLAN-based. The ports involved refer to the member ports within the VLAN.

The device running IGMP snooping identifies the ports within the VLAN as a multicast router port or member port so as to manage and control the forwarding of IP multicast traffic within the VLAN. As shown in the following figure, when IGMP snooping is run on a Layer-2 device, multicast traffic enters the multicast router port and exits from the member ports.

Figure 11-5 Networking Topology of Two IGMP Snooping Ports

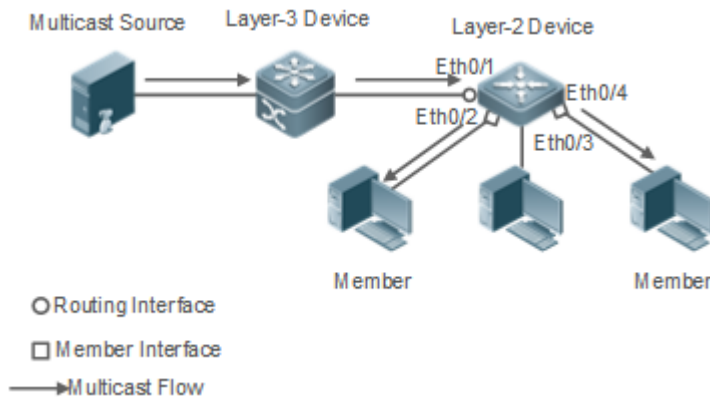

- Multicast router port: The location of the multicast source is directed by the port on the Layer-2 multicast device which is connected to the multicast router (Layer-3 multicast device): By listening to IGMP packets, the Layer-2 multicast device can automatically detect the multicast router port and maintain the port dynamically. It also allows users to configure a static router port.
- Member port: The port is on a Layer-2 multicast device and is connected to member hosts. It directs the profile members. It is also called the Listener Port. By listening to IGMP packets, the Layer-2 multicast device can automatically detect the member port and maintain the port dynamically. It also allows users to configure a static member port.
- Figure 11-6 Two Types of Ports in Wireless Environment

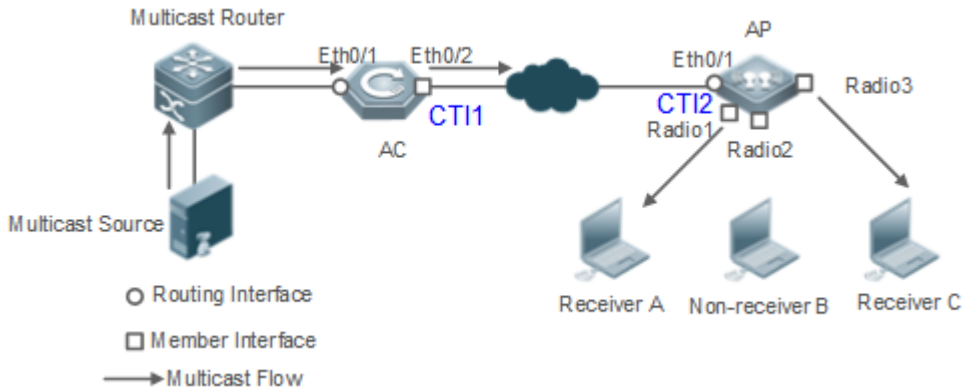

- Multicast router port: When the AC receives the PIM Hello or IGMP Query packet from the upstream multicast router (Layer-3 multicast device), the multicast router port Eth0/1 forms. When the AP receives the PIM Hello or IGMP Query packet forwarded by the AC, the multicast router port CT12 also forms.
- Member port: also called listener port, that is, the port on a device for connecting to a multicast member. When Ports Radio1 and Radio3 on the AP receive Report packets from a wireless user receiver, they learn the wireless port as a member port. When the virtual interface CT11 receives Report packets forwarded by the AP, it also learns the relevant wireless port as a member port.

IGMP Snooping Forwarding Entry

The device running IGMP snooping forwards IP multicast packets in accordance with the IGMP snooping forwarding entry. An IGMP snooping forwarding entry includes the following items: source address (S), profile address (G), VLAN ID (VLAN_ID), multicast router port, and member port. It indicates that packets of required features (including S, G, and VLAN_ID) should enter the multicast router port and exit from a member port. An IGMP snooping forwarding entry is identified using a group of S, G, and VLAN_ID.

To display the IGMP snooping forwarding entry, run the **show ip igmp snooping gda-table** command.

```
Ruijie# show ip igmp snooping gda-table
Multicast Switching Cache Table
D: DYNAMIC //Dynamic member port
S: STATIC //Static member port
M: MROUTE //Multicast router port (dynamic or static)
(*, 233.3.6.29, 1): //(S: any; G: 233.3.6.29; VLAN_ID: VLAN 1)
VLAN(1) 3 OPORTS:
GigabitEthernet 0/3(S)
GigabitEthernet 0/2(M)
GigabitEthernet 0/1(D)
capwap-Tunnel 0/1(D) // CAPWAP tunnel
(*, 233.3.6.30, 1): //S: any; G: 233.3.6.30; VLAN_ID: VLAN 1)
VLAN(1) 2 OPORTS:
GigabitEthernet 0/2(M)
GigabitEthernet 0/1(D)
```



```
(*,239.1.1.1, 1): //(any source address, with the group address of 239.1.1.1 and VLAN ID of 1)
VLAN(1) 1 OPORTS:
    dot11radio 1/0.1 (D) //wireless interface
```

Overview

| Feature | Description |
|---|--|
| Listening to IGMP Packets | Discovers and identifies the router port and member port to establish and maintain the IGMP snooping forwarding entries. : |
| IGMP Snooping Working Modes | Provides independent or shared multicast services to the user VLAN. |
| IGMP Querier | On a network without a Layer-3 multicast device, the Layer-2 multicast device acts as an IGMP querier. |
| Configuring Multicast-to-Unicast Conversion | Implements transmission of multicast packets between the AP and STAs in unicast mode. |
| Optimizing Multicast Wireless Environment Configuration | Ignores port timer resetting for query packets. |

11.3.1 Listening to IGMP Packets

A device running IGMP snooping analyzes IGMP packets received, and finds and identifies the router port and member port using these packets, thereby creating and maintaining an IGMP snooping entry.

Working Principle

A device running IGMP snooping can identify and handle the following types of IGMP packets:

Query Packets

- i** An IGMP querier periodically sends General Query packets. When the IGMP querier receives Leave packets, it sends Group-Specific Query packets.

When the device running IGMP snooping receives the Query packets, it performs the following operations within the VLAN:

- Forward the IGMP Query packets to all the ports (except the receiving port of these packets).
- If the receiving port is a dynamic router port, reset the aging timer. If the timer expires, the port will no longer be used as the dynamic router port.
- If the receiving port is not a dynamic router port, use it as a dynamic router port and enable the aging timer. If the timer expires, the port will no longer be used as the dynamic router port.
- For general queries, reset the aging timer for all the dynamic member ports. If the timer expires, the port will no longer be used as the dynamic member port for the general group. By default, the maximum response time carried by the

IGMP query packets is used as the timeout time of the aging timer. If **ip igmp snooping query-max-response-time** is run, the time displayed is used as the timeout time of the aging timer.

- For designated query packets, reset the aging timer for all the dynamic member ports of the designated profile. If the timer expires, the port will no longer be used as the dynamic member port of the designated profile. By default, the maximum response time carried by the IGMP query packets is used as the timeout time of the aging timer. If **ip igmp snooping query-max-response-time** is run, the time displayed is used as the timeout time of the aging timer.
- If dynamic router port learning is disabled, IGMP snooping will not learn the dynamic router port.

Report Packets

- i** When a member host receives a query, it responds to the query with a Report packet. If a host requests to join a profile, it will also send a report.
- i** By default, IGMP Snooping is capable of processing IGMPv1 and IGMPv2 packets. For IGMPv3 Report packets, it processes profile information but does not process carried source information. IGMP Snooping v3 can be configured to process all information in IGMPv1, IGMPv2, and IGMPv3 packets.

When the device running IGMP snooping receives the Report packets, it performs the following operations within the VLAN:

- Forward the Report packets from all the router ports. After the **ip igmp snooping suppression enable** command is run in one IGMP query cycle, only the first report received by each profile will be forwarded.
- If the port on which Report packets are received is a dynamic member port, reset the aging timer. If the timer expires, the port will no longer be used as the dynamic member port of the designated profile.
- If the port on which Report packets are received is not a dynamic member port, use it as a dynamic member port and enable the aging timer. If the timer expires, the port will no longer be used as the dynamic member port of the designated profile.

Leave Packets

- i** If a host requests to leave a profile, it will send a Leave packet.

When the device running IGMP snooping receives the Leave packets, it performs the following operations within the VLAN:

- Forward the leave packets from all the router ports.
- If the port on which leave packets are received is a dynamic member port and the Leave function is enabled, the port will be immediately deleted from the IGMP snooping forwarding entry of the designated profile and will no longer be used as the dynamic member port.
- If the port on which the leave packets are received is a dynamic member port and the Leave function is disabled, the port state should be maintained.

Related Configuration

Configuring a Static Router Port

Run the **ip igmp snooping vlan mrouter interface** command to configure a static router port.

↘ **Configuring a Static Member Port**

Run the **ip igmp snooping vlan static interface** command to configure a static member port.

↘ **Enabling Report Suppression**

Report suppression is disabled by default.

Run the **ip igmp snooping suppression enable** command to enable report suppression.

After report suppression is enabled, in one IGMP query cycle, only the first Report packet received by each profile will be forwarded. The source media access control (MAC) address of the forwarded report will be changed to the MAC address of the device.

↘ **Enabling Immediate Leave**

Immediate leave is disabled by default.

Run the **ip igmp snooping fast-leave enable** command to enable immediate leave.

↘ **Enabling Dynamic Router Port Learning**

Dynamic router port learning is enabled by default.

Run the **no ip igmp snooping mrouter learn pim-dvmrp** command to disable dynamic router port learning.

Run the **no ip igmp snooping vlan vid mrouter learn pim-dvmrp** command to disable dynamic router port learning for designated VLANs.

↘ **Configuring the Aging Time of a Dynamic Router Port**

The default aging time is 300s.

When a dynamic router port receives a query packet, the aging timer of the port is enabled or reset; if the aging time is not configured, the maximum response time carried by the query packet is used as the aging time.

Run **ip igmp snooping dyn-mr-aging-time** to configure the aging time of the dynamic router port.

↘ **Configuring the Aging Time of a Dynamic Member Port**

The default aging time is 260s.

When a dynamic member port receives a query packet, the aging timer of the port is enabled or reset, and the aging time is the maximum response time carried by the query packet.

When a dynamic member port receives a Report packet, the aging timer of the port is enabled or reset, and the aging time is the maximum response time of the dynamic member port.

Run **ip igmp snooping host-aging-time** to configure the aging time of the dynamic member port.

↘ **Configuring the Maximum Response Time of a Query Packet**

The maximum response time of a query packet is not configured by default and the maximum response time carries by the query packet is used.

Run **ip igmp snooping query-max-response-time** to configure the maximum response time of a query packet.

11.3.2 IGMP Snooping Working Modes

A device running in the IVGL mode of IGMP snooping can provide independent multicast services to the user VLAN.

Working Principle

↘ IVGL

In IVGL mode, a device running IGMP snooping can provide independent multicast services to each user VLAN.

Independent multicast services indicate that multicast traffic can be forwarded only within the VLAN it belongs to, and a user host can subscribe to the multicast traffic within the VLAN that the host belongs to.

Related Configuration

↘ Enabling IGMP Snooping and Selecting a Working Mode

IGMP snooping is disabled by default.

Run the **ip igmp snooping** command to enable IGMP snooping in IVGL mode.

11.3.3 IGMP Querier

On a network with a Layer-3 multicast device, the Layer-3 multicast device acts as an IGMP querier. In this case, a Layer-2 device needs only to listen to IGMP packets to establish and maintain the forwarding entry, realizing Layer-2 multicast.

On a network without a Layer-3 multicast device, the Layer-2 multicast device must be configured with the IGMP querier function so that the device can listen to IGMP packets. In this case, a Layer-2 device needs to act as an IGMP querier as well as listen to IGMP packets to establish and maintain the forwarding entry to realize Layer-2 multicast.

Working Principle

A Layer-2 device acts as an IGMP querier to periodically send IGMP Query packets, listen to and maintain the IGMP Report packets replied by a user, and create a Layer-2 multicast forwarding entry. You can adjust relevant parameters of the Query packets sent by the IGMP querier through configuration.

When the device receives a Protocol-Independent Multicast (PIM) or Distance Vector Multicast Routing Protocol (DVMRP) packet, it considers that a multicast router, which will act as an IGMP querier, exists on the network and disables the querier function. In this way, IGMP routing will not be affected.

When the device receives the IGMP Query packets from other devices, it will compete with other devices for the IGMP querier.

↘ Enabling the Querier Function

You can enable the querier for a specific VLAN or all VLANs.

Only when the global querier function is enabled can the queriers for specific VLANs take effect.

↘ Specifying the IGMP Version for a Querier

The version of IGMP used for sending Query packets can be configured as IGMPv1, IGMPv2, or IGMPv3.

↘ **Configuring the Source IP Address of a Querier**

You can configure the source IP address of a query packet sent by the querier based on VLANs.

When the source IP address of the querier is not configured, the querier will not take effect.

↘ **Configuring the Query Interval of a Querier**

You can configure the intervals for sending global Query packets based on different queriers on different VLANs.

↘ **Configuring the Maximum Response Time of a Query Packet**

You can configure the maximum response time carried by a Query packet that is sent by a querier. As IGMPv1 does not support the carrying of maximum response time by a Query packet, this configuration does not take effect when the querier is running IGMPv1. You can configure different maximum response time for queriers on different VLANs.

↘ **Configuring the Aging Time of a Querier**

When other IGMP queriers exist on a network, the existing device will compete with other queriers. If the existing device fails to be elected and is in the non-querier state, the aging timer of a querier will be enabled. After the timer expires, other queriers on the network are considered as expired and the existing device will be resumed as the querier.

Related Configuration

↘ **Enabling the Querier Function**

By default, the querier function of a device is disabled.

Run the **ip igmp snooping querier** command to enable the global querier function.

Run the **ip igmp snooping vlan num querier** command to enable the querier function for specific VLANs.

↘ **Specifying the IGMP Version for a Querier**

By default, a querier runs IGMPv2.

Run the **ip igmp snooping querier version** command to configure the global querier version.

Run the **ip igmp snooping vlan querier version** command to specify the querier version for specific VLANs.

↘ **Configuring the Source IP Address of a Querier**

By default, the source IP address of a querier is 0.

Run the **ip igmp snooping querier address** command to enable global source IP addresses of queriers.

Run the **ip igmp snooping vlan querier address** command to specify the source IP addresses of the queriers on specific VLANs.

↘ **Configuring the Query Interval of a Querier**

By default, the query interval of a querier is 60s.

Run the **ip igmp snooping querier query-interval** command to enable the global query interval of queriers.

Run **ip igmp snooping vlan querier query-interval** to specify the global query interval of the queriers on specific VLANs.

↘ **Configuring the Maximum Response Time of a Query Packet**

By default, the maximum response time of a query packet is 10s.

Run the **ip igmp snooping querier max-response-time** command to configure the maximum response time of the query packets sent by global queriers.

Run the **ip igmp snooping vlan querier max-response-time** command to specify the maximum response time of the query packets sent by the queriers on specific VLANs.

↘ **Configuring the Aging Time of a Querier**

By default, the aging time of a querier is 125s.

Run the **ip igmp snooping querier max-response-time** command to configure the aging time of global queriers.

Run the **ip igmp snooping vlan querier max-response-time** command to configure the aging time of queriers on specific VLANs.

11.3.4 Multicast-to-Unicast Conversion

The multicast-to-unicast conversion function is available only in wireless environment. After the function is configured on a wireless device, multicast packets between an AP and STAs are transmitted in unicast mode. The multicast-to-unicast conversion function runs on the AP.

Working Principle

The following describes the working principle of multicast-to-unicast conversion from several scenarios in wireless environment.

In fat AP mode, IGMP Snooping needs to learn and track user information. After multicast-to-unicast conversion is configured, the wireless multicast fast forwarding module queries the users who need multicast-to-unicast conversion through the interface provided by the multicast-to-unicast conversion module, and replaces the destination MAC addresses in multicast packets of the users with the MAC addresses of STAs, and destination IP addresses with IP addresses of the STAs, and then forwards the multicast packets in unicast mode.

In fit AP centralized forwarding mode, an AC, according to recorded user information, queries the WLAN ID and RADIO ID of an STA for packets, conducts CAPWAP encapsulation on the packets, and then sends the packets to an AP. If the multicast-to-unicast conversion is enabled, packets sent to the AP are delivered to the wireless multicast fast forwarding module, which queries the interface of the multicast-to-unicast conversion module to learn about the users who need multicast-to-unicast conversion. Then, the AP transmits multicast packets in unicast mode.

In fit AP local forwarding mode, after packets are forwarded to an AP, if multicast-to-unicast conversion is enabled, the AP delivers the packets to the wireless multicast fast forwarding module, which transmit multicasts the packets in unicast mode.

Related Configuration

↘ **Enabling the Global Multicast Function**

By default, the global multicast function is disabled. Run the **ip multicast wlan** command to enable the global multicast function. After global multicast is enabled, when an AC receives multicast packets, it conducts CAPWAP encapsulation on the multicast packets and sends the packets to the AP associated with the AC in CAPWAP unicast mode.

Run the **no ip multicast wlan** command to restore default configuration. After global multicast is disabled, an AC directly discards the received multicast packets.

↘ Enabling Multicast-to-Unicast Conversion

By default, multicast-to-unicast conversion is disabled.

In ap-config mode on an AC, run the **igmp snooping mcast-to-unicast enable** command to enable multicast-to-unicast conversion, or on a fat AP, run the **ip igmp snooping mcast-to-unicast enable** command to enable multicast-to-unicast conversion.

In ap-config mode on an AC, run the **no igmp snooping mcast-to-unicast enable** command to disable multicast-to-unicast conversion, or on a fat AP, run the **no ip igmp snooping mcast-to-unicast enable** command to disable multicast-to-unicast conversion.

↘ Configuring the Multicast Range for Multicast-to-Unicast Conversion

By default, multicast-to-unicast conversion is available to all multicast profiles.

Use AC as an example. In ap-config mode, run the **igmp snooping mcast-to-unicast group-range** command to configure the profile address range for multicast-to-unicast conversion.

In ap-config mode, run the **no igmp snooping mcast-to-unicast group-range** command to restore the default configuration.

↘ Configuring the Maximum Number of Profiles That Are Allowed to Use Multicast-to-Unicast Conversion

By default, multicast-to-unicast conversion can be configured for a maximum of 64 multicast profiles.

Use AC as an example. In ap-config mode, run the **igmp snooping mcast-to-unicast max-group** command to configure the maximum number of multicast profiles that are allowed to use multicast-to-unicast conversion.

In ap-config mode, run the **no igmp snooping mcast-to-unicast max-group** command to restore the default configuration.

11.3.5 Optimizing the Multicast Wireless Environment Configuration

Ignoring port timer resetting for query packets refers to not resetting the port aging timer when a device receives query packets.

When multiple STAs are configured in a congested wireless network, after an AP sends out a query packet, the IGMP report packet responded by STAs may be discarded or the STAs fail to receive the query packet, and as a result, the AP fails to receive responses from the STAs. Traffic interruption may occur on the STAs. In this case, this function can be configured, in combination with aging time configuration of member ports, to ensure that an STA does not age within multiple query intervals. If an IGMP report packet from the STA is received within the query intervals, the port timer time is reset as the port aging time.



The configuration takes effect when query packets are received next time. A port timer that has been reset on a port will not be cancelled. The configuration prolongs aging time. Use it in appropriate scenarios.

The function is disabled by default.

Use AC as an example. In ap-config mode, run the **igmp snooping ignore-query-timer** command to ignore the port aging timer resetting for query packets.

In ap-config mode, run the **no igmp snooping ignore-query-timer** command to restore the default configuration.

11.4 Configuration

| Configuration | Description and Command | |
|---|--|---|
| Configuring Basic IGMP Snooping Functions (IVGL Mode) |  Any of IVGL mode, SVGL mode, and IVGL-SVGL mode must be selected. It is used to enable IGMP snooping in IVGL mode. | |
| | ip multicast wlan | Enables global multicast. |
| | ip igmp snooping | Enables global IGMP snooping on a Fat AP. |
| | igmp snooping | Enables global IGMP snooping on an AC. |
| | no ip igmp snooping vlan num | Disables IGMP snooping for a VLAN. |
| Configuring the Packet Processing |  (Optional) It is used to adjust relevant configurations for processing protocol packets. | |
| | ip igmp snooping vlan vlan-id mrouter interface interface-id | Configures a static router port. |
| | p igmp snooping vlan vid static group-address interface interface-type interface-number | Configures a static member port. |
| | ip igmp snooping vlan vlan-id mrouter learn pim-dvmrp | Enables dynamic router port learning. |
| | ip igmp snooping host-aging-time time | Configures the aging time of a dynamic member port on an AC. |
| | igmp snooping host-aging-time time | Configures the aging time of a dynamic member port on a Fat AP. |
| | ip igmp snooping fast-leave enable | Enables the immediate-leave function for a dynamic member port. |
| | igmp snooping query-max-response-time time | Configures the maximum response time of an IGMP query packet on an AC. |
| | ip igmp snooping query-max-response-time time | Configures the maximum response time of an IGMP query packet on a Fat AP. |
| ip igmp snooping suppression enable | Enables IGMP Report packet suppression. | |

| | | |
|---|--|---|
| Configuring an IGMP Querier |  (Optional) It is used to enable IGMP querier function on a network without a Layer-3 multicast device. | |
| | ip igmp snooping querier | Enables global querier function. |
| | ip igmp snooping vlan <i>num</i> querier | Enables the querier for a VLAN. |
| | ip igmp snooping querier version <i>num</i> | Specifies the IGMP version for queriers globally. |
| | ip igmp snooping vlan <i>num</i> querier version <i>num</i> | Specifies the IGMP version for a querier of a VLAN. |
| | ip igmp snooping querier address a.b.c.d | Configures the source IP address of queriers globally. |
| | ip igmp snooping vlan <i>num</i> querier address a.b.c.d | Configures the source IP address for a querier of a VLAN. |
| | ip igmp snooping querier query-interval <i>num</i> | Configures the query interval of queriers globally. |
| | ip igmp snooping vlan <i>num</i> querier query-interval <i>num</i> | Configures the query interval for a querier of a VLAN. |
| | ip igmp snooping querier max-response-time <i>num</i> | Configures the maximum response time for query packets globally. |
| | ip igmp snooping vlan <i>num</i> querier max-response-time <i>num</i> | Configures the maximum response time of query packets for a VLAN. |
| ip igmp snooping querier timer expiry <i>num</i> | Configures the aging timer for queriers globally. | |
| ip igmp snooping vlan <i>num</i> querier timer expiry <i>num</i> | Configures the aging timer for a querier of a VLAN. | |
| Configuring Multicast-to-Unicast Conversion | igmp snooping mcast-to-unicast enable | Enables multicast-to-unicast conversion on an AC. |
| | ip igmp snooping mcast-to-unicast enable | Enables multicast-to-unicast conversion on an Fat AP. |
| | igmp snooping mcast-to-unicast group-range <i>ip-addr ip-addr</i> | Configures an AP's maximum multicast range for multicast-to-unicast conversion on an AC. |
| | ip igmp snooping mcast-to-unicast group-range <i>ip-addr ip-addr</i> | Configures an AP's maximum multicast range for multicast-to-unicast conversion on a Fat AP. |
| | igmp snooping mcast-to-unicast max-group <i>group-num</i> | Configures an AP's maximum number of multicast profiles that are allowed to use multicast-to-unicast conversion on an AC. |

| | | |
|---|---|--|
| | ip igmp snooping mcast-to-unicast max-group <i>group-num</i> | Configures an AP's maximum number of multicast profiles that are allowed to use multicast-to-unicast conversion on a Fat AP. |
| Optimizing the Wireless Multicast Environment | igmp snooping ignore-query-timer | Configures the function of ignoring port aging timer resetting for query packets on n AC. |
| | ip igmp snooping ignore-query-timer | Configures the function of ignoring port aging timer resetting for query packets on a Fat AP. |

11.4.1 Configuring Basic IGMP Snooping Functions (IVGL Mode)

Configuration Effect

- Enable IGMP snooping to realize Layer-2 multicast.
- Provide independent multicast services to each VLAN.

Configuration Steps

▾ Enabling Global Multicast

Mandatory.

After global multicast is enabled, IGMP snooping can be enabled.

▾ Enabling Global IGMP Snooping in IVGL Mode

Mandatory.

After IGMP snooping is enabled globally, this function will be enabled for all VLANs.

▾ Enabling Multicast of AP

Mandatory.

To enable multicast of AP, run the **igmp snooping** command in AP configuration mode of AC.

▾ Disabling IGMP Snooping for a VLAN

(Optional) You can use this function if you wish to disable IGMP snooping on specified VLANs.

Only when global IGMP snooping is enabled can it be disabled on specified VLANs.

In IVGL mode, each VLAN can enjoy independent multicast services. Disabling any VLAN multicast services will not interfere in the services provided to the others.

Verification

- Run the **show ip igmp snooping gda-table** command to display the IGMP snooping forwarding table and verify that the member ports include only those connecting member hosts.

- Run the **show ip igmp snooping** command to display the basic IGMP snooping information and verify that IGMP snooping is working in IVGL mode.

Related Commands

↳ Enabling Global Multicast

| | |
|------------------------------|---|
| Command | ip multicast wlan |
| Parameter Description | N/A |
| Command Mode | Global configuration mode |
| Usage Guide | After global multicast is enabled, IGMP snooping can be enabled. By default, global multicast is disabled. |

↳ Enabling Global IGMP Snooping on a Fat AP

| | |
|------------------------------|---|
| Command | ip igmp snooping |
| Parameter Description | N/A |
| Command Mode | Global configuration mode |
| Usage Guide | After this command is executed, IGMP snooping will be run on all VLANs. By default, IGMP snooping is disabled. |

↳ Enabling Global IGMP Snooping on an AC

| | |
|------------------------------|--|
| Command | igmp snooping |
| Parameter Description | N/A |
| Command Mode | AP configuration mode |
| Usage Guide | After this command is executed, IGMP snooping will be run on the specified AP. By default, IGMP snooping is disabled. |

↳ Disabling IGMP Snooping for a VLAN

| | |
|------------------------------|--|
| Command | no ip igmp snooping vlan num |
| Parameter Description | N/A |
| Command Mode | Global configuration mode |
| Usage Guide | Only when global IGMP snooping is enabled can it be disabled on specified VLANs. In IVGL mode, you can disable IGMP snooping on any VLAN. |

↳ Displaying the IGMP Snooping Entry

| | |
|---------------------|---|
| Command | show ip igmp snooping gda-table |
| Parameter | N/A |
| Description | |
| Command Mode | Privileged EXEC mode, global configuration mode, or interface configuration mode |
| Usage Guide | This command is used to verify that the ports include only those connecting member hosts. |

▾ **Displaying the IGMP Snooping Working Mode**

| | |
|---------------------|--|
| Command | show ip igmp snooping |
| Parameter | N/A |
| Description | |
| Command Mode | Privileged EXEC mode, global configuration mode, or interface configuration mode |
| Usage Guide | If a device is running in IVGL mode, the following information is displayed: IGMP Snooping running mode: IVGL |

Configuration Example

▾ **Providing Layer-2 Multicast Services for the Subnet Hosts**

| | |
|--|---|
| <p>Scenario Figure 11-7</p> | |
| | <p>A is the multicast router and is connected directly to the multicast source. B is the Layer-2 device and is connected directly to the user host. Receiver 1, Receiver 2, and Receiver 3 belong to VLAN 1.</p> |
| <p>Configuration Steps</p> | <ul style="list-style-type: none"> ● Configure the IP address and VLAN. ● Enable multicast routing on A and enable the multicast routing protocol on Layer-3 interface (Gi0/1 and VLAN 1). ● Enable IGMP snooping on B and select IVGL mode. |
| <p>A</p> | <pre>A# configure terminal</pre> |

| | |
|---------------------|---|
| | <pre>A(config)# ip multicast-routing A(config)# interface GigabitEthernet 0/1 A(config-if-GigabitEthernet 0/1)# ip pim sparse-mode A(config-if-GigabitEthernet 0/1)# exit A(config)# interface vlan 1 A(config-if-VLAN 1)# ip pim sparse-mode A(config-if-VLAN 1)# exit</pre> |
| B | <pre>B# configure terminal B(config)# ip igmp snooping ivgl</pre> |
| Verification | <p>Send packets from the source (10.1.1.1) to G (229.1.1.1) to add Receiver 1 to G.</p> <ul style="list-style-type: none"> ● Confirm that the packets (10.1.1.1 and 229.1.1.1) are received by Receiver 1. ● Display the IGMP snooping forwarding entry on B and ensure that the port (10.1.1.1, 229.1.1.1, 1) includes only Fa0/2. ● Check whether the IGMP snooping working mode is IVGL. |
| B | <pre>B# show ip igmp snooping gda-table Multicast Switching Cache Table D: DYNAMIC S: STATIC M: MROUTE (*, 224.1.1.1, 1): VLAN(1) 2 OPORTS: FastEthernet 0/1(M) FastEthernet 0/2(D)</pre> <pre>B# show ip igmp snooping IGMP Snooping running mode: IVGL IGMP Snooping L2-entry-limit: 65536 Source port check: Disable Source ip check: Disable IGMP Fast-Leave: Disable IGMP Report suppress: Disable IGMP Global Querier: Disable IGMP Preview: Disable IGMP Tunnel: Disable IGMP Preview group aging time : 60(Seconds) Dynamic Mroute Aging Time : 300(Seconds) Dynamic Host Aging Time : 260(Seconds) vlan 1 ----- IGMP Snooping state: Enable</pre> |

| |
|---|
| Multicast router learning mode: pim-dvmrp |
| IGMP Fast-Leave: Disabled |
| IGMP VLAN querier: Disable |
| IGMP VLAN Mode: STATIC |

Common Errors

- The working mode of IGMP snooping is improper.

11.4.2 Configuring the Packet Processing

Configuration Effect

- Configure specified ports as the static router ports to receive the multicast traffic from all profiles.
- Configure specified ports as the static member ports to receive the multicast traffic from specified profiles
- Enable Report packets suppression to forward only the first Report packet from a specified VLAN or profile to the router port within a query interval, and the following Report packets will not be forwarded to the router port, thereby reducing the quantity of packets on the network.
- Configure the immediate-leave function to delete a port from the entry of member ports when a leave packet is received by the port.
- Disable dynamic router port learning to disable the learning of any router port.
- Based on network load and configuration of a multicast device, you can adjust the aging time of a router port and member port as well as the maximum response time of a query packet.

Notes

- Only when basic IGMP snooping is configured can relevant configurations take effect.

Configuration Steps

▾ Configuring a Static Router Port

- Optional.
- You can perform this configuration if you want to specify a static port to receive all the multicast traffic within the VLAN.

▾ Configuring a Static Member Port

- Optional.
- You can perform this configuration if you want to specify a static port to receive specific multicast traffic within the VLAN.

▾ Enabling Report Packet Suppression

- Optional.

- When there are numerous receivers to receive the packets from the same multicast profile, you can enable Report packets suppression to suppress the number of Report packets to be sent.

▾ Enabling the Immediate-Leave Function

- Optional.
- When there is only one receiver on a port, you can enable Leave to speed up the convergence of protocol upon leave.

▾ Disabling Dynamic Router Port Learning

- Optional.
- This function is used when multicast traffic needs to be forwarded only within the Layer-2 topology but not to a Layer-3 router.

▾ Configuring the Maximum Response Time of a Query Packet

- Optional.
- You can configure the aging time based on network load.

Verification

- Run the **show ip igmp snooping mrouter** command to check whether the configured static router port has an "S" in the displayed configuration information.
- Run the **show ip igmp snooping gda** command to check whether the configured static member port is marked with an S.
- Run the **show ip igmp snooping** command to check whether Report packets suppression, immediate leave, router port learning, router port aging time, member port aging time, and the maximum response time of the Query packet take effect.

Related Commands

▾ Configuring a Static Router Port

| | |
|---------------------|--|
| Command | ip igmp snooping vlan <i>vid</i> mrouter interface <i>interface-type interface-number</i> |
| Parameter | <i>vid</i> : Indicates a VLAN. The value ranges from 1 to 4,094. |
| Description | <i>interface-type interface-number</i> : Indicates an interface name. |
| Command Mode | Global configuration mode |
| Usage Guide | In SVGL mode, if a sub VLAN is not configured, only the configurations for the static router port within the shared VLAN can take effect, and the others can be configured but cannot take effect. If a sub VLAN is configured, only the configurations for the static router port within the shared VLAN or a non-sub VLAN can take effect, and the others can be configured but cannot take effect. In IVGL-SVGL mode, if a sub VLAN is not configured, the configurations for the static router ports within all the VLANs can take effect; if a sub VLAN is configured, only the configurations for the static router port within the shared VLAN or a non-sub VLAN can take effect, and the others can be configured but cannot take effect. |

| | |
|--|--|
| | In IVGL mode, the configurations for the static router ports within all the VLANs can take effect. |
|--|--|

↘ Configuring a Static Member Port

| | |
|------------------------------|--|
| Command | ip igmp snooping vlan <i>vid</i> static <i>group-address</i> interface <i>interface-type</i> <i>interface-number</i> |
| Parameter Description | <i>vid</i> : Indicates a VLAN. The value ranges from 1 to 4,094. <i>group-address</i> : Indicates a profile address. <i>interface-type interface-number</i> : Indicates an interface name. |
| Command Mode | Global configuration mode |
| Usage Guide | By default, no static member port is configured. |

↘ Enabling Report Packet Suppression

| | |
|------------------------------|--|
| Command | ip igmp snooping suppression enable |
| Parameter Description | N/A |
| Command Mode | Global configuration mode |
| Usage Guide | When Report packets suppression is enabled, only the first Report packet from a specified VLAN or profile is forwarded to the router port within a Query interval, and the following Report packets will not be forwarded to the router port, thereby reducing the quantity of packets on the network. Only the IGMPv1 and IGMPv2 Report packets can be suppressed, and the IGMPv3 Report packets cannot be suppressed. |

↘ Enabling the Immediate-Leave Function

| | |
|------------------------------|---|
| Command | ip igmp snooping fast-leave enable |
| Parameter Description | N/A |
| Command Mode | Global configuration mode |
| Usage Guide | When this function is enabled, a port will be deleted from the entry of the member port when the port receives a leave packet. After that, the packets will no longer be forwarded to this port when it receives the query packets of specified profiles. Leave packets include the IGMPv2 Leave packets as well as the IGMPv3 Report packets that include types but carry no source address. The immediate-leave function applies only to the scenario where only one host is connected to a device port. It is used to conserve bandwidth and resources. |

↘ Enabling Dynamic Router Port Learning

| | |
|------------------------------|--|
| Command | ip igmp snooping [vlan <i>vid</i>] mrouter learn pim-dvmrp |
| Parameter Description | vlan <i>vid</i> : Specifies a VLAN. This configuration applies to all VLANs by default. |
| Command | Global configuration mode |

| | |
|--------------------|--|
| Mode | |
| Usage Guide | A router port is the port that is connected directly to a multicast device running IGMP snooping and a multicast neighbor device running multicast routing protocol. By default, dynamic router port learning is enabled and the device automatically listens to IGMP Query packets, DVMRP packets, and PIM Hello packets. |

📌 Configuring the Aging Time of a Dynamic Member Port

| | |
|------------------------------|--|
| Command | ip igmp snooping host-aging-time <i>seconds</i> |
| Parameter Description | <i>seconds</i> : Indicates the aging time. |
| Command Mode | Global configuration mode |
| Usage Guide | <p>The aging time of a dynamic member port indicates the time when a device port receives the IGMP join packet sent from host for subscribing to an IP multicast profile.</p> <p>When the IGMP join packet is received, the aging time of the dynamic member port will be reset. The value of the timer time is host-aging-time. If the timer expires, the multicast device deems that no user host for receiving the multicast packet exists under the port, and will delete the port from the entry of IGMP snooping member port. After the aging time is configured, the aging time of following received IGMP join packets will be host-aging-time. This configuration takes effect after the next IGMP join packet is received, and the timer of the port in use will not be refreshed.</p> |

📌 Configuring the Maximum Response Time of a Query Packet

| | |
|------------------------------|---|
| Command | ip igmp snooping query-max-response-time <i>seconds</i> |
| Parameter Description | <i>seconds</i> : Indicates the maximum response time. |
| Command Mode | Global configuration mode |
| Usage Guide | <p>When an IGMP general Query packet is received, the multicast device will reset the aging time of all the dynamic member ports, which is query-max-response-time. If the timer expires, the multicast device deems that no user host for receiving the multicast packet exists under the port, and will delete the port from the entry of IGMP snooping member port.</p> <p>When an IGMP profile-specific Query packet is received, the multicast device will reset the aging time of all the dynamic member ports of the specific profile, which is query-max-response-time. If the timer expires, the multicast device deems that no user host for receiving the multicast packet exists under the port, and will delete the port from the entry of IGMP snooping member port.</p> <p>This configuration takes effect after the next Query packet is received, and the timer in use will not be refreshed. The timer of an IGMPv3 profile-specific Query packet is not refreshed.</p> |

📌 Displaying Router Ports

| | |
|------------------|-------------------------------------|
| Command | show ip igmp snooping mroute |
| Parameter | N/A |

| | |
|---------------------|---|
| Description | |
| Command Mode | Privileged EXEC mode, global configuration mode, or interface configuration mode |
| Usage Guide | <p>If the router port is successfully configured, an "S" will be displayed in the port information.</p> <pre>Ruijie(config)#show ip igmp snooping mrouter Multicast Switching Mroute Port D: DYNAMIC S: STATIC (*, *, 1): VLAN(1) 1 MROUTES: GigabitEthernet 0/1(S)</pre> |

▾ Displaying the Information of Dynamic Router Port Learning

| | |
|------------------------------|---|
| Command | show ip igmp snooping |
| Parameter Description | N/A |
| Command Mode | Privileged EXEC mode, global configuration mode, or interface configuration mode |
| Usage Guide | <p>Run the show ip igmp snooping command to display the aging time and learning status of the dynamic router port.</p> <pre>Dynamic Mroute Aging Time : 300(Seconds) Multicast router learning mode: pim-dvmrp</pre> |

▾ Displaying the Information of a Member Port

| | |
|------------------------------|--|
| Command | show ip igmp snooping gda-table |
| Parameter Description | N/A |
| Command Mode | Privileged EXEC mode, global configuration mode, or interface configuration mode |
| Usage Guide | <p>If the member port is successfully configured, an "S" will be displayed in the port information.</p> <pre>Ruijie(config)#show ip igmp snooping gda-table Multicast Switching Cache Table D: DYNAMIC S: STATIC M: MROUTE (*, 224.1.1.1, 1): VLAN(1) 1 OPORTS: GigabitEthernet 0/1(S)</pre> |

▾ Displaying Other Parameters

| | |
|----------------|------------------------------|
| Command | show ip igmp snooping |
|----------------|------------------------------|

| | |
|------------------------------|---|
| Parameter Description | N/A |
| Command Mode | Privileged EXEC mode, global configuration mode, or interface configuration mode |
| Usage Guide | <p>Run the show ip igmp snooping command to display the aging time of the router port, aging time of the dynamic member port, response time of the query packet, and Report packets suppression, and immediate leave.</p> <pre> IGMP Fast-Leave: Enable IGMP Report suppress: Enable Query Max Response Time: 20(Seconds) Dynamic Mroute Aging Time : 300(Seconds) Dynamic Host Aging Time : 260(Seconds) </pre> |

Configuration Example

▾ Configuring a Static Router Port and Static Member Port

| | |
|----------------------------|--|
| Configuration Steps | <ul style="list-style-type: none"> ● Configure basic IGMP snooping functions. ● Configure a static router port and static member port. |
| | <pre> Ruijie# configure terminal Ruijie(config)# ip igmp snooping vlan 1 mrouter interface GigabitEthernet 0/0 Ruijie(config)# ip igmp snooping vlan 1 static 224.1.1.1 interface GigabitEthernet 0/0 Ruijie(config)# end </pre> |
| Verification | Run the show ip igmp snooping mrouter and show ip igmp snooping gda-table commands to check whether the configuration takes effect. |
| | <pre> Ruijie#show ip igmp snooping mrouter Multicast Switching Mroute Port D: DYNAMIC S: STATIC (*, *, 1): VLAN(1) 1 MROUTES: GigabitEthernet 0/0(S) Ruijie#show ip igmp snooping gda-table Multicast Switching Cache Table D: DYNAMIC S: STATIC M: MROUTE (*, 224.1.1.1, 1): VLAN(1) 1 OPORTS: GigabitEthernet 0/0(SM) </pre> |

▾ Enabling Report Packet Suppression

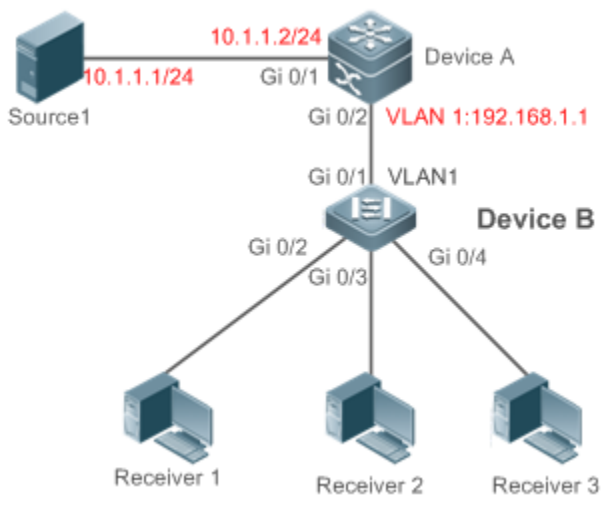
| | |
|---------------------------------------|--|
| Scenario Figure 11-8 |  |
| | <p>A is the multicast router and is connected directly to multicast Source 1.</p> <p>B is a Layer-2 device and is connected directly to the user host and multicast Source 2.</p> <p>Receiver 1, Receiver 2, and Receiver 3 are connected to VLAN 1.</p> |
| Configuration Steps | <ul style="list-style-type: none"> ● Configure the IP address and VLAN. (Omitted) ● Enable multicast routing on A and enable the multicast routing protocol on Layer-3 interface (Gi0/1 and VLAN 1). ● Enable IGMP snooping on B and select IVGL mode. ● Enable Report packets suppression on B. |
| A | <pre>A# configure terminal A(config)# ip multicast-routing A(config)# interface GigabitEthernet 0/1 A(config-if-GigabitEthernet 0/1)# ip pim sparse-mode A(config-if-GigabitEthernet 0/1)# exit A(config)# interface vlan 1 A(config-if-VLAN 1)# ip pim sparse-mode A(config-if-VLAN 1)# exit</pre> |
| B | <pre>B# configure terminal B(config)# ip igmp snooping ivgl B(config)# ip igmp snooping suppression enable</pre> |
| Verification | <p>Check whether Receiver 1 and Receiver 2 are added to profile 239.1.1.1, and only the IGMP Report packets of profile 239.1.1.1 are forwarded from interface Gi0/1 of B.</p> |
| B | <pre>B# show ip igmp snooping IGMP Snooping running mode: IVGL IGMP Snooping L2-entry-limit: 65536 Source port check: Disable Source ip check: Disable</pre> |

| | |
|--|--|
| | <pre> IGMP Fast-Leave: Disable IGMP Report suppress: Enable IGMP Globle Querier: Disable IGMP Preview: Disable IGMP Tunnel: Disable IGMP Preview group aging time : 60(Seconds) Dynamic Mroute Aging Time : 300(Seconds) Dynamic Host Aging Time : 260(Seconds) </pre> |
|--|--|

▾ Configuring Other Parameters

| | |
|----------------------------|---|
| Configuration Steps | <ul style="list-style-type: none"> ● Configure basic IGMP snooping functions. ● Enable Immediate-leave function. ● Disable router port learning. ● Configure the aging time of a router port. ● Configuring the aging time of a member port. ● Configure the response time of a Query packet. |
| | <pre> Ruijie# configure terminal Ruijie(config)# ip igmp snooping fast-leave enable Ruijie(config)# no ip igmp snooping mrouter learn pim-dvmrp Ruijie(config)#ip igmp snooping dyn-mr-aging-time 200 Ruijie(config)#ip igmp snooping host-aging-time 100 Ruijie(config)#ip igmp snooping query-max-response-time 60 Ruijie(config)# end </pre> |
| Verification | Run the show ip igmp snooping command to check whether the configuration is successful. |
| | <pre> Ruijie#show ip igmp snooping IGMP Snooping running mode: IVGL IGMP Snooping L2-entry-limit: 65536 Source port check: Disable Source ip check: Disable IGMP Fast-Leave: Enable IGMP Report suppress: Enable IGMP Globle Querier: Disable IGMP Preview: Disable IGMP Tunnel: Disable Query Max Response Time: 60(Seconds) IGMP Preview group aging time : 60(Seconds) Dynamic Host Aging Time : 100(Seconds) </pre> |

Common Errors

- Basic IGMP snooping functions are not configured or the configuration is not successful.

11.4.3 Configuring an IGMP Querier

Configuration Effect

- Configure the device as an IGMP querier, which will send IGMP Query packets periodically and collect user demanding information.

Notes

- Basic IGMP snooping functions must be configured.

Configuration Steps

▾ Enabling the Querier Function

- (Optional) Enable IGMP querier function globally or for a specified VLAN.
- (Optional) Disable the IGMP querier function for a specified VLAN.

▾ Configuring the Source IP Address of a Querier

- (Optional) You can configure the source IP address of a Query packet sent by the querier based on VLANs.
- After a querier is enabled, a source IP address must be specified for the querier; otherwise, the configuration will not take effect.

▾ Configuring the Maximum Response Time of a Query Packet

- (Optional) Adjust the maximum response time carried by an IGMP Query packet. As IGMPv1 does not support the carrying of maximum response time by a Query packet, this configuration does not take effect when the querier is running IGMPv1.

▾ Configuring the Query Interval of a Querier

- (Optional) Adjust the interval of the IGMP querier for sending query packets.

▾ Configuring the Aging Timer of a Querier

- (Optional) Configure the aging timer of other IGMP queriers on the network.

▾ Specifying the IGMP Version for a Querier

- (Optional) Specify the IGMP version for a querier (IGMPv2 by default).

Verification

- Run the **show ip igmp snooping querier detail** command to check whether the configuration takes effect.

Related Commands

▾ Enabling the IGMP Querier Function

| | |
|---------|---|
| Command | ip igmp snooping [vlan <i>vid</i>] querier |
|---------|---|

| | |
|------------------------------|---|
| Parameter Description | vlan vid: Specifies a VLAN. This configuration applies to all VLANs by default. |
| Command Mode | Global configuration mode |
| Usage Guide | IGMP querier for a specified VLAN will take effect only after global IGMP querier is enabled. If global IGMP querier is disabled, IGMP querier for all the VLANs will be disabled. |

↘ Configuring the Source IP Address of a Querier

| | |
|------------------------------|--|
| Command | ip igmp snooping [vlan vid] querier address a.b.c.d |
| Parameter Description | vlan vid: Specifies a VLAN. This configuration applies to all VLANs by default. a.b.c.d: Indicates the source IP address. |
| Command Mode | Global configuration mode |
| Usage Guide | After a querier is enabled, a source IP address must be specified for the querier; otherwise, the configuration will not take effect. If the source IP address is specified by a VLAN, the address will be used preferentially. |

↘ Configuring the Maximum Response Time of a Querier

| | |
|------------------------------|---|
| Command | ip igmp snooping [vlan vid] querier max-response-time seconds |
| Parameter Description | vlan vid: Specifies a VLAN. This configuration applies to all VLANs by default. seconds: Indicates the maximum response time. in the unit of seconds. The value ranges from 1 to 25. |
| Command Mode | Global configuration mode |
| Usage Guide | If the query interval is specified by a VLAN, the value will be used preferentially. |

↘ Configuring the Query Interval of a Querier

| | |
|------------------------------|---|
| Command | ip igmp snooping [vlan vid] querier address a.b.c.d |
| Parameter Description | vlan vid: Specifies a VLAN. This configuration applies to all VLANs by default. seconds: Indicates the query interval in the unit of seconds. The value ranges from 1 to 18,000. |
| Command Mode | Global configuration mode |
| Usage Guide | If the query interval is specified by a VLAN, the value will be used preferentially. |

↘ Configuring the Aging Timer of a Querier

| | |
|------------------------------|---|
| Command | ip igmp snooping [vlan vid] querier timer expiry seconds |
| Parameter Description | vlan vid: Specifies a VLAN. This configuration applies to all VLANs by default. seconds: Indicates the timeout time in the unit of seconds. The value ranges from 60 to 300. |
| Command Mode | Global configuration mode |
| Usage Guide | A device may fail to be elected as the querier even when its querier function is enabled. If a device that fails |

| | |
|--|--|
| | <p>to be elected does not receive the Query packet sent by the querier in the aging time, the querier in use is considered as expired, and a new round of election will be raised.</p> <p>If the aging time is specified by a VLAN, the value will be used preferentially.</p> |
|--|--|

📌 **Specifying the IGMP Version for a Querier**

| | |
|------------------------------|--|
| Command | ip igmp snooping [vlan vid] querier version 1 |
| Parameter Description | vlan vid: Specifies a VLAN. This configuration applies to all VLANs by default. |
| Command Mode | Global configuration mode |
| Usage Guide | <p>A querier can be run in IGMPv1 and IGMPv2 (IGMPv2 by default). You can also run a command to configure the version to IGMPv1.</p> <p>If the IGMP version for a querier is specified by a VLAN, the version will be used preferentially.</p> |

📌 **Displaying the IGMP Querier Configuration**

| | |
|------------------------------|--|
| Command | show ip igmp snooping querier detail |
| Parameter Description | N/A |
| Command Mode | Privileged EXEC mode, global configuration mode, or interface configuration mode |
| Usage Guide | <p>If QinQ is enabled, the following content is displayed.</p> <pre>Ruijie(config)#show ip igmp snooping querier detail Vlan IP Address IGMP Version Port ----- Global IGMP switch querier status ----- admin state : Enable admin version : 2 source IP address : 1.1.1.1 query-interval (sec) : 60 max-response-time (sec) : 10 querier-timeout (sec) : 125 Vlan 1: IGMP switch querier status ----- admin state : Disable admin version : 2 source IP address : 1.1.1.1 query-interval (sec) : 60 max-response-time (sec) : 10</pre> |

| | |
|-----------------------|-----------|
| querier-timeout (sec) | : 125 |
| operational state | : Disable |
| operational version | : 2 |

Configuration Example

Enabling the IGMP Querier Function

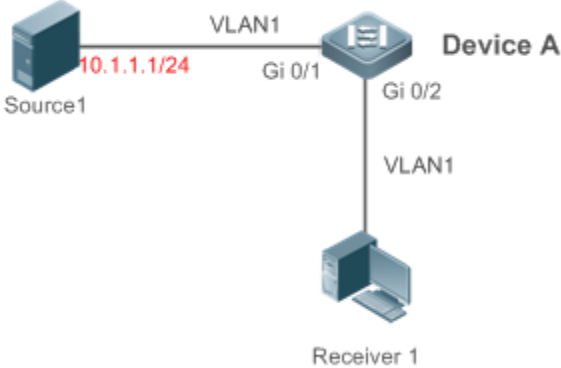
| | |
|--|--|
| <p>Scenario Figure 11-9</p> |  |
| | <p>In the scenario without Layer-3 multicast equipment, the multicast traffic can be forwarded only on the Layer-2 network. A acts as a Layer-2 device to connect to the multicast source and receiver.</p> |
| <p>Configuration Steps</p> | <ul style="list-style-type: none"> ● Enable global IGMP snooping on A in IVGL mode. ● Enable IGMP querier for VLAN 1 on A. |
| <p>A</p> | <pre>A(config)#ip igmp snooping ivgl A(config)#ip igmp snooping querier A(config)#ip igmp snooping querier address 10.1.1.1 A(config)#ip igmp snooping vlan 1 querier</pre> |
| <p>Verification</p> | <p>Run the show ip igmp snooping querier command to check whether the querier of VLAN 1 takes effect.</p> |
| <p>A</p> | <pre>A(config)#show ip igmp snooping querier Vlan IP Address IGMP Version Port ----- 1 10.1.1.1 2 switch A(config)#show ip igmp snooping querier vlan 1 Vlan 1: IGMP switch querier status ----- elected querier is 10.1.1.1 (this switch querier) ----- admin state : Enable</pre> |

| | | |
|-------------------------|---|----------|
| admin version | : | 2 |
| source IP address | : | 10.1.1.1 |
| query-interval (sec) | : | 60 |
| max-response-time (sec) | : | 10 |
| querier-timeout (sec) | : | 125 |
| operational state | : | Querier |
| operational version | : | 2 |

Common Errors

- The source IP address is not configured for the querier and the querier does not take effect.

11.4.4 Configuring Multicast-to-Unicast Conversion

Configuration Effect

- Enable the multicast-to-unicast conversion on the AP, which transmits multicast packets to STAs in unicast mode.

Notes

- IGMP Snooping basic functions must be configured.

Configuration Steps

▾ Enabling Global Multicast

- (Mandatory) Enable global multicast in global mode.
- If global multicast is disabled in global mode, a wireless device directly discards received packets.

▾ Enabling Multicast-to-Unicast Conversion

- (Optional) Configure whether to enable multicast-to-unicast conversion. After multicast-to-unicast conversion is enabled, after packets reach the AP, the AP judges the multicast packets that need to be transmitted in unicast mode and transmits such packets in unicast mode.

▾ Configuring the Multicast Range for Multicast-to-Unicast Conversion

- (Optional) Multicast-to-unicast conversion is available to all multicast groups by default. A multicast range can be configured to allow multicast packets to be transmitted in unicast mode, so as to utilize AP resources to the maximum extent.

▾ Configuring the Maximum Number of Multicast Profiles that Are Allowed to Use Multicast-to-Unicast Conversion

- (Optional) The maximum number of multicast profiles that are allowed to use multicast-to-unicast conversion can be adjusted.
- It is used in combination with the multicast range of multicast-to-unicast conversion.

Verification

- Run the show ip igmp snooping command to check whether the configuration takes effect.

Related Commands

▾ Configuring Global Multicast

| | |
|---------------------|---|
| Command | ip multicast wlan |
| Parameter | N/A |
| Description | |
| Command Mode | Global configuration mode |
| Usage Guide | If global multicast is enabled, multicast packets are processed only after they reach the AC. If global multicast is disabled, the AC directly discards the received multicast packets. |

▾ Configuring Multicast-to-Unicast Conversion

| | |
|---------------------|---|
| Command | igmp snooping mcast-to-unicast enable |
| Parameter | N/A |
| Description | |
| Command Mode | ap-config mode on the AC or global configuration mode on the fat AP |
| Usage Guide | After multicast-to-unicast conversion is enabled, when multicast packets reach the AP, the AP judges the multicast packets that need to be transmitted in unicast mode according to the multicast-to-unicast conversion policy. |

▾ Configuring the Maximum Multicast Range for Multicast-to-Unicast Conversion

| | |
|------------------------------|---|
| Command | igmp snooping mcast-to-unicast group-range <i>ip-addr ip-addr</i> |
| Parameter Description | <i>ip-addr</i> : Indicates the multicast profile range. The value must be valid multicast addresses and ranges from 224.0.1.0 to 239.255.255.255. |
| Command Mode | Ap-config mode on the AC or global configuration mode on the fat AP |
| Usage Guide | If the multicast range of multicast-to-unicast conversion is not configured, multicast-to-unicast conversion is available to all multicast profiles by default. |

▾ Configuring the Maximum Number of Multicast Profiles That Are Allowed to Use Multicast-to-Unicast Conversion

| | |
|------------------------------|---|
| Command | igmp snooping mcast-to-unicast max-group <i>number</i> |
| Parameter Description | <i>number</i> : Indicates the maximum number of multicast profiles that are allowed to use multicast-to-unicast conversion. The value ranges from 1 to 64. The default value is 64. |
| Command Mode | ap-config mode on the AC or global configuration mode on the fat AP |

| | |
|--------------------|--|
| Usage Guide | It can be used in combination with the maximum multicast range of multicast-to-unicast conversion so as to properly allocate bandwidth and effectively control AP resources. |
|--------------------|--|

↘ **Displaying Multicast-to-Unicast Conversion Configuration**

| | |
|------------------------------|--|
| Command | show ip igmp snooping |
| Parameter Description | N/A |
| Command Mode | Privileged EXEC mode, global configuration mode, and interface configuration mode |
| Usage Guide | <p>If multicast-to-unicast conversion is configured successfully, the following information is displayed:</p> <pre>Ruijie(config)#sh ip igmp snooping WLAN Multicast: Enable IGMP Snooping running mode: IVGL IGMP Snooping M2U-Forward: Enable IGMP Snooping Support M2U Max-Group Num: 64 IGMP Snooping M2U Group range: 233.3.3.1-233.3.3.64 IGMP Snooping L2-entry-limit: 65536 Source port check: Disable Source ip check: Disable IGMP Fast-Leave: Disable IGMP Report suppress: Disable IGMP Global Querier: Disable IGMP Preview: Disable IGMP Tunnel: Disable IGMP Preview group aging time : 60(Seconds) Dynamic Mroute Aging Time : 300(Seconds) Dynamic Host Aging Time : 260(Seconds)</pre> |

Configuration Example

i The following configuration example describes only configurations related to IGMP Snooping.

↘ **Enabling the IGMP Querier**

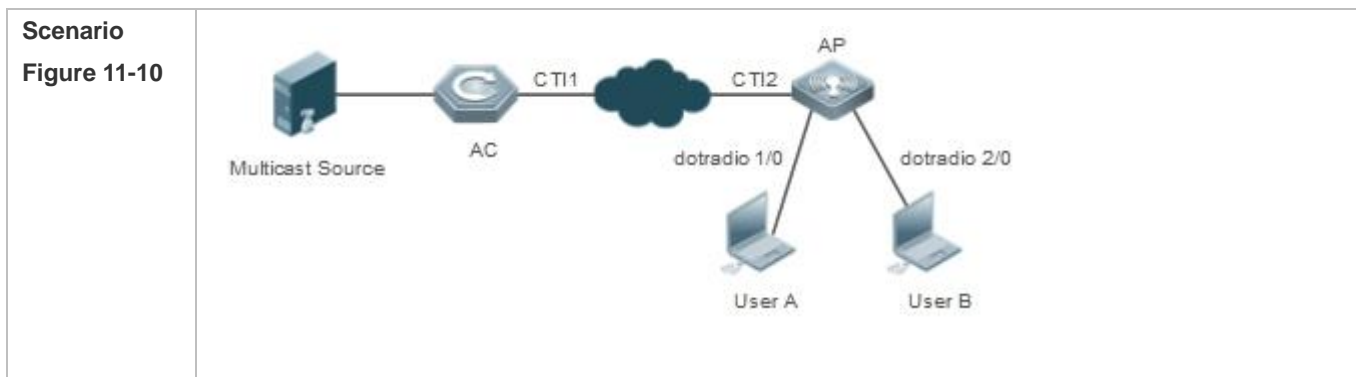

| | |
|----------------------------|--|
| | <p>Multicast streams only need to be forwarded at Layer 2 in network deployment and there is no device supporting the Layer-3 multicast function in the network.</p> <p>User A and User B are multicast receivers.</p> |
| Configuration Steps | <ul style="list-style-type: none"> ● Enable IGMP Snooping on the AC. ● Enable global multicast on the AC. ● Enable IGMP Snooping in ap-config mode. ● Enable multicast-to-unicast conversion in ap-config mode. ● Configure the maximum multicast range for multicast-to-unicast conversion in ap-config mode. ● Configure the maximum number of multicast profiles that are allowed to support multicast-to-unicast conversion in ap-config mode. |
| A | <pre>A(config)#ip igmp snooping ivgl A(config)#ip multicast wlan A(config)#ap-confing all A(config-ap)#igmp snooping A(config)#igmp snooping mcast-to-unicast enable A(config-ap)#igmp snooping mcast-to-unicast group-range 233.1.1.1 233.255.255.255 A(config-ap)#igmp snooping mcast-to-unicast max-group 10</pre> |
| Verification | Run the show ip igmp snooping command to check whether the configuration takes effect. |
| A | <pre>A(config)# sh ip igmp snooping WLAN Multicast: Enable IGMP Snooping running mode: IVGL IGMP Snooping M2U-Forward: Enable IGMP Snooping Support M2U Max-Group Num: 64 IGMP Snooping M2U Group range: 233.3.3.1-233.3.3.64 IGMP Snooping L2-entry-limit: 65536 Source port check: Disable Source ip check: Disable IGMP Fast-Leave: Disable IGMP Report suppress: Disable IGMP Global Querier: Disable IGMP Preview: Disable IGMP Tunnel: Disable IGMP Preview group aging time : 60(Seconds) Dynamic Mroute Aging Time : 300(Seconds) Dynamic Host Aging Time : 260(Seconds)</pre> |

Common Errors

- Multicast packets are not processed because global multicast is not configured.

11.4.5 Optimizing the Wireless Multicast Environment

Configuration Effect

- Configure the function of ignoring port timer resetting for query packets on the wireless device.

Notes

- IGMP Snooping basic functions must be configured.

Configuration Steps

▾ Configuring the Function of Ignoring Port Aging Timer Resetting for Query Packets

- (Optional) Configure the function of ignoring port aging timer resetting for query packets so that the port does not age within multiple query intervals.

Verification

- Run the **show ip igmp snooping** command to check whether the configuration takes effect.

Related Commands

▾ Configuring the Function of Ignoring Port Aging Timer Resetting for Query Packets

| | |
|------------------------------|---|
| Command | Ip igmp snooping ignore-query-timer |
| Parameter Description | N/A |
| Command Mode | Global configuration mode or ap-config mode |
| Usage Guide | After the function of ignoring port aging timer for query packets is configured, the port does not age within multiple query intervals. When the port receives a Report request, the port aging timer resets. |

11.5 Monitoring

Clearing

 Running the **clear** commands may lose vital information and thus interrupt services.

| Description | Command |
|---|---|
| Clears the dynamic router ports and member ports. | clear ip igmp snooping gda-table |

Displaying

| Description | Command |
|--|--|
| Displays basic IGMP snooping configurations. | show ip igmp snooping [vlan <i>vlan-id</i>] |
| Displays the router ports. | show ip igmp snooping mrouter |

| | |
|-------------------------------------|---|
| Displays the IGMP snooping entries. | show ip igmp snooping gda-table |
| Displays the IGMP querier. | show ip igmp snooping querier [detail] |
| Displays user information. | show ip igmp snooping user-info |

Debugging

 System resources are occupied when debugging information is output. Therefore, disable debugging immediately after use.

| Description | Command |
|--|-------------------------------|
| Debugs all IGMP Snooping functions. | debug igmp-snp |
| Debugs the IGMP snooping events. | debug igmp-snp event |
| Debugs the IGMP snooping packets. | debug igmp-snp packet |
| Debugs the communications between IGMP snooping and MSF. | debug igmp-snp msf |
| Debugs the IGMP snooping alarms. | debug igmp-snp warning |

12 Configuring the ACL

12.1 Overview

Access control list (ACL) is also called access list or firewall. It is even called packet filtering in some documents. The ACL defines rules to determine whether to forward or drop data packets arriving at a network interface.

ACLs are classified by function into two types:

- Security ACLs: Used to control data flows that are allowed to pass through a network device.
- Quality of service (QoS) ACLs: Used to classify and process data flows by priority.

ACLs are configured for a lot of reasons. Major reasons include:

- Network access control: To ensure network security, rules are defined to limit access of users to some services (for example, only access to the WWW and email services is permitted, and access to other services such as Telnet is prohibited), or to allow users to access services in a specified period of time, or to allow only specified hosts to access the network.
- QoS: QoS ACLs are used to preferentially classify and process important data flows. For details about the use of QoS ACLs, see the configuration manual related to QoS.

12.2 Applications

| Application | Description |
|---|---|
| Access Control of an Enterprise Network | On an enterprise network, the network access rights of each department, for example, access rights of servers and use permissions of chatting tools (such as QQ and MSN), must be controlled according to requirements. |

12.2.1 Access Control of an Enterprise Network

Scenario

Internet viruses can be found everywhere. Therefore, it is necessary to block ports that are often used by viruses to ensure security of an enterprise network as follows:

- Allow only internal PCs to access the server.
- Prohibit PCs of a non-financial department from accessing PCs of the financial department, and prohibit PCs of a non-R&D department from accessing PCs of the R&D department.
- Prohibit the staff of the R&D department from using chatting tools (such as QQ and MSN) during working hours from 09:00 to 18:00.

Figure 12-1

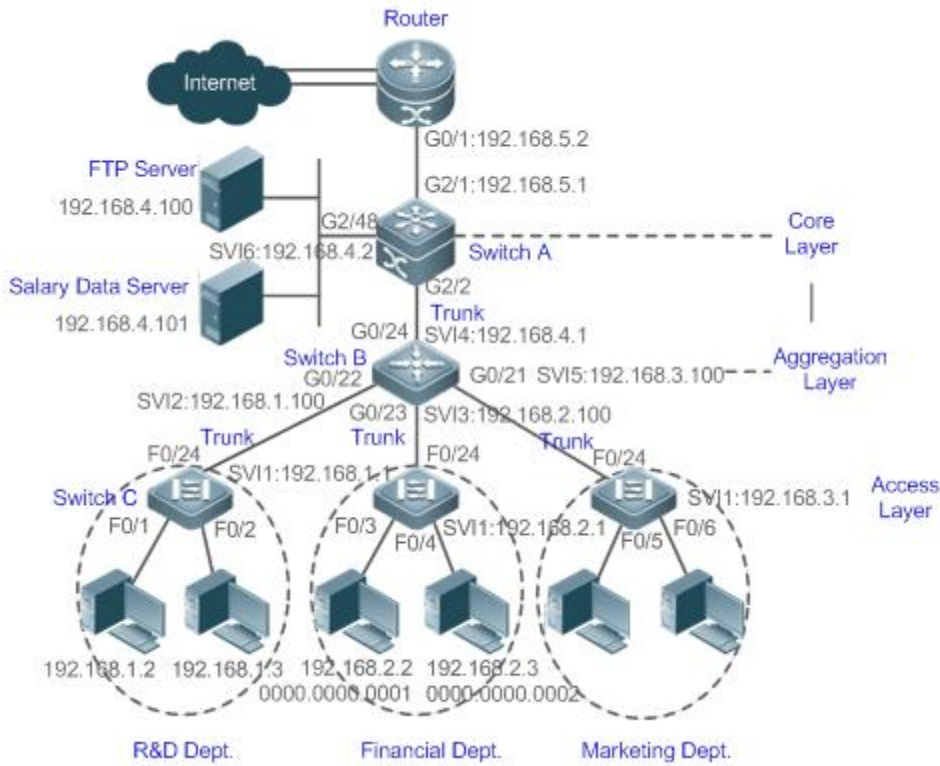

| | |
|----------------|--|
| Remarks | <p>Switch C at the access layer:It is connected to PCs of each department and to Switch B at the aggregation layer through the gigabit optical fiber (trunk mode).</p> <p>Switch B at the aggregation layer:Multiple virtual local area networks (VLANs) are divided. One VLAN is defined for one department. These VLANs are connected to Switch A at the core layer through the 10-gigabit optical fiber (trunk mode).</p> <p>Switch A at the core layer:It is connected to various servers, such as the File Transfer Protocol (FTP) server and Hypertext Transfer Protocol (HTTP) server, and to the Internet through firewalls.</p> |
|----------------|--|

Deployment

- Configure an extended ACL on the port G2/1 to filter data packets, thus protecting the network against the viruses. This port is located on a core-layer device (Switch A) and used to connect Switch A to the uplink port G2/1 of a router.
- Allow only internal PCs to access servers, and prohibit external PCs from accessing servers. Define and apply the extended IP ACLs on G2/2 or switch virtual interface (SVI) 2 that is used to connect Switch A to an aggregation layer device or server.
- Prohibit mutual access between specified departments. Define and apply the extended IP ACLs on G0/22 and G0/23 of Switch B.
- Configure and apply the time-based extended IP ACLs on SVI 2 of Switch B to prohibit the R&D department from using chatting tools (such as QQ and MSN) in a specified period of time.

12.3 Features

Basic Concepts

ACL

ACLs include basic ACLs and dynamic ACLs.

You can select basic or dynamic ACLs as required. Generally, basic ACLs can meet the security requirements. However, experienced hackers may use certain software to access the network by means of IP address spoofing. If dynamic ACLs are used, users are requested to pass identify authentication before accessing the network, which prevents hackers from intruding the network. Therefore, you can use dynamic ACLs in some sensitive areas to guarantee network security.

-
- i** IP address spoofing is an inherent problem of all ACLs, including dynamic ACLs. Hackers may use forged IP addresses to access the network during the validity period of authenticated user identities. Two methods are available to resolve this problem. One is to set the idle time of user access to a smaller value, which increases the difficulty in intruding networks. The other is to encrypt network data using the IPSec protocol, which ensures that all data is encrypted when arriving at a device.
-

ACLs are generally configured on the following network devices:

- Devices between the internal network and the external network (such as the Internet)
- Devices on the border of two network segments
- Devices connected to controlled ports

ACL statements must be executed in strict compliance with their sequence in the ACL. Comparison starts from the first statement. Once the header of a data packet matches a statement in the ACL, the subsequent statements are ignored and no longer checked.

Input/Output ACLs, Filtering Field Template, and Rules

When receiving a packet on an interface, the device checks whether the packet matches any access control entry (ACE) in the input ACL of this interface. Before sending a packet through a interface, the device checks whether the packet matches any ACE in the output ACL of this interface.

When different filtering rules are defined, all or only some rules may be applied simultaneously. If a packet matches an ACE, this packet is processed according to the action policy (permit or deny) defined in this ACE. ACEs in an ACL identify Ethernet packets based on the following fields in the Ethernet packets:

Layer 2 (L2) fields:

- 48-bit source MAC address (containing all 48 bits)
- 48-bit destination MAC address (containing all 48 bits)
- 16-bit L2 type field

Layer 3 (L3) fields:

- Source IP address field (All source IP address values can be specified, or the subnet can be used to define a type of data flows.)
- Destination IP address field (All destination IP address values can be specified, or the subnet can be used to define a type of data flows.)
- Protocol type field

Layer 4 (L4) fields:

- Either a TCP source or destination port is specified, or both are specified, or the range of the source or destination port is specified.
- Either a UDP source or destination port is specified, or both are specified, or the range of the source or destination port is specified.

Filtering fields refer to the fields in packets that can be used to identify or classify packets when an ACE is generated. A filtering field template is a combination of these fields. For example, when an ACE is generated, packets are identified and classified based on the destination IP address field in each packet; when another ACE is generated, packets are identified and classified based on the source IP address field and UDP source port field in each packet. The two ACEs use different filtering field templates.

Rules refer to values of fields in the filtering field template of an ACE. For example, the content of an ACE is as follows:

```
permit tcp host 192.168.12.2 any eq telnet
```

In this ACE, the filtering field template is a combination of the following fields: source IP address field, IP protocol field, and TCP destination port field. The corresponding values (rules) are as follows: source IP address = Host 192.168.12.2; IP protocol = TCP; TCP destination port = Telnet.

Figure 12-2 Analysis of the ACE: permit tcp host 192.168.12.2 any eq telnet

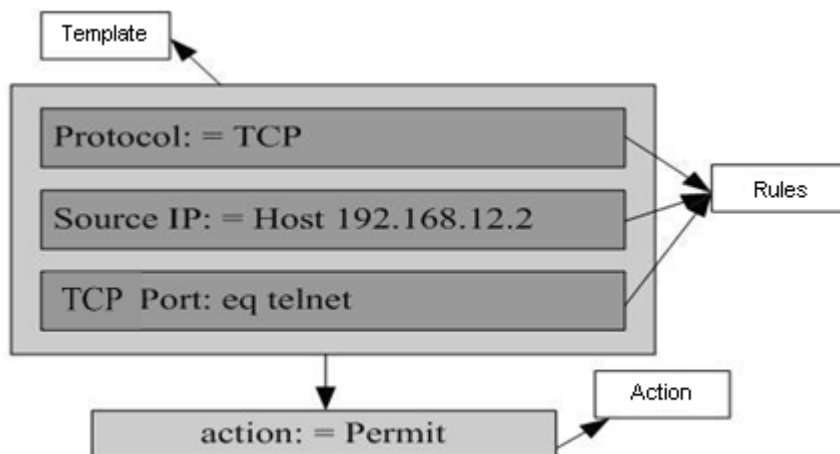

i A filtering field template can be a combination of L3 and L4 fields, or a combination of multiple L2 fields. The filtering field template of a standard or an extended ACL, however, cannot be a combination of L2 and L3 fields, a combination

of L2 and L4 fields, or a combination of L2, L3, and L4 fields. To use a combination of L2, L3, and L4 fields, you can use the expert ACLs.

- i** An SVI associated with ACLs in the outgoing direction supports the IP standard, IP extended, MAC extended, and expert ACLs.
- i** If an expert ACL is configured and applied to the outgoing direction of an interface, and some ACEs in this ACL contain the L3 matching information (e.g. the IP address and L4 port), non-IP packets sent to the device from this interface cannot be controlled by the permit and deny ACEs in this ACL.
- i** If ACEs of an ACL (IP ACL or expert extended ACL) are configured to match non-L2 fields (such as SIP and DIP), the ACL does not take effect on tagged MPLS packets.

Overview

| Feature | Description |
|-------------------------------------|--|
| IP ACL | Control incoming or outgoing IPv4 packets of a device based on the L3 or L4 information in the IPv4 packet header. |
| MAC Extended ACL | Control incoming or outgoing L2 packets of a device based on the L2 information in the Ethernet packet header. |
| Expert Extended ACL | Combine the IP ACL and MAC extended ACL into an expert extended ACL, which controls (permits or denies) incoming or outgoing packets of a device using the same rule based on the L2, L3, and L4 information in the packet header. |
| IPv6 ACL | Control incoming or outgoing IPv6 packets of a device based on the L3 or L4 information in the IPv6 packet header. |
| Security Channel | Allow packets to bypass the check of access control applications, such as DOT1X and Web authentication, to meet requirements of some special scenarios. |
| SVI Router ACL | Enable users in the same VLAN to communicate with each other. |

12.3.1 IP ACL

The IP ACL implements refined control on incoming and outgoing IPv4 packets of a device. You can permit or deny the entry of specific IPv4 packets to a network according to actual requirements to control access of IP users to network resources.

Working Principle

Define a series of IP access rules in the IP ACL, and then apply the IP ACL either in the incoming or outgoing direction of an interface or globally. The device checks whether the incoming or outgoing IPv4 packets match the rules and accordingly forwards or blocks these packets.

To configure an IP ACL, you must specify a unique name or ID for the ACL of a protocol so that the protocol can uniquely identify each ACL. The following table lists the protocols that can use IDs to identify ACLs and the range of IDs.

| Protocol | ID Range |
|-------------|--------------------|
| Standard IP | 1–99, 1300–1999 |
| Extended IP | 100–199, 2000–2699 |

Basic ACLs include the standard IP ACLs and extended IP ACLs. Typical rules defined in an ACL contain the following matching fields:

- Source IP address
- Destination IP address
- IP protocol number
- L4 source port ID or ICMP type
- L4 destination port ID or ICMP code

The standard IP ACL (ID range: 1–99, 1300–1999) is used to forward or block packets based on the source IP address, whereas the extended IP ACL (ID range: 100–199, 2000–2699) is used to forward or block packets based on a combination of the preceding matching fields.

For an individual ACL, multiple independent ACL statements can be used to define multiple rules. All statements reference the same ID or name so that these statements are bound with the same ACL. However, more statements mean that it is increasingly difficult to read and understand the ACL.

- ✔ For routing products, the ICMP code matching field in an ACL rule is ineffective for ICMP packets whose ICMP type is 3. If the ICMP code of ICMP packets to be matched is configured in an ACL rule, the ACL matching result of incoming ICMP packets of a device whose ICMP type is 3 may be different from the expected result.

↘ Implicit "Deny All Traffic" Rule Statement

At the end of every IP ACL is an implicit "deny all traffic" rule statement. Therefore, if a packet does not match any rule, the packet will be denied.

For example:

```
access-list 1 permit host 192.168.4.12
```

This ACL permits only packets sent from the source host 192.168.4.12, and denies packets sent from all other hosts. This is because the following statement exists at the end of this ACL: **access-list 1 deny any**.

If the ACL contains only the following statement:

```
access-list 1 deny host 192.168.4.12
```

Packets sent from any host will be denied when passing through this port.

- ❗ When defining an ACL, you must consider the routing update packets. As the implicit "deny all traffic" statement exists at the end of an ACL, all routing update packets may be blocked.

↘ Input Sequence of Rule Statements

Every new rule is added to the end of an ACL and in front of the default rule statement. The input sequence of statements in an ACL is very important. It determines the priority of each statement in the ACL. When determining whether to forward or block packets, a device compares packets with rule statements based on the sequence that rule statements are created. After locating a matched rule statement, the device does not check any other rule statement.

If a rule statement is created and denies all traffic, all subsequent statements will not be checked.

For example:

```
access-list 101 deny ip any any
access-list 101 permit tcp 192.168.12.0 0.0.0.255 eqtelnetany
```

The first rule statement denies all IP packets. Therefore, Telnet packets from the host on the network 192.168.12.0/24 will be denied. After the device finds that packets match the first rule statement, it does not check the subsequent rule statements any more.

Related Configuration

▾ Configuring an IP ACL

By default, no IP ACL is configured on a device.

Run the **ip access-list { standard | extended } {acl-name | acl-id}** command in global configuration mode to create a standard or an extended IP ACL and enter standard or extended IP ACL mode.

▾ Adding ACEs to an IP ACL

By default, a newly created IP ACL contains an implicit ACE that denies all IPv4 packets. This ACE is hidden from users, but takes effect when the ACL is applied to an interface. That is, all IPv4 packets will be discarded. Therefore, if you want the device to receive or send some specific IPv4 packets, add some ACEs to the ACL.

For a standard IP ACL, add ACEs as follows:

- No matter whether the standard IP ACL is a named or number ACL, you can run the following command in standard IP ACL mode to add an ACE:
`[sn] { permit | deny } {hostsource| any | sourcesource-wildcard} [time-range time-range-name]`
- For a numbered standard IP ACL, you can also run the following command in global configuration mode to add an ACE:
`access-list acl-id { permit | deny } {hostsource| any | sourcesource-wildcard} [time-range tm-rng-name]`

For an extended IP ACL, you can add ACEs as follows:

- No matter whether the extended IP ACL is a named or numbered ACL, you can run the following command in extended IP ACL mode to add an ACE:
`[sn] { permit | deny } protocol {hostsource| any | sourcesource-wildcard} {hostdestination | any | destination destination-wildcard} [[precedence precedence [tos tos]] | dscp dscp] [fragment] [time-range time-range-name]`
- For a numbered extended IP ACL, you can also run the following command in global configuration mode to add an ACE:
`access-list acl-id { permit | deny } protocol {hostsource| any | sourcesource-wildcard} {hostdestination | any | destination destination-wildcard} [[precedence precedence [tos tos]] | dscp dscp] [fragment] [time-range time-range-name]`

▾ Applying an IP ACL

By default, the IP ACL is not applied to any interface/VXLAN, that is, the IP ACL does not filter incoming or outgoing IP packets of the device.

Run the **ip access-group { acl-id | acl-name } { in | out }[reflect]** command in interface/VXLAN configuration mode to apply a standard or an extended IP ACL to a specified interface/VXLAN. By default, a reflexive ACL is disabled on a router. You can run the **reflect** command to enable the reflexive ACL. The working principle of the reflexive ACL is as follows:

- a. A temporary ACL is automatically generated based on the L3 and L4 information of the traffic originated by the internal network. The temporary ACL is created according to the following principles: The IP protocol number remains unchanged, the source and destination IP addresses are swapped, and the TCP/UDP source and destination ports are also swapped.
- b. The router allows traffic to enter the internal network only when the L3 and L4 information of the returned traffic exactly matches that of the temporary ACL previously created based on the outgoing traffic.

12.3.2 MAC Extended ACL

The MAC extended ACL implements refined control on incoming and outgoing packets based on the L2 header of packets. You can permit or deny the entry of specific L2 packets to a network, thus protecting network resources against attacks or control users' access to network resources.

Working Principle

Define a series of MAC access rules in the MAC extended ACL, and then apply the ACL to the incoming or outgoing direction of an interface. The device checks whether the incoming or outgoing packets match the rules and accordingly forwards or blocks these packets.

To configure an MAC extended ACL, you must specify a unique name or ID for this ACL to uniquely identify the ACL. The following table lists the range of IDs that identify MAC extended ACLs.

| Protocol | ID Range |
|------------------|----------|
| MAC extended ACL | 700–799 |

Typical rules defined in an MAC extended ACL include:

- Source MAC address
- Destination MAC address
- Ethernet protocol type

The MAC extended ACL (ID range: 700–799) is used to filter packets based on the source or destination MAC address and the Ethernet type in the packets.

For an individual MAC extended ACL, multiple independent ACL statements can be used to define multiple rules. All statements reference the same ID or name so that these statements are bound with the same ACL. However, more statements mean that it is increasingly difficult to read and understand the ACL.

- ✔ If ACEs in an MAC extended ACL are not defined specifically for IPv6 packets, that is, the Ethernet type is not specified or the value of the Ethernet type field is not 0x86dd, the MAC extended ACL does not filter IPv6 packets. If you want to filter IPv6 packets, use the IPv6 extended ACL.

⚡ Implicit "Deny All Traffic" Rule Statement

At the end of every MAC extended ACL is an implicit "deny all traffic" rule statement. Therefore, if a packet does not match any rule, the packet will be denied.

For example:

```
access-list 700 permit host 00d0.f800.0001 any
```

This ACL permits only packets from the host with the MAC address 00d0.f800.0001, and denies packets from all other hosts. This is because the following statement exists at the end of this ACL: **access-list 700 deny any any**.

Related Configuration

📄 Configuring an MAC Extended ACL

By default, no MAC extended ACL is configured on a device.

Run the **mac access-list extended {acl-name | acl-id}** command in global configuration mode to create an MAC extended ACL and enter MAC extended ACL mode.

📄 Adding ACEs to an MAC Extended ACL

By default, a newly created MAC extended ACL contains an implicit ACE that denies all L2 packets. This ACE is hidden from users, but takes effect when the ACL is applied to an interface. That is, all L2 packets will be discarded. Therefore, if you want the device to receive or send some specific L2 packets, add some ACEs to the ACL.

You can add ACEs to an MAC extended ACL as follows:

- No matter whether the MAC extended ACL is a named or numbered ACL, you can run the following command in MAC extended ACL mode to add an ACE:

```
[sn] { permit | deny } {any | host src-mac-addr }{any | host dst-mac-addr } [ethernet-type] [coscos ] [innercos]  
[ time-range tm-rng-name ]
```

- For a numbered MAC extended ACL, you can also run the following command in global configuration mode to add an ACE:

```
access-list acl-id { permit | deny } {any | host src-mac-addr }{any | host dst-mac-addr } [ethernet-type] [coscos ]  
[innercos] [ time-range time-range-name ]
```

📄 Applying an MAC Extended ACL

By default, the MAC extended ACL is not applied to any interface, that is, the created MAC extended ACL does not filter incoming or outgoing L2 packets of a device.

Run the **mac access-group { acl-id | acl-name } { in | out }** command in interface/VXLAN configuration mode to apply an MAC extended ACL to a specified interface/VXLAN.

12.3.3 Expert Extended ACL

You can create an expert extended ACL to match the L2 and L3 information in packets using the same rule. The expert extended ACL can be treated as a combination and enhancement of the IP ACL and the MAC extended ACL because the expert extended ACL can contain ACEs in both the IP ACL and the MAC extended ACL. In addition, the VLAN ID can be specified in the expert extended ACL to filter packets.

Working Principle

Define a series of access rules in the expert extended ACL, and then apply the ACL in the incoming or outgoing direction of an interface. The device checks whether incoming or outgoing packets match the rules and accordingly forwards or blocks these packets.

To configure an expert extended ACL, you must specify a unique name or ID for this ACL so that the protocol can uniquely identify each ACL. The following table lists the ID range of the expert extended ACL.

| Protocol | ID Range |
|---------------------|-----------|
| Expert extended ACL | 2700–2899 |

When an expert extended ACL is created, defined rules can be applied to all packets. The device determines whether to forward or block packets by checking whether packets match these rules.

Typical rules defined in an expert extended ACL include:

- All information in the basic ACL and MAC extended ACL
- VLAN ID

The expert extended ACL (ID range: 2700–2899) is a combination of the basic ACL and MAC extended ACL, and can filter packets based on the VLAN ID.

For an individual expert extended ACL, multiple independent statements can be used to define multiple rules. All statements reference the same ID or name so that these statements are bound with the same ACL.

- ✔ If rules in an expert extended ACL are not defined specifically for IPv6 packets, that is, the Ethernet type is not specified or the value of the Ethernet type field is not 0x86dd, the expert extended ACL does not filter IPv6 packets. If you want to filter IPv6 packets, use the IPv6 extended ACL.

↳ Implicit "Deny All Traffic" Rule Statement

At the end of every expert extended ACL is an implicit "deny all traffic" rule statement. Therefore, if a packet does not match any rule, the packet will be denied.

For example:

```
access-list 2700 permit 0x0806 any any any any any
```

This ACL permits only ARP packets whose Ethernet type is 0x0806, and denies all other types of packets. This is because the following statement exists at the end of this ACL: **access-list 2700 deny any any any any**.

Related Configuration

↳ Configuring an Expert Extended ACL

By default, no expert extended ACL is configured on a device.

Run the **expert access-list extended {acl-name | acl-id}** command in global configuration mode to create an expert extended ACL and enter expert extended ACL mode.

↳ Adding ACEs to an Expert Extended ACL

By default, a newly created expert extended ACL contains an implicit ACE that denies all packets. This ACE is hidden from users, but takes effect when the ACL is applied to an interface. That is, all L2 packets will be discarded. Therefore, if you want the device to receive or send some specific L2 packets, add some ACEs to the ACL.

You can add ACEs to an expert extended ACL as follows:

- No matter whether the expert extended ACL is a named or numbered ACL, you can run the following command in expert extended ACL mode to add an ACE:

```
[sn] { permit | deny } [ protocol [ ethernet-type ] [ cos [ out ] [ inner in ] ] ] [ [ VID [ out ] [ inner in ] ] ]
{ source source-wildcard | host source | any } { host source-mac-address | any } { destination destination-wildcard |
host destination | any } { host destination-mac-address | any } [ precedence precedence ] [ tos tos ] [ fragment ]
[ range lower upper ] [ time-range time-range-name ]]
```

- For a numbered expert extended ACL, you can also run the following command in expert extended ACL mode to add an ACE:

```
access-list acl-id { permit | deny } [ protocol [ ethernet-type ] [ cos [ out ] [ inner in ] ] ] [ [ VID [ out ] [ inner in ] ] ]
{ source source-wildcard | host source | any } { host source-mac-address | any } { destination destination-wildcard |
host destination | any } { host destination-mac-address | any } [ precedence precedence ] [ tos tos ] [ fragment ]
[ range lower upper ] [ time-range time-range-name ]]
```

▾ Applying an Expert Extended ACL

By default, the expert extended ACL is not applied to any interface, that is, the created expert extended ACL does not filter incoming or outgoing L2 or L3 packets of a device.

Run the **expert access-group { acl-id | acl-name } { in | out }** command in interface/VXLAN configuration mode to apply an expert extended ACL to a specified interface/VXLAN.

12.3.4 IPv6 ACL

The IPv6 ACL implements refined control on incoming and outgoing IPv6 packets of a device. You can permit or deny the entry of specific IPv6 packets to a network according to actual requirements to control access of IPv6 users to network resources.

Working Principle

Define a series of IPv6 access rules in the IPv6 ACL, and then apply the ACL in the incoming or outgoing direction of an interface. The device checks whether the incoming or outgoing IPv6 packets match the rules and accordingly forwards or blocks these packets.

To configure an IPv6 ACL, you must specify a unique name for this ACL.

- ❗ Unlike the IP ACL, MAC extended ACL, and expert extended ACL, you can specify only a name but not an ID for the IPv6 ACL created.
- ❗ Only one IP ACL, or one MAC extended ACL, or one expert extended ACL can be applied to the incoming or outgoing direction of an interface. Besides, one more IPv6 ACL can be applied.

↳ Implicit "Deny All Traffic" Rule Statement

At the end of every IPv6 ACL is an implicit "deny all IPv6 traffic" rule statement. Therefore, if a packet does not match any rule, the packet will be denied.

For example:

```
ipv6 access-list ipv6_acl
 10 permit ipv6 host 200::1 any
```

This ACL permits only IPv6 packets from the source host 200::1, and denies IPv6 packets from all other hosts. This is because the following statement exists at the end of this ACL: deny ipv6 any any.

! Although the IPv6 ACL contains the implicit "deny all IPv6 traffic" rule statement by default, it does not filter ND packets.

↳ Input Sequence of Rule Statements

Every new rule is added to the end of an ACL and in front of the default rule statement. The input sequence of statements in an ACL is very important. It determines the priority of each statement in the ACL. When determining whether to forward or block packets, a device compares packets with rule statements based on the sequence that rule statements are created. After locating a matched rule statement, the device does not check any other rule statement.

If a rule statement is created and permits all IPv6 traffic, all subsequent statements will not be checked.

For example:

```
ipv6 access-list ipv6_acl
 10 permit ipv6 any any
 20 deny ipv6 host 200::1 any
```

As the first rule statement permits all IPv6 packets, all IPv6 packets sent from the host 200::1 does not match the subsequent deny rule with the serial number of 20, and therefore will not be denied. After the device finds that packets match the first rule statement, it does not check the subsequent rule statements any more.

Related Configuration

↳ Configuring an IPv6 ACL

By default, no IPv6 ACL is configured on a device.

Run the **ipv6 access-list *acl-name*** command in global configuration mode to create an IPv6 ACL and enter IPv6 ACL mode.

↳ Adding ACEs to an IPv6 ACL

By default, a newly created IPv6 ACL contains an implicit ACE that denies all IPv6 packets. This ACE is hidden from users, but takes effect when the ACL is applied to an interface. That is, all IPv6 packets will be discarded. Therefore, if you want the device to receive or send some specific IPv6 packets, add some ACEs to the ACL.

Run the following command in IPv6 ACL mode to add an ACE:

```
[sn] {permit | deny } protocol{src-ipv6-prefix/prefix-len | hostsrc-ipv6-addr | any} {dst-ipv6-pfx/pfx-len | host dst-ipv6-addr | any} [range/lower upper] [dscpdscp] [flow-label flow-label] [fragment] [time-range tm-mg-name][log]
```

📌 Applying an IPv6 ACL

By default, the IPv6 ACL is not applied to any interface, that is, the IPv6 ACL does not filter incoming or outgoing IPv6 packets of a device.

Run the **ipv6 traffic-filter *acl-name* { in| out }** command in interface/VXLAN configuration mode to apply an IPv6 ACL to a specified interface/VXLAN.

12.3.5 Security Channel

In some application scenarios, packets meeting some characteristics may need to bypass the checks of access control applications. For example, before DOT1X authentication, users are allowed to log in to a specified website to download the DOT1X authentication client. The security channel can be used for this purpose. When the security channel configuration command is executed to apply a secure ACL globally or to an interface or VXLAN, this ACL becomes a security channel.

Working Principle

The security channel is also an ACL, and can be configured globally or for a specified interface or VXLAN. When arriving at an interface, packets are checked on the security channel. If meeting the matching conditions of the security channel, packets directly enter a switch without undergoing the access control, such as port security, Web authentication, 802.1x, and IP+MAC binding check. A globally applied security channel takes effect on all interfaces except exclusive interfaces.

- ❗ The deny ACEs in an ACL that is applied to a security channel do not take effect. In addition, this ACL does not contain an implicit "deny all traffic" rule statement at the end of the ACL. If packets do not meet matching conditions of the security channel, they are checked according to the access control rules in compliance with the relevant process.
- ❗ You can configure up to eight exclusive interfaces for the global security channel. In addition, you cannot configure interface-based security channel on these exclusive interfaces.
- ❗ If a security channel is applied to an interface while a global security channel exists, this global security channel does not take effect on this interface.
- ❗ If both port-based migratable authentication mode and security channel are applied to an interface, the security channel does not take effect.
- ❗ An IPv6 ACL cannot be configured as a security channel.
- ❗ Only switches support the security channel.

Related Configuration

📌 Configuring an ACL

Before configuring the security channel, configure an ACL. For details about how to configure an ACL, see the earlier descriptions about ACL configuration.

📌 Adding ACEs to an ACL

For details about how to add ACEs to an ACL, see the earlier descriptions about the IP ACL, MAC extended ACL, or expert extended ACL.

▾ [Configuring a VXLAN Security Channel](#)

By default, no VXLAN security channel is configured on a device.

Run the **security access-group** {*acl-id* | *acl-name*} command in VXLAN configuration mode to configure a VXLAN security channel.

▾ [Configuring a Global Security Channel](#)

By default, no global security channel is configured on a device.

Run the **security global access-group** {*acl-id* | *acl-name*} command in global configuration mode to configure a global security channel.

▾ [Configuring an Exclusive Interface for the Global Security Channel](#)

By default, no exclusive interface is configured for the global security channel on a device.

Run the **security uplink enable** command in interface configuration mode to configure a specified interface as the exclusive interface of the global security channel.

12.3.6 SVI Router ACL

By default, an ACL that is applied to an SVI also takes effect on L2 packets forwarded within a VLAN and L3 packets forwarded between VLANs. Consequently, users in the same VLAN may fail to communicate with each other. Therefore, a switchover method is provided so that the ACL that is applied to an SVI takes effect only on routing packets between VLANs.

[Working Principle](#)

By default, the SVI router ACL function is disabled, and an SVI ACL takes effect on L3 packets forwarded between VLANs and L2 packets forwarded within a VLAN. After the SVI router ACL function is enabled, the SVI ACL takes effect only on L3 packets forwarded between VLANs.

[Related Configuration](#)

▾ [Configuring an ACL](#)

Before configuring the SVI router ACL, configure and apply an ACL. For details about how to configure an ACL, see the earlier descriptions about ACL configuration.

▾ [Adding ACEs to an ACL](#)

For details about how to add ACEs to an ACL, see the earlier descriptions about the IP ACL, MAC extended ACL, expert extended ACL, or IPv6 ACL.



▾ [Applying an ACL](#)



For details about how to apply an ACL, see the earlier descriptions about the IP ACL, MAC extended ACL, expert extended ACL, or IPv6 ACL. Apply the ACL in SVI configuration mode.

📌 [Configuring the SVI Router ACL](#)

Run the **svi router-acls enable** command in global configuration mode to enable the SVI router ACL so that the ACL that is applied to an SVI takes effect only on packets forwarded at L3, and not on packets forwarded at L2 within a VLAN.

12.4 Configuration

| Configuration Item | Description and Command | |
|--|--|--|
| Configuring an IP ACL |  (Optional) It is used to filter IPv4 packets. | |
| | ip access-list standard | Configures a standard IP ACL. |
| | ip access-list extended | Configures an extended IP ACL. |
| | permit host any time-range | Adds a permit ACE to a standard IP ACL. |
| | deny host any time-range | Adds a deny ACE to a standard IP ACL. |
| | permit host any host any tos dscp precedence fragment time-range | Adds a permit ACE to an extended IP ACL. |
| | deny host any host any tos dscp precedence fragment time-range | Adds a deny ACE to an extended IP ACL. |
| | ip access-group in out | Applies a standard or an extended IP ACL. |
| Configuring an MAC Extended ACL |  (Optional) It is used to filter L2 packets. | |
| | mac access-list extended | Configures an MAC extended ACL. |
| | permit any host any host cos inner time-range | Adds a permit ACE to an MAC extended ACL. |
| | deny any host any host cos inner time-range | Adds a deny ACE to an MAC extended ACL. |
| Configuring an Expert Extended ACL |  (Optional) It is used to filter L2 and L3 packets. | |
| | expert access-list extended | Configures an expert extended ACL. |
| | permit cos inner VID inner host any host any host any precedence tos fragment range time-range | Adds a permit ACE to an expert extended ACL. |
| | deny cos inner VID inner host any host any host any precedence tos fragment range time-range | Adds a deny ACE to an expert extended ACL. |
| | expert access-group in out | Applies an expert extended ACL. |

| Configuration Item | Description and Command | |
|--|---|--|
| Configuring an IPv6 Extended ACL |  (Optional) It is used to filter IPv6 packets. | |
| | ipv6 access-list | Configures an IPv6 ACL. |
| | permit host any host any range dscp flow-label fragment time-range | Adds a permit ACE to an IPv6 ACL. |
| | deny host any host any range dscp flow-label fragment time-range | Adds a deny ACE to an IPv6 ACL. |
| | ipv6 traffic-filter in out | Applies an IPv6 ACL. |
| Configuring a Security Channel |  (Optional) It is used to enable packets meeting some characteristics to bypass the checks of access control applications, such as the DOT1X and Web authentication. | |
| | security access-group | Enables the security channel in interface configuration mode. |
| | security global access-group | Enables the security channel in global configuration mode. |
| | security uplink enable | Configures an interface as the exclusive interface of the global security channel in interface configuration mode. |
| Configuring Comments for ACLs |  (Optional) It is used to configure comments for an ACL or ACE so that users can easily identify the functions of the ACL or ACE. | |
| | list-remark | Configures a comment for an ACL in ACL configuration mode. |
| | access-list list-remark | Configures a comment for an ACL in global configuration mode. |
| | remark | Configures a comment for an ACE in ACL configuration mode. |

12.4.1 Configuring an IP ACL

Configuration Effect

Configure and apply an IP ACL to an interface/VXLAN to control all incoming and outgoing IPv4 packets of this interface/VXLAN. You can permit or deny the entry of specific IPv4 packets to a network to control access of IP users to network resources.

Notes

N/A

Configuration Steps

📌 [Configuring an IP ACL](#)

- (Mandatory) Configure an IP ACL if you want to control access of IPv4 users to network resources.
- You can configure this ACL on an access, an aggregate, or a core device based on the distribution of users. The IP ACL takes effect only on the local device, and does not affect other devices on the network.

➤ Adding ACEs to an IP ACL

- (Optional) An ACL may contain zero or multiple ACEs. If no ACE is configured, all incoming IPv4 packets of the device are denied by default.

➤ Applying an IP ACL

- (Mandatory) Apply an IP ACL to a specified interface/VXLAN if you want this ACL take effect.
- You can apply an IP ACL on a specified interface/VXLAN of an access, an aggregate, or a core device based on the distribution of users.

Verification

- Use the following methods to verify the configuration effects of the IP ACL:
- Run the **ping** command to verify that the IP ACL takes effect on the specified interface. For example, if an IP ACL is configured to prohibit a host with a specified IP address or hosts in a specified IP address range from accessing the network, run the **ping** command to verify that the host(s) cannot be successfully pinged.
- Access related network resources to verify that the IP ACL takes effect on the specified interface. For example, access the Internet or access the FTP resources on the network through FTP.

Related Commands

➤ Configuring an IP ACL

| | |
|------------------------------|--|
| Command | ip access-list { standard extended } {acl-name acl-id } |
| Parameter Description | <p>standard: Indicates that a standard IP ACL is created.</p> <p>extended: Indicates that an extended IP ACL is created.</p> <p><i>acl-name:</i> Indicates the name of a standard or an extended IP ACL. If this option is configured, a named ACL is created. The name is a string of 1 to 99 characters. The ACL name cannot start with numbers (0–9), "in", or "out".</p> <p><i>acl-id:</i> Indicates the ID that uniquely identifies a standard or extended IP ACL. If this option is configured, a numbered ACL is created. If a standard IP ACL is created, the value range of <i>acl-id</i> is 1–99 and 1300–1999. If an extended IP ACL is created, the value range of <i>acl-id</i> is 100–199 and 2000–2699.</p> |
| Command Mode | Configuration mode |
| Usage Guide | Run this command to configure a standard or an extended IP ACL and enter standard or extended IP ACL configuration mode. If you want to control access of users to network resources by checking the source IP address of each packet, configure a standard IP ACL. If you want to control access of users to network resources by checking the source or destination IP address, protocol number, and TCP/UDP source or destination port, configure an extended IP ACL. |

➤ Adding ACEs to an IP ACL

- Add ACEs to a standard IP ACL.

Use either of the following methods to add ACEs to a standard IP ACL:

| | |
|------------------------------|---|
| Command | [<i>sn</i>] { permit deny } { host <i>source</i> any <i>source source-wildcard</i> } [time-range <i>time-range-name</i>] |
| Parameter Description | <p><i>sn</i>: Indicates the sequence number of an ACE. The value ranges from 1 to 2,147,483,647. This sequence number determines the priority of this ACE in the ACL. A smaller sequence number indicates a higher priority. An ACE with a higher priority will be preferentially used to match packets. If you do not specify the sequence number when adding an ACE, the system automatically allocates a sequence number, which is equal to an increment (10 by default) plus the sequence number of the last ACE in the current ACL. For example, if the sequence number of the last ACE is 100, the sequence number of a newly-added ACE will be 110 by default. You can adjust the increment using a command.</p> <p>permit: Indicates that the ACE is a permit ACE.</p> <p>deny: Indicates that the ACE is a deny ACE.</p> <p>host source: Indicates that IP packets sent from a host with the specified source IP address are filtered.</p> <p>any: Indicates that IP packets sent from any host are filtered.</p> <p><i>source source-wildcard</i>: Indicates that IP packets sent from hosts in the specified IP network segment are filtered.</p> <p>time-range time-range-name: Indicates that this ACE is associated with a time range. The ACE takes effect only within this time range. For details about the time range, see the configuration manual of the time range.</p> |
| Command Mode | Standard IP ACL configuration mode |
| Usage Guide | Run this command to add ACEs in standard IP ACL configuration mode. The ACL can be a named or numbered ACL. |

| | |
|------------------------------|---|
| Command | access-list <i>acl-id</i> { permit deny } { host <i>source</i> any <i>source source-wildcard</i> } [time-range <i>tm-rng-name</i>] |
| Parameter Description | <p><i>acl-id</i>: Indicates the ID of a numbered ACL. It uniquely identifies an ACL. The value range of <i>acl-id</i> is 100–199 and 1300–1999.</p> <p>permit: Indicates that the ACE is a permit ACE.</p> <p>deny: Indicates that the ACE is a deny ACE.</p> <p>host source: Indicates that IP packets sent from a host with the specified source IP address are filtered.</p> <p>any: Indicates that IP packets sent from any host are filtered.</p> <p><i>source source-wildcard</i>: Indicates that IP packets sent from hosts in the specified IP network segment are filtered.</p> <p>time-range time-range-name: Indicates that this ACE is associated with a time range. The ACE takes effect only within this time range. For details about the time range, see the configuration manual of the time range.</p> |
| Command Mode | Standard IP ACL configuration mode |
| Usage Guide | Run this command to add ACEs to a numbered IP ACL in global configuration mode. It cannot be used to |

| | |
|--|-----------------------------|
| | add ACEs to a named IP ACL. |
|--|-----------------------------|

- Add ACEs to an extended IP ACL.

Use either of the following methods to add ACEs to an extended IP ACL:

| | |
|------------------------------|---|
| Command | [<i>sn</i>] { permit deny } <i>protocol</i> { host <i>source</i> any <i>source source-wildcard</i> } { host <i>destination</i> any <i>destination destination-wildcard</i> } [[precedence <i>precedence</i> [tos <i>tos</i>]] dscp <i>dscp</i>] [fragment] [time-range <i>time-range-name</i>] |
| Parameter Description | <p><i>sn</i>: Indicates the sequence number of an ACE. The value ranges from 1 to 2,147,483,647. This sequence number determines the priority of this ACE in the ACL. A smaller sequence number indicates a higher priority. An ACE with a higher priority will be preferentially used to match packets. If you do not specify the sequence number when adding an ACE, the system automatically allocates a sequence number, which is equal to an increment (10 by default) plus the sequence number of the last ACE in the current ACL. For example, if the sequence number of the last ACE is 100, the sequence number of a newly-added ACE will be 110 by default. You can adjust the increment using a command.</p> <p>permit: Indicates that the ACE is a permit ACE.</p> <p>deny: Indicates that the ACE is a deny ACE.</p> <p><i>protocol</i>: Indicates the IP protocol number. The value ranges from 0 to 255. To facilitate the use, the system provides frequently-used abbreviations to replace the specific IP protocol numbers, including eigrp, gre, icmp, igmp, ip, ipinip, nos, ospf, tcp, and udp.</p> <p>host source: Indicates that IP packets sent from a host with the specified source IP address are filtered.</p> <p><i>source source-wildcard</i>: Indicates that IP packets sent from hosts in the specified IP network segment are filtered.</p> <p>host destination: Indicates that IP packets sent to a host with the specified destination IP address are filtered. If the any keyword is configured, IP packets sent to any host are filtered.</p> <p><i>destination destination-wildcard</i>: Indicates that IP packets sent to hosts in a specified IP network segment are filtered.</p> <p>any: Indicates that IP packets sent to or from any host are filtered.</p> <p>precedence precedence: Indicates that IP packets with the specified precedence field in the header are filtered.</p> <p>tos tos: Indicates that IP packets with the specified the type of service (TOS) field in the header are filtered.</p> <p>dscp dscp: Indicates that IP packets with the specified the dscp field in the header are filtered.</p> <p>fragment: Indicates that only fragmented IP packets except the first fragments are filtered.</p> <p>time-range time-range-name: Indicates that this ACE is associated with a time range. The ACE takes effect only within this time range. For details about the time range, see the configuration manual of the time range.</p> |
| Command Mode | Extended IP ACL configuration mode |
| Usage Guide | Run this command to add ACEs in extended IP ACL configuration mode. The ACL can be a named or numbered ACL. |

| | |
|----------------|--|
| Command | access-list <i>acl-id</i> { permit deny } <i>protocol</i> { host <i>source</i> any <i>source source-wildcard</i> } { host <i>destination</i> |
|----------------|--|

| | |
|------------------------------|---|
| | any <i>destination destination-wildcard</i> } [[precedence <i>precedence</i> [tos <i>tos</i>]] dscp <i>dscp</i>] [fragment] [time-range <i>time-range-name</i>] |
| Parameter Description | <p><i>acl-id</i>: Indicates the ID of a numbered ACL. It uniquely identifies an ACL. The value range of <i>acl-id</i> is 100–199 and 2000–1999.</p> <p><i>sn</i>: Indicates the sequence number of an ACE. The value ranges from 1 to 2,147,483,647. This sequence number determines the priority of this ACE in the ACL. A smaller sequence number indicates a higher priority. An ACE with a higher priority will be preferentially used to match packets. If you do not specify the sequence number when adding an ACE, the system automatically allocates a sequence number, which is equal to an increment (10 by default) plus the sequence number of the last ACE in the current ACL. For example, if the sequence number of the last ACE is 100, the sequence number of a newly-added ACE will be 110 by default. You can adjust the increment using a command.</p> <p>permit: Indicates that the ACE is a permit ACE.</p> <p>deny: Indicates that the ACE is a deny ACE.</p> <p><i>protocol</i>: Indicates the IP protocol number. The value ranges from 0 to 255. To facilitate the use, the system provides frequently-used abbreviations to replace the specific IP protocol numbers, including eigrp, gre, icmp, igmp, ip, ipinip, nos, ospf, tcp, and udp.</p> <p>host source: Indicates that IP packets sent from a host with the specified source IP address are filtered.</p> <p><i>source source-wildcard</i>: Indicates that IP packets sent from hosts in the specified IP network segment are filtered.</p> <p>host destination: Indicates that IP packets sent to a host with the specified destination IP address are filtered. If the any keyword is configured, IP packets sent to any host are filtered.</p> <p><i>destination destination-wildcard</i>: Indicates that IP packets sent to hosts in a specified IP network segment are filtered.</p> <p>any: Indicates that IP packets sent to or from any host are filtered.</p> <p>precedence <i>precedence</i>: Indicates that IP packets with the specified precedence field in the header are filtered.</p> <p>tos <i>tos</i>: Indicates that IP packets with the specified the type of service (TOS) field in the header are filtered.</p> <p>dscp <i>dscp</i>: Indicates that IP packets with the specified the dscp field in the header are filtered.</p> <p>fragment: Indicates that only fragmented IP packets except the first fragments are filtered.</p> <p>time-range <i>time-range-name</i>: Indicates that this ACE is associated with a time range. The ACE takes effect only within this time range. For details about the time range, see the configuration manual of the time range.</p> |
| Command Mode | Extended IP ACL configuration mode |
| Usage Guide | Run this command to add ACEs to a numbered IP ACL in extended IP ACL configuration mode. It cannot be used to add ACEs to a named extended IP ACL. |

📌 Applying an IP ACL

| | |
|------------------------------|--|
| Command | ip access-group { <i>acl-id</i> <i>acl-name</i> } { in out } [reflect] |
| Parameter Description | <p><i>acl-id</i>: Indicates that a numbered standard or extended IP ACL will be applied to the interface.</p> <p><i>acl-name</i>: Indicates that a named standard or extended IP ACL will be applied to the interface.</p> |

| | |
|---------------------|--|
| | <p>in: Indicates that this ACL controls incoming IP packets of the interface.</p> <p>out: Indicates that this ACL controls outgoing IP packets of the interface.</p> <p>reflect: Indicates that the reflexive ACL is enabled.</p> |
| Command Mode | Interface configuration mode |
| Usage Guide | This command makes an IP ACL take effect on the incoming or outgoing packets of a specified interface/VXLAN. |

Configuration Example

i The following configuration example describes only ACL-related configurations.

Configuring an IP ACL to Prohibit Departments Except the Financial Department from Accessing the Financial Data Server

| | |
|--|---|
| <p>Scenario Figure 12-3</p> | |
| <p>Configuration Steps</p> | <ul style="list-style-type: none"> ● Configure an IP ACL. ● Add ACEs to the IP ACL. ● Apply the IP ACL to the outgoing direction of the interface connecting the financial data server. |
| <p>SW1</p> | <pre>sw1(config)#ip access-list standard 1 sw1(config-std-nacl)#permit 10.1.1.0 0.0.0.255 sw1(config-std-nacl)#deny 11.1.1.1 0.0.0.255 sw1(config-std-nacl)#exit sw1(config)#int gigabitEthernet 0/3 sw1(config-if-GigabitEthernet 0/3)#ip access-group 1 out</pre> |
| <p>Verification</p> | <ul style="list-style-type: none"> ● On a PC of the R&D department, ping the financial data server. Verify that the ping operation fails. ● On a PC of the financial department, ping the financial data server. Verify that the ping operation |

| | |
|------------|---|
| | succeeds. |
| SW1 | <pre>sw1(config)#show access-lists ip access-list standard 1 10 permit 10.1.1.0 0.0.0.255 20 deny 11.1.1.0 0.0.0.255 sw1(config)#show access-group ip access-group 1 out Applied On interface GigabitEthernet 0/3</pre> |

12.4.2 Configuring an MAC Extended ACL

Configuration Effect

Configure and apply an MAC extended ACL to an interface/VXLAN to control all incoming and outgoing IPv4 packets of this interface/VXLAN. You can permit or deny the entry of specific L2 packets to a network to control access of users to network resources based on L2 packets.

Notes

N/A

Configuration Steps

📌 Configuring an MAC Extended ACL

- (Mandatory) Configure an MAC extended ACL if you want to control users' access to network resources based on the L2 packet header, for example, the MAC address of each user's PC.
- You can configure this ACL on an access, an aggregate, or a core device based on the distribution of users. The MAC extended ACL takes effect only on the local device, and does not affect other devices on the network.

📌 Adding ACEs to an MAC Extended ACL

- (Optional) An ACL may contain zero or multiple ACEs. If no ACE is configured, all incoming L2 Ethernet packets of the device are denied by default.

📌 Applying an MAC extended ACL

- (Mandatory) Apply an MAC extended ACL to a specified interface if you want this ACL take effect.
- You can apply an MAC extended ACL on a specified interface of an access, an aggregate, or a core device based on the distribution of users.

Verification

- Use the following methods to verify the configuration effects of the MAC extended ACL:
- If an MAC extended ACL is configured to permit or deny some IP packets, run the **ping** command to check whether ACEs of this ACL takes effect on the specified interface. For example, an MAC extended ACL is configured to prevent a device interface from receiving IP packets (Ethernet type is 0x0800), run the **ping** command for verification.
- If an MAC extended ACL is configured to permit or deny some non-IP packets (e.g. ARP packets), also run the **ping** command to check whether ACEs of this ACL takes effect on the specified interface. For example, to filter out ARP packets, run the **ping** command for verification.
- You can also construct L2 packets meeting some specified characteristics to check whether the MAC extended ACL takes effect. Typically, prepare two PCs, construct and send L2 packets on one PC, enable packet capturing on another PC, and check whether packets are forwarded as expected (forwarded or blocked) according to the action specified in the ACEs.

Related Commands

▾ Configuring an MAC Extended ACL

| | |
|------------------------------|--|
| Command | mac access-list extended { <i>acl-name</i> <i>acl-id</i> } |
| Parameter Description | <i>acl-name</i> : Indicates the name of an MAC extended ACL. If this option is configured, a named ACL is created. The name is a string of 1 to 99 characters. The ACL name cannot start with numbers (0–9), "in", or "out". <i>acl-id</i> : Indicates the ID that uniquely identifies an MAC extended ACL. If this option is configured, a numbered ACL is created. The value range of <i>acl-id</i> is 700–799. |
| Command Mode | Configuration mode |
| Usage Guide | Run this command to configure an MAC extended ACL and enter MAC extended ACL configuration mode. You can configure an MAC extended ACL to control users' access to network resources by checking the L2 information of Ethernet packets. |

▾ Adding ACEs to an MAC Extended ACL

Use either of the following methods to add ACEs to an MAC extended ACL:

- Add ACEs in MAC extended ACL configuration mode.

| | |
|------------------------------|--|
| Command | [<i>sn</i>] { permit deny } { any host <i>src-mac-addr</i> } { any host <i>dst-mac-addr</i> } [<i>ethernet-type</i>] [cos <i>cos</i> [inner <i>cos</i>]] [time-range <i>tm-rng-name</i>] |
| Parameter Description | <i>sn</i> : Indicates the sequence number of an ACE. The value ranges from 1 to 2,147,483,647. This sequence number determines the priority of this ACE in the ACL. A smaller sequence number indicates a higher priority. An ACE with a higher priority will be preferentially used to match packets. If you do not specify the sequence number when adding an ACE, the system automatically allocates a sequence number, which is equal to an increment (10 by default) plus the sequence number of the last ACE in the current ACL. For example, if the sequence number of the last ACE is 100, the sequence number of a newly-added ACE will |

| | |
|---------------------|---|
| | <p>be 110 by default. You can adjust the increment using a command.</p> <p>permit: Indicates that the ACE is a permit ACE.</p> <p>deny: Indicates that the ACE is a deny ACE.</p> <p>any: Indicates that L2 packets sent from any host are filtered.</p> <p>host <i>src-mac-addr</i>: Indicates that IP packets sent from a host with the specified source MAC address are filtered.</p> <p>any: Indicates that L2 packets sent to any host are filtered.</p> <p>host <i>dst-mac-addr</i>: Indicates that IP packets sent to a host with the specified destination MAC address are filtered.</p> <p>ethernet-type: Indicates that L2 packets of the specified Ethernet type are filtered.</p> <p>cos <i>cos</i>: Indicates that L2 packets with the specified class of service (cos) field in the outer tag are filtered.</p> <p>inner <i>cos</i>: Indicates that L2 packets with the specified cos field in the inner tag are filtered.</p> <p>time-range <i>time-range-name</i>: Indicates that this ACE is associated with a time range. The ACE takes effect only within this time range. For details about the time range, see the configuration manual of the time range.</p> |
| Command Mode | MAC extended ACL configuration mode |
| Usage Guide | Run this command to add ACEs in MAC extended ACL configuration mode. The ACL can be a named or numbered ACL. |

- Add ACEs to an MAC extended ACL in global configuration mode.

| | |
|------------------------------|---|
| Command | access-list <i>acl-id</i> { permit deny } {any host <i>src-mac-addr</i> } {any host <i>dst-mac-addr</i> } [<i>ethernet-type</i>] [cos <i>cos</i> [inner <i>cos</i>]] [time-range <i>tm-rng-name</i>] |
| Parameter Description | <p><i>acl-id</i>: Indicates the ID of a numbered ACL. It uniquely identifies an ACL. The value range of <i>acl-id</i> is 700–799.</p> <p>permit: Indicates that the ACE is a permit ACE.</p> <p>deny: Indicates that the ACE is a deny ACE.</p> <p>host <i>src-mac-addr</i>: Indicates that IP packets sent from a host with the specified source MAC address are filtered.</p> <p>any: Indicates that L2 packets sent to any host are filtered.</p> <p>host <i>dst-mac-addr</i>: Indicates that IP packets sent to a host with the specified destination MAC address are filtered.</p> <p>ethernet-type: Indicates that L2 packets of the specified Ethernet type are filtered.</p> <p>cos <i>cos</i>: Indicates that L2 packets with the specified cos field in the outer tag are filtered.</p> <p>inner <i>cos</i>: Indicates that L2 packets with the specified cos field in the inner tag are filtered.</p> <p>time-range <i>time-range-name</i>: Indicates that this ACE is associated with a time range. The ACE takes effect only within this time range. For details about the time range, see the configuration manual of the time range.</p> |
| Command Mode | Global configuration mode |
| Usage Guide | Run this command to add ACEs to a numbered MAC extended ACL in global configuration mode. It cannot be used to add ACEs to a named MAC extended ACL. |

📌 Applying an MAC Extended ACL

| | |
|---------------------|---|
| Command | <code>mac access-group { acl-id acl-name } { in out }</code> |
| Parameter | <i>acl-id</i> : Indicates that a numbered MAC extended IP ACL will be applied to the interface. |
| Description | <i>acl-name</i> : Indicates that a named MAC extended IP ACL will be applied to the interface. in : Indicates that this ACL controls incoming L2 packets of the interface. out : Indicates that this ACL controls outgoing L2 packets of the interface. |
| Command Mode | Interface configuration mode |
| Usage Guide | This command makes an MAC extended ACL take effect on the incoming or outgoing packets of a specified interface. |

Configuration Example

i The following configuration example describes only ACL-related configurations.

Configuring an MAC Extended ACL to Restrict Resources Accessible by Visitors

| | |
|--|--|
| <p>Scenario Figure 12-4</p> | <p>The diagram shows a central switch SW1 with four interfaces: Gi 0/1, Gi 0/2, Gi 0/3, and Gi 0/4. Gi 0/1 connects to a group of PCs labeled 'Employees' (PC1, PC2). Gi 0/2 connects to a group of PCs labeled 'Visitors' (PC1, PC2). Gi 0/3 connects to a group of servers labeled 'Servers', which includes a 'Financial Data Server' (MAC:00e0.f800.000d) and a 'Public Server' (MAC:00e0.f800.000c). Gi 0/4 connects to an 'Internet' cloud.</p> |
| <p>Configuration Steps</p> | <ul style="list-style-type: none"> ● Configure an MAC extended ACL. ● Add ACEs to the MAC extended ACL. ● Apply the MAC extended ACL to the outgoing direction of the interface connected to the visitor area so that visitors are allowed to access Internet and the public server of the company, but prohibited from accessing the financial data server of the company. That is, visitors cannot access the server with the MAC address 00e0.f800.000d. |
| <p>SW1</p> | <pre>sw1(config)#mac access-list extended 700 sw1(config-mac-nacl)#deny any host 00e0.f800.000d sw1(config-mac-nacl)#permit any any sw1(config-mac-nacl)#exit sw1(config)#int gigabitEthernet 0/2</pre> |

| | |
|---------------------|--|
| | sw1(config-if-GigabitEthernet 0/2)#mac access-group 700 in |
| Verification | <ul style="list-style-type: none"> ● On a visitor's PC, ping the financial data server. Verify that the ping operation fails. ● On a visitor's PC, ping the public resource server. Verify that the ping operation succeeds. ● On a visitor's PC, access the Internet, for example, visit the Baidu website. Verify that the webpage can be opened. |
| SW1 | <pre>sw1(config)#show access-lists mac access-list extended 700 10 deny any host 00e0.f800.000d etype-any 20 permit any any etype-any sw1(config)#show access-group mac access-group 700 in Applied On interface GigabitEthernet 0/2</pre> |

12.4.3 Configuring an Expert Extended ACL

Configuration Effect

Configure and apply an expert extended ACL to an interface/VXLAN to control incoming and outgoing packets of the interface/VXLAN based on the L2 and L3 information, and allow or prohibit the entry of specific packets to the network. In addition, you can configure an expert extended ACL to control all L2 packets based on the VLAN to permit or deny the access of users in some network segments to network resources. Generally, you can use an expert extended ACL if you want to incorporate ACEs of the IP ACL and MAC extended ACL into one ACL.

Configuration Steps

▾ Configuring an Expert Extended ACL

- (Mandatory) Configure an expert extended ACL if you want to control users' access to network resources based on the L2 packet header, for example, the VLAN ID.
- You can configure this ACL on an access, an aggregate, or a core device based on the distribution of users. The expert extended ACL takes effect only on the local device, and does not affect other devices on the network.

▾ Adding ACEs to an Expert Extended ACL

- (Optional) An ACL may contain zero or multiple ACEs. If no ACE is configured, all incoming packets of the device are denied by default.

▾ Applying an Expert Extended ACL

- (Mandatory) Apply an expert extended ACL to a specified interface if you want this ACL take effect.

- You can apply an expert extended ACL in the incoming or outgoing direction of a specified interface of an access, an aggregate, or a core device based on the distribution of users.

Verification

- Use the following methods to verify the configuration effects of the expert extended ACL:
- If IP-based access rules are configured in an expert extended ACL to permit or deny some IP packets, run the **ping** command to verify whether these rules take effect.
- If MAC-based access rules are configured in an expert extended ACL to permit or deny some L2 packets (e.g. ARP packets), also run the **ping** command to check whether ACEs of this ACL takes effect on the specified interface. For example, to filter out ARP packets, run the **ping** command for verification.
- If VLAN ID-based access rules are configured in an expert extended ACL to permit or deny some L2 packets in some network segments (e.g., to prevent communication between VLAN 1 users and VLAN 2 users), ping PCs of VLAN 2 on a PC of VLAN 1. If the ping operation fails, the rules take effect.

Related Commands

Configuring an Expert Extended ACL

| | |
|------------------------------|--|
| Command | expert access-list extended { <i>acl-name</i> <i>acl-id</i> } |
| Parameter Description | <i>acl-name</i> : Indicates the name of an expert extended ACL. If this option is configured, a named ACL is created. The name is a string of 1 to 99 characters. The ACL name cannot start with numbers (0–9), "in", or "out". <i>acl-id</i> : Indicates the ID of an expert extended ACL. If this option is configured, a numbered ACL is created. The value range of <i>acl-id</i> is 2700-2899. |
| Command Mode | Configuration mode |
| Usage Guide | Run this command to configure an expert extended ACL and enter expert extended ACL configuration mode. |

Adding ACEs to an Expert Extended ACL

Use either of the following methods to add ACEs to an expert extended ACL:

- Add ACEs in expert extended ACL configuration mode.

| | |
|------------------------------|---|
| Command | [<i>sn</i>] { permit deny } [<i>protocol</i> [<i>ethernet-type</i>] [cos [<i>out</i>] [<i>inner in</i>]]] [[VID [<i>out</i>] [<i>inner in</i>]]] { <i>source source-wildcard</i> host source any } { host source-mac-address any } { <i>destination destination-wildcard</i> host destination any } { host destination-mac-address any } [precedence precedence] [tos tos] [fragment] [range lower upper] [time-range time-range-name] |
| Parameter Description | <i>sn</i> : Indicates the sequence number of an ACE. The value ranges from 1 to 2,147,483,647. This sequence number determines the priority of this ACE in the ACL. A smaller sequence number indicates a higher priority. An ACE with a higher priority will be preferentially used to match packets. If you do not specify the sequence number when adding an ACE, the system automatically allocates a sequence number, which is equal to an increment (10 by default) plus the sequence number of the last ACE in the current ACL. For |

| | |
|---------------------|--|
| | <p>example, if the sequence number of the last ACE is 100, the sequence number of a newly-added ACE will be 110 by default. You can adjust the increment using a command.</p> <p>permit: Indicates that the ACE is a permit ACE.</p> <p>deny: Indicates that the ACE is a deny ACE.</p> <p><i>protocol:</i> Indicates the IP protocol number. The value ranges from 0 to 255. To facilitate the use, the system provides frequently-used abbreviations to replace the specific IP protocol numbers, including eigrp, gre, icmp, igmp, ip, ipinip, nos, ospf, tcp, and udp.</p> <p><i>ethernet-type:</i> Indicates that L2 packets of the specified Ethernet type are filtered.</p> <p>cos out: Indicates that L2 packets with the specified cos field in the outer tag are filtered.</p> <p>cos inner in: Indicates that L2 packets with the specified cos field in the inner tag are filtered.</p> <p>VID out: Indicates that L2 packets with the specified VLAN ID field in the outer tag are filtered.</p> <p>VID inner in: Indicates that L2 packets with the specified VLAN ID field in the inner tag are filtered.</p> <p><i>source source-wildcard:</i> Indicates that IP packets sent from hosts in the specified IP network segment are filtered.</p> <p>host source: Indicates that IP packets sent from a host with the specified source IP address are filtered.</p> <p>any: Indicates that IP packets sent from any host are filtered.</p> <p>host source-mac-address: Indicates that IP packets sent from a host with the specified source MAC address are filtered.</p> <p>any: Indicates that L2 packets sent to any host are filtered.</p> <p><i>destination destination-wildcard:</i> Indicates that IP packets sent to hosts in a specified IP network segment are filtered.</p> <p>host destination: Indicates that IP packets sent to a host with the specified destination IP address are filtered.</p> <p>any: Indicates that IP packets sent to any host are filtered.</p> <p>host destination-mac-address: Indicates that IP packets sent to a host with the specified destination MAC address are filtered.</p> <p>any: Indicates that L2 packets sent to any host are filtered.</p> <p>precedence precedence: Indicates that IP packets with the specified precedence field in the header are filtered.</p> <p>tos tos: Indicates that IP packets with the specified the TOS field in the header are filtered.</p> <p>dscp dscp: Indicates that IP packets with the specified the dscp field in the header are filtered.</p> <p>fragment: Indicates that only fragmented IP packets except the first fragments are filtered.</p> <p>time-range time-range-name: Indicates that this ACE is associated with a time range. The ACE takes effect only within this time range. For details about the time range, see the configuration manual of the time range.</p> |
| Command Mode | Expert extended ACL configuration mode |
| Usage Guide | Run this command to add ACEs in expert extended ACL configuration mode. The ACL can be a named or numbered ACL. |

- Add ACEs to an expert extended ACL in global configuration mode.

| | |
|----------------|---|
| Command | access-list <i>acl-id</i> { permit deny } [<i>protocol</i>] [<i>ethernet-type</i>] [cos [<i>out</i>] [inner <i>in</i>]] [[VID [<i>out</i>] [inner |
|----------------|---|

| | |
|------------------------------|--|
| | <pre>in]]] { source source-wildcard host source any } { host source-mac-address any } { destination destination-wildcard host destination any } { host destination-mac-address any } [precedence precedence] [tos tos] [fragment] [range lower upper] [time-range time-range-name]</pre> |
| Parameter Description | <p><i>acl-id</i>: Indicates the ID of a numbered ACL. It uniquely identifies an ACL. The value range of <i>acl-id</i> is 2700-2899.</p> <p>permit: Indicates that the ACE is a permit ACE.</p> <p>deny: Indicates that the ACE is a deny ACE.</p> <p><i>protocol</i>: Indicates the IP protocol number. The value ranges from 0 to 255. To facilitate the use, the system provides frequently-used abbreviations to replace the specific IP protocol numbers, including eigrp, gre, icmp, igmp, ip, ipinip, nos, ospf, tcp, and udp.</p> <p><i>ethernet-type</i>: Indicates that L2 packets of the specified Ethernet type are filtered.</p> <p>cos out: Indicates that L2 packets with the specified cos field in the outer tag are filtered.</p> <p>cos inner in: Indicates that L2 packets with the specified cos field in the inner tag are filtered.</p> <p>VID out: Indicates that L2 packets with the specified VLAN ID field in the outer tag are filtered.</p> <p>VID inner in: Indicates that L2 packets with the specified VLAN ID field in the inner tag are filtered.</p> <p><i>source source-wildcard</i>: Indicates that IP packets sent from hosts in the specified IP network segment are filtered.</p> <p>host source: Indicates that IP packets sent from a host with the specified source IP address are filtered.</p> <p>any: Indicates that IP packets sent from any host are filtered.</p> <p>host source-mac-address: Indicates that IP packets sent from a host with the specified source MAC address are filtered.</p> <p>any: Indicates that L2 packets sent to any host are filtered.</p> <p><i>destination destination-wildcard</i>: Indicates that IP packets sent to hosts in a specified IP network segment are filtered.</p> <p>host destination: Indicates that IP packets sent to a host with the specified destination IP address are filtered.</p> <p>any: Indicates that IP packets sent to any host are filtered.</p> <p>host destination-mac-address: Indicates that IP packets sent to a host with the specified destination MAC address are filtered.</p> <p>any: Indicates that L2 packets sent to any host are filtered.</p> <p>precedence precedence: Indicates that IP packets with the specified precedence field in the header are filtered.</p> <p>tos tos: Indicates that IP packets with the specified the TOS field in the header are filtered.</p> <p>dscp dscp: Indicates that IP packets with the specified the dscp field in the header are filtered.</p> <p>fragment: Indicates that only fragmented IP packets except the first fragments are filtered.</p> <p>time-range time-range-name: Indicates that this ACE is associated with a time range. The ACE takes effect only within this time range. For details about the time range, see the configuration manual of the time range.</p> |
| Command Mode | Expert extended ACL configuration mode |
| Usage Guide | Run this command to add ACEs to a numbered expert extended ACL in global configuration mode. It cannot be used to add ACEs to a named expert extended ACL. |

➤ **Applying an Expert Extended ACL**

| | |
|---------------------|--|
| Command | expert access-group { <i>acl-id</i> <i>acl-name</i> } { in out } |
| Parameter | <ul style="list-style-type: none"> ● <i>acl-id</i>: Indicates that a numbered expert extended ACL will be applied to the interface. |
| Description | <ul style="list-style-type: none"> ● <i>acl-name</i>: Indicates that a named expert extended ACL will be applied to the interface. ● in: Indicates that this ACL controls incoming L2 packets of the interface. ● out: Indicates that this ACL controls outgoing L2 packets of the interface. |
| Command Mode | Interface configuration mode |
| Usage Guide | This command makes an expert extended ACL take effect on the incoming or outgoing packets of a specified interface. |

Configuration Example

i The following configuration example describes only ACL-related configurations.

➤ **Configuring an Expert Extended ACL to Restrict Resources Accessible by Visitors (It is required that visitors and employees cannot communicate with each other, visitors can access the public resource server but not the financial data server of the company.)**

| | |
|--|--|
| <p>Scenario Figure 12-5</p> | <p>The diagram illustrates a central switch SW1 with four interfaces: Gi 0/1, Gi 0/2, Gi 0/3, and Gi 0/4. Gi 0/3 connects to a group of Servers, which includes a Financial Data Server (10.1.1.1/24) and a Public Server (10.1.1.2/24). Gi 0/4 connects to the Internet. Gi 0/1 and Gi 0/2 connect to two separate VLANs: VLAN 2 (Employees) and VLAN 3 (Visitors). Each VLAN contains PC1 and PC2. The IP segment for VLAN 2 is 192.168.1.0/24 with a gateway of 192.168.1.1/24. The IP segment for VLAN 3 is 192.168.2.0/24 with a gateway of 192.168.2.1/24.</p> |
| <p>Configuration Steps</p> | <ul style="list-style-type: none"> ● Configure an expert extended ACL. ● Add an ACE to deny packets sent from PCs in the visitor area (VLAN 3) to employee PCs in VLAN 2. ● Add an ACE to prevent visitors from accessing the financial data server of the company. ● Add an ACE to permit all packets. ● Apply the ACL to the incoming direction of the interface of the switch that connects to the visitor area. |
| <p>SW1</p> | <pre>sw1(config)#expert access-list extended 2700</pre> |

| | |
|---------------------|---|
| | <pre>sw1(config-exp-nacl)#deny ip any any 192.168.1.0 0.0.0.255 any sw1(config-exp-nacl)#deny ip any any host 10.1.1.1 any sw1(config-exp-nacl)#permit any any any any sw1(config-exp-nacl)#exit sw1(config)#int gigabitEthernet 0/2 sw1(config-if-GigabitEthernet 0/2)#expert access-group 2700 in</pre> |
| Verification | <ul style="list-style-type: none"> ● On a visitor's PC, ping the financial data server. Verify that the ping operation fails. ● On a visitor's PC, ping the public resource server. Verify that the ping operation succeeds. ● On a visitor's PC, ping the gateway address 192.168.1.1 of an employee. Verify that the ping operation fails. ● On a visitor's PC, access the Internet, for example, visit the Baidu website. Verify that the webpage can be opened. |
| SW1 | <pre>sw1(config)#show access-lists expert access-list extended 2700 10 deny ip any any 192.168.1.0 0.0.0.255 any 20 deny ip any any host 10.1.1.1 any 30 permit ip any any any any sw1(config)#show access-group expert access-group 2700 in Applied On interface GigabitEthernet 0/2</pre> |

12.4.4 Configuring an IPv6 Extended ACL

Configuration Effect

Configure and apply an IPv6 ACL to an interface/VXLAN to control all incoming and outgoing IPv5 packets of this interface/VXLAN. You can permit or deny the entry of specific IPv6 packets to a network to control access of IPv6 users to network resources.

Configuration Steps

▾ Configuring an IPv6 ACL

- (Mandatory) Configure an IP ACL if you want to access of IPv4 users to network resources.
- You can configure this ACL on an access, an aggregate, or a core device based on the distribution of users. The IPv6 ACL takes effect only on the local device, and does not affect other devices on the network.

➤ Adding ACEs to an IPv6 ACL

- (Optional) An ACL may contain zero or multiple ACEs. If no ACE is configured, all incoming IPv6 packets of the device are denied by default.

➤ Applying an IPv6 ACL

- (Mandatory) Apply an IPv6 ACL to a specified interface on a device if you want this ACL take effect.
- You can apply an IPv6 ACL on a specified interface/VXLAN of an access, an aggregate, or a core device based on the distribution of users.

Verification

- Use the following methods to verify the configuration effects of the IPv6 ACL:
- Run the **ping** command to verify that the IPv6 ACL takes effect on the specified interface. For example, if an IPv6 ACL is configured to prohibit a host with a specified IP address or hosts in a specified IPv6 address range from accessing the network, run the **ping** command to verify that the host(s) cannot be successfully pinged.
- Access network resources, for example, visit an IPv6 website, to check whether the IPv6 ACL takes effect on the specified interface.

Related Commands

➤ Configuring an IPv6 ACL

| | |
|------------------------------|---|
| Command | ipv6 access-list <i>acl-name</i> |
| Parameter Description | <i>acl-name</i> : Indicates the name of a standard or an extended IP ACL. The name is a string of 1 to 99 characters. The ACL name cannot start with numbers (0–9), "in", or "out". |
| Command Mode | Global configuration mode |
| Usage Guide | Run this command to configure an IPv6 ACL and enter IPv6 configuration mode. |

➤ Adding ACEs to an IPv6 ACL

- To filter TCP or UDP packets, add ACEs to an IPv6 ACL as follows:

| | |
|------------------------------|--|
| Command | <i>[sn]</i> { permit deny } <i>protocol</i> { <i>src-ipv6-prefix/prefix-len</i> host <i>src-ipv6-addr</i> any } { <i>dst-ipv6-pfx/pfx-len</i> host <i>dst-ipv6-addr</i> any } [<i>op dstport</i> range <i>lower upper</i>] [dscp <i>dscp</i>] [flow-label <i>flow-label</i>] [fragment] [time-range <i>tm-rng-name</i>] |
| Parameter Description | <i>sn</i> : Indicates the sequence number of an ACE. The value ranges from 1 to 2,147,483,647. This sequence number determines the priority of this ACE in the ACL. A smaller sequence number indicates a higher priority. An ACE with a higher priority will be preferentially used to match packets. If you do not specify the sequence number when adding an ACE, the system automatically allocates a sequence number, which is equal to an increment (10 by default) plus the sequence number of the last ACE in the current ACL. For example, if the sequence number of the last ACE is 100, the sequence number of a newly-added ACE will be 110 by default. You can adjust the increment using a command. permit : Indicates that the ACE is a permit ACE. |

| | |
|---------------------|---|
| | <p>deny: Indicates that the ACE is a deny ACE.</p> <p><i>protocol:</i> Indicates the IPv6 protocol number. The value ranges from 0 to 255. To facilitate the use, the system provides frequently-used abbreviations of IPv6 protocol numbers to replace the specific IP protocol numbers, including icmp, ipv6, tcp, and udp.</p> <p><i>src-ipv6-prefix/prefix-len:</i> Indicates that IP packets sent from hosts in the specified IPv6 network segment are filtered.</p> <p>host <i>src-ipv6-addr:</i> Indicates that IPv6 packets sent from a host with the specified source IP address are filtered.</p> <p>any: Indicates that IPv6 packets sent from any host are filtered.</p> <p><i>dst-ipv6-pfix/pfix-len:</i> Indicates that IPv6 packets sent from hosts in the specified IPv6 network segment are filtered.</p> <p>host <i>dst-ipv6-addr:</i> Indicates that IPv6 packets sent to a host with the specified destination IP address are filtered.</p> <p>any: Indicates that IPv6 packets sent to any host are filtered.</p> <p><i>op dstport:</i> Indicates that TCP or UDP packets are filtered based on the L4 destination port number. The value of the op parameter can be eq (equal to), neq (not equal to), gt (greater than), or lt (smaller than).</p> <p>range <i>lower upper:</i> Indicates that TCP or UDP packets with the L4 destination port number in the specified range are filtered.</p> <p>dscp <i>dscp:</i> Indicates that IPv6 packets with the specified the dscp field in the header are filtered.</p> <p>flow-label <i>flow-label:</i> Indicates that IPv6 packets with the specified the flow label field in the header are filtered.</p> <p>fragment: Indicates that only fragmented IPv6 packets except the first fragments are filtered.</p> <p>time-range <i>time-range-name:</i> Indicates that this ACE is associated with a time range. The ACE takes effect only within this time range. For details about the time range, see the configuration manual of the time range.</p> |
| Command Mode | IPv6 ACL configuration mode |
| Usage Guide | Run this command to add ACEs in IPv6 ACL configuration mode. |

- To filter IPv6 packets except for the TCP or UDP packets, add ACEs to an IPv6 ACL as follows:

| | |
|------------------------------|--|
| Command | [<i>sn</i>] { permit deny } <i>protocol</i> { <i>src-ipv6-prefix/prefix-len</i> host <i>src-ipv6-addr</i> any } { <i>dst-ipv6-pfix/pfix-len</i> host <i>dst-ipv6-addr</i> any } [dscp <i>dscp</i>] [flow-label <i>flow-label</i>] [fragment] [time-range <i>m-rng-name</i>] |
| Parameter Description | <p><i>sn:</i> Indicates the sequence number of an ACE. The value ranges from 1 to 2,147,483,647. This sequence number determines the priority of this ACE in the ACL. A smaller sequence number indicates a higher priority. An ACE with a higher priority will be preferentially used to match packets. If you do not specify the sequence number when adding an ACE, the system automatically allocates a sequence number, which is equal to an increment (10 by default) plus the sequence number of the last ACE in the current ACL. For example, if the sequence number of the last ACE is 100, the sequence number of a newly-added ACE will be 110 by default. You can adjust the increment using a command.</p> <p>permit: Indicates that the ACE is a permit ACE.</p> <p>deny: Indicates that the ACE is a deny ACE.</p> <p><i>protocol:</i> Indicates the IPv6 protocol number. The value ranges from 0 to 255. To facilitate the use, the</p> |

| | |
|---------------------|--|
| | <p>system provides frequently-used abbreviations of IPv6 protocol numbers to replace the specific IP protocol numbers, including icmp, ipv6, tcp, and udp.</p> <p><i>src-ipv6-prefix/prefix-len</i>: Indicates that IP packets sent from hosts in the specified IPv6 network segment are filtered.</p> <p>host <i>src-ipv6-addr</i>: Indicates that IPv6 packets sent from a host with the specified source IP address are filtered.</p> <p>any: Indicates that IPv6 packets sent from any host are filtered.</p> <p><i>dst-ipv6-pfix/pfix-len</i>: Indicates that IPv6 packets sent from hosts in the specified IPv6 network segment are filtered.</p> <p>host <i>dst-ipv6-addr</i>: Indicates that IPv6 packets sent to a host with the specified destination IP address are filtered.</p> <p>any: Indicates that IPv6 packets sent to any host are filtered.</p> <p>dscp <i>dscp</i>: Indicates that IPv6 packets with the specified the dscp field in the header are filtered.</p> <p>flow-label <i>flow-label</i>: Indicates that IPv6 packets with the specified the flow label field in the header are filtered.</p> <p>fragment: Indicates that only fragmented IPv6 packets except the first fragments are filtered.</p> <p>time-range <i>time-range-name</i>: Indicates that this ACE is associated with a time range. The ACE takes effect only within this time range. For details about the time range, see the configuration manual of the time range.</p> |
| Command Mode | IPv6 ACL configuration mode |
| Usage Guide | Run this command to add ACEs in IPv6 ACL configuration mode. |

📌 Applying an IPv6 ACL

| | |
|------------------------------|---|
| Command | ipv6 traffic-filter <i>acl-name</i> { in out } |
| Parameter Description | <p><i>acl-name</i>: Indicates the name of an IPv6 ACL.</p> <p>in: Indicates that this ACL controls incoming IPv6 packets of the interface.</p> <p>out: Indicates that this ACL controls outgoing IPv6 packets of the interface.</p> |
| Command Mode | Interface configuration mode |
| Usage Guide | This command makes an IPv6 ACL take effect on the incoming or outgoing packets of the specified interface. |

Configuration Example

📌 Configuring an IPv6 ACL to Prohibit the R&D Department from Accessing the Video Server

| | |
|---|---|
| <p>Scenario Figure 12-6</p> | |
| <p>Configuration Steps</p> | <ul style="list-style-type: none"> ● Configure an IPv6 ACL. ● Add an ACE to the IPv6 ACL to prevent access to the video server. ● Add an ACE to the IPv6 ACL to permit all IPv6 packets. ● Apply the IPv6 ACL to the incoming direction of the interface connected to the R&D department. |
| <p>SW1</p> | <pre>sw1(config)#ipv6 access-list dev_deny_ipv6video sw1(config-ipv6-nacl)#deny ipv6 any host 200::1 sw1(config-ipv6-nacl)#permit ipv6 any any sw1(config-ipv6-nacl)#exit sw1(config)#int gigabitEthernet 0/2 sw1(config-if-GigabitEthernet 0/2)# ipv6 traffic-filter dev_deny_ipv6video in</pre> |
| <p>Verification</p> | <ul style="list-style-type: none"> ● On a PC of the R&D department, ping the video server. Verify that the ping operation fails. |
| <p>SW1</p> | <pre>sw1(config)#show access-lists ipv6 access-list dev_deny_ipv6video 10 deny ipv6 any host 200::1 20 permit ipv6 any any sw1(config)#show access-group ipv6 traffic-filter dev_deny_ipv6video in Applied On interface GigabitEthernet 0/2</pre> |

12.4.5 Configuring a Security Channel

Configuration Effect

Configure a security channel to enable packets meeting the security channel rules to bypass the checks of access control applications. Configure the security channel if an access control application (such as DOT1X) is enabled on an uplink interface of a user, but the user should be allowed to log in to a website to download some resources (for example, downloading the Ruijie SU client) before the DOT1X authentication.

Configuration Steps

▾ Configuring an ACL

- (Mandatory) Configure an ACL before configuring the security channel. For details about the configuration method, see the earlier descriptions.
- You can configure this ACL on an access, an aggregate, or a core device based on the distribution of users. The configurations take effect only on the local device, and do not affect other devices on the network.

▾ Adding ACEs to an ACL

- (Optional) An ACL may contain zero or multiple ACEs. If no ACE is configured for an ACL, it is equivalent that the security channel does not take effect. For details about how to add an ACE to an ACL, see the related descriptions.

▾ Configuring a Security Channel on a Specified Interface, VXLAN or Globally

- Configure a security channel on an interface if you want this security channel to take effect on the interface. Configure a VXLAN security channel if you want this security channel to take effect on VNI. Configure a global security channel if you want this security channel to take effect globally. You must configure either the interface-based security channel or the global security channel.
- You can configure a security channel on an access, an aggregate, or a core device based on the distribution of users.

▾ Configuring an Exclusive Interface for the Global Security Channel

- (Optional) Configure an interface as the exclusive interface for the global security channel if you do not want the global security channel to take effect on this interface.

▾ Configuring an Access Control Application

- (Optional) You can enable the DOT1X or Web authentication function to verify the security channel function.
- You can configure the access control function on an access, an aggregate, or a core device based on the distribution of users.

Verification

On a PC that is subject to the control of an access control application, ping the resources (devices or servers) that are allowed to bypass the check of the access control application to verify the configuration of the security channel.

Related Commands

▾ Configuring an ACL

For details about how to configure an ACL, see the earlier descriptions about the IP ACL, MAC extended ACL, expert extended ACL, or IPv6 ACL.

▾ Adding ACEs to an ACL

For details about how to add ACEs to an ACL, see the earlier descriptions about the IP ACL, MAC extended ACL, expert extended ACL, or IPv6 ACL.

▾ Configuring a Security Channel on an Interface

| | |
|------------------------------|--|
| Command | security access-group { <i>acl-id</i> <i>acl-name</i> } |
| Parameter Description | <i>acl-id</i> : Indicates that ID of the ACL that is configured as the security channel. <i>acl-name</i> : Indicates that name of the ACL that is configured as the security channel. |
| Command Mode | Interface configuration mode |
| Usage Guide | Run this command to configure a specified ACL as the security channel on the specified interface. |

▾ Configuring a Global Security Channel

| | |
|------------------------------|--|
| Command | security global access-group { <i>acl-id</i> <i>acl-name</i> } |
| Parameter Description | <i>acl-id</i> : Indicates that ID of the ACL that is configured as the security channel. <i>acl-name</i> : Indicates that name of the ACL that is configured as the security channel. |
| Command Mode | Global configuration mode |
| Usage Guide | Run this command to configure the specified ACL as the global security channel. |

▾ Configuring an Exclusive Interface for the Global Security Channel

| | |
|------------------------------|--|
| Command | security uplink enable |
| Parameter Description | N/A |
| Command Mode | Interface configuration mode |
| Usage Guide | Run this command to configure the specified interface as the exclusive interface of the global security channel. |

Configuration Example

 The following configuration example describes only ACL-related configurations.

▾ Enabling DOT1X Authentication and Configuring a Security Channel to Allow Users to Download the SU Software From the Server Before Authentication

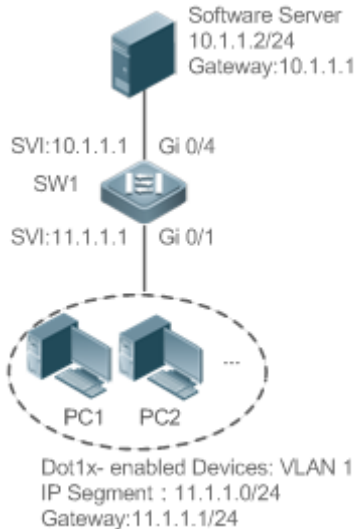
| | |
|---|--|
| <p>Scenario Figure 12-7</p> |  <p>Software Server 10.1.1.2/24 Gateway:10.1.1.1</p> <p>SVI:10.1.1.1 Gi 0/4 SW1</p> <p>SVI:11.1.1.1 Gi 0/1</p> <p>PC1 PC2 ...</p> <p>Dot1x-enabled Devices: VLAN 1 IP Segment : 11.1.1.0/24 Gateway:11.1.1.1/24</p> |
| <p>Configuration Steps</p> | <ul style="list-style-type: none"> ● Configure an expert extended ACL "exp_ext_esc". ● Add an ACE to allow forwarding packets to the destination host 10.1.1.2. ● Add an ACE to permit the DHCP packets. ● Add an ACE to permit the ARP packets. ● On the interface where DOT1X authentication is enabled, configure the ACL "exp_ext_esc" as the security channel. |
| <p>SW1</p> | <pre>sw1(config)#expert access-list extended exp_ext_esc sw1(config-exp-nacl)# permit ip any any host 10.1.1.2 any sw1(config-exp-nacl)# permit 0x0806 any any any any any sw1(config-exp-nacl)# permit tcp any any any any eq 67 sw1(config-exp-nacl)# permit tcp any any any any eq 68 sw1(config)#int gigabitEthernet 0/1 sw1(config-if-GigabitEthernet 0/1)# security access-group exp_ext_esc</pre> |
| <p>Verification</p> | <ul style="list-style-type: none"> ● On a PC of the sales department, ping the server of the sales department. Verify that the ping operation succeeds. ● On the PCs of R&D department 1 and R&D department 2, ping the server of the sales department. Verify that the ping operations fail. |
| | <pre>sw1#show access-lists expert access-list extended exp_ext_esc 10 permit ip any any host 10.1.1.2 any 20 permit arp any any any any 30 permit tcp any any any any eq 67</pre> |

```
40 permit tcp any any any any eq 68.....

sw1#show running-config interface gigabitEthernet 0/1

Building configuration...

Current configuration : 59 bytes

interface GigabitEthernet 0/1
 security access-group exp_ext_esc
```

12.4.6 Configuring the Time Range-Based ACEs

Configuration Effect

Configure the time range-based ACEs if you want some ACEs to take effect or to become invalid in a specified period of time, for example, in some time ranges during a week.

Configuration Steps

↘ **Configuring an ACL**

- (Mandatory) Configure an ACL if you want ACEs to take effect in the specified time range. For details about the configuration method, see the earlier descriptions.
- You can configure this ACL on an access, an aggregate, or a core device based on the distribution of users. The configurations take effect only on the local device, and do not affect other devices on the network.

↘ **Adding an ACE with the Time Range Specified**

- (Mandatory) Specify the time range when adding an ACE. For details about how to configure the time range, see the configuration manual related to the time range.

↘ **Applying an ACL**

- (Mandatory) Apply the ACL to a specified interface if you want to make ACEs take effect in the specified time range.
- You can apply an IP ACL on a specified interface of an access, an aggregate, or a core device based on the distribution of users.

Verification

In the time range that the configured ACE takes effect or becomes invalid, run the **ping** command or construct packets matching the ACE to check whether the ACE takes effect or becomes invalid.

Related Commands

➤ **Configuring an ACL**

For details about the ACL configuration commands, see the earlier descriptions about the IP ACL, MAC extended ACL, expert extended ACL, or IPv6 ACL.

➤ **Adding an ACE with the Time Range Specified**

For details about the ACE configuration commands, see the earlier descriptions about the IP ACL, MAC extended ACL, expert extended ACL, or IPv6 ACL.

➤ **Applying an ACL**

For details about the command for applying an ACL, see the earlier descriptions about the IP ACL, MAC extended ACL, expert extended ACL, or IPv6 ACL.

Configuration Example

i The following configuration example describes only ACL-related configurations.

➤ **Adding an ACE With the Time Range Specified to Allow the R&D Department to Access the Internet Between 12:00 and 13:30 Every Day**

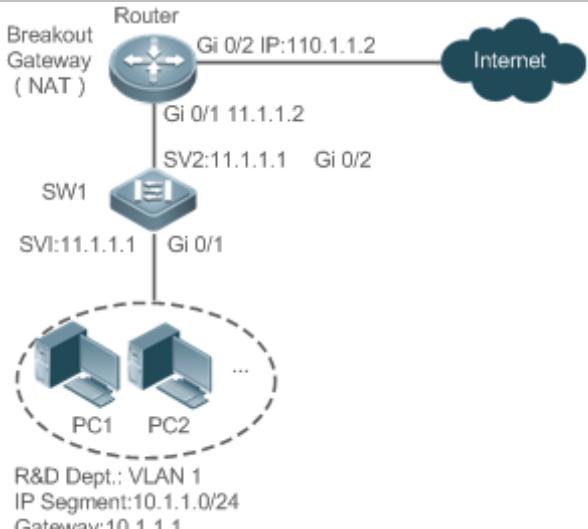
| | |
|--|--|
| <p>Scenario Figure 12-8</p> |  <p>R&D Dept.: VLAN 1 IP Segment: 10.1.1.0/24 Gateway: 10.1.1.1</p> |
| <p>Configuration Steps</p> | <ul style="list-style-type: none"> ● Configure a time range named "access-internet", and add an entry of the time range between 12:00 and 13:30 every day. ● Configure an IP ACL "ip_std_internet_acl". ● Add an ACE to allow packets with the source IP address in the network segment 10.1.1.0/24, and associate this ACE with the time zone "access-internet". ● Add an ACE to deny packets with the source IP address the network segment 10.1.1.0/24. Access to the Internet is not allowed except in the specified time range. ● Add an ACE to permit all packets. ● Apply the ACL to the outgoing direction of the interface connected to the breakout gateway. |

| | |
|---------------------|---|
| SW1 | <pre> Ruijie(config)# time-range access-internet Ruijie(config-time-range)# periodic daily 12:00 to 13:30 Ruijie(config-time-range)# exit sw1(config)# ip access-list standard ip_std_internet_acl sw1(config-std-nacl)# permit 10.1.1.0 0.0.0.255 time-range access-internet sw1(config-std-nacl)# deny 10.1.1.0 0.0.0.255 sw1(config-std-nacl)# permit any sw1(config-std-nacl)# exit sw1(config)#int gigabitEthernet 0/2 sw1(config-if-GigabitEthernet 0/2)# ip access-group ip_std_internet_acl out </pre> |
| Verification | <ul style="list-style-type: none"> ● Within the time range between 12:00 and 13:30, visit the Baidu website on a PC of the R&D department. Verify that the website can be opened normally. ● Beyond the time range between 12:00 and 13:30, visit the Baidu website on a PC of the R&D department. Verify that the website cannot be opened. |
| SW1 | <pre> sw1#show time-range time-range entry: access-internet (inactive) periodic Daily 12:00 to 13:30 sw1#show access-lists ip access-list standard ip_std_internet_acl 10 permit 10.1.1.0 0.0.0.255 time-range access-internet (inactive) 20 deny 10.1.1.0 0.0.0.255 30 permit any sw1#show access-group ip access-group ip_std_internet_acl out Applied On interface GigabitEthernet 0/2 </pre> |

12.4.7 Configuring Comments for ACLs

Configuration Effect

During network maintenance, if a lot of ACLs are configured without any comments, it is difficult to distinguish these ACLs later on. You can configure comments for ACLs to better understand the intended use of ACLs.

Configuration Steps

↘ Configuring an ACL

- (Mandatory) Configure an ACL before configuring the security channel. For details about the configuration method, see the earlier descriptions.
- You can configure this ACL on an access, an aggregate, or a core device based on the distribution of users. The configurations take effect only on the local device, and do not affect other devices on the network.

↘ Configuring Comments for ACLs

- (Optional) Configure comments for ACLs so that it is easy to manage and understand the configured ACLs.

↘ Adding ACEs to an ACL

- (Optional) An ACL may contain zero or multiple ACEs. If no ACE is configured, it is equivalent that the security channel does not take effect. For details about how to add an ACE to an ACL, see the related descriptions.

↘ Configuring Comments for ACEs

- (Optional) To facilitate understanding of a configured ACL, you can configure comments for ACEs in addition to comments for the ACL.

Verification

Run the **show access-lists** command on the device to display the comments configured for ACLs.

Related Commands

↘ Configuring an ACL

For details about how to configure an ACL, see the earlier descriptions about the IP ACL, MAC extended ACL, expert extended ACL, or IPv6 ACL.

↘ Configuring a Comment for an ACL

Use either of the following two methods to configure a comment for an ACL:

| | |
|------------------------------|---|
| Command | list-remark <i>comment</i> |
| Parameter Description | comment : Indicates the comment. The value is a string of 1 to 100 characters. A comment longer than 100 characters will be truncated to 100 characters. |
| Command | ACL configuration mode |

| | |
|--------------------|--|
| Mode | |
| Usage Guide | Run this command to configure the comment for a specified ACL. |

| | |
|------------------------------|--|
| Command | access-list <i>acl-id</i> list-remark <i>comment</i> |
| Parameter Description | <i>acl-id</i> : Indicates the ID of an ACL. <i>comment</i> : Indicates the comment. The value is a string of 1 to 100 characters. A comment longer than 100 characters will be truncated to 100 characters. |
| Command Mode | Configuration mode |
| Usage Guide | Run this command to configure the comment for a specified ACL. |

↘ Adding ACEs to an ACL

For details about how to add ACEs to an ACL, see the earlier descriptions about the IP ACL, MAC extended ACL, expert extended ACL, or IPv6 ACL.

↘ Configuring Comments for ACEs

Use either of the following two methods to configure a comment for an ACE:

| | |
|------------------------------|--|
| Command | remark <i>comment</i> |
| Parameter Description | <i>comment</i> : Indicates the comment. The value is a string of 1 to 100 characters. A comment longer than 100 characters will be truncated to 100 characters. |
| Command Mode | ACL configuration mode |
| Usage Guide | Run this command to configure the comment for a specified ACE. |

| | |
|------------------------------|--|
| Command | access-list <i>acl-id</i> remark <i>comment</i> |
| Parameter Description | <i>acl-id</i> : Indicates the ID of an ACL. <i>comment</i> : Indicates the comment. The value is a string of 1 to 100 characters. A comment longer than 100 characters will be truncated to 100 characters. |
| Command Mode | Global configuration mode |
| Usage Guide | Run this command to configure the comment for a specified ACE. |

12.5 Monitoring

Clearing

| Description | Command |
|--|---|
| Clears the ACL packet matching counters. | clear counters access-list [<i>acl-id</i> <i>acl-name</i>] |

Displaying

| Description | Command |
|--|---|
| Displays the basic ACLs. | show access-lists [<i>acl-id</i> <i>acl-name</i>] [summary] |
| Displays the redirection ACEs bound to a specified interface. If the interface is not specified, redirection ACEs bound to all interfaces are displayed. | show redirect [interface <i>interface-name</i>] |
| Displays the ACL configurations applied to an interface. | show access-group [interface <i>interface-name</i>] |
| Displays the IP ACL configurations applied to an interface. | show ip access-group [interface <i>interface-name</i>] |
| Displays the MAC extended ACL configurations applied to an interface. | show mac access-group [interface <i>interface-name</i>] |
| Displays the expert extended ACL configurations applied to an interface. | show expert access-group [interface <i>interface-name</i>] |
| Displays the IPv6 ACL configurations applied to an interface. | show ipv6 traffic-filter [interface <i>interface-name</i>] |

Debugging

 System resources are occupied when debugging information is output. Therefore, disable debugging immediately after use.

| Description | Command |
|---|----------------------------------|
| Debugs the ACL running process. | debug acl acl event |
| Debugs the ACL clients. | debug acl acl client-show |
| Debugs the ACLs created by all ACL clients. | debug acl acl acl-show |

13 Configuring SCC

13.1 Overview

The Security Control Center (SCC) provides common configuration methods and policy integration for various access control and network security services, so that these access control and network security services can coexist on one device to meet diversified access and security control requirements in various scenarios.

Typical access control services are dot1x, Web authentication, Address Resolution Protocol (ARP) check, and IP Source Guard. The network security services include Access Control List (ACL), Network Foundation Protection Policy (NFPP), and anti-ARP gateway spoofing. When two or more access control or network security services are simultaneously enabled on the device, or when both access control and network security services are simultaneously enabled on the device, the SCC coordinates the coexistence of these services according to relevant policies.

 For details about the access control and network security services, see the related configuration guide. This document describes the SCC only.

Protocol and Standards

N/A

13.2 Application

| Typical Application | Scenario |
|--|---|
| Access Control of Extended Layer 2 Campus Networks | Students on a campus network can access the Internet based on dot1x client authentication or Web authentication. ARP spoofing between the students should be prevented. In addition, terminal devices in some departments (such as the headmaster's office) can access the Internet without authentication. |

13.2.1 Access Control of Extended Layer 2 Campus Networks

Scenario

Students on a campus network of a university usually need to be authenticated through the dot1x client or Web before accessing the Internet, so as to facilitate accounting and guarantee the benefits of the university.

- The students can access the Internet through dot1x client authentication or Web authentication.
- ARP spoofing between the students is prevented, so as to guarantee the stability of the network.
- Terminal devices in some departments (such as the headmaster's office) can access the Internet without authentication.

Figure 13-1

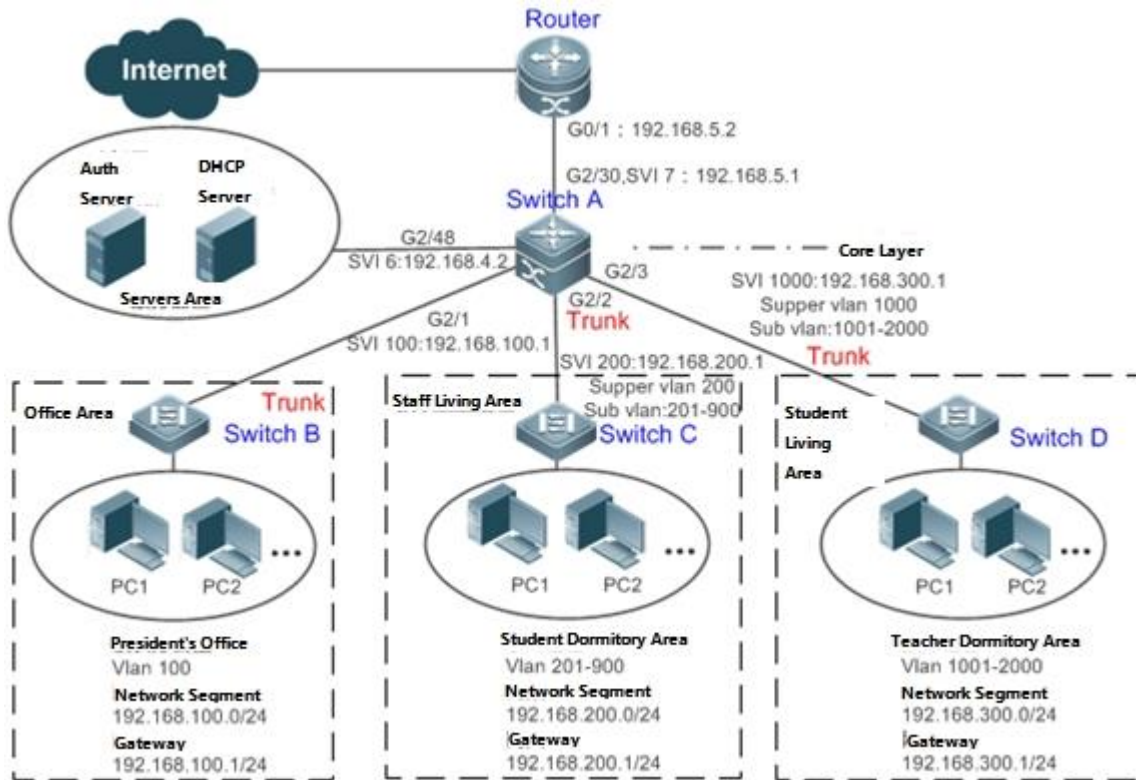

| | |
|-----------------------|--|
| <p>Remarks</p> | <p>A traditional campus network is hierarchically designed, which consists of an access layer, a convergence layer and a core layer, where the access layer performs user access control. On an extended Layer 2 campus network, however, user access control is performed by a core switch, below which access switches exist without involving any convergence device in between. The ports between the core switch and the access switches (such as switches B, C, and D in Figure 1-1) are all trunk ports.</p> <p>The user access switches B, C, and D connect to PCs in various departments via access ports, and VLANs correspond to sub VLANs configured on the downlink ports of the core switch, so that access users are in different VLANs to prevent ARP spoofing.</p> <p>The core switch A connects to various servers, such as the authentication server and the DHCP server. Super VLANs and sub VLANs are configured on the downlink ports. One super VLAN correspond to multiple sub VLANs, and each sub VLAN represents an access user.</p> |
|-----------------------|--|

Deployment

- On the core switch, different access users are identified by VLAN and port numbers. Each access user (or a group of access users) corresponds to one VLAN. The ports on each access switch that connect to downstream users are configured as access ports, and one user VLAN is assigned to each access user according to VLAN planning. The core switch does not forward ARP requests. The core switch replies to the ARP requests from authenticated users only, so as to prevent ARP spoofing. On the core switch A, user VLANs are regarded as sub VLANs, super VLANs are configured, and SVIs corresponding to the super VLANs are configured as user gateways.

- On the downlink ports of the core switch (switch A in this example) that connect to the teachers' living area and the students' living area, both dot1x authentication and Web authentication are enabled, so that users can freely select either authentication mode for Internet access.
- Any special department (such as the headmaster's office in this example) can be allocated to a particular VLAN, and this VLAN can be configured as an authentication-exemption VLAN so that users in this department can access the Internet without authentication.

13.3 Basic Concepts

User Online-Status Detection

For a chargeable user, accounting starts immediately after the user passes the authentication and gets online. The accounting process does not end until the user actively gets offline. Some users, however, forget to get offline when leaving their PCs, or cannot get offline because of terminal problems. Then the users suffer certain economical losses as the accounting process continues. To more precisely determine whether a user is really online, we can preset a traffic value, so that the user is considered as not accessing the Internet and therefore directly brought offline when the user's traffic is lower than the preset value in a period of time or there is not traffic of the user at all in a period of time.

Features

| Feature | Function |
|--|--|
| User Online-Status Detection | You can specify whether to detect the traffic of online users, so that a user is forced offline when the traffic of the user is lower than a preset value in a period of time. |

13.3.1 User Online-Status Detection

After a user accesses the Internet, the user may forget to get offline or cannot actively get offline due to terminal faults. In this case, the user will keep being charged and therefore will suffer a certain economical loss. To protect the benefits of users on the Internet, the device provides a function to detect whether the users are really online. If the device considers that a user is not online, the device actively disconnects the user.

Working Principle

A specific detection interval is preset on the device. If a user's traffic is lower than a certain value in this interval, the device considers that the user is not using the network and therefore directly disconnects the user.

 The user online-status detection function applies to only users who get online through dot1x or Web authentication.

13.3.2 User Policy Rules



After a user is successfully authenticated, the server may push some control policy names on this user. In this case, these control policy names need to be parsed by the SCC, which will convert these policy names to corresponding policy rules, and install the policies.

Working Principle

You can configure on a device the corresponding policy names, under which a speed-limit policy and filtering policy can be configured. After the user passes the authentication and the name of this policy is configured, corresponding speed-limit policy and filtering policy will take effect.

-
- ✔ The policy needs to be configured only for users that go online through dot1x authentication or Web authentication.
-

13.4 Configuration

| Configuration Item | Suggestions and Related Commands | |
|--|---|---|
| Configuring User Online-Status Detection |  Optional configuration, which is used to specify whether to enable the user online-status detection function. | |
| | offline-detect interval threshold | Configures the parameters of the user online-status detection function. |
| | no offline-detect | Disables the user online-status detection function. |
| | default offline-detect | Restores the default user online-status detection mode. |
| Configuring User Policy Rules |  (Optional) It is used to specify a user policy rule. | |
| | [no] rate-policy | Enters speed-limit policy configuration mode. |
| | upstream average-rate burst-rate | Configures the upstream traffic average and burst threshold. |
| | no upstream | Deletes the configuration for upstream traffic. |
| | downstream average-rate burst-rate | Configures the downstream traffic average and burst threshold. |
| | no downstream | Deletes the configuration for downstream traffic. |
| | [no] filter-policy | Enters filtering policy configuration mode. |
| | filter_acl | Configures the security ACL associated with the filtering policy. |
| | no filter_acl | Deletes the security ACL associated with the filtering policy. |
| | [no] service-policy | Enters user policy configuration mode. |
| | rate-policy apply | Configures the speed-limit policy to be used. |
| | no rate-policy | Deletes the speed-limit policy in use. |
| | filter-policy apply | Configures the filtering policy to be used. |
| no filter-policy | Deletes the filtering policy in use. | |

13.4.1 Configuring User Online-Status Detection

Configuration Effect

After the user online-status detection function is enabled, if a user's traffic is lower than a certain threshold within the specified period of time, the device automatically disconnects the user, so as to avoid the economical loss incurred by constant charging to the user.

Precautions

It should be noted that if disconnecting zero-traffic users is configured, generally software such as 360 Security Guard will run on a user terminal by default. Then such software will send packets time and again, and the device will disconnect the user only when the user's terminal is powered off.

Configuration Method

Configuring User Online-Status Detection

- Optional configuration. A user is disconnected if the user does not involve any traffic within eight hours by default.
- This configuration only works on the configured devices and does not affect other devices in the same network.

| | |
|------------------------------|---|
| Command | offline-detect interval <i>interval</i> threshold <i>threshold</i> no offline-detect default offline-detect |
| Parameter Description | <i>interval</i> : This parameter indicates the offline-detection interval. The value range is from 6 to 65535 in minutes on a switch or from 1 to 65535 in minutes on a non-switch device. The default value is 8 hours, that is, 480 minutes. <i>threshold</i> : This parameter indicates the traffic threshold. The value range is from 0 to 4294967294 in bytes. The default value is 0, indicating that the user is disconnected when no traffic of the user is detected. no offline-detect : Disables the user online-status detection function. default offline-detect : Restores the default value. In other words, an online user will be disconnected when the device detects that the user does not have any traffic within eight hours. |
| Defaults | 8 hours |
| Command Mode | Global configuration mode |
| Usage Guide | Use this command to configure user online-status detection, so that a user is disconnected when its traffic is lower than a specific threshold within a specific period of time. Use the no offline-detect command to disable the user online-status detection function, or use the default offline-detect command to restore the default detection mode. |

Verification

Check the user online-status detection configuration using the following method:

- After the user online-status detection function is enabled, power off the specified authenticated terminal after the corresponding user gets online. Then wait for the specified period of time, and run the online user query command associated with dot1x or Web authentication on the device to confirm that the user is already offline.

Configuration Examples

i The following configuration example describes SCC-related configuration only.

Configuring User Online-Status Detection so that a User Is Disconnected if the User Does Not Have Traffic Within Five Minutes

| | |
|--|--|
| <p>Scenario Figure 13-2</p> | |
| <p>Configuration Steps</p> | <ul style="list-style-type: none"> ● Enable dot1x authentication on the access port Gi 0/2, and configure authentication parameters. The authentication is MAC-based. ● Configure user online-status detection so that a user is disconnected if the user does not have traffic within five minutes. |
| <p>Switch A</p> | <pre>sw1(config)# offline-detect interval 5 threshold 0</pre> |
| <p>Verification</p> | <ul style="list-style-type: none"> ● Perform dot1x authentication using dot1x SU client for a PC in the R&D department, so that the PC gets online. Then power off the PC, wait for 6 minutes, and run the online user query command available with dot1x authentication on switch 1 to confirm that the user of the PC is already offline. |
| <p>Switch A</p> | <pre>sw1(config)#show running-config include offline-detect offline-detect interval 5</pre> |

13.4.2 Configuring User Policy Rules

Configuration Effect

After user policy rules are configured, you can perform speed-limit configuration for an authenticated user of specified policy names based on these policy rules.

Notes

An authentication server is required to push corresponding policy attributes. Existing policy rules support speed limit configuration and filtering configuration of wireless platforms.

Configuration Steps

Configuring User Policy Rules

- Optional.
- Configure the speed-limit policy and filtering policy first. Then configure the speed-limit policy name in the user policy rule.

 The burst thresholds of upstream and downstream parameters must not be smaller than the average.

| | |
|------------------------------|--|
| Command | rate-policy <i>name</i> {downstream upstream } average-rate <i>avg-threshold</i> burst-rate <i>burst-threshold</i> |
| Parameter Description | name: Indicates the name of a speed-limit policy. avg-threshold: Indicates the traffic average, in the unit of KBps. The value ranges from 8 to 261,120. burst-threshold: Indicates the traffic burst threshold, in the unit of KBps. The value ranges from 8 to 261,120. The burst threshold must not be smaller than the average. |
| Defaults | N/A |
| Command Mode | Global configuration mode |
| Usage Guide | Speed-limit strategy rules must be configured first. |
| Command | filter-policy <i>name</i> filter-acl { <i>acl-name</i> <i>acl-id</i> } |
| Parameter Description | name: Indicates the name of a filtering policy. acl-name: Indicates the name of the security ACL associated with the filtering policy. acl-id: Indicates the ID of the security ACL associated with the filtering policy. |
| Defaults | N/A |
| Command Mode | Global configuration mode |
| Usage Guide | Filtering strategy rules must be configured first. |
| Command | service-policy <i>service-name</i> rate-policy <i>rate-name</i> apply filter-policy <i>filter-name</i> apply |
| Parameter Description | service-name: Indicates the name of a user policy. rate-name: Indicates the name of the speed-limit policy to be used. |

| | |
|---------------------|---|
| | <i>filter-name</i> : Indicates the name of the filtering policy to be used. |
| Defaults | N/A |
| Command Mode | Global configuration mode |
| Usage Guide | A speed-limit policy and filtering policy can be used user policy rules only after they are configured. |

Verification

You can check the configuration effect of a policy rule as follows:

- After a speed-limit policy is configured and the user goes online through authentication, check the speed-limit policy entry corresponding to the WQoS.
- After a filtering policy is configured and the user goes online through authentication, check the ACL entry corresponding to the ACLK.

Configuration Example

Specifying the Speed-limit Policy of an Authenticated User Using a User Policy Rule

| | |
|----------------------------|--|
| Configuration Steps | <ul style="list-style-type: none"> ● Enable Web control on WLAN 1 and configure the corresponding user policy name on a server. ● Configure a user policy rule and specify a speed-limit policy. |
| Switch A | <pre>AC(config)# rate-policy user-rate AC(config-rate-policy)#upstream average-rate 10 burst-rate 10 AC(config-rate-policy)#downstream average-rate 10 burst-rate 10 AC(config)# ip access-list extended user_2000 AC(config)# filter-policy user-filter AC(config-filter-policy)#filter-acl user_2000AC(config)# service-policy user-policy AC(config-service-policy)# rate-policy user-rate apply AC(config-service-policy)# filter-policy user-filter apply</pre> |
| Verification | <ul style="list-style-type: none"> ● After the user passes authentication, display upstream and downstream packets speeds. |

13.5 Monitoring

Displaying

N/A

Debugging

-  System resources are occupied when debugging information is output. Therefore, close the debugging switch immediately after use.



| Command | Function |
|--|--|
| debug scc event | Debugs the SCC running process. |
| debug scc user [mac author mac] | Debugs SCC user entries. |
| debug scc acl-show summary | Debugs ACLs stored in the current SCC and delivered by various services. |
| debug scc acl-show all | Debugs all ALCs stored in the current SCC. |

14 Configuring SSH

14.1 Overview

Secure Shell (SSH) connection is similar to a Telnet connection except that all data transmitted over SSH is encrypted. When a user in an insecure network environment logs into a device remotely, SSH helps ensure information security and powerful authentication, protecting the device against attacks such as IP address spoofing and plain-text password interception.

An SSH-capable device can be connected to multiple SSH clients. In addition, the device can also function as an SSH client, and allows users to set up an SSH connection with a SSH-server device. In this way, the local device can safely log in to a remote device through SSH to implement management.

-  Currently, a device can work as either the SSH server or an SSH client, supporting SSHv1 and SSHv2 versions. Ruijie SSH service supports both IPv4 and IPv6.
-  Unless otherwise specified, SSH in this document refers to SSHv2.

Protocols and Standards

- RFC 4251: The Secure Shell (SSH) Protocol Architecture
- RFC 4252: The Secure Shell (SSH) Authentication Protocol
- RFC 4253: The Secure Shell (SSH) Transport Layer Protocol
- RFC 4254: The Secure Shell (SSH) Connection Protocol
- RFC 4419: Diffie-Hellman Group Exchange for the Secure Shell (SSH) Transport Layer Protocol
- RFC 4716: The Secure Shell (SSH) Public Key File Format
- RFC 4819: Secure Shell Public Key Subsystem
- RFC 3526: More Modular Exponential (MODP) Diffie-Hellman groups for Internet Key Exchange (IKE)
- RFC 2409: The Internet Key Exchange (IKE)
- RFC 1950: ZLIB Compressed Data Format Specification version 3.3
- draft-ietf-secsh-filexfer-05: SSH File Transfer Protocol
- draft-ylonen-ssh-protocol-00: The version of the SSH Remote Login Protocol is 1.5. Comware implements the SSH server functions, but not the SSH client functions.

14.2 Applications

| Application | Description |
|---|---|
| SSH Device Management | Use SSH to manage devices. |
| SSH Local Line Authentication | Use the local line password authentication for SSH user authentication. |

| Application | Description |
|---|--|
| SSH AAA Authentication | Use the authentication, authorization and accounting (AAA) mode for SSH user authentication. |
| SSH Public Key Authentication | Use the public key authentication for SSH user authentication. |
| SSH File Transfer | Use the Secure Copy (SCP) commands on the client to exchange data with the SSH server. |

14.2.1 SSH Device Management

Scenario

You can use SSH to manage devices on the precondition that the SSH server function is enabled. By default, this function is disabled. The Telnet component that comes with the Windows system does not support SSH. Therefore, a third-party client software must be used. Currently, well-compatible software includes PuTTY, Linux, and SecureCRT. The following takes the PuTTY as an example to introduce the configurations of the SSH client. Figure 14-1 shows the network topology.

Figure 14-1 Networking Topology of SSH Device Management



Deployment

Configure the SSH client as follows:

- Start the PuTTY software.
- On the **Session** option tab of PuTTY, type in the host IP address of the SSH server and SSH port number **22**, and select the connection type **SSH**.
- On the **SSH** option tab of PuTTY, select the preferred SSH protocol version **2**.
- On the **SSH authentication** option tab of PuTTY, select the authentication method **Attempt "keyboard-interactive" auth**.
- Click **Open** to connect to the SSH server.
- Type in the correct user name and password to enter the terminal login interface.

14.2.2 SSH Local Line Authentication

Scenario

SSH clients can use the local line password authentication mode, as shown in Figure 14-2. To ensure security of data exchange, PC 1 and PC 2 function as the SSH clients, and use the SSH protocol to log in to the network device where the SSH server function is enabled. The requirements are as follows:

- SSH users use the local line password authentication mode.

- Five lines, including Line 0 to Line 4, are activated concurrently. The login password is "passzero" for Line 0 and "pass" for the remaining lines. Any user name can be used.

Figure 14-2 Networking Topology of SSH Local Line Password Authentication

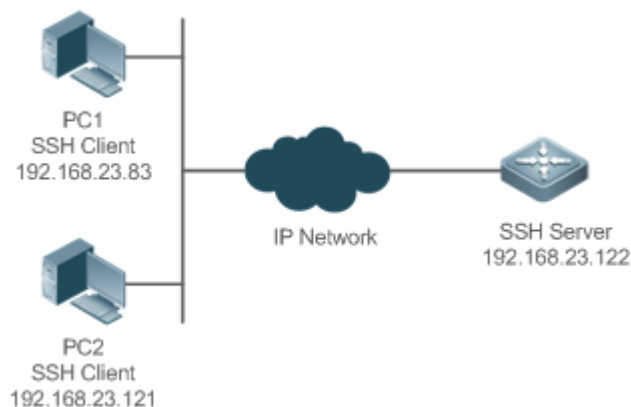

Deployment

- Configure the SSH server as follows:
 1. Enable the SSH server function globally. By default, the SSH server supports two SSH versions: SSHv1 and SSHv2.
 2. Configure the key. With this key, the SSH server decrypts the encrypted password received from the SSH clients, compares the decrypted plain text with the password stored on the server, and returns a message indicating the successful or unsuccessful authentication. SSHv1 uses an RSA key, whereas SSHv2 adopts an RSA or DSA key.
 3. Configure the IP address of the FastEthernet 0/1 interface on the SSH server. The SSH client is connected to the SSH server using this IP address. The routes from the SSH clients to the SSH server are reachable.
- Configure the SSH client as follows:

Diversified SSH client software is available, including PuTTY, Linux, and OpenSSH. This document takes PuTTY as an example to explain the method for configuring the SSH clients.

1. Open the PuTTY connection tab, and select SSHv1 for authenticated login. (The method is similar if SSHv2 is selected.)
2. Set the IP address and connected port ID of the SSH server. As shown in the network topology, the IP address of the server is 192.168.23.122, and the port ID is 22. Click Open to start the connection. As the current authentication mode does not require a user name, you can type in any user name, but cannot be null. (In this example, the user name is "anyname".)

14.2.3 SSH AAA Authentication

Scenario

SSH users can use the AAA authentication mode for user authentication, as shown in Figure 14-3. To ensure security of data exchange, the PCs function as the SSH clients, and uses the SSH protocol to log in to the network device where the SSH server is enabled. To better perform security management, the AAA authentication mode is used for user login on the SSH clients. Two authentication methods, including Radius server authentication and local authentication, are provided in the AAA

authentication method list to ensure reliability. The Radius server authentication method is preferred. If the Radius server does not respond, it turns to the local authentication.

Figure 14-3 Networking Topology of SSH AAA Authentication

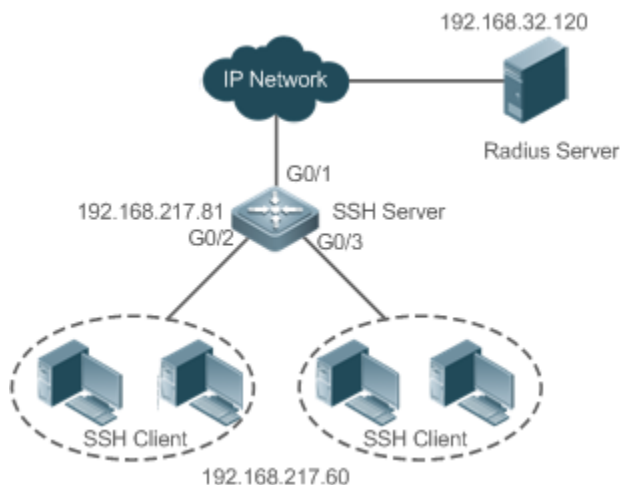

Deployment

- The routes from the SSH clients to the SSH server are reachable, and the route from the SSH server to the Radius server is also reachable.
- Configure the SSH server on the network device that functions as an SSH client.
- Configure the AAA parameters on the network device. When the AAA authentication mode is used, method lists are created to define the identity authentication and types, and applied to a specified service or interface.

14.2.4 SSH Public Key Authentication

Scenario

SSH clients can use the public keys for authentication, and the public key algorithm can be RSA or DSA, as shown in Figure 14-4. SSH is configured on the client so that a secure connection is set up between the SSH client and the SSH server.

Figure 14-4 Network Topology for Public Key Authentication of SSH Users



Deployment

- To implement public key authentication for the client, generate a key pair (RSA or DSA) on the client, configure the public key on the SSH server, and select the public key authentication mode.

- After the key is generated on the client, the SSH server will copy the file of the public key from the client to the flash and associates the file with the SSH user name. Each user can be associated with one RSA public key and one DSA public key.

14.2.5 SSH File Transfer

Scenario

The SCP service is enabled on the server, and SCP commands are used on the client to transfer data to the server, as shown in Figure 14-5.

Figure 14-5 Networking Topology of SSH File Transfer



Deployment

- Enable the SCP service on the server.
- On the client, use SCP commands to upload files to the server, or download files from the server.

14.3 Features

Basic Concepts

↘ User Authentication Mechanism

- Password authentication

During the password authentication, a client sends a user authentication request and encrypted user name and password to the server. The server decrypts the received information, compares the decrypted information with those stored on the server, and then returns a message indicating the successful or unsuccessful authentication.

- Public key authentication

During the public key authentication, digital signature algorithms, such as RSA and DSA, are used to authenticate a client. The client sends a public key authentication request to the server. This request contains information including the user name, public key, and public key algorithm. On receiving the request, the server checks whether the public key is correct. If wrong, the server directly sends an authentication failure message. If right, the server performs digital signature authentication on the client, and returns a message indicating the successful or unsuccessful authentication.

i Public key authentication is applicable only to the SSHv2 clients.

↘ SSH Communication

To ensure secure communication, interaction between an SSH server and an SSH client undergoes the following seven stages:

- Connection setup

The server listens on Port 22 to the connection request from the client. After originating a socket initial connection request, the client sets up a TCP socket connection with the server.

- Version negotiation

If the connection is set up successfully, the server sends a version negotiation packet to the client. On receiving the packet, the client analyzes the packet and returns a selected protocol version to the server. The server analyzes the received information to determine whether version negotiation is successful.

- Key exchange and algorithm negotiation

If version negotiation is successful, key exchange and the algorithm negotiation are performed. The server and the client exchange the algorithm negotiation packet with each other, and determine the final algorithm based on their capacity. In addition, the server and the client work together to generate a session key and a session ID according to the key exchange algorithm and host key, which will be applied to subsequent user authentication, data encryption, and data decryption.

- User authentication

After the encrypted channel is set up, the client sends an authentication request to the server. The server repeatedly conducts authentication for the client until the authentication succeeds or the server shuts down the connection because the maximum number of authentication attempts is reached.

- Session request

After the successful authentication, the client sends a session request to the server. The server waits and processes the client request. After the session request is successfully processed, SSH enters the session interaction stage.

- Session interaction

After the session request is successfully processed, SSH enters the session interaction stage. Encrypted data can be transmitted and processed in both directions. The client sends a command to be executed to the client. The server decrypts, analyzes, and processes the received command, and then sends the encrypted execution result to the client. The client decrypts the execution result.

- Session ending

When the interaction between the server and the client is terminated, the socket connection disconnects, and the session ends.

Overview

| Feature | Description |
|-----------------------------|--|
| SSH Server | Enable the SSH server function on a network device, and you can set up a secure connection with the network device through the SSH client. |
| SCP Service | After the SCP service is enabled, you can directly download files from the network device and upload local files to the network device. In addition, all interactive data is encrypted, featuring authentication and security. |

14.3.1 SSH Server

Enable the SSH server function on a network device, and you can set up a secure connection with the network device through the SSH client. You can also shut down the SSH server function to disconnect from all SSH clients.

Working Principle

For details about the working principle of the SSH server, see the "SSH Communication" in "Basic Concepts." In practice, after enabling the SSH server function, you can configure the following parameters according to the application requirements:

- Version: Configure the SSH version as SSHv1 or SSHv2 to connect SSH clients.
- Authentication timeout: The SSH server starts the timer after receiving a user connection request. The SSH server is disconnected from the client either when the authentication succeeds or when the authentication timeout is reached.
- Maximum number of authentication retries: The SSH server starts authenticating the client after receiving its connection request. If authentication does not succeed when the maximum number of user authentication retries is reached, a message is sent, indicating the authentication failure.
- Public key authentication: The public key algorithm can be RSA or DSA. It provides a secure connection between the client and the server. The public key file on the client is associated with the user name. In addition, the public key authentication mode is configured on the client, and the corresponding private key file is specified. In this way, when the client attempts to log in to the server, public key authentication can be implemented to set up a secure connection.

Related Configuration

▾ Enabling the SSH Server

By default, the SSH server is disabled.

In global configuration mode, run the **[no] enable service ssh-server** command to enable or disable the SSH server.

To generate the SSH key, you also need to enable the SSH server.

▾ Specifying the SSH Version

By default, the SSH server supports both SSHv1 and SSHv2, connecting either SSHv1 clients or SSHv2 clients.

Run the **ip ssh version** command to configure the SSH version supported by the SSH server.

If only SSHv1 or SSHv2 is configured, only the SSH client of the configured version can be connected to the SSH server.

▾ Configuring the SSH Authentication Timeout

By default, the user authentication timeout is 120s.

Run the **ip ssh time-out** command to configure the user authentication timeout of the SSH server. Use the **no** form of the command to restore the default timeout. The SSH server starts the timer after receiving a user connection request. If authentication does not succeed before the timeout is reached, authentication times out and fails.

▾ Configuring the Maximum Number of SSH Authentication Retries

By default, the maximum number of user authentication retries is 3.

Run the **ip ssh authentication-retries** command to configure the maximum number of user authentication retries on the SSH server. Use the **no** form of the command to restore the default number of user authentication retries. If authentication still does not succeed when the maximum number of user authentication retries is reached, user authentication fails.

↘ Enabling the Public Key Authentication on the SSH Server

Run the **ip ssh peer** command to associate the public key file on the client with the user name. When the client is authenticated upon login, a public key file is specified based on the user name.

14.3.2 SCP Service

The SSH server provides the SCP service to implement secure file transfer between the server and the client.

Working Principle

- SCP is a protocol that supports online file transfer. It runs on Port 22 based on the BSC RCP protocol, whereas RCP provides the encryption and authentication functions based on the SSH protocol. RCP implements file transfer, and SSH implements authentication and encryption.
- Assume that the SCP service is enabled on the server. When you use an SCP client to upload or download files, the SCP client first analyzes the command parameters, sets up a connection with a remote server, and starts another SCP process based on this connection. This process may run in source or sink mode. (The process running in source mode is the data provider. The process running in sink mode is the destination of data.) The process running in source mode reads and sends files to the peer end through the SSH connection. The process running in sink mode receives files through the SSH connection.

Related Configuration

↘ Enabling the SCP Server

By default, the SCP server function is disabled.

Run the **ip scp server enable** command to enable SCP server function on a network device.

14.4 Configuration

| Configuration | Description and Command | |
|--|---|--|
| Configuring the SSH Server |  It is mandatory to enable the SSH server. | |
| | enable service ssh-server | Enables the SSH server. |
| | disconnect ssh[<i>vtty</i>] <i>session-id</i> | Disconnects an established SSH session. |
| | crypto key generate {<i>rsa dsa</i>} | Generates an SSH key. |
| | ip ssh version {<i>1 2</i>} | Specifies the SSH version. |
| | ip ssh time-out <i>time</i> | Configures the SSH authentication timeout. |
| | ip ssh authentication-retries <i>retry times</i> | Configures the maximum number of SSH authentication retries. |

| Configuration | Description and Command | |
|---|--|--|
| | <code>ip ssh peer test public-key rsa flash :rsa.pub</code> | Associates an RSA public key file with a user. |
| | <code>ip ssh peer test public-key dsa flash :dsa.pub</code> | Associates a DSA public key file with a user. |
| Configuring the SCP Service |  Mandatory. | |
| | <code>ip scp server enable</code> | Enables the SCP server. |

14.4.1 Configuring the SSH Server

Configuration Effect

- Enable the SSH server function on a network device so that you can set up a secure connection with a remote network device through the SSH client. All interactive data is encrypted before transmitted, featuring authentication and security.
- You can use diversified SSH user authentications modes, including local line password authentication, AAA authentication, and public key authentication.
- You can generate or delete an SSH key.
- You can specify the SSH version.
- You can configure the SSH authentication timeout.
- You can configure the maximum number of SSH authentication retries.

Notes

- The precondition of configuring a device as the SSH server is that communication is smooth on the network that the device resides, and the administrator can access the device management interface to configure related parameters.
- The **no crypto key generate** command does not exist. You need to run the **crypto key zeroize** command to delete a key.
- The SSH module does not support hot standby. Therefore, for products that supports hot standby on the supervisor modules, if no SSH key file exist on the new active module after failover, you must run the **crypto key generate** command to re-generate a key before using SSH.

Configuration Steps

▾ Enabling the SSH Server

- Mandatory.
- By default, the SSH server is disabled. In global configuration mode, enable the SSH server and generate an SSH key so that the SSH server state changes to ENABLE.

▾ Specifying the SSH Version

- Optional.

- By default, the SSH server supports SSHv1 and SSHv2, connecting either SSHv1 or SSHv2clients. If only SSHv1 or SSHv2 is configured, only the SSH client of the configured version can be connected to the SSH server.

▾ Configuring the SSH Authentication Timeout

- Optional.
- By default, the SSH authentication timeout is 120s. You can configure the user authentication timeout as required. The value ranges from 1 to 120. The unit is second.

▾ Configuring the Maximum Number of SSH Authentication Retries

- Optional.
- Configure the maximum number of SSH authentication retries to prevent illegal behaviors such as malicious guessing. By default, the maximum number of SSH authentication retries is 3, that is, a user is allowed to enter the user name and password three times for authentication. You can configure the maximum number of retries as required. The value ranges from 0 to 5.

▾ Enabling the Public Key Authentication for SSH Users

- Optional.
- Only SSHv2 supports authentication based on the public key. This configuration associates a public key file on the client with a user name. When a client is authenticated upon login, a public key file is specified based on the user name.

Verification

- Run the **show ip ssh** command to display the current SSH version, authentication timeout, and maximum number of authentication retries of the SSH server.
- Run the **show crypto key mypubkey** command to display the public information of the public key to verify whether the key has been generated.
- Configure the public key authentication login mode on the SSH client and specify the private key file. Check whether you can successfully log in to the SSH server from the SSH client. If yes, the public key file on the client is successfully associated with the user name, and public key authentication succeeds.

Related Commands

▾ Enabling the SSH Server

| | |
|---------------------|---|
| Command | enable service ssh-server |
| Parameter | N/A |
| Description | |
| Command Mode | Global configuration mode |
| Usage Guide | To disable the SSH server, run the no enable service ssh-server command in global configuration mode. After this command is executed, the SSH server state changes to DISABLE. |

↘ Disconnecting an Established SSH Session

| | |
|---------------------|--|
| Command | disconnect ssh[vty] session-id |
| Parameter | vty: Indicates an established virtual teletype terminal (VTY) session. |
| Description | <i>session-id:</i> Indicates the ID of the established SSH session. The value ranges from 0 to 35. |
| Command Mode | Privileged EXEC mode |
| Usage Guide | Specify an SSH session ID to disconnect the established SSH session. Alternatively, specify a VTY session ID to disconnect a specified SSH session. Only an SSH session can be disconnected. |

↘ Generating an SSH Key

| | |
|---------------------|---|
| Command | crypto key generate {rsa dsa} |
| Parameter | rsa: Generates an RSA key. |
| Description | dsa: Generates a DSA key. |
| Command Mode | Global configuration mode |
| Usage Guide | The no crypto key generate command does not exist. You need to run the crypto key zeroize command to delete a key. SSHv1 uses an RSA key, whereas SSHv2 uses an RSA or DSA key. If an RSA key is generated, both SSHv1 and SSHv2 are supported. If only a DSA key is generated, only SSHv2 can use the key. |

↘ Specifying the SSH Version

| | |
|---------------------|---|
| Command | ip ssh version {1 2} |
| Parameter | 1: Indicates that the SSH server only receives the connection requests sent by SSHv1 clients. |
| Description | 2: Indicates that the SSH server only receives the connection requests sent by SSHv2 clients. |
| Command Mode | Global configuration mode |
| Usage Guide | Run the no ip ssh version command to restore the default settings. By default, the SSH server supports both SSHv1 and SSHv2. |

↘ Configuring the SSH Authentication Timeout

| | |
|---------------------|---|
| Command | ip ssh time-out time |
| Parameter | <i>time:</i> Indicates the SSH authentication timeout. The value ranges from 1 to 120. The unit is second. |
| Description | |
| Command Mode | Global configuration mode |
| Usage Guide | Run the no ip ssh time-out command to restore the default SSH authentication timeout, which is 120s. |

↘ Configuring the Maximum Number of SSH Authentication Retries

| | |
|----------------|--|
| Command | ip ssh authentication-retries retry times |
|----------------|--|

| | |
|------------------------------|---|
| Parameter Description | <i>retry times</i> : Indicates the maximum number of user authentication retries. The value ranges from 0 to 5. |
| Command Mode | Global configuration mode |
| Usage Guide | Run the no ip ssh authentication-retries command to restore the default number of user authentication retries, which is 3. |

↘ Configuring RSA Public Key Authentication

| | |
|------------------------------|---|
| Command | ip ssh peer test public-key rsaflash:rsa.pub |
| Parameter Description | <i>test</i> : Indicates the user name. rsa : Indicates that the public key type is RSA. <i>rsa.pub</i> : Indicates the name of a public key file. |
| Command Mode | Global configuration mode |
| Usage Guide | This command is used to configure the RSA public key file associated with user <i>test</i> . Only SSHv2 supports authentication based on the public key. This command associates the public key file on the client with the user name. When the client is authenticated upon login, a public key file is specified based on the user name. |

↘ Configuring DSA Public Key Authentication

| | |
|------------------------------|--|
| Command | ip ssh peer test public-key dsaflash:dsa.pub |
| Parameter Description | <i>test</i> : Indicates the user name. dsa : Indicates that the public key type is DSA. <i>dsa.pub</i> : Indicates the name of a public key file. |
| Command Mode | Global configuration mode |
| Usage Guide | This command is used to configure the DSA key file associated with user test . Only SSHv2 supports authentication based on the public key. This command associates the public key file on the client with the user name. When the client is authenticated upon login, a public key file is specified based on the user name. |

Configuration Example

 The following configuration examples describe only configurations related to SSH.

↘ Generating a Public Key on the SSH Server

| | |
|----------------------------|---|
| Configuration Steps | <ul style="list-style-type: none"> Run the crypto key generate { rsa dsa } command to generate a RSA public key for the server. |
|----------------------------|---|

| | |
|----------------------------|--|
| <p>SSH Server</p> | <pre>Ruijie#configure terminal Ruijie(config)# crypto key generate rsa Choose the size of the rsa key modulus in the range of 512 to 2048 and the size of the dsa key modulus in the range of 360 to 2048 for your Signature Keys. Choosing a key modulus greater than 512 may take a few minutes. How many bits in the modulus [512]:</pre> <ul style="list-style-type: none"> ● If the generation of the RSA key is successful, the following information is displayed: <pre>% Generating 512 bit RSA1 keys ...[ok] % Generating 512 bit RSA keys ...[ok]</pre> <ul style="list-style-type: none"> ● If the generation of the RSA key fails, the following information is displayed: <pre>% Generating 512 bit RSA1 keys ...[fail] % Generating 512 bit RSA keys ...[fail]</pre> |
| <p>Verification</p> | <ul style="list-style-type: none"> ● Run the show crypto key mypubkey rsa command to display the public information about the RSA key. If the public information about the RSA key exists, the RSA key has been generated. |
| <p>SSH Server</p> | <pre>Ruijie(config)#show crypto key mypubkey rsa % Key pair was generated at: 1:49:47 UTC Jan 4 2013 Key name: RSA1 private Usage: SSH Purpose Key Key is not exportable. Key Data: AAAAAwEA AQAAAHJM 6izXt1pp rUSOEGZ/ UhFpRRrW nngP4BU7 mG836apf jajSYwcU 8O3LojHL ayJ8G4pG 7j4T4ZSf FKg09kfr 92JpRNHQ gbwaPc5/ 9UnTtX9t qFIKDj1j 0dKBcCfN tr0r/CT+ cs5tlGKV S0ICGifz oB+pYaE= % Key pair was generated at: 1:49:47 UTC Jan 4 2013 Key name: RSA private Usage: SSH Purpose Key Key is not exportable. Key Data:</pre> |

```
AAAAAwEAAQAAAHJfLwKnzOgO F3RIKhTN /7PmQYoE v0a2VXTX 8ZCa7SII EghLDLJc
w3T5JQXk Rr3iBD5s b1EeOL4b 21ykZt/u UetQ0Q80 sISglfZ9 8o5No3Zz MPM0LnQR
G4c7/28+ GOHzYkTk 4liQuTIL HRgtbyEYXCFaaxU=
```

▾ Specifying the SSH Version

| | |
|----------------------------|--|
| Configuration Steps | <ul style="list-style-type: none"> Run the ip ssh version { 1 2 } command to set the version supported by the SSH server to SSHv2. |
| SSH Server | <pre>Ruijie#configure terminal Ruijie(config)#ip ssh version 2</pre> |
| Verification | <ul style="list-style-type: none"> Run the show ip ssh command to display the SSH version currently supported by the SSH server. |
| SSH Server | <pre>Ruijie(config)#show ip ssh SSH Enable - version 2.0 Authentication timeout: 120 secs Authentication retries: 3 SSH SCP Server: disabled</pre> |

▾ Configuring the SSH Authentication Timeout

| | |
|----------------------------|---|
| Configuration Steps | <ul style="list-style-type: none"> Run the ip ssh time-out <i>time</i> command to set the SSH authentication timeout to 100s. |
| SSH Server | <pre>Ruijie#configure terminal Ruijie(config)#ip sstime-out100</pre> |
| Verification | <ul style="list-style-type: none"> Run the show ip ssh command to display the configured SSH authentication timeout. |
| SSH Server | <pre>Ruijie(config)#show ip ssh SSH Enable - version 2.0 Authentication timeout: 100 secs Authentication retries: 3 SSH SCP Server: disabled</pre> |

▾ Configuring the Maximum Number of SSH Authentication Retries

| | |
|----------------------------|--|
| Configuration Steps | <ul style="list-style-type: none"> Run the ip ssh authentication-retries <i>retry times</i> command to set the maximum number of user authentication retries on the SSH server to 2. |
| SSH Server | <pre>Ruijie#configure terminal</pre> |

| | |
|---------------------|--|
| | <pre>Ruijie(config)#ip ssh authentication-retries 2</pre> |
| Verification | <ul style="list-style-type: none"> Run the show ip ssh command to display the configured maximum number of authentication retries. |
| SSH Server | <pre>Ruijie(config)#show ip ssh SSH Enable - version 2.0 Authentication timeout: 100 secs Authentication retries: 3 SSH SCP Server: disabled</pre> |

↘ **Configuring the Public Key Authentication**

| | |
|----------------------------|--|
| Configuration Steps | <ul style="list-style-type: none"> Run the ip ssh peer <i>username</i> public-key { <i>rsa</i> <i>dsa</i> } <i>filename</i> command to associate a public key file of the client with a user name. When the client is authenticated upon login, a public key file (for example, RSA) is specified based on the user name. |
| SSH Server | <pre>Ruijie#configure terminal Ruijie(config)# ip ssh peer test public-key rsaflash:rsa.pub</pre> |
| Verification | <ul style="list-style-type: none"> Configure the public key authentication login mode on the SSH client and specify the private key file. Check whether you can successfully log in to the SSH server from the SSH client. If yes, the public key file on the client is successfully associated with the user name, and public key authentication succeeds. |

↘ **Configuring SSH Device Management**

| | |
|---|---|
| <p>Scenario Figure 14-6</p> |  <p>The diagram illustrates the SSH device management scenario. On the left, an icon of a laptop represents the 'SSH Client' with IP address '192.168.23.83'. A line connects it to a central cloud icon representing the 'IP Network'. Another line connects the cloud to a server rack icon representing the 'SSH Server' with IP address '192.168.23.122'.</p> <p>You can use SSH to manage devices on the precondition that the SSH server function is enabled. By default, this function is disabled. The Telnet component that comes with the Windows does not support SSH. Therefore, a third-party client software must be used. Currently, well-compatible client software includes PuTTY, Linux, and SecureCRT. The following takes the PuTTY as an example to introduce the configurations of the SSH client.</p> |
| Configuration Steps | <ul style="list-style-type: none"> Start the PuTTY software. On the Session option tab of PuTTY, type in the host IP address 192.168.23.122 and SSH port number 22, and select the connection type SSH. On the SSH option tab of PuTTY, select the preferred SSH protocol version 2. On the SSH authentication option tab of PuTTY, select the authentication method Attempt "keyboard-interactive" auth. |

- Click **Open** to connect to the SSH server.
- Type in the correct user name and password to enter the terminal login interface.

SSH Client

Figure 14-7

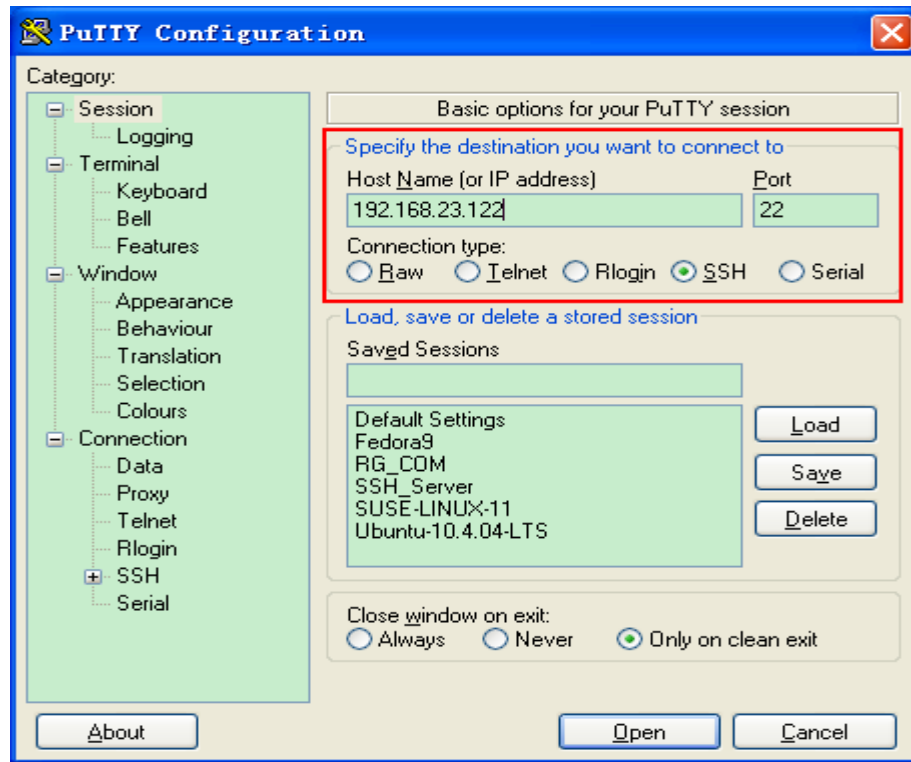

Host Name (or IP address) indicates the IP address of the host to be logged in. In this example, the IP address is **192.168.23.122**. **Port** indicates the port ID 22, that is, the default ID of the port listened by SSH. **Connection type** is **SSH**.

Figure 14-8

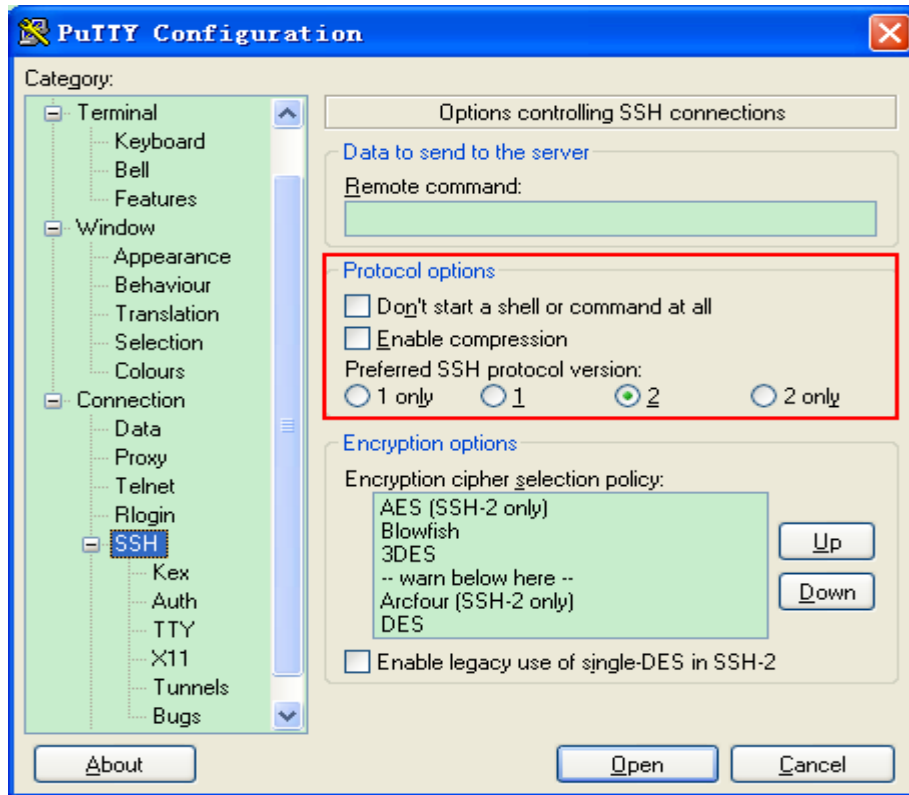

As shown in Figure 14-8, select **2** as the preferred SSH protocol version in the **Protocol options** pane because SSHv2 is used for login.

Figure 14-9

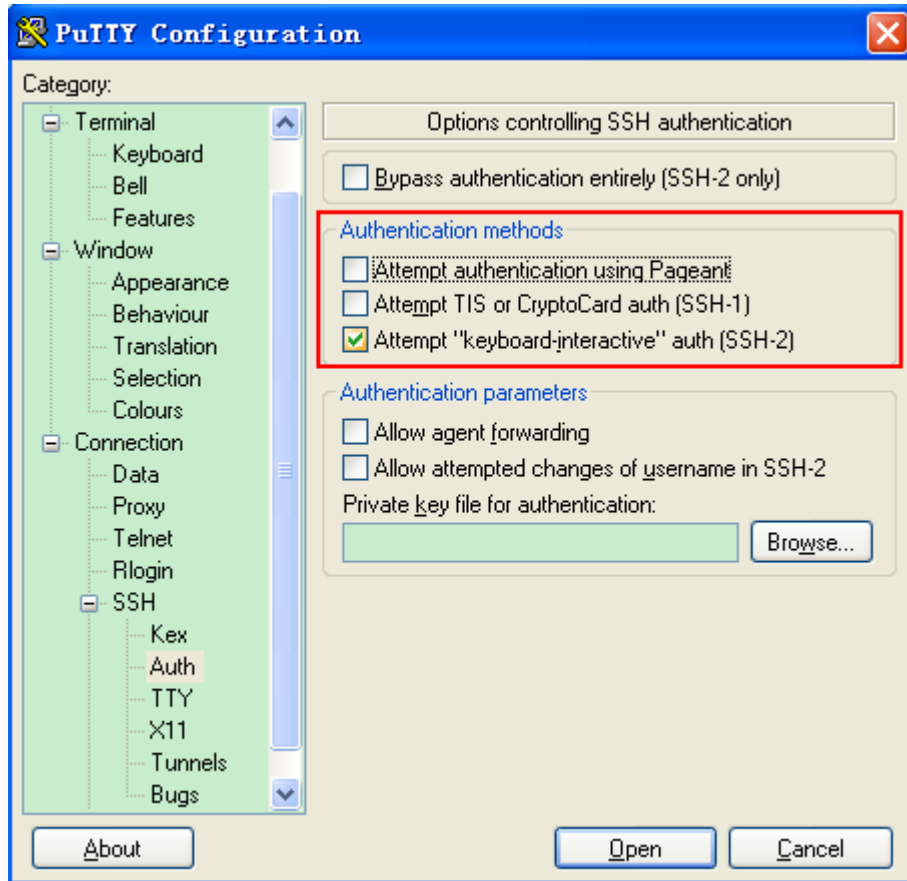

As shown in Figure 14-9, select **Attempt "keyboard-interactive" auth** as the authentication method to support authentication based on the user name and password.

Then, click **Open** to connect to the configured server host, as shown in Figure 14-9.

Figure 14-10

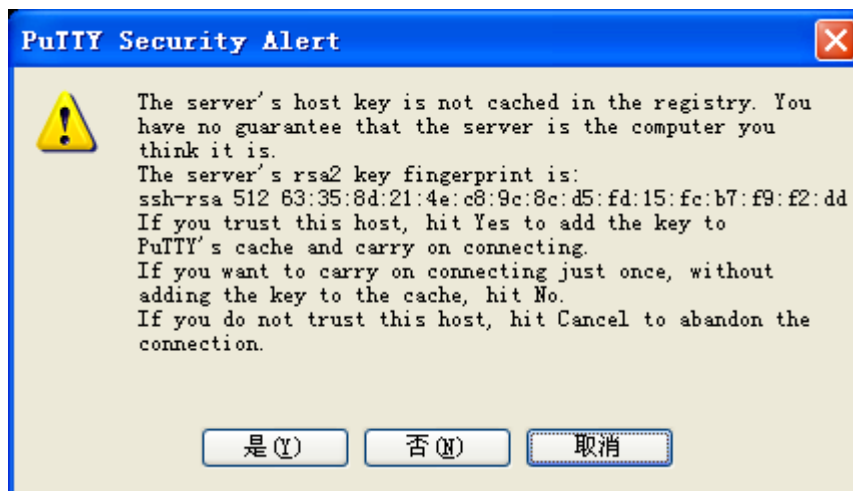

The **PuTTY Security Alert** box indicates that you are logging in to the client of the server 192.168.23.122, and asks you whether to receive the key sent from the server.

If you select **Yes**, a login dialog box is displayed, as shown in Figure 14-10.

Figure 14-11

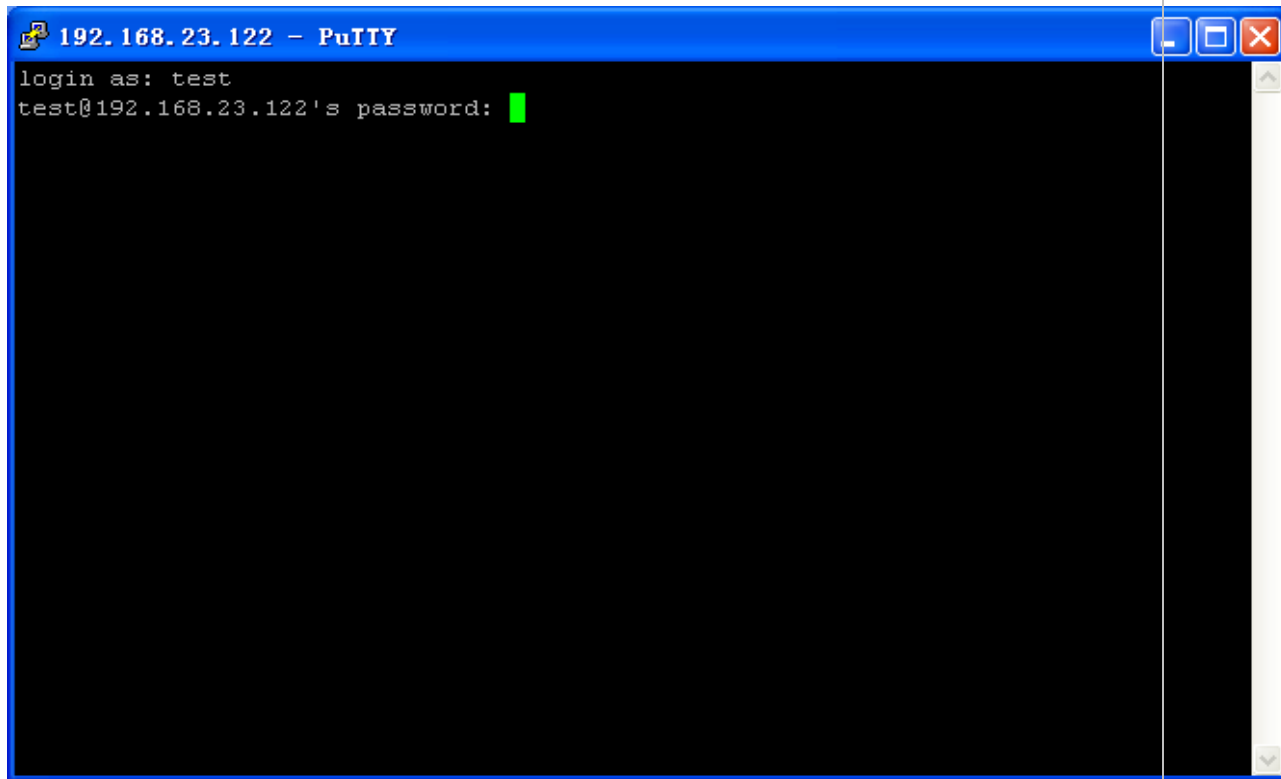

Type in the correct user name and password, and you can log in to the SSH terminal interface, as shown in Figure 14-11.

Figure 14-12

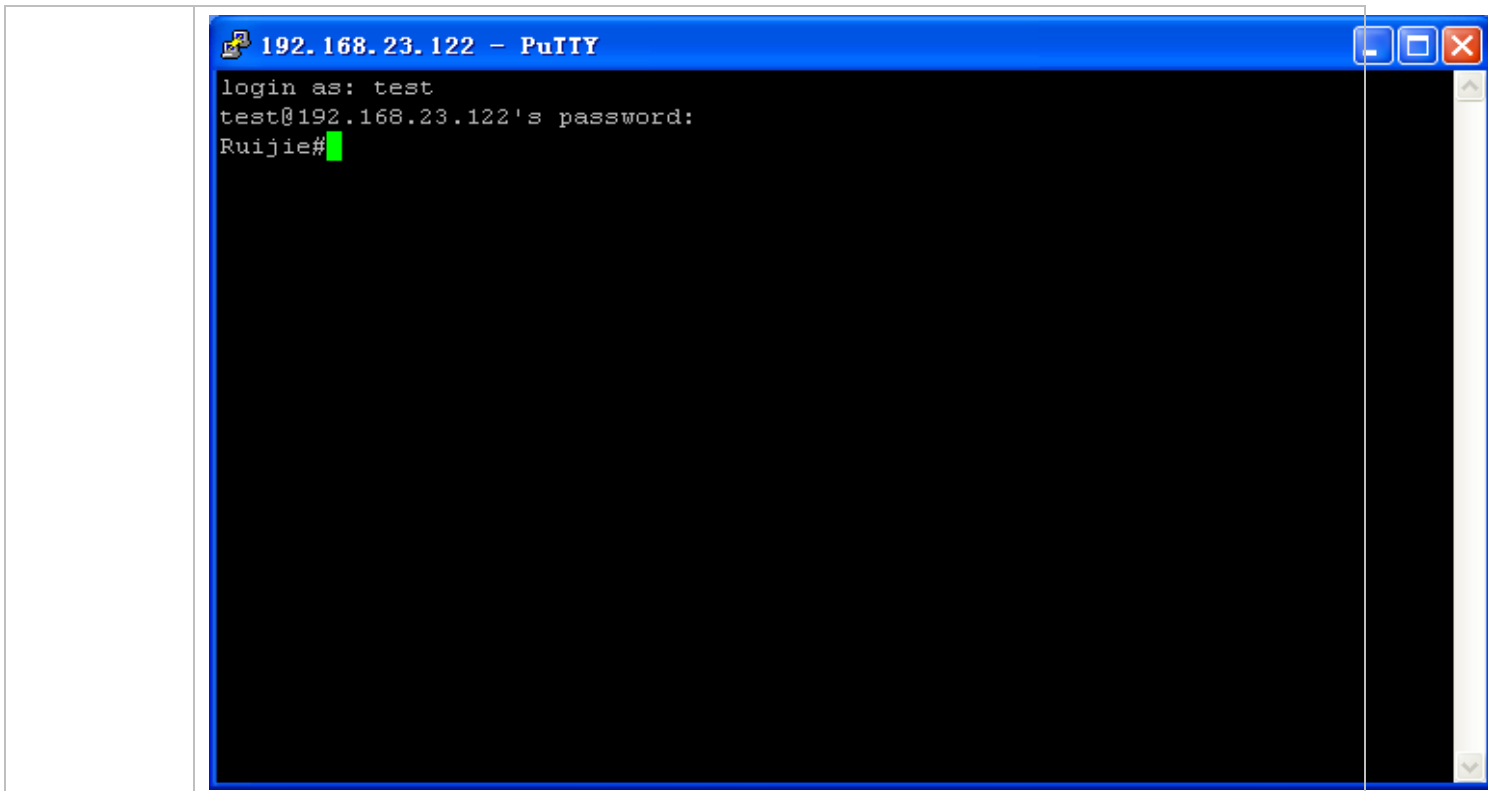

- Verification**
- Run the **show ip ssh** command to display the configurations that are currently effective on the SSH server.
 - Run the **show ssh** command to display information about every SSH connection that has been established.

```
Ruijie#show ip ssh
SSH Enable - version 1.99
Authentication timeout: 120 secs
Authentication retries: 3

Ruijie#show ssh
Connection Version Encryption      Hmac      State      Username
-----
0      2.0 aes256-cbc      hmac-sha1  Session started test
```

➤ [Configuring SSH Local Line Authentication](#)

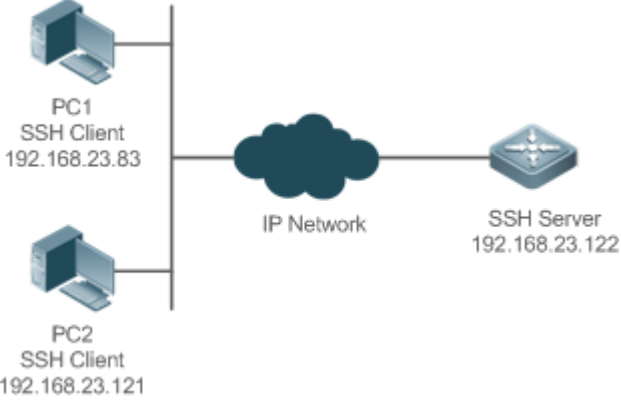
| | |
|--|---|
| <p>Scenario Figure 14-13</p> |  <p>SSH users can use the local line password for user authentication, as shown in Figure 15-12. To ensure security of data exchange, PC 1 and PC 2 function as the SSH clients, and use the SSH protocol to log in to the network device where the SSH server is enabled. The requirements are as follows:</p> <ul style="list-style-type: none"> ● SSH users use the local line password authentication mode. ● Five lines, including Line 0 to Line 4, are activated concurrently. The login password is "passzero" for Line 0 and "pass" for the remaining lines. Any user name can be used. |
| <p>Configuration Steps</p> | <p>Configure the SSH server as follows:</p> <ul style="list-style-type: none"> ● Enable the SSH server function globally. By default, the SSH server supports two SSH versions: SSHv1 and SSHv2. ● Configure the key. With this key, the SSH server decrypts the encrypted password received from the SSH client, compares the decrypted plain text with the password stored on the server, and returns a message indicating the successful or unsuccessful authentication. SSHv1 uses the RSA key, whereas SSHv2 uses the RSA or DSA key. ● Configure the IP address of the FastEthernet 0/1 interface on the SSH server. The SSH client is connected to the SSH server based on this IP address. The route from the SSH client to the SSH server is reachable. <p>Configure the SSH client as follows:</p> <ul style="list-style-type: none"> ● Diversified SSH client software is available, including PuTTY, Linux, and SecureCRT. This document takes PuTTY as an example to explain the method for configuring the SSH client. For details about the configuration method, see "Configuration Steps." |
| <p>SSH Server</p> | <p>Before configuring SSH-related function, ensure that the route from the SSH user to the network segment of the SSH server is reachable. The interface IP address configurations are shown in Figure 15-12. The detailed procedures for configuring IP addresses and routes are omitted.</p> <pre>Ruijie(config)# enable service ssh-server Ruijie(config)#crypto key generate rsa % You already have RSA keys. % Do you really want to replace them? [yes/no]: Choose the size of the key modulus in the range of 360 to 2048 for your</pre> |

| | |
|-------------------------------------|--|
| | <pre>Signature Keys. Choosing a key modulus greater than 512 may take a few minutes. How many bits in the modulus [512]: % Generating 512 bit RSA1 keys ...[ok] % Generating 512 bit RSA keys ...[ok] Ruijie(config)#interface fastEthernet0/1 Ruijie(config-if-fastEthernet0/1)#ip address 192.168.23.122 255.255.255.0 Ruijie(config-if-fastEthernet0/1)#exit Ruijie(config)#line vty 0 Ruijie(config-line)#password passzero Ruijie(config-line)#privilege level 15 Ruijie(config-line)#login Ruijie(config-line)#exit Ruijie(config)#line vty1 4 Ruijie(config-line)#password pass Ruijie(config-line)#privilege level 15 Ruijie(config-line)#login Ruijie(config-line)#exit</pre> |
| SSH Client(PC1/ PC2) | Figure 14-14 |

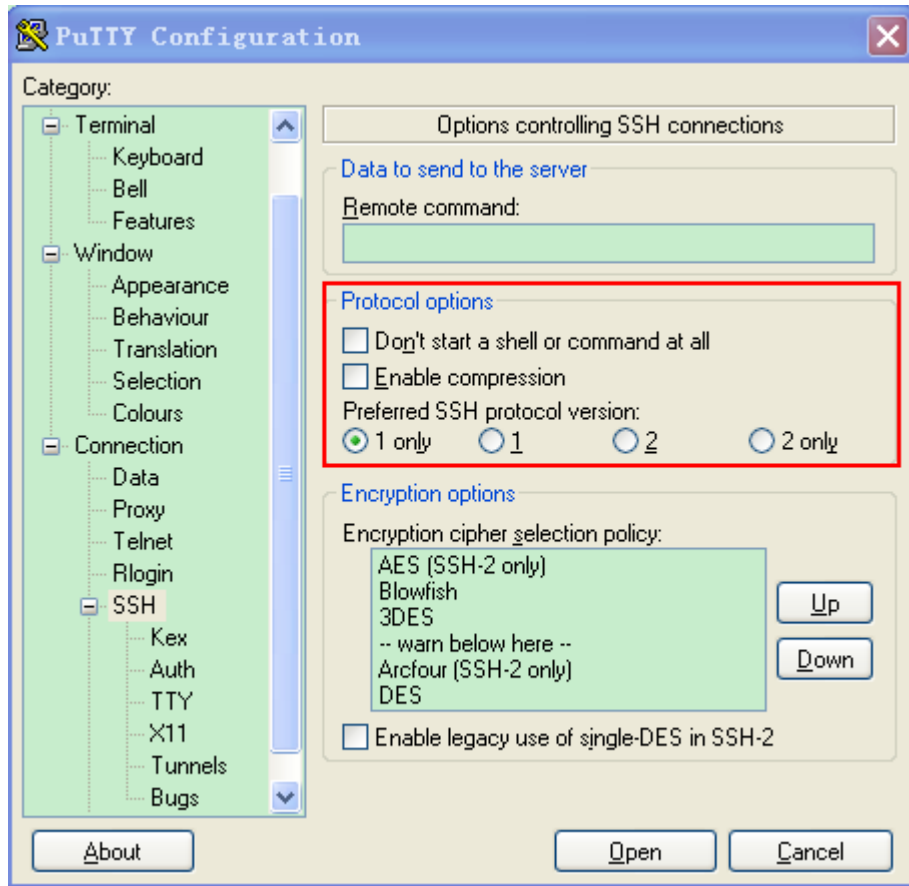

Set the IP address and port ID of the SSH server. As shown in the network topology, the IP address of the server is 192.168.23.122, and the port ID is 22 (For details about the configuration method, see "Configuring SSH Device Management."). Click **Open** to start the SSH server. As the current authentication mode does not require a user name, you can type in any user name, but cannot leave the user name unspecified. (In this example, the user name is "anyname".)

Verification

- Run the **show running-config** command to display the current configurations.
- Verify that the SSH client configurations are correct.

SSH Server

```
Ruijie#show running-config
Building configuration...
!
enable secret 5 $1$eyy2$xs28FDw4s2q0tx97
enable service ssh-server
!
interface fastEthernet0/1
ip address 192.168.23.122 255.255.255.0
```

```

!
line vty 0
privilege level 15
login
password passzero
line vty 1 4
privilege level 15
login
password pass
!
end
    
```

SSH Client

Set up a connection, and enter the correct password. The login password is "passzero" for Line 0 and "pass" for the remaining lines. Then, the SSH server operation interface is displayed, as shown in Figure 15-14

Figure 14-15

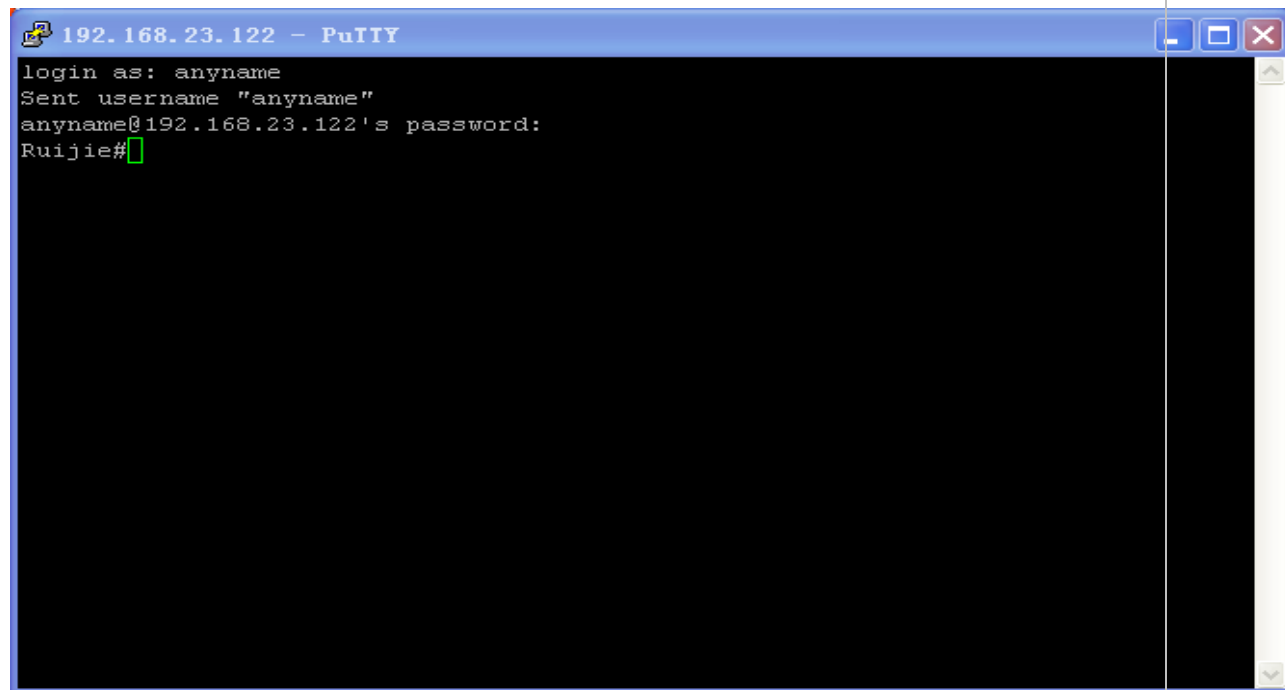

```
Ruijie#show users
```

| Line | User | Host(s) | Idle | Location |
|-----------|------|---------|----------|----------|
| ----- | | | | |
| * 0 con 0 | --- | idle | 00:00:00 | --- |

| | | | | |
|---------|-----|------|----------|----------------|
| 1 vty 0 | --- | idle | 00:08:02 | 192.168.23.83 |
| 2 vty 1 | --- | idle | 00:00:58 | 192.168.23.121 |

➤ **Configuring AAA Authentication of SSH Users**

Scenario
Figure 14-16

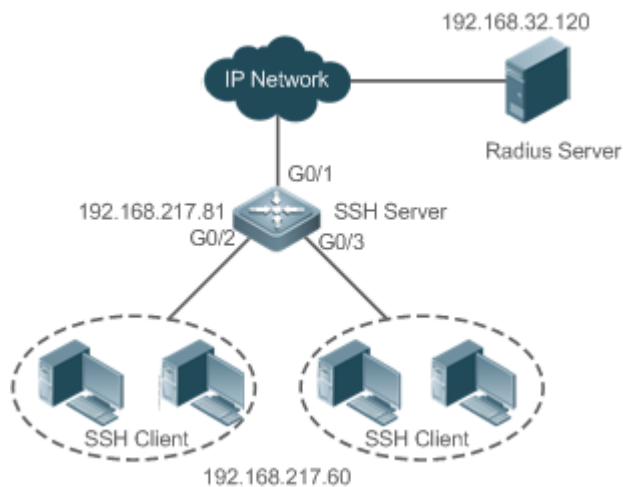

SSH users can use the AAA authentication mode for user authentication, as shown in Figure 15-15. To ensure security of data exchange, the PC functions as the SSH client, and uses the SSH protocol to log in to the network device where the SSH server is enabled. To better perform security management, the AAA authentication mode is used on the user login interface of the SSH client. Two authentication methods, including Radius server authentication and local authentication, are provided in the AAA authentication method list to ensure reliability. The Radius server authentication method is preferred. If the Radius server does not respond, select the local authentication method.

Configuration Steps

- The route from the SSH client to the SSH server is reachable, and the route from the SSH server to the Radius server is also reachable.
- Configure the SSH server on the network device. The configuration method is already described in the previous example, and therefore omitted here.
- Configure the AAA parameters on the network device. When the AAA authentication mode is used, method lists are created to define the identity authentication and types, and applied to a specified service or interface.

SSH Server

```
Ruijie(config)# enable service ssh-server
Ruijie(config)#crypto key generate rsa
% You already have RSA keys.
% Do you really want to replace them? [yes/no]:
Choose the size of the key modulus in the range of 360 to 2048 for your
Signature Keys. Choosing a key modulus greater than 512 may take
```

| | |
|----------------------------|--|
| | <pre> a few minutes. How many bits in the modulus [512]: % Generating 512 bit RSA1 keys ...[ok] % Generating 512 bit RSA keys ...[ok] Ruijie(config)#crypto key generate dsa Choose the size of the key modulus in the range of 360 to 2048 for your Signature Keys. Choosing a key modulus greater than 512 may take a few minutes. How many bits in the modulus [512]: % Generating 512 bit DSA keys ...[ok] Ruijie(config)#interface gigabitEthernet1/1 Ruijie(config-if-gigabitEthernet1/1)#ip address 192.168.217.81 255.255.255.0 Ruijie(config-if-gigabitEthernet1/1)#exit Ruijie#configure terminal Ruijie(config)#aaa new-model Ruijie(config)#radius-server host 192.168.32.120 Ruijie(config)#radius-server key aaaradius Ruijie(config)#aaa authentication login methodgroup radius local Ruijie(config)#line vty 0 4 Ruijie(config-line)#login authentication method Ruijie(config-line)#exit Ruijie(config)#username user1 privilege 1 password 111 Ruijie(config)#username user2 privilege 10 password 222 Ruijie(config)#username user3 privilege 15 password 333 Ruijie(config)#enable secret w </pre> |
| <p>Verification</p> | <ul style="list-style-type: none"> ● Run the show running-config command to display the current configurations. ● This example assumes that the SAM server is used. ● Set up a remote SSH connection on the PC. ● Check the login user. |
| | <pre> Ruijie#show run aaa new-model </pre> |

```
!  
aaa authentication login method group radius local  
  
!  
username user1 password 111  
username user2 password 222  
username user2 privilege 10  
username user3 password 333  
username user3 privilege 15  
  
no service password-encryption  
  
!  
radius-server host 192.168.32.120  
radius-server key aaaradius  
enable secret 5 $1$hbz$ArCsyqy6yyzpz03  
enable service ssh-server  
  
!  
interface gigabitEthernet1/1  
    no ip proxy-arp  
ip address 192.168.217.81 255.255.255.0  
  
!  
ip route 0.0.0.0 0.0.0.0 192.168.217.1  
  
!  
line con 0  
line vty 0 4  
    login authentication method  
  
!  
End
```

On the SSH client, choose **System Management>Device Management**, and add the device IP address **192.168.217.81** and the device key **aaaradius**.

Choose **Security Management>Device Management Rights**, and set the rights of the login user.

Choose **Security Management>Device Administrator**, and add the user name **user** and password **pass**.

Configure the SSH client and set up a connection to the SSH server. For details, see the previous example.

Type in the user name **user** and password **pass**. Verify that you can log in to the SSH server successfully.

```
Ruijie#show users
```

| Line | User | Host(s) | Idle | Location |
|-----------|------|---------|----------|----------------|
| 0 con 0 | | idle | 00:00:31 | |
| * 1 vty 0 | user | idle | 00:00:33 | 192.168.217.60 |

↘ **Configuring Public Key Authentication of SSH Users**

| | |
|---|---|
| <p>Scenario Figure 14-17</p> |  <p>SSH Client 192.168.23.83</p> <p>IP Network</p> <p>SSH Server 192.168.23.122</p> <p>SSH users can use the public key for user authentication, and the public key algorithm is RSA or DSA, as shown in Figure 15-16. SSH is configured on the client so that a secure connection is set up between the SSH client and the SSH server.</p> |
| <p>Configuration Steps</p> | <ul style="list-style-type: none"> To implement public key authentication on the client, generate a key pair (for example, RSA key) on the client, place the public key on the SSH server, and select the public key authentication mode. <p>i After the key pair is generated on the client, you must save and upload the public key file to the server and complete the server-related settings before you can continue to configure the client and connect the client with the server.</p> <ul style="list-style-type: none"> After the key is generated on the client, copy the public key file from the client to the flash of the SSH server, and associate the file with an SSH user name. A user can be associated with one RSA public key and one DSA public key. |
| <p>SSH Client</p> | <p>Run the puttygen.exe software on the client. Select SSH-2 RSA in the Parameters pane, and click Generate to generate a key, as shown in Figure 14-18.</p> <p>Figure 14-18</p> |



When a key is being generated, you need to constantly move the mouse over a blank area outside the green progress bar; otherwise, the progress bar does not move and key generation stops, as shown in Figure 14-19.

Figure 14-19

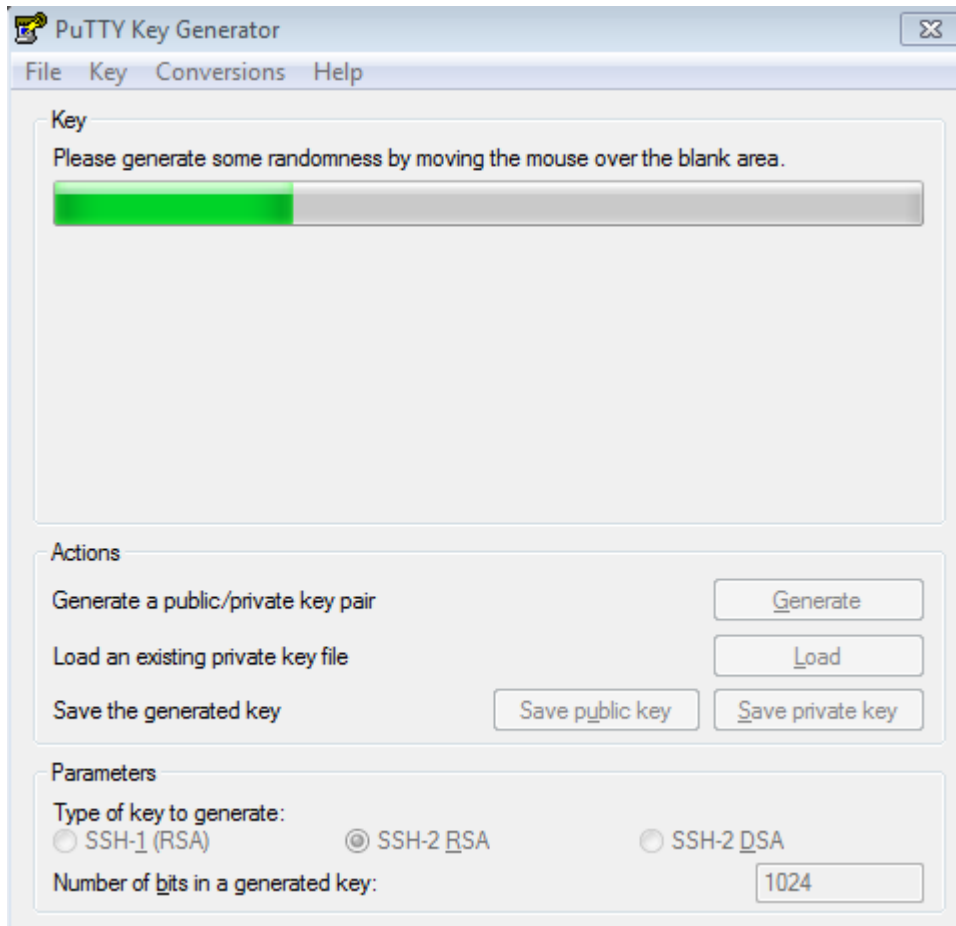

To ensure security of the RSA public key authentication, the length of the generated RSA key pair must be equal to or larger than 768 bits. In this example, the length is set to 1024 bits.

Figure 14-20

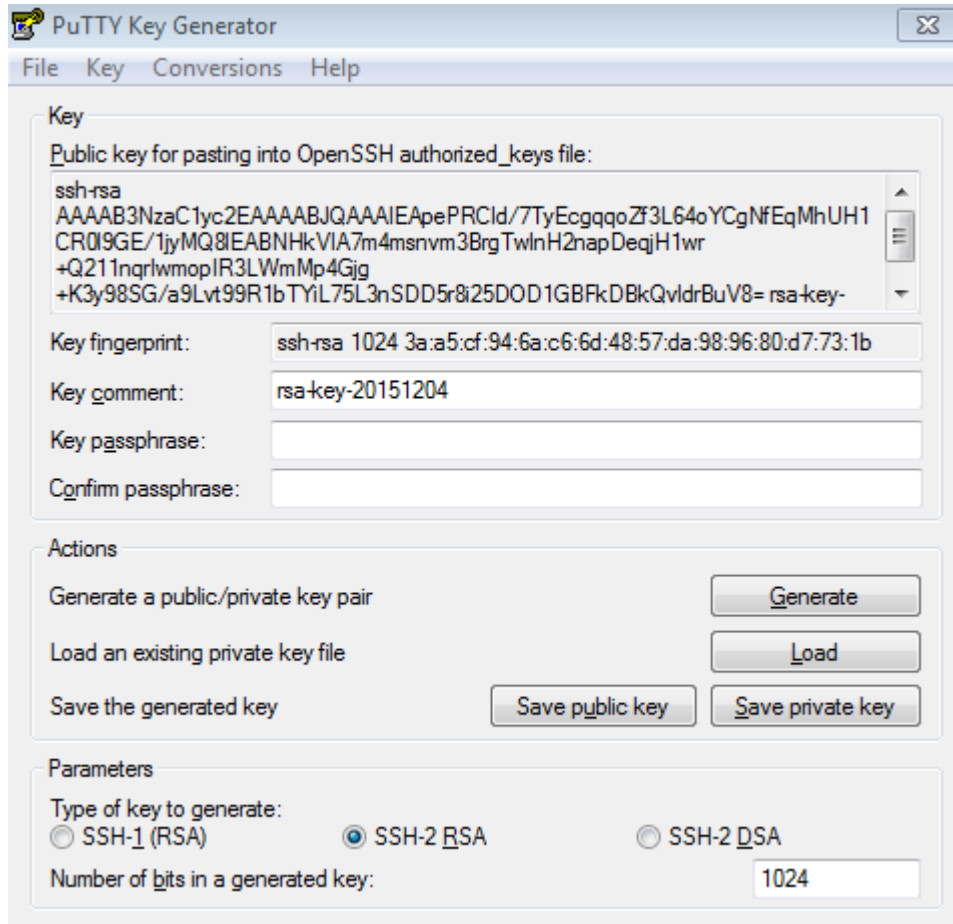

After the key pair is generated, click **Save public key**, type in the public key name **test_key.pub**, select the storage path, and click **Save**. Then click **Save private key**. The following prompt box is displayed. Select **Yes**, type in the public key name **test_private**, and click **Save**.

Figure 14-21

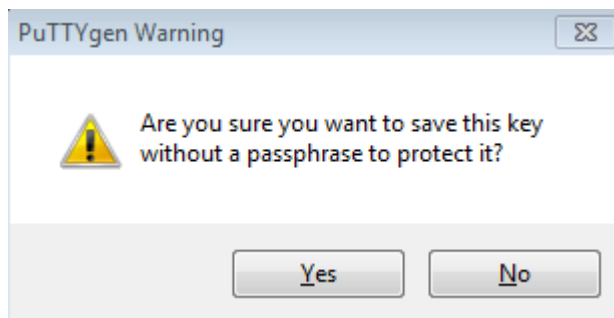

You must select the OpenSSH key file; otherwise, the key file cannot be used. The **puttygen.exe** software can be used to generate a key file in OpenSSH format, but this file cannot be directly used by the PuTTY client. You must use **puttygen.exe** to convert the private key to the PuTTY format. Format conversion is not required for the public key file stored on the server, and the format of this file is still OpenSSH, as shown in Figure 14-22.

Figure 14-22

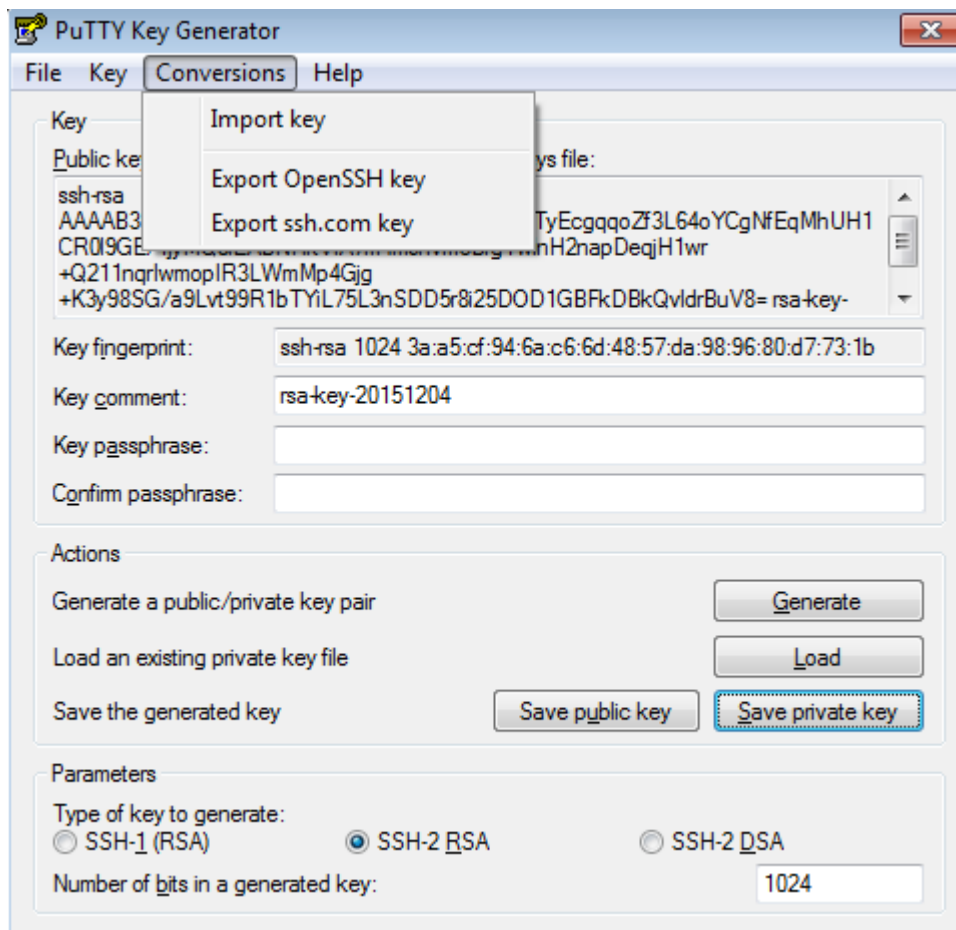

| | |
|----------------------------|---|
| <p>SSH Server</p> | <pre>Ruijie#configure terminal Ruijie(config)# ip ssh peer test public-key rsaflash:test_key.pub</pre> |
| <p>Verification</p> | <ul style="list-style-type: none"> After completing the basic configurations of the client and the server, specify the private key file test_private on the PuTTY client, and set the host IP address to 192.168.23.122 and port ID to 22 to set up a connection between the client and the server. In this way, the client can use the public key authentication mode to log in to the network device. |
| <p>Figure 14-23</p> | |

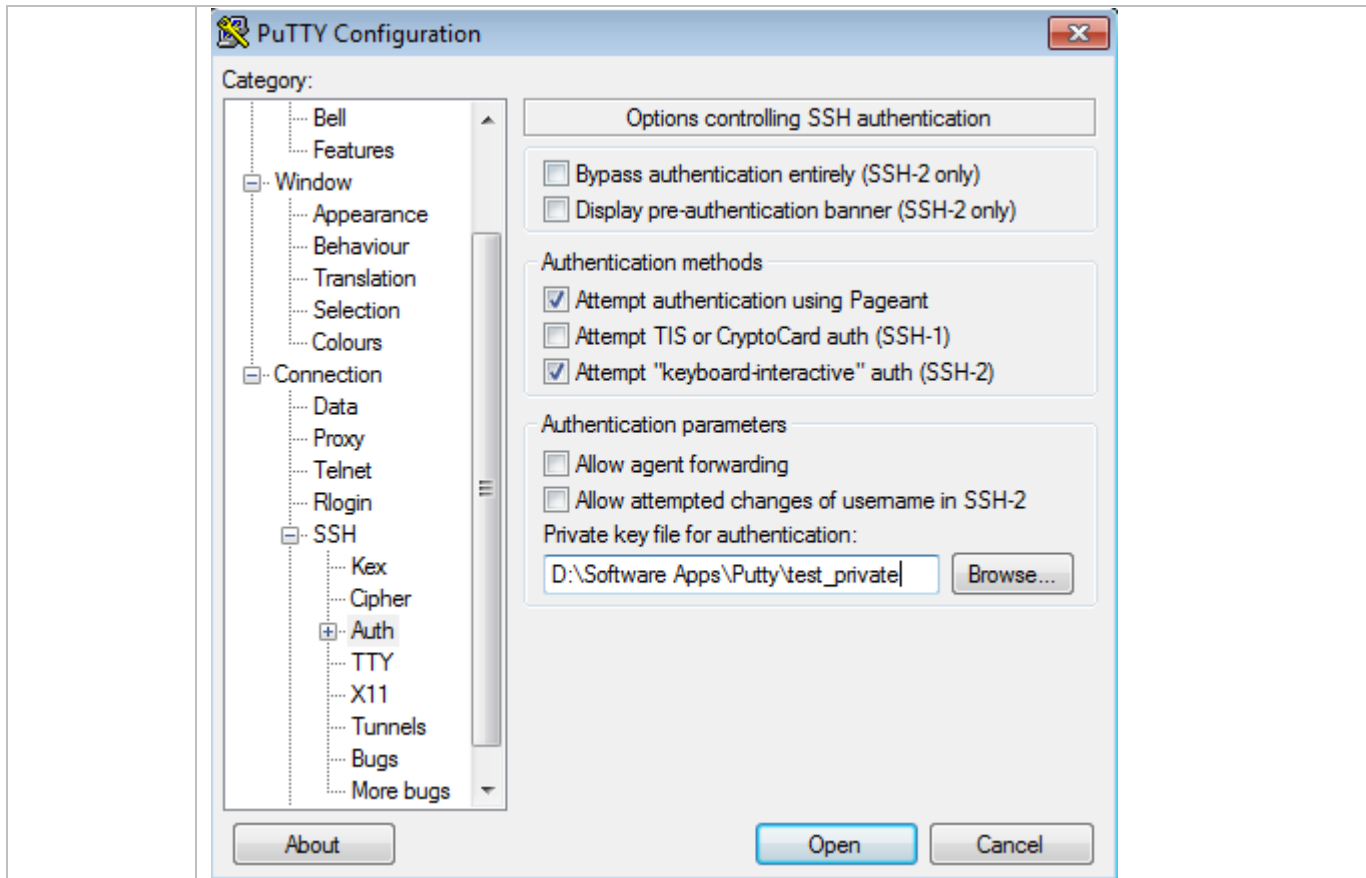

Common Errors

- The `no crypto key generate` command is used to delete a key.

14.4.2 Configuring the SCP Service

Configuration Effect

After the SCP function is enabled on a network device, you can directly download files from the network device and upload local files to the network device. In addition, all interactive data is encrypted, featuring authentication and security.

Notes

- The SSH server must be enabled in advance.

Configuration Steps

↳ Enabling the SCP Server

- Mandatory.
- By default, the SCP server function is disabled. Run the `ip scp server enable` command to enable the SCP server function in global configuration mode.

Verification

Run the **show ip ssh** command to check whether the SCP server function is enabled.

Related Commands

↳ Enabling the SCP Server

| | |
|---------------------|---|
| Command | ip scp server enable |
| Parameter | N/A |
| Description | |
| Command Mode | Global configuration mode |
| Usage Guide | This command is used to enable the SCP server. Run the no ip scp server enable command to disable the SCP server. |

Configuration Example

↳ Enabling the SCP Server

| | |
|----------------------------|---|
| Configuration Steps | <ul style="list-style-type: none"> Run the ip scp server enable command to enable the SCP server. <pre>Ruijie#configure terminal Ruijie(config)#ip scp server enable</pre> |
| Verification | <ul style="list-style-type: none"> Run the show ip ssh command to check whether the SCP server function is enabled. <pre>Ruijie(config)#show ipssh SSH Enable - version 1.99 Authentication timeout: 120 secs Authentication retries: 3 SSH SCP Server: enabled</pre> |

↳ Configuring SSH File Transfer

| | |
|--|---|
| Scenario Figure 14-24 | <p>SSH Client 192.168.23.83 IP Network SSH Server 192.168.23.122</p> <p>The SCP service is enabled on the server, and SCP commands are used on the client to transfer data to the server.</p> |
| Configuration | <ul style="list-style-type: none"> Enable the SCP service on the server. |

| | |
|---------------------|---|
| Steps | <p>i The SCP server uses SSH threading. When connecting to a network device for SCP transmission, the client occupies a VTY session (You can find out that the user type is SSH by running the show user command).</p> <ul style="list-style-type: none"> On the client, use SCP commands to upload files to the server, or download files from the server. <p>Syntax of the SCP command:</p> <pre>scp [-1246BCpqr] [-c cipher] [-F ssh_config] [-i identity_file] [-l limit] [-o ssh_option] [-P port] [-S program] [[user@]host1:]file1 [...] [[user@]host2:]file2</pre> <p>Descriptions of some options:</p> <ul style="list-style-type: none"> -1: Uses SSHv1 (If not specified, SSHv2 is used by default); -2: Uses SSHv2 (by default); -C: Uses compressed transmission. -c: Specifies the encryption algorithm to be used. -r: Transmits the whole directory; -i: Specifies the key file to be used. -l: Limits the transmission speed (unit: Kbit/s). <p>For other parameters, see the filescp.0.</p> <p>Most options are related to terminals. Few options are supported on both terminals and servers. Ruijie's SCP servers do not support d-p-q-r options. When these options are applied, there are prompts.</p> |
| SSH Server | <pre>Ruijie#configure terminal Ruijie(config)# ip scp server enable</pre> |
| Verification | <ul style="list-style-type: none"> File transmission example on the Ubuntu 7.10 system: <p>Set the username of a client to test and copy the config.text file from the network device with the IP address of 192.168.195.188 to the /root directory on the local device.</p> |
| | <pre>root@dhcpd:~#scp test@192.168.23.122:/config.text /root/config.text test@192.168.195.188's password: config.text 100% 1506 1.5KB/s 00:00 Read from remote host 192.168.195.188: Connection reset by peer</pre> |

14.5 Monitoring

Displaying

| Description | Command |
|--|---------------------------------|
| Displays the effective SSH server configurations. | show ipssh |
| Displays the established SSH connection. | show ssh |
| Displays the public information of the SSH public key. | show crypto key mypubkey |

Debugging



System resources are occupied when debugging information is output. Therefore, disable debugging immediately after use.

| Description | Command |
|----------------------|------------------|
| Debugs SSH sessions. | debug ssh |



System Configuration

1. Configuring CLI
2. Configuring Basic Management
3. Configuring Lines
4. Configuring RMON
5. Configuring SNMP
6. Configuring HTTP Service
7. Configuring Syslog
8. Configuring RLOG
9. Configuring CWMP
10. Configuring LED
11. Configuring USB
12. Configuring PKG_MGMT
13. Configuring NTP
14. Configuring SNTP

15. Configuring Time Range

1 Configuring CLI

1.1 Overview

The command line interface (CLI) is a window used for text command interaction between users and network devices. You can enter commands in the CLI window to configure and manage network devices.

1.2 Applications

Protocols and Standards

N/A

1.3 Applications

| Application | Description |
|--|--|
| Configuring and Managing Network Devices Through CLI | You can enter commands in the CLI window to configure and manage network devices |

1.3.1 Configuring and Managing Network Devices Through CLI

Scenario

As shown in Figure 1-1, a user accesses network device A using a PC, and enter commands in the CLI window to configure and manage the network device.

Figure 1-1



| | |
|----------------|---|
| Remarks | A is the network device to be managed. PC is a terminal. |
|----------------|---|

Deployment

As shown in Figure 1-2, the user uses the Secure CRT installed on a PC to set up a connection with network device A, and opens the CLI window to enter configuration commands.

Figure 1-2

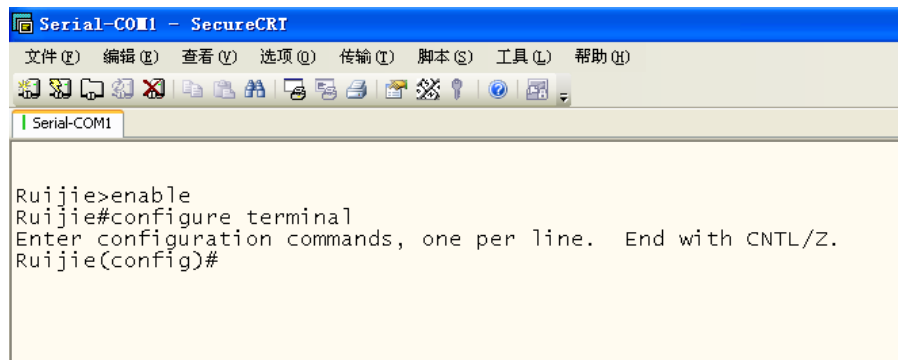

1.4 Features

Overview

| Feature | Description |
|--|--|
| Accessing CLI | You can log in to a network device for configuration and management. |
| Command Modes | The CLI provides several command modes. Commands that can be used vary according to command modes. |
| System Help | You can obtain the help information of the system during CLI configuration. |
| Abbreviated Commands | If the entered string is sufficient to identify a unique command, you do not need to enter the full string of the command. |
| No and Default Options of Commands | You can use the no option of a command to disable a function or perform the operation opposite to the command, or use the default option of the command to restore default settings. |
| Prompts Indicating Incorrect Commands | An error prompt will be displayed if an incorrect command is entered. |
| History Commands | You can use short-cut keys to display or call history commands. |
| Featured Editing | The system provides short-cut keys for editing commands. |
| Searching and Filtering of the Show Command Output | You can run the show command to search or filter specified commands. |
| Command Alias | You can configure alias of a command to replace the command. |

1.4.1 Accessing CLI

Before using the CLI, you need to connect a terminal or PC to a network device. You can use the CLI after starting the network device and finishing hardware and software initialization. When used for the first time, the network device can be connected only through the console port, which is called out band management. After performing relevant configuration, you can connect and manage the network device through Telnet.

1.4.2 Command Modes

Due to the large number of commands, these commands are classified by function to facilitate the use of commands. The CLI provides several commands modes, and all commands are registered in one or several command modes. You must first enter the command mode of a command before using this command. Different command modes are related with each other while distinguished from each other.

As soon as a new session is set up with the network device management interface, you enter User EXEC mode. In this mode, you can use only a small number of commands and the command functions are limited, such as the **show** commands. Execution results of commands in User EXEC mode are not saved.

To use more commands, you must first enter Privileged EXEC mode. Generally, you must enter a password to enter Privileged EXEC mode. In Privileged EXEC mode, you can use all commands registered in this command mode, and further enter global configuration mode.

Using commands of a certain configuration mode (such as global configuration mode and interface configuration mode) will affect configuration in use. If you save the configuration, these commands will be saved and executed next time the system is restarted. You must enter global configuration mode before entering another configuration mode, such as interface configuration mode.

The following table summarizes the command modes by assuming that the name of the network device is "Ruijie".

| Command Mode | Access Method | Prompt | Exit or Entering Another Mode | About |
|---|---|---------|---|---|
| User EXEC (User EXEC mode) | Enter User EXEC mode by default when accessing a network device. | Ruijie> | Run the exit command to exit User EXEC mode. Run the enable command to enter Privileged EXEC mode. | Use this command mode to conduct basic tests or display system information. |
| Privileged EXEC (Privileged EXEC mode) | In User EXEC mode, run the enable command to enter Privileged EXEC mode. | Ruijie# | Run the disable command to return to User EXEC mode. Run the configure command to enter global configuration mode. | Use this command mode to check whether the configuration takes effect. This mode is password protected. |

| Command Mode | Access Method | Prompt | Exit or Entering Another Mode | About |
|---|--|----------------------|--|--|
| Global configuration (Global configuration mode) | In Privileged EXEC mode, run the configure command to enter global configuration mode. | Ruijie(config)# | Run the exit or end command, or press Ctrl+C to return to Privileged EXEC mode. Run the interface command to enter interface configuration mode. When using the interface command, you must specify the interface. Run the vlan <i>vlan_id</i> command to enter VLAN configuration mode. | Using commands in this mode will affect the global parameters of the network device. |
| Interface configuration (Interface configuration mode) | In global configuration mode, run the interface command to enter interface configuration mode. | Ruijie(config-if)# | Run the end command, or press Ctrl+C to return to Privileged EXEC mode. Run the exit command to return to global configuration mode. When using the interface command, you must specify the interface. | Use this configuration mode to configure various interfaces of the network device. |
| Config-vlan (VLAN configuration mode) | In global configuration mode, run the vlan <i>vlan_id</i> command to enter VLAN configuration mode. | Ruijie(config-vlan)# | Run the end command, or press Ctrl+C to return to the Privileged EXEC mode. Run the exit command to return to global configuration mode. | Use this configuration mode to configure VLAN parameters. |

1.4.3 System Help

When entering commands in the CLI window, you can obtain the help information using the following methods:

- At the command prompt in any mode, enter a question mark (?) to list the commands supported by the current command mode and related command description.

For example

```
Ruijie>?
```

```
Exec commands:
```

```

<1-99>      Session number to resume
disable     Turn off privileged commands
disconnect  Disconnect an existing network connection
enable      Turn on privileged commands
exit        Exit from the EXEC
help        Description of the interactive help system
lock        Lock the terminal
ping        Send echo messages
show        Show running system information
telnet      Open a telnet connection
traceroute  Trace route to destination

```

2. Enter a space and a question mark (?) after a keyword of a command to list the next keyword or variable associated with the keyword.

For example

```

Ruijie(config)#interface ?
Aggregateport  Aggregate port interface
Dialer         Dialer interface
GigabitEthernet Gigabit Ethernet interface
Loopback       Loopback interface
Multilink      Multilink-group interface
Null           Null interface
Tunnel         Tunnel interface
Virtual-ppp    Virtual PPP interface
Virtual-template Virtual Template interface
Vlan           Vlan interface
range         Interface range command

```



If the keyword is followed by a parameter value, the value range and description of this parameter are displayed as follows:

```

Ruijie(config)#interface vlan ?
<1-4094> Vlan port number

```

3. Enter a question mark (?) after an incomplete string of a command keyword to list all command keywords starting with the string.

For example

```
Ruijie#d?  
debug delete diagnostic dir disable disconnect
```

4. After an incomplete command keyword is entered, if the suffix of this keyword is unique, press the **Tab** key to display the complete keyword.

For example

```
Ruijie# show conf<Tab>  
Ruijie# show configuration
```

5. In any command mode, run the **help** command to obtain brief description about the help system.

For example

```
Ruijie(config)#help  
Help may be requested at any point in a command by entering  
a question mark '?'. If nothing matches, the help list will  
be empty and you must backup until entering a '?' shows the  
available options.  
Two styles of help are provided:  
1. Full help is available when you are ready to enter a  
command argument (e.g. 'show ?') and describes each possible  
argument.  
2. Partial help is provided when an abbreviated argument is entered  
and you want to know what arguments match the input  
(e.g. 'show pr?'.)
```

1.4.4 Abbreviated Commands

If a command is long, you can enter a part of the command that is sufficient to identify the command keyword.

For example, to run the **interface** *gigabitEthernet 0/1* command in GigabitEthernet 0/1 interface configuration mode, enter the abbreviated command as follows:

```
Ruijie(config)#int g0/1  
Ruijie(config-if-GigabitEthernet 0/1)#
```

1.4.5 No and Default Options of Commands

Most commands have the **no** option. Generally, the **no** option is used to disable a feature or function, or perform the operation opposite to the command. For example, run the **no shutdown** command to perform the operation opposite to the **shutdown**

command, that is, enabling the interface. The keyword without the **no** option is used to enable a disabled feature or a feature that is disabled by default.

Most configuration commands have the **default** option. The **default** option is used to restore default settings of the command. Default values of most commands are used to disable related functions. Therefore, the function of the **default** option is the same as that of the **no** option in most cases. For some commands, however, the default values are used to enable related functions. In this case, the function of the **default** option is opposite to that of the **no** option. At this time, the **default** option is used to enable the related function and set the variables to default values.

 For specific function of the **no** or **default** option of each command, see the command reference.

1.4.6 Prompts Indicating Incorrect Commands

When you enter an incorrect command, an error prompt is displayed.

The following table lists the common CLI error messages.

| Error Message | Meaning | How to Obtain Help |
|---|---|---|
| % Ambiguous command: "show c" | The characters entered are insufficient for identifying a unique command. | Re-enter the command, and enter a question mark after the word that is ambiguous. All the possible keywords will be displayed. |
| % Incomplete command. | The mandatory keyword or variable is not entered in the command. | Re-enter the command, and enter a space and a question mark. All the possible keywords or variables will be displayed. |
| % Invalid input detected at '^' marker. | An incorrect command is entered. The sign (^) indicates the position of the word that causes the error. | At the current command mode prompt, enter a question mark. All the command keywords allowed in this command mode will be displayed. |

1.4.7 History Commands

The system automatically saves commands that are entered recently. You can use short-cut keys to display or call history commands.

The methods are described in the following table.

| Operation | Result |
|------------------------|--|
| Ctrl+P or the UP key | Display the previous command in the history command list. Starting from the latest record, you can repeatedly perform this operation to query earlier records. |
| Ctrl+N or the DOWN key | After pressing Ctrl+N or the DOWN key, you can return to a command that is recently executed in the history command list. You can repeatedly perform this operation to query recently executed commands. |

 The standard terminals, such as the VT100 series, support the direction keys.

1.4.8 Featured Editing

When editing the command line, you can use the keys or short-cut keys listed in the following table:

| Function | Key or Short-Cut Key | Description |
|--|----------------------|---|
| Move the cursor on the editing line. | Left key or Ctrl+B | Move the cursor to the previous character. |
| | Right key or Ctrl+B | Move the cursor to the next character. |
| | Ctrl+A | Move the cursor to the head of the command line. |
| | Ctrl+E | Move the cursor to the end of the command line. |
| Delete an entered character. | Backspace key | Delete one character to the left of the cursor. |
| | Delete key | Delete one character to the right of the cursor. |
| Move the output by one line or one page. | Return key | When displaying contents, press the Return key to move the output one line upward and display the next line. This operation is performed when the output does not end yet. |
| | Space key | When displaying contents, press the Space key to page down and display the next page. This operation is performed when the output does not end yet. |

When the editing cursor is close to the right boundary, the entire command line will move to the left by 20 characters, and the hidden front part is replaced by the dollar (\$) signs. You can use the related keys or short-cut keys to move the cursor to the characters in the front or return to the head of the command line.

For example, the whole **access-list** may exceed the screen width. When the cursor is close to the end of the command line for the first time, the entire command line moves to the left by 20 characters, and the hidden front part is replaced by the dollar signs (\$). Each time the cursor is close to the right boundary, the entire command line moves to the left by 20 characters.

```
access-list 199 permit ip host 192.168.180.220 host
$ost 192.168.180.220 host 202.101.99.12
$0.220 host 202.101.99.12 time-range tr
```

Press **Ctrl+A** to return to the head of the command line. At this time, the hidden tail part of the command line is replaced by the dollar signs (\$).

```
access-list 199 permit ip host 192.168.180.220 host 202.101.99.$
```

 The default screen width is 80 characters.

1.4.9 Searching and Filtering of the Show Command Output

To search specified contents from the output of the **show** command, run the following command:

| Command | Description |
|--|---|
| show any-command begin regular-expression | Searches specified contents from the output of the show command. The first line containing the contents and all information that follows this line will be output. |

 The **show** command can be executed in any mode.

 Searched contents are case sensitive.

To filter specified contents from the output of the **show** command, run the following commands:

| Command | Description |
|---|--|
| show <i>any-command</i> exclude <i>regular-expression</i> | Filters the output of the show command. Except those containing the specified contents, all lines will be output. |
| show <i>any-command</i> include <i>regular-expression</i> | Filters the output of the show command. Only the lines containing the specified contents will be output. |

To search or filter the output of the **show** command, you must enter a vertical line (|). After the vertical line, select the searching or filtering rules and contents (character or string). Searched and filtered contents are case sensitive.

```
Ruijie#show running-config | include interface
interface GigabitEthernet 0/0
interface GigabitEthernet 0/1
interface GigabitEthernet 0/2
interface GigabitEthernet 0/3
interface GigabitEthernet 0/4
interface GigabitEthernet 0/5
interface GigabitEthernet 0/6
interface GigabitEthernet 0/7
interface Mgmt 0
```

1.4.10 Command Alias

You can configure any word as the alias of a command to simplify the command input.

Configuration Effect

1. Replace a command with a word.

For example, configure "mygateway" as the alias of the **ip route** *0.0.0.0 0.0.0.0 192.1.1.1* command. To run this command, you only need to enter "mygateway".

2. Replace the front part of a command with a word, and enter the later part.

For example, configure "ia" as the alias of the **ip address** command. To run this command, you need to enter "ia" and then the specified IP address and subnet mask.

Configuration Steps

📌 Displaying Default Alias

In User EXEC or Privileged EXEC mode, default alias are available for some commands. You can run the **show aliases** command to display these default aliases.

```
Ruijie(config)#show aliases
Exec mode alias:
```

| | |
|----|---------|
| h | help |
| p | ping |
| s | show |
| u | undebug |
| un | undebug |

i These default aliases cannot be deleted.

▾ Configuring a Command Alias

| | |
|------------------------------|---|
| Command | alias <i>mode command-alias original-command</i> |
| Parameter Description | <i>mode</i> : indicates the command mode of the command represented by the alias. <i>command-alias</i> : indicates the command alias. <i>original-command</i> : indicates the command represented by the alias. |
| Command Mode | Global configuration mode |
| Usage Guide | In global configuration mode, run the alias ? command to list all command modes that can be configured with aliases. |

▾ Displaying Settings of Command Aliases

Run the **show aliases** command to display alias settings in the system.

Notes

- The command replaced by an alias must start from the first character of the command line.
- The command replaced by an alias must be complete.
- The entire alias must be entered when the alias is used; otherwise, the alias cannot be identified.

Configuration Example

▾ Defining an Alias to Replace the Entire Command

| | |
|----------------------------|--|
| Configuration Steps | In global configuration mode, configure the alias "ir" to represent the default route configuration command ip route 0.0.0.0 0.0.0.0 192.168.1.1 . |
| | <pre>Ruijie#configure terminal Ruijie(config)#alias config ir ip route 0.0.0.0 0.0.0.0 192.168.1.1</pre> |
| Verification | <ul style="list-style-type: none"> ● Run the show alias command to check whether the alias is configured successfully. <pre>Ruijie(config)#show alias Exec mode alias: h help</pre> |

| | |
|--|---|
| | <pre> p ping s show u undebug un undebug Global configuration mode alias: ir ip route 0.0.0.0 0.0.0.0 192.168.1.1 </pre> |
| | <ul style="list-style-type: none"> ● Use the configured alias to run the command, and run the show running-config command to check whether the alias is configured successfully. |
| | <pre> Ruijie(config)#ir Ruijie(config)#show running-config Building configuration... ! alias config ir ip route 0.0.0.0 0.0.0.0 192.168.1.1 //Configuring an alias ... ip route 0.0.0.0 0.0.0.0 192.168.1.1 //Configuration result after the alias "ir" is entered ! </pre> |

➤ **Defining an Alias to Replace the Front Part of a Command**

| | |
|----------------------------|--|
| Configuration Steps | In global configuration mode, configure the alias "ir" to represent the front part "ip route" of the default route configuration command. |
| | <pre> Ruijie#configure terminal Ruijie(config)#alias config ir ip route </pre> |
| Verification | <ul style="list-style-type: none"> ● Run the show alias command to check whether the alias is configured successfully. <pre> Ruijie(config)#show alias Exec mode alias: h help p ping s show u undebug un undebug </pre> |

| | |
|--|--|
| | <pre>Global configuration mode alias: ir ip route</pre> |
| | <ul style="list-style-type: none"> ● Enter the alias "ir" and then the later part of the command "0.0.0.0 0.0.0.0 192.168.1.1". ● Run the show ap-config running command to check whether the configuration is successful. |
| | <pre>Ruijie(config)#ir 0.0.0.0 0.0.0.0 192.168.1.1 Ruijie(config)#show running Building configuration... ! alias config ir ip route //Configuring an alias ! ip route 0.0.0.0 0.0.0.0 192.168.1.1 //Configuration result after the alias "ir" and the later part of the command are entered !</pre> |

System Help

1. The system provides help information for command alias. An asterisk (*) will be displayed in front of an alias. The format is as follows:

```
*command=alias=original-command
```

For example, in Privileged EXEC mode, the default command alias "s" represents the **show** keyword. If you enter "s?", the keywords starting by "s" and alias information are displayed.

```
Ruijie#s?
*s=show show start-chat start-terminal-service
```

2. If the command represented by an alias contains more than one word, the command is displayed in a pair of quotation marks.

For example, in Privileged EXEC mode, configure the alias "sv" to replace the **show version** command. If you enter "s?", the keywords starting by "s" and alias information are displayed.

```
Ruijie#s?
*s=show *sv="show version" show start-chat
start-terminal-service
```

3. You can use the alias to obtain help information about the command represented by the alias.

For example, configure the alias "ia" to represent the **ip address** command in interface configuration mode. If you enter "ia?" in interface configuration mode, the help information on "ip address?" is displayed, and the alias is replaced by the command.

```
Ruijie(config-if)#ia ?  
  A. B. C. D  IP address  
  dhcp      IP Address via DHCP  
Ruijie(config-if)#ip address
```

 If you enter a space in front of a command, the command represented by this alias will not be displayed.

2 Configuring Basic Management

2.1 Overview

This document is a getting started guide to network device management. It describes how to manage, monitor, and maintain network devices.

2.2 Applications

| Application | Description |
|---|---|
| Network Device Management | A user logs in to a network device from a terminal and runs commands on a command line interface (CLI) to manage device configurations. |

2.2.1 Network Device Management

Scenario

Network device management described in this document is performed through the CLI. A user logs in to Network Device A from a terminal and runs commands on the CLI to manage device configurations. See Figure 2-1.

Figure 2-1



2.3 Features

Basic Concepts

↳ TFTP

Trivial File Transfer Protocol (TFTP) is a TCP/IP protocol which allows a client to transfer a file to a server or get a file from a server.

↳ AAA

AAA is short for Authentication, Authorization and Accounting.

Authentication refers to the verification of user identities and the related network services.

Authorization refers to the granting of network services to users according to authentication results.

Accounting refers to the tracking of network service consumption by users. A billing system charges users based on consumption records.

➤ RADIUS

Remote Authentication Dial In User Service (RADIUS) is the most widely used AAA protocol at present.

➤ Telnet

Telnet is a terminal emulation protocol in the TCP/IP protocol stack which provides access to a remote host through a virtual terminal connection. It is a standard protocol located at Layer 7 (application layer) of the Open System Interconnection (OSI) model and used on the internet for remote login. Telnet sets up a connection between the local PC and a remote host.

➤ System Information

System information includes the system description, power-on time, hardware and software versions, control-layer software version, and boot-layer software version.

➤ Hardware Information

Hardware information includes the physical device information as well as slot and module information. The device information includes the device description and slot quantity. The slot information includes the slot ID, module description (which is empty if a slot does not have a module), and actual and maximum number of physical ports.

Overview

| Feature | Description |
|--|---|
| User Access Control | Controls the terminal access to network devices on the internet based on passwords and privileges. |
| Login Authentication Control | Performs username-password authentication to grant access to network devices when AAA is enabled. (Authentication is performed by a dedicated server.) |
| Basic System Parameters | Refer to the parameters of a system, such as the clock, banner, and Console baud rate. |
| Displaying Configurations | Displays the system configurations, including the configurations that the system is currently running and the device configurations stored in the nonvolatile random access memory (NVRAM). |
| Telnet | Telnet is an application-layer protocol in the TCP/IP protocol stack. It provides the standard governing remote login and virtual terminal communication on the internet. |
| Restart | Introduces system restart. |

2.3.1 User Access Control

User access control refers to the control of terminal access to network devices on the internet based on passwords and privileges.

Working Principle

▾ Privilege Level

16 privilege levels are defined ranging from 0 to 15 for CLI on network devices to grant users access to different commands. Level 0 is the lowest level granting access to just a few commands, whereas level 15 is the highest level granting access to all commands. Levels 0 and 1 are common user levels without the device configuration permission (users are not allowed to enter global configuration mode by default). Levels 2–15 are privileged user levels with the device configuration permission.

▾ Password Classification

Passwords are classified into two types: password and security. The first type refers to simple encrypted passwords at level 15. The second type refers to secure encrypted passwords at levels 0–15. If a level is configured with both simple and secure encrypted passwords, the simple encrypted password will not take effect. If you configure a non-15 level simple encrypted password, a warning is displayed and the password is automatically converted into a secure encrypted password. If you configure the same simple encrypted password and secure encrypted password at level 15, a warning is displayed.

▾ Password Protection

Each privilege level on a network device has a password. An increase in privilege level requires the input of the target level password, whereas a reduction in privilege level does not require password input.

By default, only two privilege levels are password-protected, namely, level 1 (common user level) and level 15 (privileged user level). Sixteen privilege levels with password protection can be assigned to the commands in each mode to grant access to different commands.

If no password is configured for a privileged user level, access to this level does not require password input. It is recommended that a password be configured for security purposes.

▾ Command Authorization

Each command has its lowest execution level. A user with a privilege level lower than this level is not allowed to run the command. After the command is assigned a privilege level, users at this level and higher have access to the command.

Related Configuration

▾ Configuring a Simple Encrypted Password

- Run the **enable password** command.

▾ Configuring a Secure Encrypted Password

- Run the **enable secret** command.
- A secure encrypted password is used to control the switching between user levels. It has the same function as a simple encrypted password but uses an enhanced password encryption algorithm. Therefore, secure encrypted passwords are recommended out of security consideration.

▾ Configuring Command Privilege Levels

- Run the **privilege** command to assign a privilege level to a command.
- A command at a lower level is accessible by more users than a command at a higher level.

↘ Raising/Lowering a User Privilege Level

- Run the **enable** command or the **disable** command to raise or lower a user privilege level respectively.
- After logging in to a network device, the user can change his/her level to obtain access to commands at different privilege levels.

↘ Enabling Line Password Protection

- Line password protection is required for remote login (such as login through Telnet).
- Run the **password[0 | 7] line** command to configure a line password, and then run the **login** command to enable password protection.
- By default, terminals do not support the **lock** command.

2.3.2 Login Authentication Control

In login authentication with AAA disabled, the password entered by a user is checked against the configured line password. If they are consistent, the user can access the network device. In local authentication, the username and password entered by a user are checked against those stored in the local user database. If they are matched, the user can access the network device with proper management permissions.

In AAA, the username and password entered by a user are authenticated by a server. If authentication is successful, the user can access the network device and enjoy certain management permissions.

For example, a RADIUS server can be used to authenticate usernames and passwords and control users' management permissions on network devices. Network devices no longer store users' passwords, but send encrypted user information to the RADIUS server, including usernames, passwords, shared passwords, and access policies. This provides a convenient way to manage and control user access and improve user information security.

Working Principle

↘ Line Password

If AAA is disabled, you can configure a line password used to verify user identities during login. After AAA is enabled, line password verification does not take effect.

↘ Local Authentication

If AAA is disabled, you can configure local authentication to verify user identities and control management permissions by using the local user database. After AAA is enabled, local authentication does not take effect.

↘ AAA

AAA provides three independent security functions, namely, Authentication, Authorization and Accounting. A server (or the local user database) is used to perform authentication based on the configured login authentication method list and control users' management permissions. For details about AAA, see *Configuring AAA*.

Related Configuration

▾ Configuring Local User Information

- Run the **username** command to configure the account used for local identity authentication and authorization, including usernames, passwords, and optional authorization information.

▾ Configuring Local Authentication for Line-Based Login

- Run the **login local** command (in the case that AAA is disabled).
- Perform this configuration on every device.

▾ Configuring AAA Authentication for Line-Based Login

- The default authentication method is used after AAA is enabled.
- Run the **login authentication** command to configure a login authentication method list for a line.
- Perform this configuration when the local AAA authentication is required.

▾ Configuring the Connection Timeout Time

- The default connection timeout time is 10 minutes.
- Run the **exec-timeout** command to change the default connection timeout time. An established connection will be closed if no output is detected during the timeout time.
- Perform this configuration when you need to increase or reduce the connection timeout time.

▾ Configuring the Session Timeout Time

- The default session timeout time is 0 minutes, indicating no timeout.
- Run the **session-timeout** command to change the default session timeout time.
- The session established to a remote host through a line will be disconnected if no output is detected during the timeout time. Then the remote host is restored to Idle. Perform this configuration when you need to increase or reduce the session timeout time.

▾ Locking a Session

- By default, terminals do not support the **lock** command.
- Run the **lockable** command to lock the terminals connected to the current line.
- To lock a session, first enable terminal lock in line configuration mode, and then run the **lock** command in terminal EXEC mode to lock the terminal.

2.3.3 Basic System Parameters

▾ System Time

The network device system clock records the time of events on the device. For example, the time shown in system logs is obtained from the system clock. Time is recorded in the format of *year-month-day, hour.minute:second, day of the week*.

When you use a network device for the first time, set its system clock to the current date and time manually.

↘ **Configuring a System Name and Command Prompt**

You can configure a system name to identify a network device. The default system name is **Ruijie**. A name with more than 32 characters will be truncated to keep only the first 32 characters. The command prompt keeps consistent with the system name.

↘ **Banner**

A banner is used to display login prompt information. There are two types of banner: Daily notification and login banner.

- Daily notification is displayed on all terminals connected to network devices soon after login. Urgent messages (such as immediate system shutdown) can be delivered to users through daily notification.
- A login banner appears after daily notification to display login information.

↘ **Configuring the Console Baud Rate**

You can manage network device through a Console port. The first configuration on the network device must be performed through the Console port. The serial port baud rate can be changed based on actual requirements. Note that the management terminal must have consistent baud rate setting with the device console.

↘ **Configuring the Connection Timeout Time**

The connection timeout time is used to control device connections (including established connections and sessions established to remote hosts). A connection will be closed when no input is detected during the timeout time.

Related Configuration

↘ **Configuring the System Date and Clock**

- Run the **clock set** command to configure the system time of a network device manually. The device clock starts from the configured time and keeps running even when the device is powered off.

↘ **Updating the Hardware Clock**

- If the hardware clock and software clock are not synchronized, run the **clock update-calendar** command to copy the date and time of the software clock to the hardware clock.

↘ **Configuring a System Name**

- Run the **hostname** command to change the default system name.
- The default host name is **Ruijie**.

↘ **Configuring a Command Prompt**

- Run the **prompt** command.

↘ **Configuring Daily Notification**

- By default, no daily notification is configured.

- Run the **banner motd** command to configure daily notification.
- Daily notification is displayed on all terminals connected to network devices soon after login. Urgent messages (such as immediate system shutdown) can be delivered to users through daily notification.

↘ **Configuring a Login Banner**

- By default, no login banner is configured.
- Run the **banner login** command to configure a login banner to display login information.

↘ **Configuring the Console Baud Rate**

- Run the **speed** command.
- The default baud rate is 9,600 bps.

2.3.4 Displaying Configurations

Displays the system configurations, including the configurations that the system is currently running and the device configurations stored in the NVRAM.

Working Principle

↘ **Running Configurations**

Running configurations, namely, running-config, are the configurations that individual component modules run in real time. A request can be made to all running components to collect configurations, which will be orchestrated before being displayed to users. Only running components may provide real-time configurations, whereas unloaded components do not display configurations. In the case that the system is started, a component process is restarted, and a hot patch is executed, the configurations collected during this period may be inaccurate due to the component unstable state. For example, the configurations of a component may not be missing initially but can be displayed later.

↘ **Startup Configurations**

The configurations stored in the NVRAM, namely, startup-config, are the configurations executed during device startup. When the system is restarted, startup-config is loaded to become new running-config. To display permanent configurations, the system needs to read the **startup-config** file in the NVRAM.

Related Configuration

↘ **Displaying Running Configurations**

Run the **show running-config [interface interface]** command to display the configurations that the system is currently running or the configurations on an interface.

↘ **Displaying Startup Configurations**

Run the **show startup-config** command.

↘ **Storing Startup Configurations**

Run the **write** or **copy running-config startup-config** command to store the current running configurations as new startup configurations.

2.3.5 Telnet

Working Principle

Telnet is an application-layer protocol in the TCP/IP protocol stack. It provides the standard governing remote login and virtual terminal communication on the internet.

The Telnet Client service allows a local or remote user who has logged in to a network device to use its Telnet Client program to access other remote system resources on the internet. In Figure 2-2, a user with a PC connects to Network Device A by using the terminal emulation or Telnet program and then logs in to Network Device B by using the **telnet** command to perform configuration management.

Ruijie Telnet program supports the use of IPv4 and IPv6 addresses. A Telnet server accepts Telnet connection requests that carry IPv4 and IPv6 addresses. A Telnet client can send connection requests to hosts identified by IPv4 and IPv6 addresses.

Figure 2-2

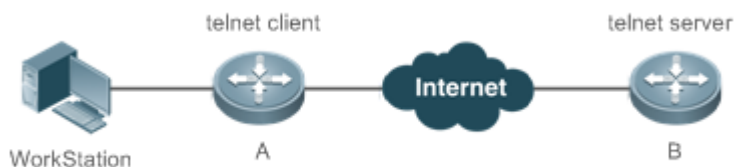

Related Configuration

▾ Enabling the Telnet Client Service

- Run the **telnet** command to log in to a remote device.

▾ Restoring a Telnet Client Session

- Run the **<1-99>** command.

▾ Disconnecting a Suspended Telnet Client Session

- Run the **disconnect session-id** command.

▾ Enabling the Telnet Server Service

- Run the **enable service telnet-server** command.
- Perform this configuration when you need to enable Telnet login.

2.3.6 Restart

The timed restart feature makes user operation easier in some scenarios (such as tests).

- If you configure a time interval, the system will restart after the interval. The interval is in the format of *mmm* or *hhh:mm*, in the unit of minutes. You can specify the interval name to reflect the restart purpose.
- If you define a future time, the system will restart when the time is reached.

 The clock feature must be supported by the system if you want to use the **at** option. It is recommended that you configure the system clock in advance. A new restart plan will overwrite the existing one. A restart plan will be invalid if the system is restarted before the plan takes effect.



 The span between the restart time and current time must not exceed 31 days, and the restart time must be later than the current system time. After you configure a restart plan, do not to change the system clock; otherwise, the plan may fail (for example, the system time is changed to a time after the restart time.)



Related Configuration

▾ Configuring Restart

- Run the **reload** command to configure a restart policy.
- Perform this configuration when you need to restart a device at a specific time.

2.4 Configuration

| | | |
|--|--|---|
| Configuring Passwords and Privileges |  (Optional) It is used to configure passwords and command privilege levels. | |
| | enable password | Configures a simple encrypted password. |
| | enable secret | Configures a secure encrypted password. |
| | enable | Raises a user privilege level. |
| | disable | Lowers a user privilege level. |
| | privilege | Configures command privilege levels. |
| | password | Specifies a line password. |
| | login | Enables line password protection. |
| Configuring Login and Authentication |  (Optional) It is used to configure different login modes and authentication methods. | |
| | username | Configures local user account information and optional authorization information. |
| | login local | Configures local authentication for line-based login. |
| | login authentication | Configures AAA authentication for line-based login. |
| | telnet | Enables the Telnet Client service. |
| | enable service telnet-server | Enables the Telnet Server service. |
| | exec-timeout | Configures the connection timeout time. |

| | | |
|---|---|---|
| | session-timeout | Configures the session timeout time. |
| | lockable | Enables line-based terminal lock. |
| | lock | Locks a terminal connected to the current line. |
| Configuring Basic System Parameters |  (Optional) It is used to configure basic system parameters. | |
| | clock set | Configures the system date and clock. |
| | clock update-calendar | Updates the hardware clock. |
| | hostname | Configures a system name. |
| | prompt | Configures a command prompt. |
| | banner motd | Configures daily notification. |
| | bannerlogin | Configures a login banner. |
| Enabling and Disabling a Specific Service |  (Optional) It is used to enable and disable a specific service. | |
| | enable service | Enables a service. |
| Configuring a Restart Policy |  (Optional) It is used to configure a system restart policy. | |
| | reload | Restarts a device. |

2.4.1 Configuring Passwords and Privileges

Configuration Effect

- Configure passwords to control users' access to network devices.
- Assign a privilege level to a command to grant the command access to only the users at or higher than the level.
- Lower the command privilege level to grant more users access to the command.
- Raise the command privilege level to limit the command access to a few users.

Notes

- You can use the password configuration command with the **level** option to configure a password for a specific privilege level. After you specify the level and the password, the password works for the users who need to access this level.
- By default, no password is configured for any level. The default level is 15.
- If you configure a simple encrypted password with a non-15 level, a warning is displayed and the password is automatically converted into a secure encrypted password.
- The system chooses the secure encrypted password over the simple encrypted password if both of them are configured.

Configuration Steps

▾ Configuring a Simple Encrypted Password

- (Optional) Perform this configuration when you need to establish simple encrypted password verification when users switch between different privilege levels.
- Run the **enable password** command to configure a simple encrypted password.

▾ Configuring a Secure Encrypted Password

- (Optional) Perform this configuration when you need to establish secure encrypted password verification when users switch between different privilege levels.
- Run the **enable secret** command to configure a secure encrypted password.
- A secure encrypted password has the same function as a simple encrypted password but uses an enhanced password encryption algorithm. Therefore, secure encrypted passwords are recommended out of security consideration.

▾ Configuring Command Privilege Levels

- Optional.
- A command at a lower level is accessible by more users than a command at a higher level.

▾ Raising/Lowering a User Privilege Level

- After logging in to a network device, the user can change his/her level to obtain access to commands at different privilege levels.
- Run the **enable** command or the **disable** command to raise or lower a user privilege level respectively.

▾ Enabling Line Password Protection

- (Optional) Line password protection is required for remote login (such as login through Telnet).
- Run the **password [0 | 7] line** command to configure a line password, and then run the **login** command to enable login authentication.

 If a line password is configured but login authentication is not configured, the system does not display password prompt.



Verification

- Run the **show privilege** command to display the current user level.
- Run the **show running-config** command to display the configuration.

Related Commands

▾ Configuring a Simple Encrypted Password

| | |
|--------------------|---|
| Command | enable password [level level] { password [0 7] encrypted-password } |
| Parameter | <i>level</i> : Indicates a specific user level. |
| Description | <i>password</i> : Indicates the password used to enter privileged EXEC mode. 0: Indicates that the password is entered in plaintext. 7: Indicates that the password is entered in cyphertext. |

| | |
|---------------------|--|
| | <p><i>encrypted-password</i>: Indicates the password text, which must contain case-sensitive English letters and digits.</p> <hr/> <p> Leading spaces are allowed, but will be ignored. However, intermediate and trailing spaces are recognized.</p> |
| Command Mode | Global configuration mode |
| Usage Guide | <p>Currently, simple encrypted passwords can be configured with only level 15 and take effect only when no secure encrypted password is configured.</p> <p>If you configure a simple encrypted password with a non-15 level, a warning is displayed and the password is automatically converted into a secure encrypted password.</p> <p>If the level 15 simple encrypted password and secure encrypted password are configured the same, a warning is displayed.</p> <hr/> <p> If you specify an encryption type and enter a password in plaintext, you cannot re-enter privileged EXEC mode. An encrypted password cannot be retrieved once lost. You have to configure a new password.</p> |

➤ **Configuring a Secure Encrypted Password**

| | |
|------------------------------|---|
| Command | enable secret [level <i>level</i>] {secret [0 5] <i>encrypted-secret</i> } |
| Parameter Description | <p><i>level</i>: Indicates a specific user level.</p> <p>secret: Indicates the password used to enter privileged EXEC mode.</p> <p>0 5: Indicates the password encryption type. 0 indicates no encryption, and 5 indicates secure encryption.</p> <p><i>encrypted-password</i>: Indicates the password text.</p> |
| Command Mode | Global configuration mode |
| Usage Guide | Use this command to configure passwords for different privilege levels. |

➤ **Raising a User Privilege Level**

| | |
|------------------------------|---|
| Command | enable [<i>privilege-level</i>] |
| Parameter Description | <i>privilege-level</i> : Indicates a specific privilege level. |
| Command Mode | Privileged EXEC mode |
| Usage Guide | An increase in privilege level requires the input of the target level password. |

➤ **Lowering a User Privilege Level**

| | |
|------------------------------|--|
| Command | disable [<i>privilege-level</i>] |
| Parameter Description | <i>privilege-level</i> : Indicates a specific privilege level. |

| | |
|---------------------|--|
| Command Mode | Privileged EXEC mode |
| Usage Guide | <p>A reduction in privilege level does not require password input.</p> <p>Use this command to exit Privileged EXEC mode and return to user EXEC mode. If <i>privilege-level</i> is specified, the current privilege level is reduced to the specified level.</p> <hr/> <p> <i>privilege-level</i> must be lower than the current level.</p> |

↘ **Configuring Command Privilege Levels**

| | |
|------------------------------|--|
| Command | privilege mode [all] { level level reset } command-string |
| Parameter Description | <p><i>mode</i>: Indicates the CLI mode of the command. For example, config indicates the global configuration mode, EXEC indicates the privileged command mode, and interface indicates the interface configuration mode.</p> <p>all: Changes the subcommand privilege levels of a specific command to the same level.</p> <p>level level: Indicates a privilege level, ranging from 0 to 15.</p> <p>reset: Restores the command privilege level to the default.</p> <p><i>command-string</i>: Indicates the command to be assigned a privilege level.</p> |
| Command Mode | Global configuration mode |
| Usage Guide | To restore a command privilege level, run the no privilege mode [all] level level command command in global configuration mode. |

↘ **Specifying a Line Password**

| | |
|------------------------------|---|
| Command | password[0 7] line |
| Parameter Description | <p>0: Indicates to configure a password in plaintext.</p> <p>7: Indicates to configure a password in cyphertext.</p> <p><i>line</i>: Indicates the password string.</p> |
| Command Mode | Line configuration mode |
| Usage Guide | N/A |

↘ **Enabling Line Password Protection**

| | |
|------------------------------|-------------------------|
| Command | login |
| Parameter Description | N/A |
| Command Mode | Line configuration mode |
| Usage Guide | N/A |

Configuration Example

▾ Configuring Command Authorization

| | |
|----------------------------|---|
| Scenario | Assign privilege level 1 to the reload command and its subcommands and configure level 1 as the valid level (by configuring the test password). |
| Configuration Steps | <ul style="list-style-type: none"> Assign privilege level 1 to the reload command and its subcommands. <pre>Ruijie# configure terminal Ruijie(config)# privilege exec all level 1 reload Ruijie(config)# enable secret level 1 0 test Ruijie(config)# end</pre> |
| Verification | <ul style="list-style-type: none"> Check whether the reload command and its subcommands are accessible at level 1. <pre>Ruijie# disable 1 Ruijie> reload ? at reload at<cr></pre> |

2.4.2 Configuring Login and Authentication

Configuration Effect

- Establish line-based login identity authentication.
- Run the **telnet** command on a network device to log in to a remote device.
- Close an established connection if no output is detected during the timeout time.
- Disconnect an established session connecting to a remote host and restore the host to Idle if no output is detected during the timeout time.
- Lock a terminal to deny access. When a user enters any character on the locked terminal, the password prompt is displayed. The terminal will be automatically unlocked if the entered password is correct.

Configuration Steps

▾ Configuring Local User Information

- Mandatory.
- Run the **username** command to configure the account used for local identity authentication and authorization, including usernames, passwords, and optional authorization information.
- Perform this configuration on every device.

▾ Configuring Local Authentication for Line-Based Login

- Mandatory.
- Configure local authentication for line-based login in the case that AAA is disabled.
- Perform this configuration on every device.

▾ **Configuring AAA Authentication for Line-Based Login**

- (Optional) Perform this configuration to configure AAA authentication for line-based login.
- Configure AAA authentication for line-based login in the case that AAA is enabled.
- Perform this configuration on every device.

▾ **Enabling the Telnet Client Service**

- Run the **telnet** command to log in to a remote device.

▾ **Restoring a Telnet Client Connection**

- (Optional) Perform this configuration to restore the connection on a Telnet client.

▾ **Closing a Suspended Telnet Client Connection**

- (Optional) Perform this configuration to close the suspended connection on a Telnet client.

▾ **Enabling the Telnet Server Service**

- Optional.
- Enable the Telnet Server service when you need to enable Telnet login.

▾ **Configuring the Connection Timeout Time**

- Optional.
- An established connection will be closed if no output is detected during the timeout time.
- Perform this configuration when you need to increase or reduce the connection timeout time.

▾ **Configuring the Session Timeout Time**

- Optional.
- The session connecting to a remote host will be disconnected and the host be restored to Idle if no output is detected during the timeout time.
- Perform this configuration when you need to increase or reduce the session timeout time.

▾ **Locking a Session**

- (Optional) Perform this configuration when you need to temporarily exit a session on a device.
- To lock a session, first enable terminal lock in line configuration mode, and then run the **lock** command to lock the terminal.

Verification

- Run the **show running-config** command to display the configuration.
- In the case that AAA is disabled, after local user information and line-based local authentication are configured, check whether users are prompted for username and password input for access to the CLI.
- In the case that AAA is enabled, after local user information and local AAA authentication are configured, check whether users are prompted for username and password input for access to the CLI.
- Run the **show user** command to display the information about the users who have logged in to the CLI.
- Telnet clients can connect to devices enabled with the Telnet Server service.
- When a user presses **Enter** on a locked CLI, the user is prompted for password input. The session is unlocked only when the entered password is the same as the configured one.
- Run the **show sessions** command to display every established Telnet client instance.

Related Commands

Configuring Local User Information

| | |
|------------------------------|---|
| Command | username <i>name</i> [login mode { console ssh telnet }] [online amount <i>number</i>] [permission <i>oper-mode path</i>] [privilege <i>privilege-level</i>] [reject remote-login] [web-auth] [pwd-modify] [nopassword password [0 7] <i>text-string</i>] |
| Parameter Description | <p><i>name</i>: Indicates a user name.</p> <p>login mode: Indicates the login mode.</p> <p>console: Sets the login mode to Console.</p> <p>ssh: Sets the login mode to SSH.</p> <p>telnet: Sets the login mode to Telnet.</p> <p>online amount <i>number</i>: Indicates the maximum number of online accounts.</p> <p>permission <i>oper-mode path</i>: Configures the file operation permission. <i>op-mode</i> indicates the operation mode, and <i>path</i> indicates the directory or path of a specific file.</p> <p>privilege <i>privilege-level</i>: Indicates the account privilege level, ranging from 0 to 15.</p> <p>reject remote-login: Rejects remote login by using the account.</p> <p>web-auth: Allows only Web authentication for the account.</p> <p>pwd-modify: Allows the account owner to change the password. This option is available only when web-auth is configured.</p> <p>nopassword: Indicates that no password is configured for the account.</p> <p>password [0 7] <i>text-string</i>: Indicates the password configured for the account. 0 indicates that the password is input in plaintext, and 7 indicates that the password is input in cyphertext. The default is plaintext.</p> |
| Command Mode | Global configuration mode |
| Usage Guide | <p>Use this command to create a local user database to be used by authentication.</p> <p>If the value 7 is selected for the encryption type, the entered cyphertext string must consist of an even number of characters.</p> |

| | |
|--|---|
| | This setting is applicable to the scenario where encrypted passwords may be copied and pasted. In other cases, the value 7 is not selected. |
|--|---|

▾ Configuring Local Authentication for Line-Based Login

| | |
|------------------------------|--|
| Command | login local |
| Parameter Description | N/A |
| Command Mode | Line configuration mode |
| Usage Guide | Use this command to configure local authentication for line-based login in the case that AAA is disabled. Local user information is configured by using the username command. |

▾ Configuring AAA Authentication for Line-Based Login

| | |
|------------------------------|--|
| Command | login authentication { default list-name } |
| Parameter Description | default: Indicates the default authentication method list name. <i>list-name:</i> Indicates the optional method list name. |
| Command Mode | Line configuration mode |
| Usage Guide | Use this command to configure AAA authentication for line-based login in the case that AAA is enabled. The AAA authentication methods, including RADIUS authentication, local authentication, and no authentication, are used during the authentication process. |

▾ Enabling the Telnet Client Service

| | |
|------------------------------|---|
| Command | telnet host [port] [/source { ip A.B.C.D ipv6 X:X:X:X::X interface interface-name }] |
| Parameter Description | <i>host:</i> Indicates the IPv4 address, IPv6 address, or host name of the Telnet server. <i>port:</i> Indicates the TCP port number of the Telnet server. The default value is 23. /source: Indicates the source IP address or source port used by a Telnet client. ip A.B.C.D: Indicates the source IPv4 address used by the Telnet client. ipv6 X:X:X:X::X: Indicates the source IPv6 address used by the Telnet client. interface interface-name: Indicates the source port used by the Telnet client. |
| Command Mode | Privileged EXEC mode |
| Usage Guide | A user can telnet to a remote device identified by an IPv4 host name, IPv6 host name, IPv4 address, or IPv6 address. |

▾ Restoring a Telnet Client Session

| | |
|------------------------------|--------|
| Command | <1-99> |
| Parameter Description | N/A |

| | |
|---------------------|--|
| Command Mode | User EXEC mode |
| Usage Guide | Use this command to restore a Telnet client session. A user can press the shortcut key Ctrl+Shift+6 X to temporarily exit the Telnet client session that is established using the telnet command, run the <1-99> command to restore the session, and run the show sessions command to display the session information. |

↘ Closing a Suspended Telnet Client Connection

| | |
|------------------------------|--|
| Command | disconnect <i>session-id</i> |
| Parameter Description | <i>session-id</i> : Indicates the suspended Telnet client session ID. |
| Command Mode | User EXEC mode |
| Usage Guide | Use this command to close a specific Telnet client session by entering the session ID. |

↘ Enabling the Telnet Server Service

| | |
|------------------------------|--|
| Command | enable service telnet-server |
| Parameter Description | N/A |
| Command Mode | Global configuration mode |
| Usage Guide | Use this command to enable the Telnet Server service. The IPv4 and IPv6 services are also enabled after the command is executed. |

↘ Configuring the Connection Timeout Time

| | |
|------------------------------|--|
| Command | exec-timeout <i>minutes</i> [<i>seconds</i>] |
| Parameter Description | <i>minutes</i> : Indicates the connection timeout time in the unit of minutes. <i>seconds</i> : Indicates the connection timeout time in the unit of seconds. |
| Command Mode | Line configuration mode |
| Usage Guide | Use this command to configure the timeout time for the established connections on a line. A connection will be closed when no input is detected during the timeout time. To remove the connection timeout configuration, run the no exec-timeout command in line configuration mode. |

↘ Configuring the Session Timeout Time

| | |
|------------------------------|---|
| Command | session-timeout <i>minutes</i> [output] |
| Parameter Description | <i>minutes</i> : Indicates the session timeout time in the unit of minutes. output : Indicates whether to add data output as a timeout criterion. |
| Command Mode | Line configuration mode |

| | |
|--------------------|---|
| Usage Guide | Use this command to configure the timeout time for the remote host sessions on a line. A session will be disconnected when no input is detected during the timeout time. To cancel the session timeout time, run the no session-timeout command in line configuration mode. |
|--------------------|---|

▾ Enabling Line-Based Terminal Lock

| | |
|---------------------|-------------------------|
| Command | lockable |
| Parameter | N/A |
| Description | |
| Command Mode | Line configuration mode |
| Usage Guide | N/A |

▾ Locking a Terminal Connected to the Current Line

| | |
|---------------------|-------------------------|
| Command | lock |
| Parameter | N/A |
| Description | |
| Command Mode | Line configuration mode |
| Usage Guide | N/A |

Configuration Example

▾ Establishing a Telnet Session to a Remote Network Device

| | |
|----------------------------|---|
| Configuration Steps | <ul style="list-style-type: none"> Establish a Telnet session to a remote network device with the IP address 192.168.65.119. Establish a Telnet session to a remote network device with the IPv6 address 2AAA:BBBB::CCCC. |
| | <pre>Ruijie# telnet 192.168.65.119 Trying 192.168.65.119 ... Open User Access Verification Password:</pre> |
| | <pre>Ruijie# telnet 2AAA:BBBB::CCCC Trying 2AAA:BBBB::CCCC ... Open User Access Verification Password:</pre> |
| Verification | <ul style="list-style-type: none"> Check whether the Telnet sessions are established to the remote network devices. |

▾ Configuring the Connection Timeout Time

| | |
|----------------------------|--|
| Configuration Steps | <ul style="list-style-type: none"> ● Set the connection timeout time to 20 minutes. |
| | <pre>Ruijie# configure terminal//Enter global configuration mode. Ruijie# line vty 0 //Enter line configuration mode. Ruijie(config-line)#exec-timeout 20 //Set the connection timeout time to 20 minutes.</pre> |
| Verification | <ul style="list-style-type: none"> ● Check whether the connection between a terminal and the local device is closed when no input is detected during the timeout time. |

▾ **Configuring the Session Timeout Time**

| | |
|----------------------------|---|
| Configuration Steps | <ul style="list-style-type: none"> ● Set the session timeout time to 20 minutes. |
| | <pre>Ruijie# configure terminal//Enter global configuration mode. Ruijie(config)# line vty 0 //Enter line configuration mode. Ruijie(config-line)#session-timeout 20//Set the session timeout time to 20 minutes.</pre> |
| Verification | <ul style="list-style-type: none"> ● Check whether the session between a terminal and the local device is disconnected when no input is detected during the timeout time. |

2.4.3 Configuring Basic System Parameters

Configuration Effect

- Configure basic system parameters.

Configuration Steps

▾ **Configuring the System Date and Clock**

- Mandatory.
- Configure the system time of a network device manually. The device clock starts from the configured time and keeps running even when the device is powered off.

 The time configuration is applied only to the software clock if the network device does not provide a hardware clock. The configuration will be invalid when the device is powered off.

▾ **Updating the Hardware Clock**

- Optional.
- Perform this configuration when you need to copy the date and time of the software clock to the hardware clock so that the hardware clock is synchronized with the software clock.

▾ Configuring a System Name

- (Optional) Perform this configuration to change the default system name.

▾ Configuring a Command Prompt

- (Optional) Perform this configuration to change the default command prompt.

▾ Configuring Daily Notification

- (Optional) Perform this configuration when you need to display important prompts or warnings to users.
- You can configure notification in one or multiple lines, which will be displayed to users after login.

▾ Configuring a Login Banner

- (Optional) Perform this configuration when you need to display important messages to users upon login or logout.

▾ Configuring the Console Baud Rate

- (Optional) Perform this configuration to change the default Console baud rate.

Verification

- Run the **show clock** command to display the system time.
- Check whether a login banner is displayed after login.
- Run the **show version** command to display the system information and version.

Related Commands

▾ Configuring the System Date and Clock

| | |
|------------------------------|---|
| Command | clock set <i>hh:mm:ss month day year</i> |
| Parameter Description | <i>hh:mm:ss</i> : Indicates the current time, in the format of <i>hour</i> (24-hour format): <i>minute:second</i> . <i>day</i> : Indicates a day (1–31) of the month. <i>month</i> : Indicates a month (from January to December) of the year. <i>year</i> : Indicates a year, ranging from 1993 to 2035. Abbreviation is not supported. |
| Command Mode | Privileged EXEC mode |
| Usage Guide | Use this command to configure the system time. If the device does not provide a hardware clock, the time configuration will be invalid when the device is powered off. |

▾ Updating the Hardware Clock

| | |
|------------------------------|------------------------------|
| Command | clock update-calendar |
| Parameter Description | N/A |

| | |
|---------------------|--|
| Command Mode | Privileged EXEC mode |
| Usage Guide | After the configuration, the time of the software clock will overwrite that of the hardware clock. |

↘ Configuring a System Name

| | |
|------------------------------|---|
| Command | hostname <i>name</i> |
| Parameter Description | <i>name</i> : Indicates the system name, which must consist of printable characters and must not exceed 63 bytes. |
| Command Mode | Global configuration mode |
| Usage Guide | To restore the system name to the default, run the no hostname command in global configuration mode. |

↘ Configuring a Command Prompt

| | |
|------------------------------|--|
| Command | prompt <i>string</i> |
| Parameter Description | <i>string</i> : Indicates the command prompt name. A name with more than 32 characters will be truncated to keep only the first 32 characters. |
| Command Mode | Privileged EXEC mode |
| Usage Guide | To restore the command prompt to the default settings, run the no prompt command in global configuration mode. |

↘ Configuring Daily Notification

| | |
|------------------------------|--|
| Command | banner motd <i>c message c</i> |
| Parameter Description | <i>c</i> : Indicates a delimiter, which can be any character, such as "&". |
| Command Mode | Global configuration mode |
| Usage Guide | A message must start and end with delimiter+carriage return respectively. Any characters following the ending delimiter will be dropped. Any letter contained in the message must not be used as the delimiter. The message must not exceed 255 bytes. |

↘ Configuring a Login Banner

| | |
|------------------------------|--|
| Command | banner login <i>c message c</i> |
| Parameter Description | <i>c</i> : Indicates a delimiter, which can be any character, such as "&". |
| Command Mode | Global configuration mode |
| Usage Guide | A message must start and end with delimiter+carriage return respectively. Any characters following the ending delimiter will be dropped. Any letter contained in the message must not be used as the delimiter. The message must not exceed 255 bytes. |

| | |
|--|--|
| | To remove the login banner configuration, run the no banner login command in global configuration mode. |
|--|--|

↘ Configuring the Console Baud Rate

| | |
|------------------------------|--|
| Command | speed <i>speed</i> |
| Parameter Description | <i>speed</i> : Indicates the console baud rate, in the unit of bps. The serial port baud rate can be set to 9,600 bps, 19,200 bps, 38,400 bps, 57,600 bps, or 115,200 bps. The default is 9,600 bps. |
| Command Mode | Line configuration mode |
| Usage Guide | You can configure the asynchronous line baud rate based on requirements. The speed command is used to configure receive and transmit rates for the asynchronous line. |

Configuration Example

↘ Configuring the System Time

| | |
|----------------------------|---|
| Configuration Steps | <ul style="list-style-type: none"> Change the system time to 2003-6-20, 10:10:12. |
| | <pre>Ruijie# clock set 10:10:12 6 20 2003 //Configure the system time and date.</pre> |
| Verification | <ul style="list-style-type: none"> Run the show clock command in privileged EXEC mode to display the system time. |
| | <pre>Ruijie# show clock //Confirm that the changed system time takes effect. clock: 2003-6-20 10:10:54</pre> |

↘ Configuring Daily Notification

| | |
|----------------------------|---|
| Configuration Steps | <ul style="list-style-type: none"> Configure the daily notification message "Notice: system will shutdown on July 6th." with the pound key (#) as the delimiter. |
| | <pre>Ruijie(config)# banner motd #//Starting delimiter Enter TEXT message. End with the character '#'. Notice: system will shutdown on July 6th.# //Ending delimiter Ruijie(config)#</pre> |
| Verification | <ul style="list-style-type: none"> Run the show running-config command to display the configuration. Connect to the local device through the Console, Telnet or SSH, and check whether daily notification is displayed before the CLI appears. |
| | <pre>C:\>telnet 192.168.65.236 Notice: system will shutdown on July 6th. Access for authorized users only. Please enter your password.</pre> |

| | |
|----------------------------|---|
| Configuration Steps | <ul style="list-style-type: none"> Configure the daily notification message "Notice: system will shutdown on July 6th." with the pound key (#) as the delimiter. |
| | <pre>Ruijie(config)# banner motd #//Starting delimiter Enter TEXT message. End with the character '#'. Notice: system will shutdown on July 6th.# //Ending delimiter Ruijie(config)#</pre> |
| Verification | <ul style="list-style-type: none"> Run the show running-config command to display the configuration. Connect to the local device through the Console, Telnet or SSH, and check whether daily notification is displayed before the CLI appears. |
| | <pre>User Access Verification Password:</pre> |

➤ **Configuring a Login Banner**

| | |
|----------------------------|---|
| Configuration Steps | <ul style="list-style-type: none"> Configure the login banner message "Access for authorized users only. Please enter your password." with the pound key (#) as the delimiter. |
| | <pre>Ruijie(config)# banner login #//Starting delimiter Enter TEXT message. End with the character '#'. Access for authorized users only. Please enter your password. # //Ending delimiter Ruijie(config)#</pre> |
| Verification | <ul style="list-style-type: none"> Run the show running-config command to display the configuration. Connect to the local device through the Console, Telnet or SSH, and check whether the login banner is displayed before the CLI appears. |
| | <pre>C:\>telnet 192.168.65.236 Notice: system will shutdown on July 6th. Access for authorized users only. Please enter your password. User Access Verification Password:</pre> |

➤ **Configuring the Serial Port Baud Rate**

| | |
|----------------------------|---|
| Configuration Steps | <ul style="list-style-type: none"> ● Set the serial port baud rate to 57,600 bps. |
| | <pre>Ruijie# configure terminal //Enter global configuration mode. Ruijie(config)# line console 0 //Enter console line configuration mode. Ruijie(config-line)# speed 57600 //Set the console baud rate to 57,600 bps. Ruijie(config-line)# end //Returns to privileged mode.</pre> |
| Verification | <ul style="list-style-type: none"> ● Run the show command to display the configuration. |
| | <pre>Ruijie# show line console 0 //Displays the console configuration. CON Type speed Overruns * 0 CON 57600 0 Line 0, Location: "", Type: "vt100" Length: 25 lines, Width: 80 columns Special Chars: Escape Disconnect Activation ^x none ^M Timeouts: Idle EXEC Idle Session never never History is enabled, history size is 10. Total input: 22 bytes Total output: 115 bytes Data overflow: 0 bytes stop rx interrupt: 0 times Modem: READY</pre> |

2.4.4 Enabling and Disabling a Specific Service

Configuration Effect

- Dynamically adjust system services when the system is running, and enable and disable specific services (SNMP Agent, SSH Server, and Telnet Server).

Configuration Steps

▾ Enabling the SNMP Agent, SSH Server, and Telnet Server Services

- (Optional) Perform this configuration when you need to use these services.

Verification

- Run the **show running-config** command to display the configuration.
- Run the **show services** command to display the service Enabled/Disable state.

Related Commands

▾ Enabling the SSH Server, Telnet Server, and SNMP Agent Services

| | |
|------------------------------|---|
| Command | enable service { ssh-server telnet-server snmp-agent } |
| Parameter Description | <p>ssh-server: Enables or disables the SSH Server service. The IPv4 and IPv6 services are also enabled together with this service.</p> <p>telnet-server: Enables or disables the Telnet Server service. The IPv4 and IPv6 services are also enabled together with this service.</p> <p>snmp-agent: Enables or disables the SNMP Agent service. The IPv4 and IPv6 services are also enabled together with this service.</p> |
| Command Mode | Global configuration mode |
| Usage Guide | Use this command to enable and disable specific services. |

Configuration Example

▾ Enabling the SSH Server Service

| | |
|----------------------------|--|
| Configuration Steps | <ul style="list-style-type: none"> ● Enable the SSH Server service. <pre>Ruijie# configure terminal //Enter global configuration mode. Ruijie(config)#enable service ssh-server //Enable the SSH Server service.</pre> |
| Verification | <ul style="list-style-type: none"> ● Run the show running-config command to display the configuration. ● Run the show ip ssh command to display the configuration and running state of the SSH Server service. |

2.4.5 Configuring a Restart Policy

Configuration Effect

Configure a restart policy to restart a device as scheduled.

Configuration Steps

▾ Configuring Direct Restart

Run the **reload** command in privileged EXEC mode to restart the system immediately.

↘ Configuring Timed Restart

```
reload at hh:mm:ss month day year
```

If you configure a specific time, the system will restart at the time. The time must be a time in the future. The **month day year** parameter is optional. If it is not specified, the system clock time is used by default.

 The clock feature must be supported by the system if you want to use the **at** option. It is recommended that you configure the system clock in advance. A new restart plan will overwrite the existing one. A restart plan will be invalid if the system is restarted before the plan takes effect.

 The restart time must be later than the current system time. After you configure a restart plan, do not change the system clock; otherwise, the plan may fail (for example, the system time is changed to a time after the restart time.)

Related Commands

↘ Restarting a Device

| | |
|------------------------------|---|
| Command | <code>reload [at { hh [:mm [:ss]] } [month [day [year]]]]</code> |
| Parameter Description | <p>at <i>hh:mm:ss</i>: Indicates the time when the system will restart.</p> <p><i>month</i>: Indicates a month of the year, ranging from 1 to 12.</p> <p><i>day</i>: Indicates a date, ranging from 1 to 31.</p> <p><i>year</i>: Indicates a year, ranging from 1993 to 2035. Abbreviation is not supported.</p> |
| Command Mode | Privileged EXEC mode |
| Usage Guide | Use this command to enable a device to restart at a specific time. |

2.5 Monitoring

Displaying

| Description | Command |
|--|--|
| show clock | Displays the current system time. |
| show line { console <i>line-num</i> vty <i>line-num</i> <i>line-num</i> } | Displays line configurations. |
| show reload | Displays system restart settings. |
| show running-config [interface <i>interface</i>] | Displays the current running configurations of the device or the configurations on an interface. |
| show startup-config | Displays the device configurations stored in the NVRAM. |
| show this | Displays the current system configurations. |
| show sessions | Displays the information of each established Telnet client instance. |

3 Configuring Lines

3.1 Overview

There are various types of terminal lines on network devices. You can manage terminal lines in groups based on their types. Configurations on these terminal lines are called line configurations. On network devices, terminal lines are classified into multiple types such as CTY and VTY.

3.2 Applications

| Application | Description |
|--|---|
| Accessing a Device Through Console | Enter the command-line interface (CLI) of a network device through the Console. |
| Accessing a Device Through VTY | Enter the CLI of a network device through Telnet or SSH. |

3.2.1 Accessing a Device Through Console

Scenario

Figure 3-1



| | |
|----------------|---|
| Remarks | A is a network device to be managed. PC is a network management station. |
|----------------|---|

Deployment

The network management station connects to the Console port of a network device through a serial cable. Using the Console software (Hyper Terminal or other terminal simulation software) on the network management station, you can access the Console of the network device and enter the CLI to configure and manage the network device.

3.2.2 Accessing a Device Through VTY

Scenario

Figure 3-2



| | |
|----------------|---|
| Remarks | A is a network device to be managed. PC is a network management station. |
|----------------|---|

Deployment

The network management station connects to a network device through the network. Using a VTY client (such as Putty) on the network management station, you can access the network device through Telnet or SSH and enter the CLI to configure and manage the network device.

3.3 Features

Basic Concepts

↳ CTY

The CTY line refers to the line connected to the Console port. Most network devices have a Console port. You can access the local system through the Console port.

↳ VTY

The VTY line is a virtual terminal line that does not correspond to any hardware. It is used for Telnet or SSH connection.

Overview

| Feature | Description |
|--------------------------------|---|
| Basic Features | Configures a terminal, displays and clears terminal connection information. |

3.3.1 Basic Features

Related Configuration

↳ Clearing Terminal Connections

When a terminal connects to the network device, the corresponding terminal line is occupied. Run the **show user** command to display the connection status of these terminal lines. If you want to disconnect the terminal from the network device, run the **clear line** command to clear the terminal line. After the terminal lines are cleared, the related connections (such as Telnet and SSH) are interrupted, the CLI exits, and the terminal lines restore to the unoccupied status. Users can re-establish connections.

↳ Specifying the Number of VTY Terminals

Run the **line vty** command to enter the VTY line configuration mode and specify the number of VTY terminals.

By default, there are 5 VTY terminals, numbered from 0 to 4. You can increase the number of VTY terminals to 36, with new ones numbered from 5 to 35. Only new terminals can be removed.

3.4 Configuration

| Configuration | Description and Command | | |
|--|--|---|--|
| Entering Line Configuration Mode |  (Mandatory) It is used to enter the line configuration mode. | | |
| | line [console tty vty] <i>first-line</i> [<i>last-line</i>] | Enters the specified line configuration mode. | |
| | line vty <i>line-number</i> | Increases or reduces the number of available VTY lines. | |

3.4.1 Entering Line Configuration Mode

Configuration Effect

Enter line configuration mode to configure other functions.

Configuration Steps

↘ Entering Line Configuration Mode

- Mandatory.
- Unless otherwise specified, enter line configuration mode on each device to configure line attributes.

↘ Increasing/Reducing the Number of VTY Lines

- Optional.
- Run the **(no) line vty** *line-number* command to increase or reduce the number of VTY lines.

Verification

Run the **show line** command to display line configuration.

Related Commands

↘ Entering Line Configuration Mode

| | |
|--------------------|---|
| Command | line [console vty] <i>first-line</i> [<i>last-line</i>] |
| Parameter | console : Indicates the Console port. |
| Description | vty : Indicates a virtual terminal line, which supports Telnet or SSH. <i>first-line</i> : Indicates the number of the first line. <i>last-line</i> : Indicates the number of the last line. |

| | |
|---------------------|---------------------------|
| Command Mode | Global configuration mode |
| Usage Guide | N/A |

↘ **Increasing/Reducing the Number of VTY Lines**

| | |
|------------------------------|--|
| Command | line vty <i>line-number</i> |
| Parameter Description | <i>line-number</i> : Indicates the number of VTY lines. The value ranges from 0 to 35. |
| Command Mode | Global configuration mode |
| Usage Guide | Run the no line vty <i>line-number</i> command to reduce the number of available VTY lines. |

↘ **Displaying Line Configuration**

| | |
|------------------------------|---|
| Command | show line { console <i>line-num</i> vtty <i>line-num</i> <i>line-num</i> } |
| Parameter Description | console : Indicates the Console port. vtty : Indicates a virtual terminal line, which supports Telnet or SSH. <i>line-num</i> : Indicates the line to be displayed. |
| Command Mode | Privileged EXEC mode |
| Usage Guide | N/A |

Configuration Example

| Scenario Figure 3-3 |  <p>The diagram shows a PC on the left connected by a line to a network device labeled 'A' on the right. The PC is represented by a laptop icon, and 'A' is represented by a server rack icon.</p> | | | | | | | | | | |
|-------------------------------|--|---------|----------|----------|------|----------|-----------|-----|------|----------|-----|
| Configuration Steps | <ul style="list-style-type: none"> ● Connect the PC to network device A through the Console line and enter the CLI on the PC. ● Run the show user command to display the connection status of the terminal line. ● Run the show line console 0 command to display the status of the Console line. ● Enter global configuration mode and run the line vty command to increase the number of VTY terminals to 36. | | | | | | | | | | |
| A | <pre>Ruijie#show user</pre> <table border="1"> <thead> <tr> <th>Line</th> <th>User</th> <th>Host(s)</th> <th>Idle</th> <th>Location</th> </tr> </thead> <tbody> <tr> <td>* 0 con 0</td> <td>---</td> <td>idle</td> <td>00:00:00</td> <td>---</td> </tr> </tbody> </table> | Line | User | Host(s) | Idle | Location | * 0 con 0 | --- | idle | 00:00:00 | --- |
| Line | User | Host(s) | Idle | Location | | | | | | | |
| * 0 con 0 | --- | idle | 00:00:00 | --- | | | | | | | |

| | |
|----------------------------|---|
| | <pre> Ruijie#show line console 0 CON Type speed Overruns * 0 CON 9600 0 Line 0, Location: "", Type: "vt100" Length: 24 lines, Width: 79 columns Special Chars: Escape Disconnect Activation ^x ^D ^M Timeouts: Idle EXEC Idle Session 00:10:00 never History is enabled, history size is 10. Total input: 490 bytes Total output: 59366 bytes Data overflow: 0 bytes stop rx interrupt: 0 times Ruijie#show line vty ? <0-5> Line number Ruijie#configure terminal Enter configuration commands, one per line. End with CNTL/Z. Ruijie(config)#line vty 35 Ruijie(config-line)# *Oct 31 18:56:43: %SYS-5-CONFIG_I: Configured from console by console </pre> |
| <p>Verification</p> | <ul style="list-style-type: none"> ● After running the show line command, you can find that the number of terminals increases. ● Run the show running-config command to display the configuration. |
| <p>A</p> | <pre> Ruijie#show line vty ? <0-35> Line number Ruijie#show running-config </pre> |

```
Building configuration...

Current configuration : 761 bytes

version 11.0(1C2B1) (10/16/13 04:23:54 CST -ngcf78)
ip tcp not-send-rst
vlan 1
!
interface GigabitEthernet 0/0
!
interface GigabitEthernet 0/1
 ip address 192.168.23.164 255.255.255.0
!
interface GigabitEthernet 0/2
!
interface GigabitEthernet 0/3
!
interface GigabitEthernet 0/4
!
interface GigabitEthernet 0/5
!
interface GigabitEthernet 0/6
!
interface GigabitEthernet 0/7
!
interface Mgmt 0
!
line con 0
line vty 0 35
 login
!
```

| | |
|--|-----|
| | end |
|--|-----|

3.5 Monitoring

Clearing

 Running the **clear** commands may lose vital information and thus interrupt services.

| Description | Command |
|------------------------------------|---|
| Clears the line connection status. | clear line { aux <i>line-num</i> console <i>line-num</i> tty <i>line-num</i> vty <i>line-num</i> <i>line-num</i> } |

Displaying

| Description | Command |
|---|--|
| Displays the line configuration. | show line { aux <i>line-num</i> console <i>line-num</i> tty <i>line-num</i> vty <i>line-num</i> <i>line-num</i> } |
| Displays historical records of a line. | show history |
| Displays the privilege level of a line. | show privilege |
| Displays users on a line. | show user [all] |

4 Configuring RMON

4.1 Overview

The Remote Network Monitoring (RMON) aims at resolving problems of managing local area networks (LANs) and remote sites by using one central point. In RMON, network monitoring data consists of a group of statistics and performance indicators, which can be used for monitoring the network utilization, so as to facilitate network planning, performance optimization, and network error diagnosis.

RMON is mainly used by a managing device to remotely monitor and manage managed devices.

Protocols and Standards

STD 0059 / RFC 2819: Remote Network Monitoring Management Information Base

RFC4502: Remote Network Monitoring Management Information Base Version 2

RFC 3919: Remote Network Monitoring (RMON) Protocol Identifiers for IPv6 and Multi Protocol Label Switching (MPLS)

RFC 3737: IANA Guidelines for the Registry of Remote Monitoring (RMON) MIB Modules

RFC 3434: Remote Monitoring MIB Extensions for High Capacity Alarms

RFC 3395: Remote Network Monitoring MIB Protocol Identifier Reference Extensions

RFC 3287: Remote Monitoring MIB Extensions for Differentiated Services

RFC 3273: Remote Network Monitoring Management Information Base for High Capacity Networks

RFC 2896: Remote Network Monitoring MIB Protocol Identifier Macros

RFC 2895: Remote Network Monitoring MIB Protocol Identifier Reference

4.2 Applications

| Application | Description |
|---|---|
| Collecting Statistics on Information of a Monitored Interface | Applies four functions of RMON to an interface to monitor the network communication of the interface. |

4.2.1 Collecting Statistics on Information of a Monitored Interface

Scenario

The RMON Ethernet statistics function is used to monitor accumulated information of an interface, the history statistics function is used to monitor the packet count of an interface within each monitoring interval, and the alarm function is used to immediately acquire packet count exceptions of an interface. The following figure shows the networking topology.

Figure 4-1

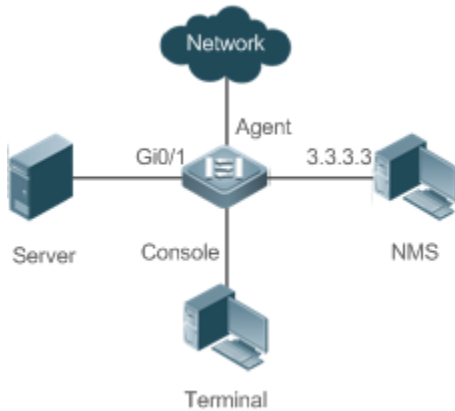

Deployment

Interface is monitored to accumulatively collect statistics on the packet count of the interface and collect statistics on the packet count and bandwidth utilization of the interface within the monitoring interval. If a packet count exception occurs on the interface, an alarm is reported to the network management system (NMS). The configuration key points are as follows:

- Configure the RMON Ethernet statistics function on interface.
- Configure the RMON history statistics function on interface.
- Configure the RMON alarm table and define RMON event processing actions in configuration mode. Monitored objects of alarms are the object identifier (OID) values of specific fields in the RMON Ethernet statistical table configured for interface.

4.3 Features

Basic Concepts

RMON defines multiple RMON groups. Ruijie products support the statistics group, history group, alarm group, and event group, which are described as follows:

Statistics Group

The statistics group is used to monitor and collect statistics on Ethernet interface traffic information, which is accumulated from the entry creation time to the current time. The statistical items include discarded data packets, broadcast data packets, cyclic redundancy check (CRC) errors, large and small blocks, and collisions. Statistical results are stored in the Ethernet statistical table.

History Group

The history group is used to periodically collect network traffic information. It records accumulated values of network traffic information and the bandwidth utilization within each interval, and saves them in the history control table. It includes two small groups:

- The HistoryControl group is used to set the sampling interval, sampling data source, and other control information.

- The EthernetHistory group provides administrators with historical data, including statistics on network segment traffic, error packets, broadcast packets, utilization, and number of collisions.

Alarm Group

The alarm group is used to monitor a specified Management Information Base (MIB) object. When the value of a MIB object exceeds the preset upper limit or is lower than the preset lower limit, an alarm is triggered and the alarm is processed as an event.

Event Group

The event group is used to define the event processing mode. When a monitored MIB object meets alarm conditions, an event is triggered. An event can be processed in any of the following modes:

- none: No action is taken.
- log: Event-relevant information is recorded in the log record table so that administrators can view it at any time.
- snmp-trap: A trap message is transmitted to the NMS to notify the NMS of the event occurrence.
- log-and-trap: Event-relevant information is recorded in the log record table and a trap message is transmitted to the NMS.

Working Principle

RMON supports multiple monitors and two data collection methods. Method 1: A dedicated RMON probe is used to collect data and the NMS can directly acquire all information about the RMON MIB from the RMON probe. Method 2: RMON agents are built into network devices (such as switches and routers) so that the devices have the RMON probe function. The NMS uses basic commands of the Simple Network Management Protocol (SNMP) to exchange data with the RMON agents and collect network management information. This method, however, is limited by device resources and information of only four groups rather than all data of the RMON MIB is acquired.

The following figure shows an example of communication between the NMS and RMON agents. The NMS, through the RMON agents running on devices, can acquire information about overall traffic, error statistics, and performance statistics of the network segment where a managed network device interface is, thereby implementing remote management of network devices.

Figure 4-2



Overview

| Feature | Description |
|--|---|
| RMON Ethernet Statistics | Collects statistics on the packet count, byte count, and other data of a monitored Ethernet interface accumulatively. |
| RMON History Statistics | Records the counts of packets, bytes, and other data communicated by an Ethernet interface within the configured interval and calculates the bandwidth utilization within the interval. |
| RMON Alarm | Samples values of monitored variables at intervals. The alarm table is used in combination with the event table. When the upper or lower limit is reached, a relevant event table is triggered to perform event processing or no processing is performed. |

4.3.1 RMON Ethernet Statistics

Working Principle

The RMON Ethernet statistics function accumulatively collects statistics on network traffic information of an Ethernet interface from the entry creation time to the current time.

Related Configuration

↘ [Configuring RMON Statistical Entries](#)

- The RMON Ethernet statistics function is disabled by default.
- Run the **rmon collection stats** command to create Ethernet statistical entries on a specified Ethernet interface.
- After statistical entries are successfully created on a specified interface, the statistics group collects statistics on the traffic information of the current interface. The statistical items are variables defined in the RMON Ethernet statistical table, and recorded information is the accumulated values of variables from the creation time of the RMON statistical table to the current time.

4.3.2 RMON History Statistics

Working Principle

The RMON history statistics function records accumulated statistics on traffic information of an Ethernet interface within each interval.

Related Configuration

↘ [Configuring RMON Historical Control Entries](#)

- The RMON history statistics function is disabled by default.
- Run the **rmon collection history** command to create historical control entries on an Ethernet interface.
- The RMON history group collects statistics on variables defined in the RMON history table and records accumulated values of variables within each interval.

4.3.3 RMON Alarm

Working Principle

The RMON alarm function periodically monitors value changes of alarm variables. If the value of an alarm variable reaches the specified upper threshold or lower threshold, a corresponding event is triggered for processing, for example, a trap message is transmitted or one logTable entry record is generated. If a lower threshold or upper threshold is reached multiple times consecutively, only one corresponding event is triggered and another event is triggered till a reverse threshold is reached.

Related Configuration



▾ Configuring the Event Table

- The RMON event group function is disabled by default.
- Run the **rmon event** command to configure the event table.

▾ Configuring Alarm Entries

- The RMON alarm group function is disabled by default.
- Run the **rmon event** command to configure the event table and run the **rmon alarm** command to configure the RMON alarm table.
- The RMON alarm function is implemented by the alarm table and event table jointly. If a trap message needs to be transmitted to a managing device in the case of an alarm event, the SNMP agent must be correctly configured first. For the configuration of the SNMP agent, see the *Configuring SNMP*.
- If a configured alarm object is a field node in the RMON statistics group or history group, the RMON Ethernet statistics function or RMON history statistics function need to be configured on a monitored Ethernet interface first.

4.4 Configuration

| Configuration | Description and Command | |
|--|--|--|
| Configuring RMON Ethernet Statistics |  (Mandatory) It is used to accumulatively collect statistics on traffic information of an Ethernet interface. | |
| | rmon collection stats | Configures Ethernet statistical entries. |
| Configuring RMON History Statistics |  (Mandatory) It is used to collect, at intervals, statistics on traffic information of an Ethernet interface and the bandwidth utilization within the interval. | |
| | rmon collection history | Configures historical control entries. |
| Configuring RMON Alarm |  (Mandatory) It is used to monitor whether data changes of a variable is within the valid range. | |
| | rmon event | Configures event entries. |

| Configuration | Description and Command | |
|---------------|-------------------------|---------------------------|
| | rmon alarm | Configures alarm entries. |

4.4.1 Configuring RMON Ethernet Statistics

Configuration Effect

Acquire accumulated statistics on traffic information of a monitored Ethernet interface from the entry creation time to the current time.

Notes

This function cannot be configured in batch interface configuration mode.

Configuration Steps

↘ Configuring RMON Statistical Entries

- Mandatory.
- If statistics and monitoring are required for a specified interface, Ethernet statistical entries must be configured on this interface.

Verification

Run the **show rmon stats** command to display Ethernet statistics.

Related Commands

↘ Configuring RMON Statistical Entries

| | |
|------------------------------|---|
| Command | rmon collection stats <i>index</i> [owner <i>ownername</i>] |
| Parameter Description | <i>index</i> : Indicates the index number of a statistical entry, with the value ranging from 1 to 65535 . owner <i>ownername</i> : Indicates the entry creator, that is, <i>ownername</i> , which is a case-sensitive string of 1-63 characters. |
| Command Mode | Interface configuration mode |
| Usage Guide | The values of statistical entry parameters cannot be changed. |

Configuration Example

↘ Configuring RMON Ethernet Statistics

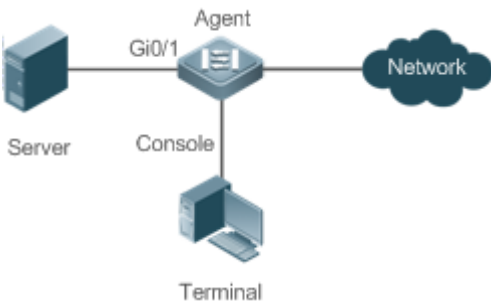
| | |
|--|--|
| <p>Scenario Figure 4-3</p> |  |
| | <p>As shown in the preceding figure, the RMON agent is connected to the server, and the NMS requires the RMON statistics group to conduct performance statistics on received packets of interface Gi0/1. Administrators can view the statistics at any time to understand data about received packets of an interface and take measures in a timely manner to handle network exceptions.</p> |
| <p>Configuration Steps</p> | <ul style="list-style-type: none"> Configure a statistical table instance on interface GigabitEthernet 0/1 to collect statistics on the traffic of this interface. |
| <p>Agent</p> | <pre>Ruijie# configure terminal Ruijie (config)# interface gigabitEthernet 0/1 Ruijie (config-if-GigabitEthernet 0/1)# rmon collection stats 1 owner admin</pre> |
| <p>Verification</p> | <p>Run the show rmon stats command to display Ethernet statistics.</p> |
| <p>Agent</p> | <pre>Ruijie# show rmon stats ether statistic table: index = 1 interface = GigabitEthernet 0/1 owner = admin status = 1 dropEvents = 0 octets = 25696 pkts = 293 broadcastPkts = 3 multiPkts = 0 crcAlignErrors = 0 underSizePkts = 0 overSizePkts = 0 fragments = 0</pre> |

```

jabbers = 0

collisions = 0

packets64Octets = 3815

packets65To127Octets = 1695

packets128To255Octets = 365

packets256To511Octets = 2542

packets512To1023Octets = 152

packets1024To1518Octets = 685
    
```

Common Errors

Statistical table entries are re-configured or configured statistical table entries are modified.

4.4.2 Configuring RMON History Statistics

Configuration Effect

Acquire accumulated statistics on the traffic of a monitored Ethernet interface and the bandwidth utilization within each interval.

Notes

This function cannot be configured in batch interface configuration mode.

Configuration Steps

- Mandatory.
- If network statistics on a specified interface need to be collected, RMON historical control entries must be configured on the interface.

Verification

Run the **show rmon history** command to display history group statistics.

Related Commands

↘ Configuring RMON Historical Control Entries

| | |
|--------------------|--|
| Command | rmon collection history <i>index</i> [owner <i>ownername</i>] [buckets <i>bucket-number</i>] [interval <i>seconds</i>] |
| Parameter | <i>index</i> : Indicates the index number of a history statistical entry, with the value ranging from 1 to 65535 . |
| Description | owner <i>ownername</i> : Indicates the entry creator, that is, <i>ownername</i> , which is a case-sensitive string of 1-63 characters. |

| | |
|---------------------|---|
| | <p>buckets <i>bucket-number</i>: Sets the capacity of the history table in which a history statistical entry exists, that is, sets the maximum number of records (<i>bucket-number</i>) that can be accommodated in the history table. The value of <i>bucket-number</i> ranges from 1 to 65535 and the default value is 10.</p> <p>interval <i>seconds</i>: Sets the statistical interval, with the unit of seconds. The value ranges from 1 second to 3600 seconds and the default value is 1800 seconds.</p> |
| Command Mode | Interface configuration mode |
| Usage Guide | The values of history statistical entry parameters cannot be changed. |

Configuration Example

Configuring RMON History Statistics

| | |
|---------------------------------------|--|
| <p>Scenario Figure 4-4</p> | |
| | <p>As shown in the preceding figure, the RMON agent is connected to the server, and the NMS needs to collect statistics on received packets of interface Gi0/1 through the RMON history group at an interval of 60 seconds, in an effort to monitor the network and understand emergency data.</p> |
| Configuration Steps | <ul style="list-style-type: none"> Configure the history control table on interface GigabitEthernet 0/1 to periodically collect statistics on the traffic of this interface. |
| Agent | <pre>Ruijie# configure terminal Ruijie(config)# interface gigabitEthernet 0/1 Ruijie(config-if-GigabitEthernet 0/1)# rmon collection history 1 buckets 5 interval 300 owner admin</pre> |
| Verification | <p>Run the show rmon history command to display history group statistics.</p> |
| Agent | <pre>Ruijie# show rmon history rmon history control table: index = 1 interface = GigabitEthernet 0/1 bucketsRequested = 5 bucketsGranted = 5</pre> |

```
interval = 60
owner = admin
stats = 1

rmon history table:

index = 1
sampleIndex = 786
intervalStart = 6d:18h:37m:38s
dropEvents = 0
octets = 2040
pkts = 13
broadcastPkts = 0
multiPkts = 0
crcAlignErrors = 0
underSizePkts = 0
overSizePkts = 0
fragments = 0
jabbers = 0
collisions = 0
utilization = 0

index = 1
sampleIndex = 787
intervalStart = 6d:18h:38m:38s
dropEvents = 0
octets = 1791
pkts = 16
broadcastPkts = 1
multiPkts = 0
crcAlignErrors = 0
underSizePkts = 0
```

```
overSizePkts = 0
fragments = 0
jabbers = 0
collisions = 0
utilization = 0

index = 1
sampleIndex = 788
intervalStart = 6d:18h:39m:38s
dropEvents = 0
octets = 432
pkts = 6
broadcastPkts = 0
multiPkts = 0
crcAlignErrors = 0
underSizePkts = 0
overSizePkts = 0
fragments = 0
jabbers = 0
collisions = 0
utilization = 0

index = 1
sampleIndex = 789
intervalStart = 6d:18h:40m:38s
dropEvents = 0
octets = 432
pkts = 6
broadcastPkts = 0
multiPkts = 0
crcAlignErrors = 0
```

```
underSizePkts = 0
overSizePkts = 0
fragments = 0
jabbers = 0
collisions = 0
utilization = 0

index = 1
sampleIndex = 790
intervalStart = 6d:18h:41m:38s
dropEvents = 0
octets = 86734
pkts = 934
broadcastPkts = 32
multiPkts = 23
crcAlignErrors = 0
underSizePkts = 0
overSizePkts = 0
fragments = 0
jabbers = 0
collisions = 0
utilization = 0
```

Common Errors

History control table entries are re-configured or configured history control table entries are modified.

4.4.3 Configuring RMON Alarm

Configuration Effect

Periodically monitor whether value changes of alarm variables are within the specified valid range.

Notes

If a trap message needs to be transmitted to a managing device when an alarm event is triggered, the SNMP agent must be correctly configured. For the configuration of the SNMP agent, see the *Configuring SNMP*.

If an alarm variable is a MIB variable defined in the RMON statistics group or history group, the RMON Ethernet statistics function or RMON history statistics function must be configured on the monitored Ethernet interface. Otherwise, an alarm table fails to be created.

Configuration Steps

Configuring Event Entries

- Mandatory.
- Complete the configuration in global configuration mode.

Configuring Alarm Entries

- Mandatory.
- Complete the configuration in global configuration mode.

Verification

- Run the **show rmon event** command to display the event table.
- Run the **show rmon alarm** command to display the alarm table.

Related Commands

Configuring the Event Table

| | |
|------------------------------|--|
| Command | rmon event <i>number</i> [log] [trap <i>community</i>] [description <i>description-string</i>] [owner <i>ownername</i>] |
| Parameter Description | <p><i>number</i>: Indicates the index number of an event table, with the value ranging from 1 to 65535.</p> <p>log: Indicates a log event. The system logs a triggered event.</p> <p>trap <i>community</i>: Indicates a trap event. When an event is triggered, the system transmits a trap message with the community name of <i>community</i>.</p> <p>description <i>description-string</i>: Sets the description information about an event, that is, <i>description-string</i>. The value is a string of 1-127 characters.</p> <p>owner <i>ownername</i>: Indicates the entry creator, that is, <i>ownername</i>, which is a case-sensitive string of 1-63 characters.</p> |
| Command Mode | Global configuration mode |
| Usage Guide | The values of configured event entry parameters can be changed, including the event type, trap community name, event description, and event creator. |

Configuring the RMON Alarm Group

| | |
|------------------------------|---|
| Command | rmon alarm <i>number</i> <i>variable</i> <i>interval</i> { absolute delta } rising-threshold <i>value</i> [<i>event-number</i>] falling-threshold <i>value</i> [<i>event-number</i>] [owner <i>ownername</i>] |
| Parameter Description | <i>number</i> : Indicates the index number of an alarm entry, with the value ranging from 1 to 65535. |

| | |
|---------------------|---|
| | <p><i>variable</i>: Indicates an alarm variable, which is a string of 1-255 characters and is represented in dotted format using the node OID (format: entry.integer.instance; example: 1.3.6.1.2.1.2.1.10.1).</p> <p><i>Interval</i>: Indicates the sampling interval, with the unit of seconds and the value ranging from 1 to 2147483647.</p> <p>absolute: Indicates that the sampling type is absolute value sampling, that is, variable values are directly extracted when the sampling time is up.</p> <p>delta: Indicates that the sampling type is changing value sampling, that is, changes in the variable values within the sampling interval are extracted when the sampling time is up.</p> <p>rising-threshold value: Sets the upper limit of the sampling quantity (<i>value</i>), with the value ranging from -2147483648 to +2147483647.</p> <p><i>event-number</i>: Indicates that an event with the event number of <i>event-number</i> is triggered when the upper limit or lower limit is reached.</p> <p>falling-threshold value: Sets the lower limit of the sampling quantity (<i>value</i>), with the value ranging from -2147483648 to +2147483647.</p> <p>owner ownername: Indicates the entry creator, that is, <i>ownername</i>, which is a case-sensitive string of 1-63 characters.</p> |
| Command Mode | Global configuration mode |
| Usage Guide | Values of configured alarm entry parameters can be changed, including alarm variables, sampling type, entry creator, sampling interval, upper/lower limit of the sampling quantity, and relevant trigger events. |

Configuration Example

Configuring RMON Alarm

| | |
|---------------------------------------|--|
| <p>Scenario Figure 4-5</p> | <p>The diagram shows a central switch icon. To its left is a 'Server' icon connected by a line labeled 'Gi0/1'. To its right is an 'NMS' icon connected by a line labeled '3.3.3.3'. Below the switch is a 'Terminal' icon connected by a line labeled 'Console'. Above the switch is a cloud icon labeled 'Network' connected by a line labeled 'Agent'.</p> |
| | <p>Assume that SNMPv1 runs on the NMS, the community name used for accessing the settings is public, with the attribute of read-write, and the IP address used by the NMS to receive trap messages is 3.3.3.3. Assume that the OID value of unknown protocol packets received by monitored interface GigabitEthernet0/3 is 1.3.6.1.2.1.2.2.1.15.3, the sampling mode is relative sampling, and the sampling interval is 60 seconds. When the relative sampling value is larger than 100 or lower than 10, event 1 and event 2 are triggered respectively. In event 1, a trap message is transmitted and the event is logged. In event 2, the event is only logged.</p> |

| | |
|-----------------------------------|---|
| | <p>The configuration of the RMON agent is completed on the terminal. The RMON agent is connected to the NMS and is connected to the server through interface GI0/1. The RMON agent needs to monitor the count of unknown protocol packets received by interface GI0/1. The sampling interval is 60 seconds. When the absolute sampling value is smaller than 10, the event is only logged. When the absolute sampling value is larger than 100, the event is logged and a trap message is transmitted to the NMS.</p> |
| <p>Configuration Steps</p> | <ul style="list-style-type: none"> ● Configure the host address for receiving trap messages. ● Configure an event group to process alarm trigger. ● Configure the alarm function. |
| <p>Agent</p> | <pre>Ruijie# configure terminal Enter configuration commands, one per line. End with CNTL/Z. Ruijie(config)# snmp-server community public rw Ruijie(config)# snmp-server host 3.3.3.3 trap public Ruijie(config)# rmon event 1 description rising-threshold-event log trap public owner admin Ruijie(config)# rmon event 2 description falling-threshold-event log owner admin Ruijie(config)# rmon alarm 1 1.3.6.1.2.1.2.2.1.15.3 60 delta rising-threshold 100 1 falling-threshold 10 2 owner admin</pre> |
| <p>Verification</p> | <ul style="list-style-type: none"> ● Run the show rmon event command to display the event table. ● Run the show rmon alarm command to display the alarm table. |
| <p>Agent</p> | <pre>Ruijie# show rmon event rmon event table: index = 1 description = rising-threshold-event type = 4 community = public lastTimeSent = 0d:0h:0m:0s owner = admin status = 1 index = 2 description = falling-threshold-event</pre> |

```
type = 2
community =
lastTimeSent = 6d:19h:21m:48s
owner = admin
status = 1

rmon log table:
eventIndex = 2
index = 1
logTime = 6d:19h:21m:48s
logDescription = falling-threshold-event

Ruijie# show rmon alarm
rmon alarm table:
index: 1,
interval: 60,
oid = 1.3.6.1.2.1.2.2.1.15.3
sampleType: 2,
alarmValue: 0,
startupAlarm: 3,
risingThreshold: 100,
fallingThreshold: 10,
risingEventIndex: 1,
fallingEventIndex: 2,
owner: admin,
stauts: 1
```

Common Errors

- The entered OID of a monitored object is incorrect, the variable corresponding to the OID does not exist, or the type is not an integer or unsigned integer.
- The upper threshold is smaller than or equal to the lower threshold.

4.5 Monitoring

Displaying

| Description | Command |
|--|--------------------------|
| Displays all RMON configuration information. | show rmon |
| Displays the Ethernet statistical table. | show rmon stats |
| Displays the history control table. | show rmon history |
| Displays the alarm table. | show rmon alarm |
| Displays the event table. | show rmon event |

5 Configuring SNMP

5.1 Overview

Simple Network Management Protocol (SNMP) became a network management standard RFC1157 in August 1988. At present, because many vendors support SNMP, SNMP has in fact become a network management standard and is applicable to the environment where systems of multiple vendors are interconnected. By using SNMP, the network administrator can implement basic functions such as information query for network nodes, network configuration, fault locating, capacity planning, and network monitoring and management.

↳ SNMP Versions

Currently, the following SNMP versions are supported:

- SNMPv1: The first official version of SNMP, which is defined in RFC1157.
- SNMPv2C: Community-based SNMPv2 management architecture, which is defined in RFC1901.
- SNMPv3: SNMPv3 provides the following security features by identifying and encrypting data.
 4. Ensuring that data is not tampered during transmission.
 5. Ensuring that data is transmitted from legal data sources.
 6. Encrypting packets and ensuring data confidentiality.

Protocols and Standards

- RFC 1157, Simple Network Management Protocol (SNMP)
- RFC 1901, Introduction to Community-based SNMPv2
- RFC 2578, Structure of Management Information Version 2 (SMIv2)
- RFC 2579, Textual Conventions for SMIv2
- RFC 3411, An Architecture for Describing Simple Network Management Protocol (SNMP) Management Frameworks
- RFC 3412, Message Processing and Dispatching for the Simple Network Management Protocol (SNMP)
- RFC 3413, Simple Network Management Protocol (SNMP) Applications
- RFC 3414, User-based Security Model (USM) for version 3 of the Simple Network Management Protocol (SNMPv3)
- RFC 3415, View-based Access Control Model (VACM) for the Simple Network Management Protocol (SNMP)
- RFC 3416, Version 2 of the Protocol Operations for the Simple Network Management Protocol (SNMP)
- RFC 3417, Transport Mappings for the Simple Network Management Protocol (SNMP)
- RFC 3418, Management Information Base (MIB) for the Simple Network Management Protocol (SNMP)
- RFC 3419, Textual Conventions for Transport Addresses

5.2 Applications

| Application | Description |
|--|--|
| Managing Network Devices Based on SNMP | Network devices are managed and monitored based on SNMP. |

5.2.1 Managing Network Devices Based on SNMP

Scenario

Take the following figure as an example. Network device A is managed and monitored based on SNMP network manager.

Figure 5-1



| | |
|----------------|--|
| Remarks | A is a network device that needs to be managed. PC is a network management station. |
|----------------|--|

Deployment

The network management station is connected to the managed network devices. On the network management station, users access the Management Information Base (MIB) on the network devices through the SNMP network manager and receive messages actively sent by the network devices to manage and monitor the network devices.

5.3 Features

Basic Concepts

SNMP is an application layer protocol that works in C/S mode. It consists of three parts:

- SNMP network manager
- SNMP agent
- MIB

Figure 5-2 shows the relationship between the network management system (NMS) and the network management agent.

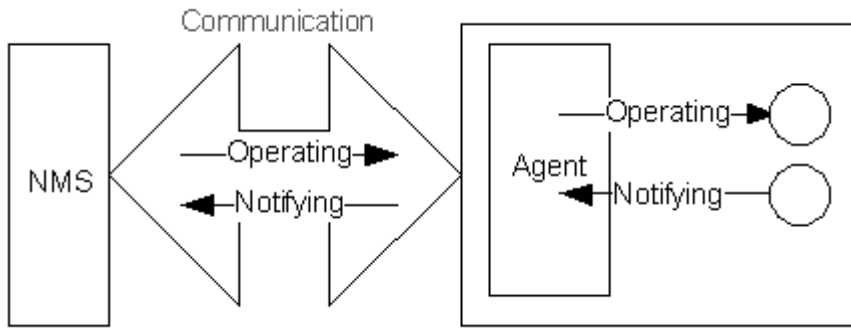

➤ **SNMP Network Manager**

The SNMP network manager is a system that controls and monitors the network based on SNMP and is also called the NMS.

➤ **SNMP Agent**

The SNMP agent (hereinafter referred to as the agent) is software running on the managed devices. It is responsible for receiving, processing, and responding to monitoring and control packets from the NMS. The agent may also actively send messages to the NMS.

➤ **MIB**

The MIB is a virtual network management information base. The managed network devices contain lots of information. To uniquely identify a specific management unit among SNMP packets, the MIB adopts the tree hierarchical structure. Nodes in the tree indicate specific management units. A string of digits may be used to uniquely identify a management unit system among network devices. The MIB is a collection of unit identifiers of network devices.

Figure 5-3 Tree Hierarchical Structure

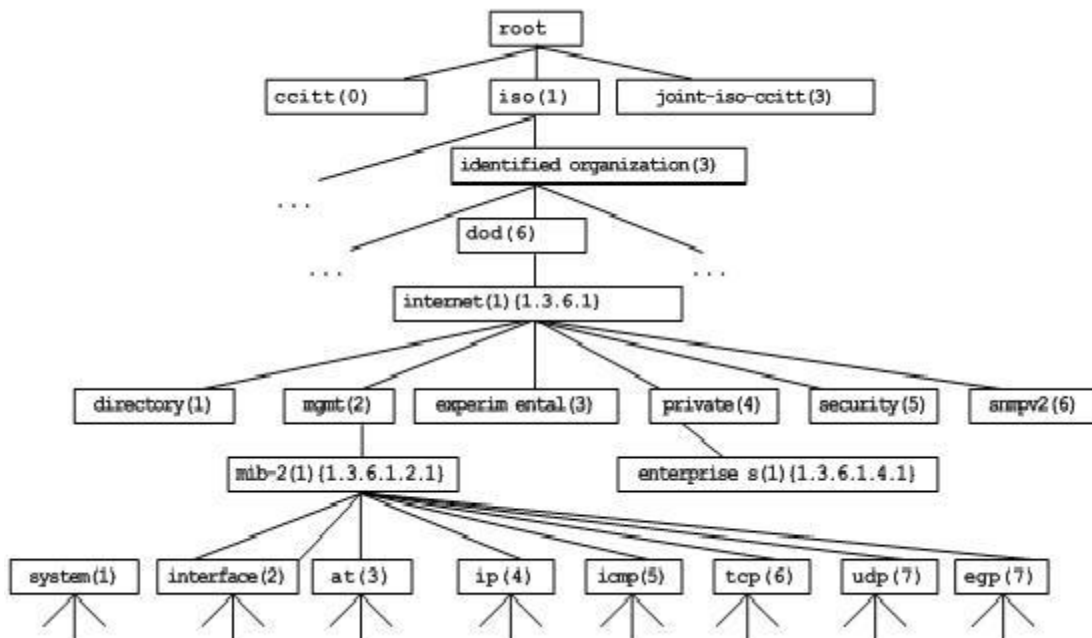

📄 **Operation Types**

Six operation types are defined for information exchange between the NMS and the agent based on SNMP:

- Get-request: The NMS extracts one or more parameter values from the agent.
- Get-next-request: The NMS extracts the parameter value next to one or more parameters from the agent.
- Get-bulk: The NMS extracts a batch of parameter values from the agent.
- Set-request: The NMS sets one or more parameter values of the agent.
- Get-response: The agent returns one or more parameter values, which are the operations in response to the three operations performed by the agent on the NMS.
- Trap: The agent actively sends a message to notify the NMS of something that happens.

The first four packets are sent by the NMS to the agent and the last two packets are sent by the agent to the NMS. (Note: SNMPv1 does not support the Get-bulk operation.) Figure 5-4 describes the operations.

Figure 5-4 SNMP Packet Types

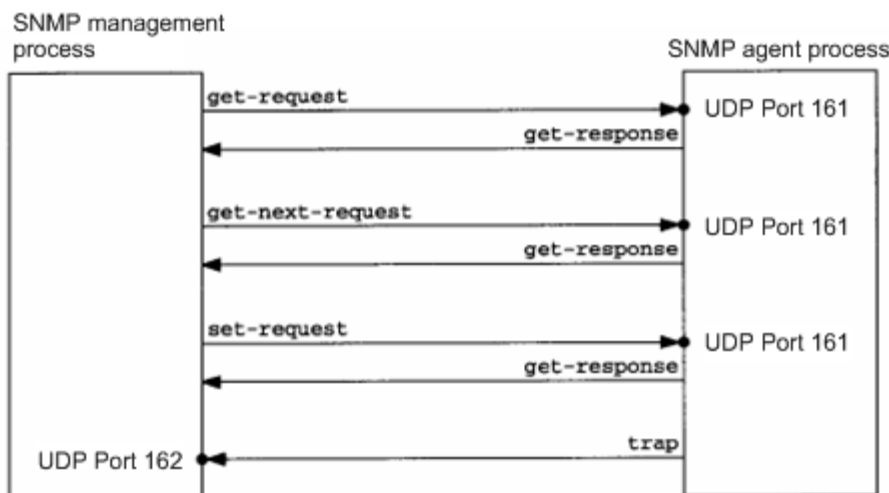

The three operations performed by the NMS on the agent and the response operations of the agent are based on UDP port 161. The trap operation performed by the agent is based on UDP port 162.

Overview

| Feature | Description |
|--------------------------------------|---|
| Basic SNMP Functions | The SNMP agent is configured on network devices to implement basic functions such as information query for network nodes, network configuration, fault locating, and capacity planning. |
| SNMPv1 and SNMPv2C | SNMPv1 and SNMPv2C adopt the community-based security architecture, including authentication name and access permission. |

[SNMPv3](#)

SNMPv3 redefines the SNMP architecture, namely, it enhances security functions, including the security model based on users and access control model based on views. The SNMPv3 architecture already includes all functions of SNMPv1 and SNMPv2C.

5.3.1 Basic SNMP Functions

Working Principle

↳ Working Process

SNMP protocol interaction is response interaction (for exchange of packets, see Figure 5-4). The NMS actively sends requests to the agent, including Get-request, Get-next-request, Get-bulk, and Set-request. The agent receives the requests, completes operations, and returns a Get-response. Sometimes, the agent actively sends a trap message and an Inform message to the NMS. The NMS does not need to respond to the trap message but needs to return an Inform-response to the agent. Otherwise, the agent re-sends the Inform message.

Related Configuration

↳ Shielding or Disabling the SNMP Agent

By default, the SNMP function is enabled.

The **no snmp-server** command is used to disable the SNMP agent.

The **no enable service snmp-agent** command is used to directly disable all SNMP services.

↳ Setting Basic SNMP Parameters

By default, the system contact mode, system location, and device Network Element (NE) information are empty. The default serial number is 60FF60, the default maximum packet length is 1,572 bytes, and the default UDP port ID of the SNMP service is 161.

The **snmp-server contact** command is used to configure or delete the system contact mode.

The **snmp-server location** command is used to configure or delete the system location.

The **snmp-server chassis-id** command is used to configure the system serial number or restore the default value.

The **snmp-server packetsize** command is used to configure the maximum packet length of the agent or restore the default value.

The **snmp-server net-id** command is used to configure or delete the device NE information.

The **snmp-server udp-port** command is used to set the UDP port ID of the SNMP service or restore the default value.

↳ Configuring the SNMP Host Address

By default, no SNMP host is configured.

The **snmp-server host** command is used to configure the NMS host address to which the agent actively sends messages or to delete the specified SNMP host address. In the messages sent to the host, the SNMP version, receiving port, authentication

name, or user can be bound. This command is used with the **snmp-server enable traps** command to actively send trap messages to the NMS.

▾ Setting Trap Message Parameters

By default, SNMP is not allowed to actively send a trap message to the NMS, the function of sending a Link Trap message on an interface is enabled, the function of sending a system reboot trap message is disabled, and a trap message does not carry any private field.

By default, the IP address of the interface where SNMP packets are sent is used as the source address.

By default, the length of a trap message queue is 10 and the interval for sending a trap message is 30s.

The **snmp-server enable traps** command is used to enable or disable the agent to actively send a trap message to the NMS.

The **snmp trap link-status** command is used to enable or disable the function of sending a Link Trap message on an interface.

The **snmp-server trap-source** command is used to specify the source address for sending messages or to restore the default value.

The **snmp-server queue-length** command is used to set the length of a trap message queue or to restore the default value.

The **snmp-server trap-timeout** command is used to set the interval for sending a trap message or to restore the default value.

The **snmp-server trap-format private** command is used to set or disable the function of carrying private fields in a trap message when the message is sent.

The **snmp-server system-shutdown** command is used to enable or disable the function of sending a system reboot trap message.

▾ Setting the SNMP Attack Protection and Detection Function

By default, the SNMP attack protection and detection function is disabled.

The **snmp-server authentication attempt *times* exceed { lock | lock-time *minutes* | unlock }** command is used to set and enable the attack protection and detection function.

5.3.2 SNMPv1 and SNMPv2C

SNMPv1 and SNMPv2C adopt the community-based security architecture. The administrator who can perform operations on the MIB of the agent is limited by defining the host address and authentication name (community string).

Working Principle

SNMPv1 and SNMPv2 determine whether the administrator has the right to use MIB objects by using the authentication name. The authentication name of the NMS must be the same as an authentication name defined in devices.

SNMPv2C adds the Get-bulk operation mechanism and can return more detailed error message types to the management workstation. The Get-bulk operation is performed to obtain all information from a table or obtain lots of data at a time, so as to reduce the number of request responses. The enhanced error handling capabilities of SNMPv2C include extension of error codes to differentiate error types. In SNMPv1, however, only one error code is provided for errors. Now, errors can be differentiated based on error codes. Because management workstations supporting SNMPv1 and SNMPv2C may exist on the

network, the SNMP agent must be able to identify SNMPv1 and SNMPv2C packets and return packets of the corresponding versions.

↳ Security

One authentication name has the following attributes:

- Read-only: Provides the read permission of all MIB variables for authorized management workstations.
- Read-write: Provide the read/write permission of all MIB variables for authorized management workstations.

Related Configuration

↳ Setting Authentication Names and Access Permissions

The default access permission of all authentication names is read-only.

The **snmp-server community** command is used to configure or delete an authentication name and access permission.

This command is the first important command for enabling the SNMP agent function. It specifies community attributes and NMS scope where access to the MIB is allowed.

5.3.3 SNMPv3

SNMPv3 redefines the SNMP architecture and includes functions of SNMPv1 and SNMPv2 into the SNMPv3 system.

Working Principle

The NMS and SNMP agent are SNMP entities. In the SNMPv3 architecture, SNMP entities consist of the SNMP engine and SNMP applications. The SNMP engine is used to send and receive messages, identify and encrypt information, and control access to managed objects. SNMP applications refer to internal applications of SNMP, which work by using the services provided by the SNMP engine.

SNMPv3v determines whether a user has the right to use MIB objects by using the User-based Security Model (USM). The security level of the NMS user must be the same as that of an SNMP user defined in devices so as to manage devices.

SNMPv3 requires the NMS to obtain the SNMP agent engine IDs on devices when the NMS manages devices. SNMPv3 defines the discover and report operation mechanisms. When the NMS does not know agent engine IDs, the NMS may first send a discover message to the agent and the agent returns a report message carrying an engine ID. Later, management operations between the NMS and the agent must carry the engine ID.

↳ Security

- SNMPv3 determines the data security mechanism based on the security model and security level. At present, security models include: SNMPv1, SNMPv2C, and SNMPv3. SNMPv3 includes SNMPv1 and SNMPv2C into the security model.

SNMPv1 and SNMPv2C Security Models and Security Levels

| Security Model | Security Level | Authentication | Encryption | Description |
|----------------|----------------|----------------|------------|-------------|
|----------------|----------------|----------------|------------|-------------|

| | | | | |
|---------|--------------|---------------------|-----|---|
| SNMPv1 | noAuthNoPriv | Authentication name | N/A | Data validity is confirmed through authentication name. |
| SNMPv2c | noAuthNoPriv | Authentication name | N/A | Data validity is confirmed through authentication name. |

SNMPv3 Security Model and Security Level

| Security Model | Security Level | Authentication | Encryption | Description |
|----------------|----------------|----------------|------------|--|
| SNMPv3 | noAuthNoPriv | User name. | N/A | Data validity is confirmed through user name. |
| SNMPv3 | authNoPriv | MD5 or SHA | N/A | The data authentication mechanism based on HMAC-MD5 or HMAC-SHA is provided. |
| SNMPv3 | authPriv | MD5 or SHA | DES | The data authentication mechanism based on HMAC-MD5 or HMAC-SHA and data encryption mechanism based on CBC-DES are provided. |

↘ Engine ID

An engine ID is used to uniquely identify an SNMP engine. Because each SNMP entity includes only one SNMP engine, one SNMP engine uniquely identifies an SNMP entity in a management domain. Therefore, the SNMPv3 agent as an entity must have a unique engine ID, that is, `SnmEngineID`.

An engine ID is an octet string that consists of 5 to 32 bytes. RFC3411 defines the format of an engine ID:

- The first four bytes indicate the private enterprise ID (allocated by IANA) of a vendor, which is expressed in hexadecimal.
- The fifth byte indicates remaining bytes:
- 0: Reserved.
- 1: The later four bytes indicate an IPv4 address.
- 2: The later 16 bytes indicate an IPv6 address.
- 3: The later six bytes indicate a MAC address.
- 4: Text consisting of 27 bytes, which is defined by the vendor.
- 5: Hexadecimal value consisting of 27 bytes, which is defined by the vendor.
- 6-127: Reserved.
- 128-255: Formats specified by the vendor.

Related Configuration

↘ Configuring an MIB View and a Group

By default, one view is configured and all MIB objects can be accessed.

By default, no user group is configured.

The **snmp-server view** command is used to configure or delete a view and the **snmp-server group** command is used to configure or delete a user group.

One or more instructions can be configured to specify different community names so that network devices can be managed by NMSs of different permissions.

📌 Configuring an SNMP User

By default, no user is configured.

The **snmp-server user** command is used to configure or delete a user.

The NMS can communicate with the agent by using only legal users.

An SNMPv3 user can specify the security level (whether authentication and encryption are required), authentication algorithm (MD5 or SHA), authentication password, encryption password (only DES is available currently), and encryption password.

5.3.4 SNMP MIB Cache Function

In unified management mode with multiple devices virtualized into one, the NMS needs to collect MIB variables on the slave/backup device via the master device. The whole collection process takes a long time if there are many devices.

Working Principle

The SNMP MIB cache function can be enabled to reduce the time consumed by the whole collection process. This function enables the master device to collect MIB variables on the slave/backup device in advance and cache the collected MIB variables. In this way, the NMS can directly read the cached MIB variables from the master device, avoid accessing the slave/backup device and reducing the consumed time.

Related Configuration

📌 Configuring SNMP MIB Cache Function

The SNMP MIB cache function is disabled by default.

Run the **snmp-server cache enable** command to configure the SNMP MIB cache function.

📌 Configuring SNMP MIB Cache Update Interval

The cache update interval is 300 seconds by default.

Run the **snmp-server cache update-timer** *seconds* command to configure the SNMP MIB cache update interval.

📌 Enabling Cache Function on Node with Specified OID and Configuring Cache Update Interval of This Node

The MIB cache function is disabled by default. The cache update interval of a node with a specified object identifier (OID) is consistent with the global cache update interval by default.

Run the **snmp-server cache oid** *oid-string* [**update-timer** *seconds*] command to enable the cache function on a node with a specified OID and configure the cache update interval of this node.

5.4 Configuration

| Configuration | Description and Command | |
|--|--|--|
| Configuring Basic SNMP Functions |  (Mandatory) It is used to enable users to access the agent through the NMS. | |
| | enable service snmp-agent | Enables the agent function. |
| | snmp-server community | Sets an authentication name and access permission. |
| | snmp-server user | Configures an SNMP user. |
| | snmp-server view | Configures an SNMP view. |
| | snmp-server group | Configures an SNMP user group. |
| | snmp-server authentication | Configures the SNMP attack protection and detection function. |
| Enabling the Trap Function |  (Optional) It is used to enable the agent to actively send a trap message to the NMS. | |
| | snmp-server host | Configures the NMS host address. |
| | snmp-server enable traps | Enables the agent to actively send a trap message to the NMS. |
| | snmp trap link-status | Enables the function of sending a Link Trap message on an interface. |
| | snmp-server system-shutdown | Enables the function of sending a system reboot trap message. |
| | snmp-server trap-source | Specifies the source address for sending a trap message. |
| | snmp-server trap-format private | Enables a trap message to carry private fields when the message is sent. |
| Shielding the Agent Function |  (Optional) It is used to shield the agent function when the agent service is not required. | |
| | no snmp-server | Shields the agent function. |
| Setting SNMP Control Parameters |  (Optional) It is used to set or modify SNMP control parameters. | |
| | snmp-server contact | Sets the device contact mode. |
| | snmp-server location | Sets the device location. |
| | snmp-server chassis-id | Sets the serial number of the device. |
| | snmp-server net-id | Sets NE information about the device. |
| | snmp-server packetsize | Modifies the maximum packet length. |
| | snmp-server udp-port | Modifies the UDP port ID of the SNMP service. |
| | snmp-server queue-length | Modifies the length of a trap message queue. |
| | snmp-server trap-timeout | Modifies the interval for sending a trap message. |

| Configuration | Description and Command | |
|-------------------------------------|---|--|
| Configuring SNMP MIB Cache Function |  (Optional) It is used to set or modify the SNMP MIB cache function. | |
| | snmp-server cache enable | Configures the global SNMP MIB cache function. |
| | snmp-server cache update-timer | Configures the global SNMP MIB cache update interval. |
| | snmp-server cache oid | Enables the cache function on a node with a specified OID and configures the cache update interval of this node. |

5.4.1 Configuring Basic SNMP Functions

Configuration Effect

Enable users to access the agent through the NMS.

Notes

- By default, no authentication name is set on network devices and SNMPv1 or SNMPv2C cannot be used to access the MIB of network devices. When an authentication name is set, if no access permission is specified, the default access permission is read-only.

Configuration Steps

▾ Configuring an SNMP View

- Optional
- An SNMP view needs to be configured when the View-based Access Control Model (VACM) is used.

▾ Configuring an SNMP User Group

- Optional
- An SNMP user group needs to be configured when the VACM is used.

▾ Configuring an Authentication Name and Access Permission

- Mandatory
- An authentication name must be set on the agent when SNMPv1 and SNMPv2C are used to manage network devices.

▾ Configuring an SNMP User

- Mandatory
- A user must be set when SNMPv3 is used to manage network devices.

▾ Enabling the Agent Function

- Optional
- By default, the agent function is enabled. When the agent function needs to be enabled again after it is disabled, this command must be used.

▾ Enabling the SNMP Attack Protection and Detection Function

- Optional
- By default, the SNMP attack protection and detection function is disabled. When malicious attacks need to be prevented, the configuration item must be used on the agent.

Verification

Run the **show snmp** command to check the SNMP function on devices.

Related Commands

▾ Configuring an SNMP View

| | |
|---------------------|--|
| Command | snmp-server view <i>view-name oid-tree</i> { include exclude } |
| Parameter | <i>view-name</i> : View name |
| Description | <i>oid-tree</i> : MIB objects associated with a view, which are displayed as an MIB subtree. include : Indicates that the MIB object subtree is included in the view. exclude : Indicates that the MIB object subtree is not included in the view. |
| Command Mode | Global configuration mode |
| Usage Guide | Specify a view name and use it for view-based management. |

▾ Configuring an SNMP User Group

| | |
|--------------------|---|
| Command | snmp-server group <i>groupname</i> { v1 v2c v3 { auth noauth priv } } [read <i>readview</i>] [write <i>writeview</i>] [access { ipv6 <i>ipv6-aclname</i> <i>aclnum</i> <i>aclname</i> }] |
| Parameter | v1 v2c v3 : Specifies the SNMP version. |
| Description | auth : Messages sent by users in the group need to be verified but data confidentiality is not required. This configuration is valid for SNMPv3 only. noauth : Messages sent by users in the group do not need to be verified and data confidentiality is not required. This configuration is valid for SNMPv3 only. priv : Messages sent by users in the group need to be verified and confidentiality of transmitted data is required. This configuration is valid for SNMPv3 only. <i>readview</i> : Associates one read-only view. <i>writeview</i> : Associates one read/write view. <i>aclnum</i> : ACL number. The specified ACL is associated and the range of IPv4 NMS addresses from which access to the MIB is allowed is specified. |

| | |
|---------------------|---|
| | <p><i>aclname</i>: ACL name. The specified ACL is associated and the range of IPv4 NMS addresses from which access to the MIB is allowed is specified.</p> <p><i>ipv6-aclname</i>: IPv6 ACL name. The specified ACL is associated and the range of IPv6 NMS addresses from which access to the MIB is allowed is specified.</p> |
| Command Mode | Global configuration mode |
| Usage Guide | Associate certain users with a group and associate the group with a view. Users in a group have the same access permission. In this way, you can determine whether managed objects associated with an operation are in the allowable range of a view. Only managed objects in the range of a view can be accessed. |

📌 **Configuring an Authentication Name and Access Permission**

| | |
|------------------------------|---|
| Command | snmp-server community [0 7] <i>string</i> [view <i>view-name</i>] [[ro rw] [host <i>ipaddr</i>]] [ipv6 <i>ipv6-aclname</i>] [<i>aclnum</i> <i>aclname</i>] |
| Parameter Description | <p>0: Indicates that the input community string is a plaintext string.</p> <p>7: Indicates that the input community string is a ciphertext string.</p> <p><i>string</i>: Community string, which is equivalent to the communication password between the NMS and the SNMP agent.</p> <p><i>view-name</i>: Specifies a view name for view-based management.</p> <p>ro: Indicates that the NMS can only read variables of the MIB.</p> <p>rw: The NMS can read and write variables of the MIB.</p> <p><i>aclnum</i>: ACL number. The specified ACL is associated and the range of IPv4 NMS addresses from which access to the MIB is allowed is specified.</p> <p><i>aclname</i>: ACL name. The specified ACL is associated and the range of IPv4 NMS addresses from which access to the MIB is allowed is specified.</p> <p><i>ipv6-aclname</i>: ACL name. The specified ACL is associated and the range of IPv6 NMS addresses from which access to the MIB is allowed is specified.</p> <p><i>ipaddr</i>: Associates NMS addresses and specifies NMS addresses for accessing the MIB.</p> |
| Command Mode | Global configuration mode |
| Usage Guide | <p>This command is the first important command for enabling the SNMP agent function. It specifies community attributes and NMS scope where access to the MIB is allowed.</p> <p>To disable the SNMP agent function, run the no snmp-server command.</p> |

📌 **Configuring an SNMP User**

| | |
|------------------------------|--|
| Command | snmp-server user <i>username</i> <i>groupname</i> { v1 v2c v3 [encrypted] [auth { md5 sha } <i>auth-password</i>] [priv des56 <i>priv-password</i>] } [access { ipv6 <i>ipv6-aclname</i> <i>aclnum</i> <i>aclname</i> }] |
| Parameter Description | <p><i>username</i>: User name.</p> <p><i>groupname</i>: Specifies the group name for a user.</p> <p>v1 v2c v3: Specifies the SNMP version. Only SNMPv3 supports later security parameters.</p> |

| | |
|---------------------|---|
| | <p>encrypted: The specified password input mode is ciphertext input. Otherwise, plaintext is used for input. If ciphertext input is selected, enter a key consisting of continuous hexadecimal digits. An MD5 protocol authentication key consists of 16 bytes and an SHA authentication protocol key consists of 20 bytes. Two characters stand for one byte. Encrypted keys are valid for this engine only.</p> <p>auth: Specifies whether authentication is used.</p> <p>md5: Specifies the MD5 authentication protocol. sha specifies the SHA authentication protocol.</p> <p><i>auth-password:</i> Configures a password string (not more than 32 characters) used by the authentication protocol. The system converts the passwords into the corresponding authentication keys.</p> <p>priv: Specifies whether confidentiality is used. des56 specifies the use of the 56-bit DES encryption protocol.</p> <p><i>priv-password:</i> Configures a password string (not more than 32 characters) used for encryption. The system converts the password into the corresponding encryption key.</p> <p><i>aclnum:</i> ACL number. The specified ACL is associated and the range of IPv4 NMS addresses from which access to the MIB is allowed is specified.</p> <p><i>aclname:</i> ACL name. The specified ACL is associated and the range of IPv4 NMS addresses from which access to the MIB is allowed is specified.</p> <p><i>ipv6-aclname:</i> IPv6 ACL name. The specified ACL is associated and the range of IPv6 NMS addresses from which access to the MIB is allowed is specified.</p> |
| Command Mode | Global configuration mode |
| Usage Guide | Configure user information so that the NMS can communicate with the agent by using a valid user. For an SNMPv3 user, you can specify the security level, authentication algorithm (MD5 or SHA), authentication password, encryption algorithm (at present, only DES is available), and encryption password. |

▾ Enabling the Agent Function

| | |
|------------------------------|---|
| Command | enable service snmp-agent |
| Parameter Description | |
| Configuration mode | Privileged mode. |
| Usage Guide | This command is used to enable the SNMP agent function of a device. |

▾ Enabling the SNMP Attack Protection and Detection Function

| | |
|------------------------------|--|
| Command | snmp-server authentication attempt <i>times</i> exceed { lock lock-time <i>minutes</i> unlock } |
| Parameter Description | <p><i>times:</i> Number of continuous failed attempts.</p> <p>lock: After continuous authentication fails, the source IP address is permanently forbidden to initiate authentication for access. The administrator needs to manually unlock the IP address.</p> |

| | |
|---------------------|--|
| | <p>lock-time <i>minutes</i>: After continuous authentication fails, the source IP address is forbidden to initiate authentication for access in a period of time. Beyond the period, the source IP address can be authenticated for access again.</p> <p>unlock: After continuous authentication fails, the source IP address is allowed to access the MIB continuously, which is equivalent to the fact that the SNMP attack protection and detection function is not configured.</p> |
| Command Mode | Global configuration mode |
| Usage Guide | <p>Configure the SNMP attack protection and detection function so that the corresponding measure can be taken after continuous authentication fails.</p> <p>The permanently forbidden source IP addresses can be authenticated for access again only after the administrator manually unlocks the IP addresses.</p> <p>The source IP address that are forbidden to access the MIB in a period of time can be authenticated for access again after the period expires or after the administrator manually unlocks the IP addresses.</p> |

▾ **Displaying the SNMP Status Information**

| | |
|------------------------------|---|
| Command | show snmp [mib user view group host locked-ip process-mib-time] |
| Parameter Description | <p>mib: Displays information about the SNMP MIB supported in the system.</p> <p>user: Displays information about an SNMP user.</p> <p>view: Displays information about an SNMP view.</p> <p>group: Displays information about an SNMP user group.</p> <p>host: Displays information about user configuration.</p> <p>locked-ip: Source IP address that is locked after continuous authentication fails.</p> <p>process-mib-time: Displays the MIB node with the longest processing time.</p> |
| Configuration mode | Privileged mode. |
| Usage Guide | N/A |

▾ **Configuring SNMPv3 Configuration**

| | |
|----------------------------|--|
| Scenario Figure 5-5 | <div style="text-align: center;"> <p>The diagram illustrates a network connection between an Agent and an NMS. The Agent is represented by a blue square icon with a crosshair, and the NMS is represented by a blue server rack icon. They are connected by a horizontal line labeled 'Gi0/1'. Below the Agent icon is the IP address 'IP:192.168.3.1/24', and below the NMS icon is the IP address 'IP:192.168.3.2/24'.</p> </div> <ul style="list-style-type: none"> The NMS manages network devices (agents) based on the user authentication and encryption mode, for example, the NMS uses user1 as the user name, MD5 as the authentication mode, 123 as the authentication password, DES56 as the encryption algorithm, and 321 as the encryption password. |
|----------------------------|--|

| | |
|-----------------------------------|--|
| | <ul style="list-style-type: none"> ● Network devices can control the operation permission of users to access MIB objects. For example, the user named user1 can read MIB objects under the system node (1.3.6.1.2.1.1) and can only write MIB objects under the SysContact node (1.3.6.1.2.1.1.4.0). ● Network devices can actively send authentication and encryption messages to the NMS. |
| <p>Configuration Steps</p> | <ul style="list-style-type: none"> ● Configure a MIB view and a MIB group. Create a MIB view “view1”, which includes the associated MIB object (1.3.6.1.2.1.1); then create a MIB view “view2”, which includes the associated MIB object (1.3.6.1.2.1.1.4.0). Create a group “g1”, select the version “v3”, set the security level to the authentication and encryption mode “priv”, and configure permissions to read the view “view1” and write the view “view2”. ● Configure an SNMP user. Create a user named “user1” under group “g1”, select “v3” as the version, and set the authentication mode to “md5”, authentication password to “123”, encryption mode to “DES56”, and encryption password to “321”. ● Configure the SNMP host address. Set the host address to 192.168.3.2, select “3” as the version, set the security level to the authentication and encryption mode “priv”, and associate the user name “user1”. Enable the agent to actively send a trap message to the NMS. ● Set the IP address of the agent. Set the address of the Gi0/1 interface to 192.168.3.1/24. |
| <p>Agent</p> | <pre>Ruijie(config)#snmp-server view view1 1.3.6.1.2.1.1 include Ruijie(config)#snmp-server view view2 1.3.6.1.2.1.1.4.0 include Ruijie(config)#snmp-server group g1 v3 priv read view1 write view2 Ruijie(config)#snmp-server user user1 g1 v3 auth md5 123 priv des56 321 Ruijie(config)#snmp-server host 192.168.3.2 traps version 3 priv user1 Ruijie(config)#snmp-server enable traps Ruijie(config)#interface gigabitEthernet 0/1 Ruijie(config-if-gigabitEthernet 0/1)#ip address 192.168.3.1 255.255.255.0 Ruijie(config-if-gigabitEthernet 0/1)#exit</pre> |
| <p>Verification</p> | <ol style="list-style-type: none"> 1. Run the show running-config command to display configuration information of the device. 2. Run the show snmp user command to display the SNMP user. 3. Run the show snmp view command to display the SNMP view. 4. Run the show snmp group command to display the SNMP group. 5. Run the show snmp host command to display the host information configured by the user. 6. Install MIB-Browser. |
| <p>Agent</p> | <pre>Ruijie# show running-config ! interface gigabitEthernet 0/1 no ip proxy-arp ip address 192.168.3.1 255.255.255.0 ! snmp-server view view1 1.3.6.1.2.1.1 include</pre> |

| | |
|--|---|
| | <pre>snmp-server view view2 1.3.6.1.2.1.1.4.0 include snmp-server user user1 gl v3 encrypted auth md5 7EBD6A1287D3548E4E52CF8349CBC93D priv des56 D5CEC4884360373ABBF30AB170E42D03 snmp-server group gl v3 priv read view1 write view2 snmp-server host 192.168.3.2 traps version 3 priv user1 snmp-server enable traps</pre> |
| | <pre>Ruijie# show snmp user User name: user1 Engine ID: 800013110300d0f8221120 storage-type: permanent active Security level: auth priv Auth protocol: MD5 Priv protocol: DES Group-name: gl</pre> |
| | <pre>Ruijie#show snmp view view1(include) 1.3.6.1.2.1.1 view2(include) 1.3.6.1.2.1.1.4.0 default(include) 1.3.6.1</pre> |
| | <pre>Ruijie# show snmp group groupname: gl securityModel: v3 securityLevel:authPriv readview: view1 writeview: view2 notifyview:</pre> |
| | <pre>Ruijie#show snmp host Notification host: 192.168.3.2 udp-port: 162 type: trap user: user1 security model: v3 authPriv</pre> |
| | <p>Install MIB-Browser, enter IP address 192.168.3.1 in IP Address and user1 in UserName, select AuthPriv for Security Level, enter 123 in AuthPassWord, select MD5 for AuthProtocol, and enter 321 in PrivPassWord. Click Add Item and select a management unit for which the MIB needs to be queried, for example, System in the following figure. Click Start. The MIB is queried for</p> |

network devices. The lowest pane in the following figure shows query results.

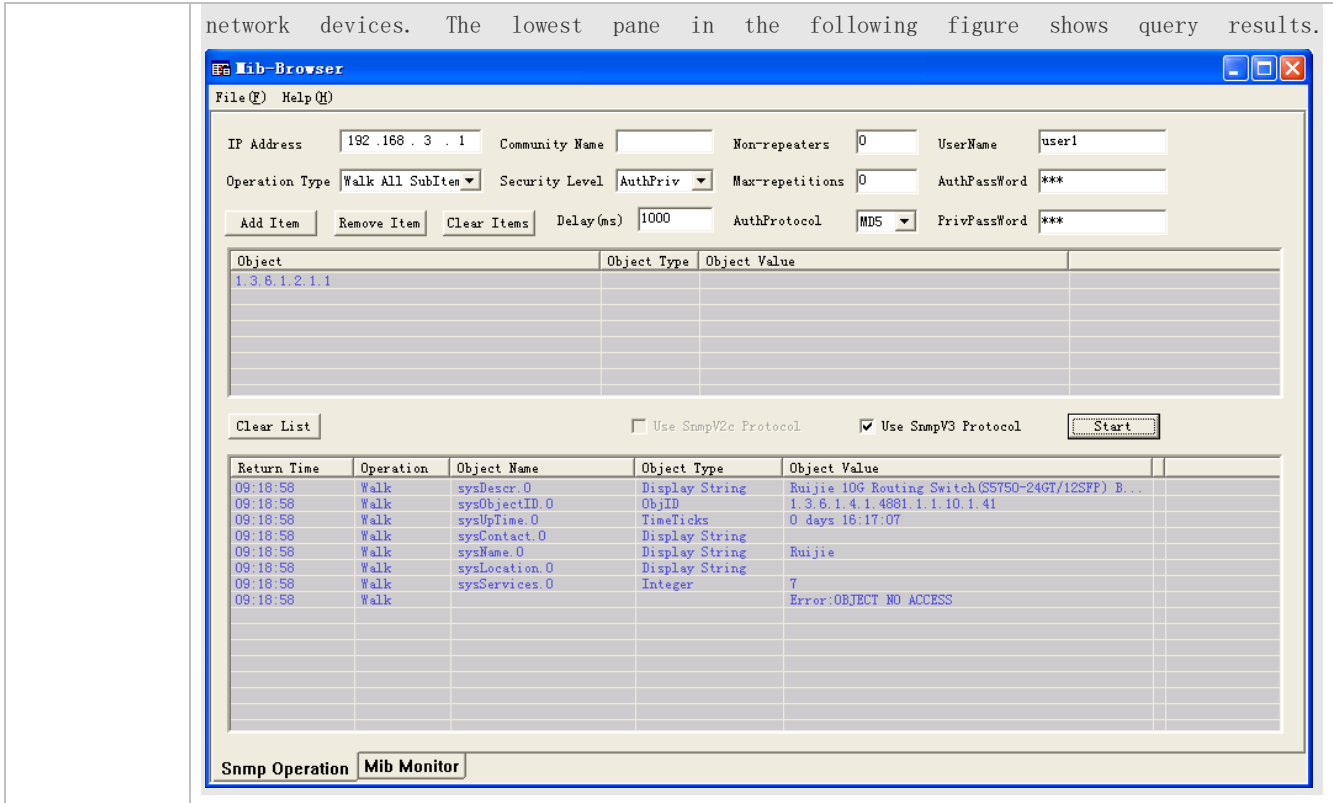

Common Errors

-

5.4.2 Enabling the Trap Function

Configuration Effect

Enable the agent to actively send a trap message to the NMS.

Notes

N/A

Configuration Steps

➤ **Configuring the SNMP Host Address**

- Optional
- Configure the host address of the NMS when the agent is required to actively send messages.

➤ **Enabling the Agent to Actively Send a Trap Message to the NMS**

- Optional

- Configure this item on the agent when the agent is required to actively send a trap message to the NMS.

↘ **Enabling the Function of Sending a Link Trap Message on an Interface**

- Optional
- Configure this item on the agent when a link trap message needs to be sent on an interface.

↘ **Enabling the Function of Sending a System Reboot Trap Message**

- Optional
- Configure this item on the agent when the RGOS system is required to send a trap message to the NMS to notify system reboot before reloading or reboot of the device.

↘ **Specifying the Source Address for Sending a Trap Message**

- Optional
- Configure this item on the agent when it is required to permanently use a local IP address as the source SNMP address to facilitate management.

↘ **Enabling a Trap Message to Carry Private Fields when the Message Is Sent**

- Optional
- Configure this item on the agent when private fields need to be carried in a trap message.

Verification

Run the **show snmp** command to display the SNMP status.

Run the **show running-config** command to display configuration information of the device.

Related Commands

↘ **Setting the NMS Host Address**

| | |
|--------------------|---|
| Command | snmp-server host { <i>host-addr</i> ipv6 <i>ipv6-addr</i> } [traps informs] [version { 1 2c 3 { auth noauth priv }] <i>community-string</i> [udp-port <i>port-num</i>] [<i>notification-type</i>] |
| Parameter | <i>host-addr</i> : Address of the SNMP host. |
| Description | <p><i>ipv6-addr</i>: (IPv6) address of the SNMP host.</p> <p>traps informs: Configures the host to send a trap message or an inform message.</p> <p>version: SNMP version, which can be set to V1, V2C, or V3.</p> <p>auth noauth priv: Sets the security level of V3 users.</p> <p><i>community-string</i>: Community string or user name (V3).</p> <p><i>port-num</i>: Configures the port ID of the SNMP host.</p> <p><i>notification-type</i>: Type of trap messages that are actively sent, for example, snmp.</p> <hr/> <p> If no trap type is specified, all trap messages are sent.</p> |

| | |
|---------------------|---|
| Command Mode | Global configuration mode |
| Usage Guide | <p>This command is used with the snmp-server enable traps command to actively send trap messages to the NMS.</p> <p>You can configure different SNMP hosts to receive trap messages. A host can support different traps and ports. If the same host is configured, the last configuration is combined with the previous configurations, that is, to send different trap messages to the same host, configure one type of trap messages each time. These configurations are finally combined.</p> |

▾ Enabling the Agent to Actively Send a Trap Message to the NMS

| | |
|------------------------------|--|
| Command | snmp-server enable traps [<i>notification-type</i>] |
| Parameter Description | <p><i>notification-type</i>: Enables trap notification for the corresponding events, including the following types:</p> <p>snmp: Enables trap notification for SNMP events.</p> <p>bridge: Enables trap notification for bridge events.</p> <p>mac-notification: Enables trap notification for MAC events.</p> <p>ospf: Enables trap notification for OSPF events.</p> <p>urpf: Enables trap notification for URPF events.</p> <p>vrrp: Enables trap notification for VRRP events.</p> <p>web-auth: Enables trap notification for Web authentication events.</p> |
| Command Mode | Global configuration mode |
| Usage Guide | This command must be used with the snmp-server host command to so that trap messages can be actively sent. |

▾ Enabling the Function of Sending a Link Trap Message on an Interface

| | |
|------------------------------|--|
| Command | snmp trap link-status |
| Parameter Description | - |
| Configuration mode | Interface configuration mode |
| Usage Guide | For interfaces (Ethernet interface, AP interface, and SVI interface), when this function is enabled, the SNMP sends a Link Trap message if the link status on the interfaces changes. Otherwise, the SNMP does not send the message. |

▾ Enabling the Function of Sending a System Reboot Trap Message

| | |
|------------------------------|------------------------------------|
| Command | snmp-server system-shutdown |
| Parameter Description | - |
| Configuration mode | Global configuration mode |

| | |
|--------------------|---|
| Usage Guide | When the function of notification upon SNMP system reboot is enabled, a trap message is sent to the NMS to notify system reboot before reloading or reboot of the device. |
|--------------------|---|

↘ Specifying the Source Address for Sending a Trap Message

| | |
|------------------------------|---|
| Command | snmp-server trap-source <i>interface</i> |
| Parameter Description | <i>interface</i> : Used as the interface for the SNMP source address. |
| Configuration mode | Global configuration mode |
| Usage Guide | By default, the IP address of the interface where SNMP packets are sent is used as the source address. To facilitate management and identification, this command can be run to permanently use one local IP address as the source SNMP address. |

↘ Enabling a Trap message to Carry Private Fields when the Message Is Sent

| | |
|------------------------------|--|
| Command | snmp-server trap-format private |
| Parameter Description | N/A |
| Configuration mode | Global configuration mode |
| Usage Guide | This command can be used to enable a trap message to carry private fields when the message is sent. At present, supported private fields include the alarm generation time. For the specific data types and data ranges of the fields, see RUIJIE-TRAP-FORMAT-MIB.mib. |

Configuration Example

↘ Enabling the Trap Function

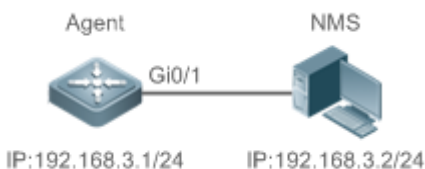
| | |
|-------------------------------|---|
| Scenario Figure 5-6 |  <p>● The NMS manages network devices (agents) based on the community authentication mode, and network devices can actively send messages to the NMS.</p> |
| Configuration Steps | <ol style="list-style-type: none"> Perform configuration to enable the agent to actively send messages to the NMS. Set the SNMP host address to 192.168.3.2, the message format to Version2c, and the authentication name to user1. Enable the agent to actively send trap messages. Set the IP address of the agent. Set the address of the Gi0/1 interface to 192.168.3.1/24. |
| Agent | <pre>Ruijie(config)#snmp-server host 192.168.3.2 traps version 2c user1 Ruijie(config)#snmp-server enable traps Ruijie(config)#interface gigabitEthernet 0/1</pre> |

| | |
|---------------------|---|
| | <pre>Ruijie(config-if-gigabitEthernet 0/1)#ip address 192.168.3.1 255.255.255.0 Ruijie(config-if-gigabitEthernet 0/1)#exit</pre> |
| | |
| Verification | <ul style="list-style-type: none"> ● Run the show running-config command to display configuration information of the device. ● Run the show snmp command to display the SNMP status. |
| Agent | <pre>Ruijie# show running-config ip access-list standard al 10 permit host 192.168.3.2 interface gigabitEthernet 0/1 no ip proxy-arp ip address 192.168.3.1 255.255.255.0 snmp-server view v1 1.3.6.1.2.1.1 include snmp-server location fuzhou snmp-server host 192.168.3.2 traps version 2c user1 snmp-server enable traps snmp-server contact ruijie.com.cn snmp-server community user1 view v1 rw al snmp-server chassis-id 1234567890</pre> |
| | <pre>Ruijie#show snmp Chassis: 1234567890 0 SNMP packets input 0 Bad SNMP version errors 0 Unknown community name 0 Illegal operation for community name supplied 0 Encoding errors 0 Number of requested variables 0 Number of altered variables 0 Get-request PDUs 0 Get-next PDUs 0 Set-request PDUs 0 SNMP packets output 0 Too big errors (Maximum packet size 1472) 0 No such name errors 0 Bad values errors 0 General errors 0 Response PDUs 0 Trap PDUs SNMP global trap: enabled SNMP logging: disabled SNMP agent: enabled</pre> |

Common Errors

N/A

5.4.3 Shielding the Agent Function

Configuration Effect

Shield the agent function when the agent service is not required.

Notes

- Run the **no snmp-server** command to shield the SNMP agent function when the agent service is not required.
- Different from the shielding command, after the **no enable service snmp-agent** command is run, all SNMP services are directly disabled (that is, the SNMP agent function is disabled, no packet is received, and no response packet or trap packet is sent), but configuration information of the agent is not shielded.

Configuration Steps

Shielding the SNMP Agent Function for the Device

- Optional
- To shield the configuration of all SNMP agent services, use this configuration.

Disabling the SNMP Agent Function for the Device

- Optional
- To directly disable all services, use this configuration.

Verification

Run the **show services** command to check whether SNMP services are enabled or disabled.

Run the **show snmp** command to display the SNMP status.

Run the **show running-config** command to display configuration information of the device.

Related Commands

Shielding the SNMP Agent Function for the Device

| | |
|------------------------------|--|
| Command | no snmp-server |
| Parameter Description | N/A |
| Command Mode | Global configuration mode |
| Usage Guide | By default, the SNMP agent function is disabled. When SNMP agent parameters (for example, NMS host address, authentication name, and access permission) are set, the SNMP agent service is automatically |

enabled. The **enable service snmp-agent** command must also be run at the same time so that the SNMP agent service can take effect. If the SNMP agent service is disabled or the **enable service snmp-agent** command is not run, the SNMP agent service does not take effect. Run the **no snmp-server** command to disable SNMP agent services of all versions supported by the device.

After this command is run, all SNMP agent service configurations are shielded (that is, after the **show running-config** command is run, no configuration is displayed. Configurations are restored after the SNMP agent service is enabled again). After the **enable service snmp-agent** command is run, the SNMP agent configurations are not shielded.

↘ **Disabling the SNMP Agent Function for the Device**

| | |
|------------------------------|---|
| Command | no enable service snmp-agent |
| Parameter Description | N/A |
| Configuration mode | Global configuration mode |
| Usage Guide | disable the SNMP service, but it will not shield SNMP agent parameters. |

Configuration Example

↘ **Enabling the SNMP Service**

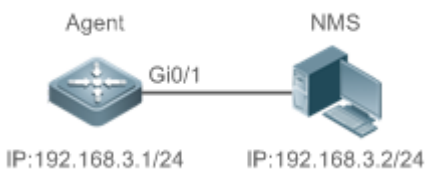
| | |
|-------------------------------|--|
| Scenario Figure 5-7 |  <p>After the SNMP service is enabled and the SNMP agent server is set, the NMS can access devices based on SNMP.</p> |
| Configuration Steps | <ol style="list-style-type: none"> 1. Enable the SNMP service. 2. Set parameters for the SNMP agent server to make the SNMP service take effect. |
| Agent | <code>Ruijie(config)#enable service snmp-agent</code> |
| Verification | 1. Run the show services command to check whether the SNMP service is enabled or disabled. |
| Agent | <pre>Ruijie#show service web-server : disabled web-server(https): disabled snmp-agent : enabled ssh-server : disabled telnet-server : enabled</pre> |

Common Errors

N/A

5.4.4 Setting SNMP Control Parameters

Configuration Effect

Set basic parameters of the SNMP agent, including the device contact mode, device location, serial number, and parameters for sending a trap message. By accessing the parameters, the NMS can obtain the contact person of the device and physical location of the device.

Notes

N/A

Configuration Steps

▾ Setting the System Contact Mode

- Optional
- When the contact mode of the system needs to be modified, configure this item on the agent.

▾ Setting the System Location

- Optional
- When the system location needs to be modified, configure this item on the agent.

▾ Setting the System Serial Number

- Optional
- When the system serial number needs to be modified, configure this item on the agent.

▾ Setting NE Information about the Device

- Optional
- When the NE code needs to be modified, configure this item on the agent.

▾ Setting the Maximum Packet Length of the SNMP Agent

- Optional
- When the maximum packet length of the SNMP agent needs to be modified, configure this item on the agent.

▾ Setting the UDP Port ID of the SNMP Service

- Optional
- When the UDP port ID of the SNMP service needs to be modified, configure this item on the agent.

▾ Setting the Queue Length of Trap Messages

- Optional
- When the size of the message queue needs to be adjusted to control the message sending speed, configure this item on the agent.

▾ Setting the Interval for Sending a Trap Message

- Optional
- When the interval for sending a trap message needs to be modified, configure this item on the agent.

▾ Configuring SNMP Flow Control

- Optional
- If a large number of SNMP request packets result in high CPU usage for SNMP tasks, configure SNMP flow control to limit the number of request packets processed per second in each SNMP task, so as to control the CPU usage for SNMP tasks.

Verification

Run the **show snmp** command to display the SNMP status.

Run the **show running-config** command to display configuration information of the device.

Related Commands

▾ Setting the System Contact Mode

| | |
|------------------------------|--|
| Command | snmp-server contact <i>text</i> |
| Parameter Description | <i>text</i> : String that describes the system contact mode. |
| Command Mode | Global configuration mode |
| Usage Guide | N/A |

▾ Setting the System Location

| | |
|------------------------------|---|
| Command | snmp-server location <i>text</i> |
| Parameter Description | <i>text</i> : String that describes system information. |
| Configuration mode | Global configuration mode |
| Usage Guide | N/A |

▾ Setting the System Serial Number

| | |
|----------------|---|
| Command | snmp-server chassis-id <i>text</i> |
|----------------|---|

| | |
|------------------------------|--|
| Parameter Description | <i>text</i> : Text of the system serial number, which may be digits or characters. |
| Configuration mode | Global configuration mode |
| Usage Guide | In general, the device serial number is used as the SNMP serial number to facilitate identification of the device. |

Setting NE Information about the Device

| | |
|------------------------------|--|
| Command | snmp-server net-id <i>text</i> |
| Parameter Description | <i>text</i> : Text that is used to set the device NE code. The text is a string that consists of 1 to 255 characters that are case-sensitive and may include spaces. |
| Configuration mode | Global mode. |
| Usage Guide | Set the NE code of the device. |

Setting the Maximum Packet Length of the SNMP Agent

| | |
|------------------------------|--|
| Command | snmp-server packet-size <i>byte-count</i> |
| Parameter Description | <i>byte-count</i> : Packet size, ranging from 484 bytes to 17,876 bytes. |
| Configuration mode | Global mode. |
| Usage Guide | N/A |

Setting the UDP Port ID of the SNMP Service

| | |
|------------------------------|---|
| Command | snmp-server udp-port <i>port-num</i> |
| Parameter Description | <i>port-num</i> : Specifies the UDP port ID of the SNMP service, that is, the ID of the protocol port that receives SNMP packets. |
| Configuration mode | Global mode. |
| Usage Guide | Specify the protocol port ID for receiving SNMP packets. |

Setting the Length of a Trap Message Queue

| | |
|------------------------------|--|
| Command | snmp-server queue-length <i>length</i> |
| Parameter Description | <i>length</i> : Queue length, ranging from 1 to 1,000. |
| Configuration mode | Global configuration mode |
| Usage Guide | Adjust the size of the message queue to control the message sending speed. |

Setting the Interval for Sending a Trap Message

| | |
|------------------------------|---|
| Command | snmp-server trap-timeout <i>seconds</i> |
| Parameter Description | <i>seconds</i> : Interval (unit: second). The value range is 1 to 1,000. |
| Configuration mode | Global configuration mode |
| Usage Guide | Adjust the interval for sending a message to control the message sending speed. |

▾ **Configuring SNMP Flow Control**

| | |
|------------------------------|--|
| Command | snmp-server flow-control pps [<i>count</i>] |
| Parameter Description | <i>count</i> : Number of SNMP request packets processed per second. The value range is 50 to 65,535. |
| Command Mode | Global configuration mode |
| Usage Guide | If a large number of SNMP request packets result in high CPU usage for SNMP tasks, configure SNMP flow control to limit the number of request packets processed per second in each SNMP task, so as to control the CPU usage for SNMP tasks. |

Configuration Example

▾ **Setting SNMP Control Parameters**

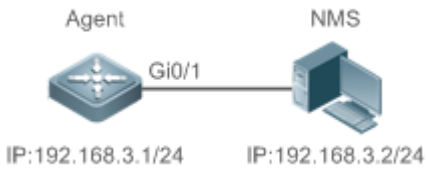
| | |
|-------------------------------|--|
| Scenario Figure 5-8 |  <p>● The NMS manages network devices (agents) based on the community authentication mode and can obtain basic system information about the devices, for example, system contact mode, location, and serial number.</p> |
| Configuration Steps | <ol style="list-style-type: none"> 1. Set SNMP agent parameters. Set the system location, contact mode, and serial number. 2. Set the IP address of the agent. Set the address of the Gi0/1 interface to 192.168.3.1/24. |
| Agent | <pre>Ruijie(config)#snmp-server location fuzhou Ruijie(config)#snmp-server contact ruijie.com.cn Ruijie(config)#snmp-server chassis-id 1234567890 Ruijie(config)#interface gigabitEthernet 0/1 Ruijie(config-if-gigabitEthernet 0/1)#ip address 192.168.3.1 255.255.255.0 Ruijie(config-if-gigabitEthernet 0/1)#exit</pre> |
| Verification | <ol style="list-style-type: none"> 1. Check the configuration information of the device. 2. Check the SNMP view and group information. |

| | |
|--------------|---|
| Agent | <pre> Ruijie# show running-config ip access-list standard al 10 permit host 192.168.3.2 interface gigabitEthernet 0/1 no ip proxy-arp ip address 192.168.3.1 255.255.255.0 snmp-server view vl 1.3.6.1.2.1.1 include snmp-server location fuzhou snmp-server host 192.168.3.2 traps version 2c user1 snmp-server enable traps snmp-server contact ruijie.com.cn snmp-server community user1 view vl rw al snmp-server chassis-id 1234567890 </pre> |
| | <pre> Ruijie#show snmp view vl(include) 1.3.6.1.2.1.1 default(include) 1.3.6.1 Ruijie#show snmp group groupname: user1 securityModel: v1 securityLevel:noAuthNoPriv readview: vl writeview: vl notifyview: groupname: user1 securityModel: v2c securityLevel:noAuthNoPriv readview: vl writeview: vl notifyview: </pre> |

Common Errors

N/A

5.4.5 Configuring SNMP MIB Cache Function

Configuration Effect

Enable the SNMP MIB cache function to increase the speed of obtaining MIB data by the NMS. This function enables the master device to collect MIB variables on the slave/backup device in advance and cache the collected MIB variables. In this way, the NMS can directly read the cached MIB variables from the master device, avoid accessing the slave/backup device and reducing the consumed time.

Notes

- The SNMP MIB cache function applies only to MIB nodes with specific table variables. To configure this function, only the OID of the root node of the MIB table variables needs to be configured.
- After the cache function is enabled, the cache is updated periodically, and the MIB data is not collected in real time. An excessively short cache update interval may cause frequent cache update operations in the system, which consumes many CPU resources; on the contrary, an excessively long cache update interval may delay MIB data updates, which fails to reflect the system status in real time. Therefore, the cache update interval needs to be adjusted according to the real-time performance of the MIB nodes and the CPU resources.

Configuration Steps

▾ Configuring Global SNMP MIB Cache Function

- Optional.
- The SNMP MIB cache function is disabled by default. You can enable the MIB cache function globally.

▾ Configuring Global SNMP MIB Cache Update Interval

- Optional.
- The global SNMP MIB cache update interval is 300 seconds by default. You can configure the global cache update interval.

▾ Enabling Cache Function on Node with Specified OID and Configuring Cache Update Interval of This Node

- Optional.
- The cache function is disabled on all MIB nodes by default. You can enable the MIB cache function on a specified MIB node.

Verification

Run the **show running-config** command to display the configuration information of the device.

Related Commands

▾ Configuring Global SNMP MIB Cache Function.

| | |
|---------------------|---------------------------------|
| Command | snmp-server cache enable |
| Parameter | N/A |
| Description | |
| Command Mode | Global configuration mode |
| Usage Guide | |

▾ Configuring Global SNMP MIB Cache Update Interval

| | |
|----------------|--|
| Command | snmp-server cache update-timer <i>seconds</i> |
|----------------|--|

| | |
|------------------------------|---|
| Parameter Description | <i>seconds</i> : Specifies the global SNMP MIB cache update interval in seconds. The value ranges from 60 to 3,600. |
| Configuration Mode | Global configuration mode |
| Usage Guide | |

▾ **Enabling Cache Function on Node with Specified OID and Configuring Cache Update Interval of This Node**

| | |
|------------------------------|---|
| Command | snmp-server cache oid <i>oid-string</i> [update-timer <i>seconds</i>] |
| Parameter Description | <i>oid-string</i> : Specifies the OID of the MIB node. <i>seconds</i> : Specifies the cache update interval in seconds. The value ranges from 60 to 3,600. |
| Configuration Mode | Global configuration mode |
| Usage Guide | The cache update interval of the MIB node, if not configured, is consistent with the global cache update interval |

Configuration Example

▾ **Setting SNMP Control Parameters**

| | |
|-------------------------------|--|
| Scenario Figure 5-9 | <p>The diagram shows an SNMP Agent consisting of three nodes: Slave, Master, and Backup. These nodes are connected to an NMS (Network Management System) via a link labeled Gi0/1. The NMS has an IP address of 192.168.3.2/24. The SNMP Agent has an IP address of 192.168.3.1/24.</p> <ul style="list-style-type: none"> The NMS manages the SNMP agent based on the community authentication mode. The NMS can obtain the MIB node information of the SNMP agent, such as the connection statuses of the AP and STA. |
| Configuration Steps | <ol style="list-style-type: none"> 1. Configure the global SNMP MIB cache function. 2. Configure the global SNMP MIB cache update interval. 3. Enable the cache function on a node with a specified OID. |
| Agent | <pre>Ruijie(config)# snmp-server cache enable Ruijie(config)# snmp-server cache update-timer 600 Ruijie(config)# snmp-server cache oid 1.3.6.1.4.1.4881.1.1.10.2.56.2.1.1.1</pre> |
| Verification | <ul style="list-style-type: none"> ● Display the configuration information of the device. |

| | |
|--------------|---|
| Agent | <pre>Ruijie# show running-config include snmp snmp-server cache enable snmp-server cache update-timer 600 snmp-server cache oid 1.3.6.1.4.1.4881.1.1.10.2.56.2.1.1.1 snmp-server enable traps snmp-server community public rw</pre> |
|--------------|---|

Common Errors

N/A

5.5 Monitoring

Clearing

| Description | Command |
|---|---|
| Clears the list of source IP addresses that are locked after continuous authentication fails. | clear snmp locked-ip [ipv4 <i>ipv4-address</i> ipv6 <i>ipv6-address</i>] |

Displaying

| Description | Command |
|---------------------------|--|
| Displays the SNMP status. | show snmp [mib user view group host] |

6 Configuring HTTP Service

6.1 Overview

Hypertext Transfer Protocol (HTTP) is used to transmit Web page information on the Internet. It is at the application layer of the TCP/IP protocol stack. The transport layer adopts connection-oriented Transmission Control Protocol (TCP).

Hypertext Transfer Protocol Secure (HTTPS) is an HTTP supporting the Secure Sockets Layer (SSL) protocol. HTTPS is mainly used to create a secure channel on an insecure network, ensure that information can hardly be intercepted, and provide certain reasonable protection against man-in-the-middle attacks. At present, HTTPS is widely used for secure and sensitive communication on the Internet, for example, electronic transactions.

Protocols and Standards

- RFC1945: Hypertext Transfer Protocol -- HTTP/1.0
- RFC2616: Hypertext Transfer Protocol -- HTTP/1.1
- RFC2818: Hypertext Transfer Protocol Over TLS -- HTTPS

6.2 Applications

| Application | Description |
|--|------------------------------------|
| HTTP Application Service | Users manage devices based on Web. |

6.2.1 HTTP Application Service

Scenario

After the HTTP service is enabled, users can access the Web management page after passing authentication by only entering **http://IP address of a device** in the browser of a PC. On the Web page, users you can monitor the device status, configure devices, upload and download files.

Take the following figure as an example to describe Web management.

- Users can remotely access devices on the Internet or configure and manage devices on the Local Area Network (LAN) by logging in to the Web server.
- According to actual conditions, users can choose to enable the HTTPS or HTTP service or enable the HTTPS and HTTP services at the same time.
- Users can also access the HTTP service of devices by setting and using HTTP/1.0 or HTTP/1.1 in the browser.

Figure 6-1

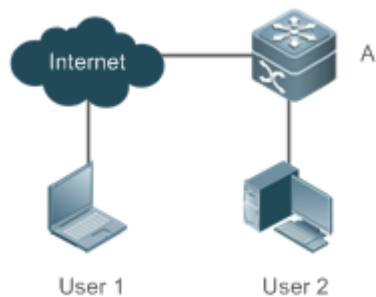

| | |
|----------------|---|
| Remarks | <p>A is a Ruijie device.</p> <p>User 1 accesses the device through the Internet.</p> <p>User 2 accesses the device through a LAN.</p> |
|----------------|---|

Deployment

- When a device runs HTTP, users can access the device by entering **http://IP address of the device** in the browser of a PC.
- When a device runs HTTPS, users can access the device by entering **https://IP address of the device** in the browser of a PC.

6.3 Features

Basic Concepts

HTTP Service

The HTTP service refers to transmission of Web page information on the Internet by using HTTP. HTTP/1.0 is currently an HTTP version that is the most widely used. As one Web server may receive thousands or even millions of access requests, HTTP/1.0 adopts the short connection mode to facilitate connection management. One TCP connection is established for each request. After a request is completed, the TCP connection is released. The server does not need to record or trace previous requests. Although HTTP/1.0 simplifies connection management, HTTP/1.0 introduces performance defects.

For example, a web page may need lots of pictures. However, the web page contains not real picture contents but URL connection addresses of the pictures. In this case, the browser sends multiple requests during access. Each request requires establishing an independent connection and each connection is completely isolated. Establishing and releasing connections is a relatively troublesome process, which severely affects the performance of the client and server, as shown in the following figure:

Figure 6-2

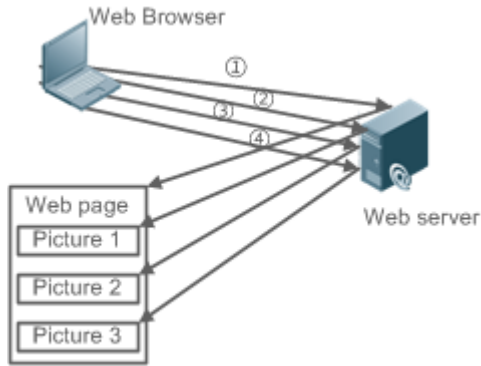

HTTP/1.1 overcomes the defect. It supports persistent connection, that is, one connection can be used to transmit multiple requests and response messages. In this way, a client can send a second request without waiting for completion of the previous request. This reduces network delay and improves performance. See the following figure:

Figure 6-3

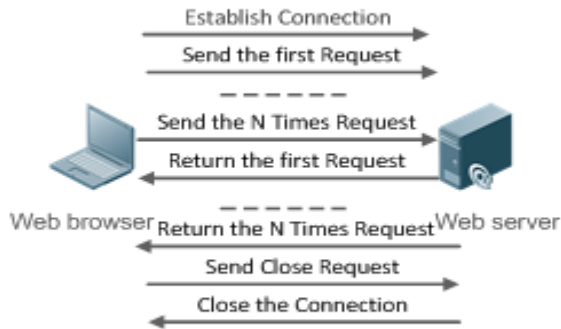

At present, Ruijie devices support both HTTP/1.0 and HTTP/1.1.

i Which HTTP version will be used by a device is decided by the Web browser.

HTTPS Service

The HTTPS service adds the SSL based on the HTTP service. Its security basis is the SSL. To run HTTPS properly, a server must have a Public Key Infrastructure (PKI) certificate while a client may not necessarily need one. The SSL protocol provides the following services:

- Authenticating users and servers and ensuring that data is sent to the correct client and server.
- Encrypting data to prevent data from being stolen midway.
- Maintaining data integrity and ensuring that data is not changed during transmission.

Figure 6-4

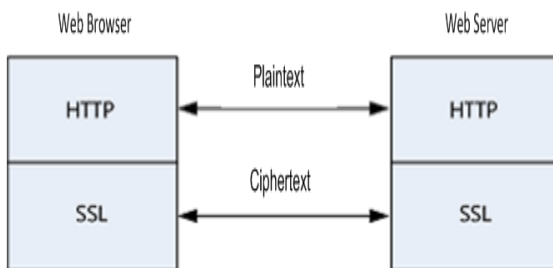

HTTP Upgrade Service

HTTP upgrade includes local HTTP upgrade and remote HTTP upgrade.

- During a local upgrade, a device serves as an HTTP server. Users can log in to the device through a Web browser and upload upgrade files to the device to realize file upgrade on the device.
- During a remote upgrade, a device is connected to a remote HTTP server as a client and realizes local file upgrade by obtaining files from the server.

Features

| Feature | Description |
|--|---|
| HTTP Service | Users log in to devices through Web pages to configure and manage devices. |
| Local HTTP Upgrade Service | Upgrade files are uploaded to a device to realize file upgrade on the device. |

6.3.1 HTTP Service

HTTP is a service provided for Web management. Users log in to devices through Web pages to configure and manage devices.

Working Principle

Web management covers Web clients and Web servers. Similarly, the HTTP service also adopts the client/server mode. The HTTP client is embedded in the Web browser of the Web management client. It can send HTTP packets and receive HTTP response packets. The Web server (namely HTTP server) is embedded in devices. The information exchange between the client and the server is as follows:

- A TCP connection is established between the client and the server. The default port ID of the HTTP service is 80 and the default port ID of the HTTPS service is 443.
- The client sends a request message to the server.
- The server resolves the request message sent by the client. The request content includes obtaining a Web page, executing a CLI command, and uploading a file.

- After executing the request content, the server sends a response message to the client.

Related Configuration

↳ Enabling the HTTP Service

By default, the HTTP service is disabled.

The **enable service web-server** command can be used to enable HTTP service functions, including the HTTP service and HTTPS service.

The HTTP service must be enabled so that users can log in to devices through Web pages to configure and manage devices.

↳ Configuring HTTP Authentication Information

By default, the system creates the **admin** and **guest** account. The accounts cannot be deleted and only the passwords can be changed. The administrator account is the admin account, which corresponds to the level 0 permission. The **guest** account can only view the Web homepage and corresponds to the level 2 permission. The administrator account owns all permissions on the Web client and can edit other management accounts and authorize the accounts to access pages. The new accounts that are added correspond to the level 1 permission.

The **webmaster level** command can be used to configure an authenticated user name and a password.

After this command is run, you need to enter the configured user name and password to log in to the Web page.

↳ Configuring an HTTP Service Port

By default, the HTTP service port ID is 80.

The **http port** command can be used to configure an HTTP service port ID. The value range of the port ID is 80 and 1025 to 65535.

By configuring an HTTP service port ID, you can reduce the number of attacks initiated by illegal users on the HTTP service.

↳ Configuring an HTTPS Service Port

By default, the HTTPS service port ID is 443.

The **http secure-port** command can be used to configure an HTTPS service port ID. The value range of the port ID is 443 and 1025 to 65535.

By configuring an HTTPS service port ID, you can reduce the number of attacks initiated by illegal users on the HTTPS service.

6.3.2 Local HTTP Upgrade Service

When a device serves as the HTTP server, users can log in to the device through a Web browser and upload upgrade files (including component package and Web package) to the device or directly upload files to the device through Trivial File Transfer Protocol (TFTP).

Working Principle

- A component package or Web package is uploaded through the local upgrade function provided by Web.

- After successfully receiving a file, the device checks the version for its validity.
- After the file check is successful, if the file is a Web package, perform the upgrade directly; if the file is a component package, decide whether to perform the upgrade in the browser by restarting the device.

Related Configuration

↳ **Updating a Web Package**

Run the **upgrade web download** command to download a Web package from the TFTP server.

After the command is run, download a Web package from the TFTP server. After the package passes the validity check, directly use the Web package for upgrade without restarting the device.



You can also run the **upgrade web** command to directly upgrade a Web package stored locally.

↳ **Updating a Subsystem Component**

By default, a device does not upgrade subsystem components uploaded through a browser or TFTP.

To upgrade a subsystem component, you must restart the device.

6.4 Configuration

| Configuration | Description and Command | |
|--|---|---|
| Configuring the HTTP Service |  (Mandatory) It is used to enable the HTTP service. | |
| | enable service web-server | Enables the HTTP service. |
| | webmaster level | Configures HTTP authentication information. |
| | http port | Configures an HTTP service port. |
| | http secure-port | Configures an HTTPS service port. |
| Configuring a Local HTTP Upgrade |  (Mandatory) It is used to realize a local HTTP upgrade. | |
| | upgrade web | Upgrades a Web package stored on a device. |
| | upgrade web download | Automatically downloads a Web package from a server and automatically upgrades the package. |

6.4.1 Configuring the HTTP Service

Configuration Effect

After the HTTP service is enabled on a device, users can log in to the Web management page after passing authentication and monitor the device status, configure devices, upload and download files.

Configuration Steps

▾ Enabling the HTTP Service

- Mandatory
- If there is no special requirement, enable the HTTP service on Ruijie devices. Otherwise, the Web service is inaccessible.

▾ Configuring HTTP Authentication Information

- By default, the user name **admin** and **guest** and the password **admin** and **guest** are configured.
- If there is no special requirement, you can log in to the Web page by using the default user name and directly update authentication information through the Web browser. If you always use the default account, security risks may exist because unauthorized personnel can obtain device configuration information once the IP address is disclosed.

▾ Configuring an HTTP Service Port

- If an HTTP service port needs to be changed, the HTTP service port must be configured.
- If there is no special requirement, the default HTTP service port 80 can be used for access.

▾ Configuring an HTTPS Service Port

- If an HTTPS service port needs to be changed, the HTTPS service port must be configured.
- If there is no special requirement, the default HTTPS service port 443 can be used for access.

Verification



- Enter **http://IP address of the device: service port** to check whether the browser skips to the authentication page.
- Enter **https://IP address of the device: service port** to check whether the browser skips to the authentication page.

Related Commands

▾ Enabling the HTTP Service

| | |
|------------------------------|--|
| Command | enable service web-server [http https all] |
| Parameter Description | http https all : Enables the corresponding service. http indicates enabling the HTTP service, https indicates enabling the HTTPS service, and all indicates enabling the HTTP and HTTPS services at the same time. By default, the HTTP and HTTPS services are enabled at the same time. |
| Command Mode | Global configuration mode. |
| Usage Guide | If no key word or all is put at the end of the command when the command is run, the HTTP and HTTPS services are enabled at the same time. If the key word http is put at the end of the command, only the HTTP service is enabled; if the key word https is put at the end of the command, only the HTTPS service is enabled. The no enable service web-server or default enable service web-server command is used to disable the corresponding HTTP service. If no key word is put at the end of the no enable service web-server or default enable service web-server command, the HTTP and HTTPS services are disabled. |

▾ Configuring HTTP Authentication Information.

| | |
|------------------------------|---|
| Command | webmaster level <i>privilege-level</i> username <i>name</i> password { <i>password</i> [0 7] <i>encrypted-password</i> } |
| Parameter Description | <p><i>privilege-level</i>: Permission level bound to a user.</p> <p><i>name</i>: User name.</p> <p><i>password</i>: User password.</p> <p>0 7: Password encryption type. 0: no encryption; 7: simple encryption. The default value is 0.</p> <p><i>encrypted-password</i>: Password text.</p> |
| Command Mode | Global configuration mode. |
| Usage Guide | <p>When the HTTP server is used, you need to be authenticated before logging in to the Web page. The webmaster level command is used to configure a user name and a password for logging in to the Web page. Run the no webmaster level <i>privilege-level</i> command to delete all user names and passwords of the specified permission level.</p> <p>Run the no webmaster level <i>privilege-level</i> username <i>name</i> command to delete the specified user name and password.</p> <hr/> <p> User names and passwords involve three permission levels: Up to 10 user names and passwords can be configured for each permission level.</p> <p> By default, the system creates the admin account. The account cannot be deleted and only the password of the account can be changed. The administrator account is the admin account, which corresponds to the level 0 permission. The administrator account owns all permissions on the Web client and can edit other management accounts and authorize the accounts to access pages. The new accounts that are added correspond to the level 1 permission.</p> |

↘ Configuring an HTTP Service Port

| | |
|------------------------------|--|
| Command | http port <i>port-number</i> |
| Parameter Description | <i>port-number</i> : Configures an HTTP service port. The value range is 80 and 1025 to 65535. |
| Command Mode | Global configuration mode. |
| Usage Guide | Run the command to set an HTTP service port. |

↘ Configuring an HTTPS Service Port

| | |
|------------------------------|--|
| Command | http secure-port <i>port-number</i> |
| Parameter Description | <i>port-number</i> : Configures an HTTPS service port. The value range is 443 and 1025 to 65535. |
| Command Mode | Global configuration mode. |
| Usage Guide | Run the command to set an HTTPS service port. |

Configuration Example

Managing one Ruijie Device by Using Web and Logging in to the Device through a Web Browser to Configure Related Functions

- Log in to the device by using the **admin** account configured by default.
- To improve security, the Web browser is required to support both HTTP and HTTPS for access.
- The user is required to configure an HTTP service port to reduce the number of attacks initiated by illegal users on HTTP.

| | |
|--------------------------------------|---|
| Scenario Figure 6-5 |  |
| Configuration Steps | <ul style="list-style-type: none"> ● Enable the HTTP and HTTPS services at the same time. ● Set the HTTP service port ID to 8080 and the HTTPS service port ID to 4430. |
| A | <pre>A#configure terminal A(config)# enable service web-server A(config)# http port 8080 A(config)# http secure-port 4430</pre> |
| Verification | Check HTTP configurations. |
| A | <pre>A# show web-server status http server status: enabled http server port: 8080 https server status:enabled https server port: 4430</pre> |

Common Errors

- If the HTTP service port is not the default port 80 or 443, you must enter a specific configured service port in the browser. Otherwise, you cannot access devices on the Web client.

6.4.2 Configuring a Local HTTP Upgrade

Configuration Effect

Perform an HTTP upgrade through the browser or the **upgrade web** command.

Notes

- So long as a Web package is uploaded successfully and passes the version check, the device directly performs an upgrade based on the latest Web package.

- The **upgrade web download** command is used to automatically download files from the TFTP server and automatically perform an upgrade.
- The **upgrade web** command is used to automatically upgrade the Web package in the local file system.

Configuration Steps

N/A

Verification

- Access and view the latest Web page through the browser.

Related Commands

Downloading a Web Package from the TFTP Server

| | |
|------------------------------|---|
| Command | upgrade web download tftp: /path |
| Parameter Description | <i>tftp</i> : Connects the FTFP server through a common data port and downloads a Web package. <i>path</i> : Path of a Web package on the TFTP server. |
| Command Mode | Privileged EXEC mode |
| Usage Guide | This command is used to download a Web package from the TFTP server and automatically perform an upgrade. |

Upgrading a Web Package Stored on a Local Device

| | |
|------------------------------|--|
| Command | upgrade web <i>uri</i> |
| Parameter Description | <i>uri</i> : Local path for storing a Web package. |
| Command Mode | Privileged EXEC mode |
| Usage Guide | This command is used to upgrade a Web package stored on a device and automatically perform an upgrade. |

Configuration Example

Obtaining the Latest Web Package from the Official Website and Running the Web Package

| | |
|-------------------------------|---|
| Scenario Figure 6-6 |  <p>The diagram shows a network device (represented by a blue cube with a cross) labeled 'A' connected via a line to a laptop labeled 'Web browser'.</p> |
| Configuration Steps | <ul style="list-style-type: none"> ● Connect to a local PC whose IP address is 10.10.10.13 and assign an IP address 10.10.10.131 in the same network segment to the device. ● Log in to the device through Web and upload the latest Web package to the device. |
| A | <code>A#configure terminal</code> |

| | |
|---------------------|---|
| | <pre>A(config)# vlan 1 A(config-vlan)# exit A(config)# interface vlan 1 A(config-VLAN 1)# ip address 10.10.10.131 255.255.255.0 A(config-VLAN 1)# exit A(config)# enable service web-server</pre> |
| | On a PC, use the local upgrade function on the Web page to upload a Web package for upgrade. |
| Verification | On the PC, log in to the device through Web again and check whether the latest Web page is displayed. |

↘ **Upgrading a Web Package by Running the upgrade web download Command**

| | |
|-------------------------------|--|
| Scenario Figure 6-7 |  |
| Configuration Steps | <ul style="list-style-type: none"> ● Connect to a local PC whose IP address is 10.10.10.13 and assign an IP address 10.10.10.131 in the same network segment to the device. ● Start the TFTP server. |
| A | <pre>A#configure terminal A(config)# vlan 1 A(config-vlan)# exit A(config)# interface vlan 1 A(config-VLAN 1)# ip address 10.10.10.131 255.255.255.0 A(config-VLAN 1)# end A#upgrade web download tftp:// 10.10.10.13/web.upd Press Ctrl+C to quit !!!!!!!!!! download 3896704 bytes Begin to upgrade the web package... Web package upgrade successfully.</pre> |
| Verification | On the PC, log in to the device through Web again and check whether the latest Web page is displayed. |

↘ **Upgrading a Web Package by Running the upgrade web Command**

| | |
|---------------------------------------|---|
| <p>Scenario Figure 6-8</p> |  |
| <p>Configuration Steps</p> | <ul style="list-style-type: none"> ● Connect to a local PC whose IP address is 10.10.10.13 and assign an IP address 10.10.10.131 in the same network segment to the device. ● Start the TFTP server. |
| <p>A</p> | <pre> A#configure terminal A(config)# vlan 1 A(config-vlan)# exit A(config)# interface vlan 1 A(config-VLAN 1)# ip address 10.10.10.131 255.255.255.0 A(config-VLAN 1)# end A#copy tftp://10.10.10.13/web.upd flash:/web.upd Press Ctrl+C to quit !!!!!!!! Accessing tftp:// 10.10.10.13/web.upd finished, 3896704 bytes prepared Flushing data to flash:/web.upd... Flush data done A #upgrade web flash:/web.upd Web package upgrade successfully. A # </pre> |
| <p>Verification</p> | <p>On the PC, log in to the device through Web again and check whether the latest Web page is displayed.</p> |

Common Errors

- Access to the web page through the browser shows that the web page is not updated based on the latest Web package. This is possibly because the local browser has a cache. Clear the cache of the local browser and access the Web page again.

6.5 Monitoring

Displaying

| Description | Command |
|-------------|---------|
|-------------|---------|

Displays the configuration and status of the Web service.

show web-server status

7 Configuring Syslog

7.1 Overview

Status changes (such as link up and down) or abnormal events may occur anytime. Ruijie products provide the syslog mechanism to automatically generate messages (log packets) in fixed format upon status changes or occurrence of events. These messages are displayed on the related windows such as the Console or monitoring terminal, recorded on media such as the memory buffer or log files, or sent to a group of log servers on the network so that the administrator can analyze network performance and identify faults based on these log packets. Log packets can be added with the timestamps and sequence numbers and classified by severity level so that the administrator can conveniently read and manage log packets.

Protocols and Standards

- RFC3164: The BSD syslog Protocol
- RFC5424: The_Syslog_Protocol

7.2 Applications

| Application | Description |
|---|--------------------------------------|
| Sending Syslogs to the Console | Monitor syslogs through the Console. |
| Sending Syslogs to the Log Server | Monitor syslogs through the server. |

7.2.1 Sending Syslogs to the Console

Scenario

Send syslogs to the Console to facilitate the administrator to monitor the performance of the system. The requirements are as follows:

1. Send logs of Level 6 or higher to the Console.
2. Send logs of only the ARP and IP modules to the Console.

Figure 7-1 shows the network topology.

Figure 7-1 Network topology

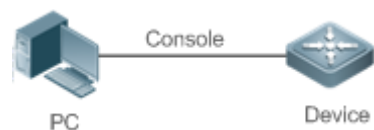

Deployment

Configure the device as follows:

1. Set the level of logs that can be sent to the Console to informational (Level 6).
2. Set the filtering direction of logs to terminal.
3. Set log filtering mode of logs to contains-only.
4. Set the filtering rule of logs to single-match. The module name contains only ARP or IP.

7.2.2 Sending Syslogs to the Log Server

Scenario

Send syslogs to the log server to facilitate the administrator to monitor the logs of devices on the server. The requirements are as follows:

1. Send syslogs to the log server 10.1.1.1.
2. Send logs of Level 7 or higher to the log server.
3. Send syslogs from the source interface Loopback 0 to the log server.

Figure 7-2 shows the network topology.

Figure 7-2 Network topology



Deployment

Configure the device as follows:

1. Set the IPv4 address of the server to 10.1.1.1.
2. Set the level of logs that can be sent to the log server to debugging (Level 7).
3. Set the source interface of logs sent to the log server to Loopback 0.

7.3 Features

Basic Concepts

↘ Classification of Syslogs

Syslogs can be classified into two types:

- Log type
- Debug type

↘ Levels of Syslogs

Eight severity levels of syslogs are defined in descending order, including emergency, alert, critical, error, warning, notification, informational, and debugging. These levels correspond to eight numerical values from 0 to 7. A smaller value indicates a higher level.

Only logs with a level equaling to or higher than the specified level can be output. For example, if the level of logs is set to informational (Level 6), logs of Level 6 or higher will be output.

The following table describes the log levels.

| Level | Numerical Value | Description |
|---------------|-----------------|---|
| emergencies | 0 | Indicates that the system cannot run normally. |
| alerts | 1 | Indicates that the measures must be taken immediately. |
| critical | 2 | Indicates a critical condition. |
| errors | 3 | Indicates an error. |
| warnings | 4 | Indicates a warning. |
| notifications | 5 | Indicates a notification message that requires attention. |
| informational | 6 | Indicates an informational message. |
| debugging | 7 | Indicates a debugging message. |

↘ Output Direction of Syslogs

Output directions of syslogs include Console, monitor, server, buffer, and file. The default level and type of logs vary with the output direction. You can customize filtering rules for different output directions.

The following table describes output directions of syslogs.

| Output Direction | Description | Default Output Level | Description |
|------------------|---------------------|-------------------------|--|
| Console | Console | Debugging (Level 7) | Logs and debugging information are output. |
| monitor | Monitoring terminal | Debugging (Level 7) | Logs and debugging information are output. |
| server | Log server | Informational (Level 6) | Logs and debugging information are output. |
| buffer | Log buffer | Debugging (Level 7) | Logs and debugging information are output. The log buffer is used to store syslogs. |
| file | Log file | Informational (Level 6) | Logs and debugging information are output. Logs in the log buffer are periodically written into files. |

↘ RFC3164 Log Format

Formats of syslogs may vary with the syslog output direction.

- If the output direction is the Console, monitor, buffer, or file, the syslog format is as follows:

```
seq no: *timestamp: sysname %module-level-mnemonic: content
```

For example, if you exit configuration mode, the following log is displayed on the Console:

```
001233: *May 22 09:44:36: Ruijie %SYS-5-CONFIG_I: Configured from console by console
```

- If the output direction is the log server, the syslog format is as follows:

```
<priority>seq no: *timestamp: sysname %module-level-mnemonic: content
```

For example, if you exit configuration mode, the following log is displayed on the log server:

```
<189>001233: *May 22 09:44:36: Ruijie %SYS-5-CONFIG_I: Configured from console by console
```

The following describes each field in the log in details:

7. Priority

This field is valid only when logs are sent to the log server.

The priority is calculated using the following formula: Facility x 8 + Level. Level indicates the numerical code of the log level and Facility indicates the numerical code of the facility. The default facility value is local7 (23). The following table lists the value range of the facility.

| Numerical Code | Facility Keyword | Facility Description |
|----------------|------------------|--|
| 0 | kern | kernel messages |
| 1 | user | user-level messages |
| 2 | mail | mail system |
| 3 | daemon | system daemons |
| 4 | auth1 | security/authorization messages |
| 5 | syslog | messages generated internally by syslogs |
| 6 | lpr | line printer subsystem |
| 7 | news | network news subsystem |
| 8 | uucp | UUCP subsystem |
| 9 | clock1 | clock daemon |
| 10 | auth2 | security/authorization messages |
| 11 | ftp | FTP daemon |
| 12 | ntp | NTP subsystem |
| 13 | logaudit | log audit |
| 14 | logalert | log alert |
| 15 | clock2 | clock daemon |
| 16 | local0 | local use 0 (local0) |
| 17 | local1 | local use 1 (local1) |
| 18 | local2 | local use 2 (local2) |
| 19 | local3 | local use 3 (local3) |
| 20 | local4 | local use 4 (local4) |
| 21 | local5 | local use 5 (local5) |
| 22 | local6 | local use 6 (local6) |
| 23 | local7 | local use 7 (local7) |

8. Sequence Number

The sequence number of a syslog is a 6-digit integer, and increases sequentially. By default, the sequence number is not displayed. You can run a command to display or hide this field.

9. Timestamp

The timestamp records the time when a syslog is generated so that you can display and check the system event conveniently. Ruijie devices support two syslog timestamp formats: datetime and uptime.

- i If the device does not have the real time clock (RTC), which is used to record the system absolute time, the device uses its startup time (uptime) as the syslog timestamp by default. If the device has the RTC, the device uses its absolute time (datetime) as the syslog timestamp by default.

The two timestamp formats are described as follows:

- Datetime format

The datetime format is as follows:

```
Mmm dd yyyy hh:mm:ss.msec
```

The following table describes each parameter of the datetime.

| Timestamp Parameter | Parameter Name | Description |
|---------------------|----------------|---|
| Mmm | Month | Mmm refers to abbreviation of the current month. The 12 months in a year are written as Jan, Feb, Mar, Apr, May, Jun, Jul, Aug, Sep, Oct, Nov, and Dec. |
| dd | Day | dd indicates the current date. |
| yyyy | Year | yyyy indicates the current year, and is not displayed by default. |
| hh | Hour | hh indicates the current hour. |
| mm | Minute | mm indicates the current minute. |
| ss | Second | ss indicates the current second. |
| msec | Millisecond | msec indicates the current millisecond. |

By default, the datetime timestamp displayed in the syslog does not contain the year and millisecond. You can run a command to display or hide the year and millisecond of the datetime timestamp.

- Uptime format

The uptime format is as follows:

```
dd:hh:mm:ss
```

The timestamp string indicates the accumulated days, hours, minutes, and seconds since the system is started.

10. Sysname

This field indicates the name of the device that generates the log so that the log server can identify the host that sends the log. By default, this field is not displayed. You can run a command to display or hide this field.

11. Module

This field indicates the name of the module that generates the log. The module name is an upper-case string of 2 to 20 characters, which contain upper-case letters, digits, or underscores. The module field is mandatory in the log-type information, and optional in the debug-type information.

12. Level

Eight syslog levels from 0 to 7 are defined. The level of syslogs generated by each module is fixed and cannot be modified.

13. Mnemonic

This field indicates the brief information about the log. The mnemonic is an upper-case string of 4 to 32 characters, which may include upper-case letters, digits, or underscore. The mnemonic field is mandatory in the log-type information, and optional in the debug-type information.

14. Content

This field indicates the detailed content of the syslog.

↘ **RFC5424 Log Format**

The syslog format in the output direction is as follows:

```
<priority>version timestamp sysname MODULE LEVEL MNEMONIC [structured-data] description
```

For example, if you exit configuration mode, the following log is displayed on the Console:

```
<133>1 2013-07-24T12:19:33.130290Z ruijie SYS 5 CONFIG - Configured from console by console
```

The following describes each field in the log in details:

15. Priority

The priority is calculated using the following formula: Facility x 8 + Level. Level indicates the numerical code of the log level and Facility indicates the numerical code of the facility. When the RFC5424 format is enabled, the default value of the facility field is local0 (16).

16. Version

According to RFC5424, the version is always 1.

17. Timestamp

The timestamp records the time when a syslog is generated so that you can display and check the system event conveniently. Ruijie devices use the following uniformed timestamp format when the RFC5424 logging function is enabled:

```
YYYY-MM-DDTHH:MM:SS.SSECFRACZ
```

The following table describes each parameter of the timestamp.

| Timestamp Parameter | Description | Remark |
|---------------------|-------------|----------------------------------|
| YYYY | Year | YYYY indicates the current year. |
| MM | Month | MM indicates the current month. |
| DD | Day | DD indicates the current date. |
| T | Separator | The date must end with "T". |
| HH | Hour | HH indicates the current hour. |

| | | |
|---------|-------------|---|
| MM | Minute | MM indicates the current minute. |
| SS | Second | SS indicates the current second. |
| SECFRAC | Millisecond | SECFRAC indicates the current millisecond (1–6 digits). |
| Z | End mark | The time must end with "Z". |

18. Sysname

This field indicates the name of the device that generates the log so that the log server can identify the host that sends the log.

19. Module

This field indicates the name of the module that generates the log. The module name is an upper-case string of 2 to 20 characters, which contain upper-case letters, digits, or underscores. The module field is mandatory in the log-type information, and optional in the debug-type information.

20. Level

Eight syslog levels from 0 to 7 are defined. The level of syslogs generated by each module is fixed and cannot be modified.

21. Mnemonic

This field indicates the brief information about the log. The mnemonic is an upper-case string of 4 to 32 characters, which contain upper-case letters, digits, or underscores. The Mnemonic field is mandatory in the log-type information, and optional in the debug-type information.

22. Structured-Data

Structured-data introduced in RFC5424 is parsed as a whole string containing parameter information. Each log may contain 0 or multiple parameters. If a parameter is null, replace this parameter with a placeholder (-). The format of this field is as follows:

```
[SD_ID@enterpriseID PARAM-NAME=PARAM-VALUE]
```

The following table describes each parameter of the structured-data field.

| Parameter in structured-data | Description | Remarks |
|------------------------------|----------------------------|--|
| SD_ID | Parameter information name | The parameter information name is capitalized, and must be unique in a log. |
| @ | Separator | "@enterpriseID" is added only to the customized parameter information, not to the parameter information defined in RFC5424. |
| enterpriseID | Enterprise ID | The enterprise ID is maintained by the Internet Assigned Numbers Authority (IANA). Ruijie Networks' enterprise ID is 4881. You can query the enterprise ID on the official website of IANA. http://www.iana.org/assignments/enterprise-numbers |
| PARAM-NAME | Parameter name | The parameter name is capitalized, and must be unique in the structured-data of a log. |

| Parameter in structured-data | Description | Remarks |
|------------------------------|-----------------|---|
| PARAM-VALUE | Parameter value | The parameter value must be enclosed in double quotation marks. Values of the IP address or MAC address must be capitalized, and other types of values are capitalized as required. |

23. description

This field indicates the content of the syslog.

Overview

| Feature | Description |
|-----------------------------------|---|
| Logging | Enable or disable the system logging functions. |
| Syslog Format | Configure the syslog format. |
| Logging Direction | Configure the parameters to send syslogs in different directions. |
| Syslog Filtering | Configure parameters of the syslog filtering function. |
| Featured Logging | Configure parameters of the featured logging function. |
| Syslog Monitoring | Configure parameters of the syslog monitoring function. |

7.3.1 Logging

Enable or disable the logging, log statistics functions.

Related Configuration

↘ Enable Logging

By default, logging is enabled.

Run the **logging on** command to enable logging in global configuration mode. After logging is enabled, logs generated by the system are sent in various directions for the administrator to monitor the performance of the system.

↘ Enabling Log Statistics

By default, log statistics is disabled.

Run the **logging count** command to enable log statistics in global configuration mode. After log statistics is enabled, the system records the number of times a log is generated and the last time when the log is generated.

7.3.2 Syslog Format

Configure the syslog format, including the RFC5424 log format, timestamp format, sysname, and sequence number.

Related Configuration

↘ Enabling the RFC5424 Log Format

By default, the RFC5424 log format is disabled.

After the new format (RFC5424 log format) is enabled, the **service sequence-numbers**, **service sysname**, **service timestamps**, **service private-syslog**, and **service standard-syslog** that are applicable only to the old format (RFC3164 log format) lose effect and are hidden.

After the old format (RFC3164 log format) is enabled, the **logging delay-send**, **logging policy**, and **logging statistic** commands that are applicable only to the RFC5424 log format lose effect and are hidden.

After log format switchover, the outputs of the **show logging** and **show logging config** commands change accordingly.

↘ Configuring the Timestamp Format

By default, the syslog uses the datetime timestamp format, and the timestamp does not contain the year and millisecond.

Run the **service timestamps** command in global configuration mode to use the datetime timestamp format that contains the year and millisecond in the syslog, or change the datetime format to the uptime format.

↘ Adding Sysname to the Syslog

By default, the syslog does not contain sysname.

Run the **service sysname** command in global configuration mode to add sysname to the syslog.

↘ Adding the Sequence Number to the Syslog

By default, the syslog does not contain the sequence number.

Run the **service sequence-numbers** command in global configuration mode to add the sequence number to the syslog.

↘ Enabling the Standard Log Format

By default, logs are displayed in the following format:

```
*timestamp: %module-level-mnemonic: content
```

Run the **service standard-syslog** command in global configuration mode to enable the standard log format and logs are displayed in the following format:

```
timestamp %module-level-mnemonic: content
```

Compared with the default log format, an asterisk (*) is missing in front of the timestamp, and a colon (:) is missing at the end of the timestamp in the standard log format.

↘ Enabling the Private Log Format

By default, logs are displayed in the following format:

```
*timestamp: %module-level-mnemonic: content
```

Run the **service private-syslog** command in global configuration mode to enable the private log format and logs are displayed in the following format:

```
timestamp module-level-mnemonic: content
```

Compared with the default log format, an asterisk (*) is missing in front of the timestamp, a colon (:) is missing at the end of the timestamp, and a percent sign (%) is missing at the end of the module name in the private log format.

7.3.3 Logging Direction

Configure parameters for sending syslogs in different directions, including the Console, monitor terminal, buffer, the log server, and log files.

Related Configuration

↘ Configuring the Log Rate Limit

By default, no log rate limit is configured.

Run the **logging rate-limit** { *number* | **all** *number* | **console** {*number* | **all** *number* } } [**except** [*severity*]] command in global configuration mode to configure the log rate limit.

↘ Configuring the Level of Logs Sent to the Console

By default, the level of logs sent to the Console is debugging (Level 7).

Run the **logging console** [*level*] command in global configuration mode to configure the level of logs that can be sent to the Console.

↘ Sending Logs to the Monitor Terminal

By default, it is not allowed to send logs to the monitor terminal.

Run the **terminal monitor** command in the privileged EXEC mode to send logs to the monitor terminal.

↘ Configuring the Level of Logs Sent to the Monitor Terminal

By default, the level of logs sent to the monitor terminal is debugging (Level 7).

Run the **logging monitor** [*level*] command in global configuration mode to configure the level of logs that can be sent to the monitor terminal.

↘ Writing Logs into the Memory Buffer

By default, logs are written into the memory buffer, and the default level of logs is debugging (Level 7).

Run the **logging buffered** [*buffer-size*] [*level*] command in global configuration mode to configure parameters for writing logs into the memory buffer, including the buffer size and log level.

↘ Sending Logs to the Log Server

By default, logs are not sent to the log server.

Run the **logging server** { *ip-address* | **ipv6** *ipv6-address* } [**udp-port** *port*] command in global configuration mode to send logs to a specified log server.

↘ Configuring the Level of Logs Sent to the Log Server

By default, the level of logs sent to the log server is informational (Level 6).

Run the **logging trap** [*level*] command in global configuration mode to configure the level of logs that can be sent to the log server.

✚ Configuring the Facility Value of Logs Sent to the Log Server

If the RFC5424 log format is disabled, the facility value of logs sent to the log server is local7 (23) by default. If the RFC5424 log format is enabled, the facility value of logs sent to the log server is local0 (16) by default.

Run the **logging facility** *facility-type* command in global configuration mode to configure the facility value of logs sent to the log server.

✚ Configuring the Source Address of Logs Sent to the Log Server

By default, the source address of logs sent to the log server is the IP address of the interface sending logs.

Run the **logging source** [**interface**] *interface-type interface-number* command to configure the source interface of logs. If this source interface is not configured, or the IP address is not configured for this source interface, the source address of logs is the IP address of the interface sending logs.

Run the **logging source** { **ip** *ip-address* | **ipv6** *ipv6-address* } command to configure the source IP address of logs. If this IP address is not configured on the device, the source address of logs is the IP address of the interface sending logs.

✚ Writing Logs into Log Files

By default, logs are not written into log files. After the function of writing logs into log files is enabled, the level of logs written into log files is informational (Level 6) by default.

Run the **logging file flash:filename** [*max-file-size*] [*level*] command in global configuration mode to configure parameters for writing logs into log files, including the type of device where the file is stored, file name, file size, and log level.

✚ Configuring the Interval at Which Logs Are Written into Log Files

By default, logs are written into log files at the interval of 3600s (one hour).

Run the **logging flash interval** *seconds* command in global configuration mode to configure the interval at which logs are written into log files.

✚ Configuring the Storage Time of Log Files

By default, the storage time is not configured.

Run the **logging life-time level** *level days* command in global configuration mode to configure the storage time of logs. The administrator can specify different storage days for logs of different levels.

✚ Immediately Writing Logs in the Buffer into Log Files

By default, syslogs are stored in the syslog buffer and then written into log files periodically or when the buffer is full.

Run the **logging flash flush** command in global configuration mode to immediately write logs in the buffer into log files so that you can collect logs conveniently.

7.3.4 Syslog Filtering

By default, logs generated by the system are sent in all directions.

Working Principle

↘ Filtering Direction

Five log filtering directions are defined:

- **buffer**: Filters out logs sent to the log buffer, that is, logs displayed by the **show logging** command.
- **file**: Filters out logs written into log files.
- **server**: Filters out logs sent to the log server.
- **terminal**: Filters out logs sent to the Console and monitor terminal (including Telnet and SSH).

The four filtering directions can be used either in combinations to filter out logs sent in various directions, or separately to filter out logs sent in a single direction.

↘ Filtering Mode

Two filtering modes are available:

- **contains-only**: Indicates that only logs that contain keywords specified in the filtering rules are output. You may be interested in only a specified type of logs. In this case, you can apply the contains-only mode on the device to display only logs that match filtering rules on the terminal, helping you check whether any event occurs.
- **filter-only**: Indicates that logs that contain keywords specified in the filtering rules are filtered out and will not be output. If a module generates too many logs, spamming may occur on the terminal interface. If you do not care about this type of logs, you can apply the filter-only mode and configure related filtering rules to filter out logs that may cause spamming.

The two filtering modes are mutually exclusive, that is, you can configure only one filtering mode at a time.

↘ Filter Rule

Two filtering rules are available:

- **exact-match**: If exact-match is selected, you must select all the three filtering options (module, level, and mnemonic). If you want to filter out a specified log, use the exact-match filtering rule.
- **single-match**: If exact-match is selected, you only need to select one of the three filtering options (module, level, and mnemonic). If you want to filter out a specified type of logs, use the single-match filtering rule.

If the same module, level, or mnemonic is configured in both the single-match and exact-match rules, the single-match rule prevails over the exact-match rule.

Related Configuration

↘ Configuring the Log Filtering Direction

By default, the log filtering direction is all, that is, logs sent in all directions are filtered.

Run the **logging filter direction { all | buffer | file | server | terminal }** command in global configuration mode to configure the log filtering direction to filter out logs in the specified directions.

↘ Configuring the Log Filtering Mode

By default, the log filtering mode is filter-only.

Run the **logging filter type** { **contains-only** | **filter-only** } command in global configuration mode to configure the log filtering mode.

📌 Configuring the Log Filtering Rule

By default, no log filtering rule is configured on a device, that is, logs are not filtered out.

Run the **logging filter rule exact-match module** *module-name mnemonic mnemonic-name level level* command in global configuration mode to configure the exact-match rule.

Run the **logging filter rule single-match** { **level** *level* | **mnemonic** *mnemonic-name* | **module** *module-name* } command in global configuration mode to configure the single-match rule.

7.3.5 Featured Logging

The featured logging functions include level-based logging, delayed logging, and periodical logging. If the RFC5424 log format is enabled, logs can be sent in all directions, delayed logging is enabled, and periodical logging is disabled by default. If the RFC5424 log format is disabled, level-based logging, delayed logging, and periodical logging are disabled.

Working Principle

📌 Level-based Logging

You can use the level-based logging function to send syslogs to different destinations based on different module and severity level. For example, you can configure commands to send WLAN module logs of Level 4 or lower to the log server, and WLAN module logs of Level 5 or higher to local log files.

📌 Delayed Logging

After generated, logs are not directly sent to the log server, and instead they are buffered in the log file. The device sends the log file to the syslog server through FTP at a certain interval. This function is called delayed logging.

If the device generates too many logs, sending all logs to the server in real time may deteriorate the performance of the device and the syslog server, and increase the burden of the network. In this case, the delayed logging function can be used to reduce the packet interaction.

By default, the log file sent to the remote server is named **File size_Device IP address_Index.txt**. If the prefix of the log file name is modified, the log file sent to the remote server is named **Configured file name prefix_File size_Device IP address_Index.txt**. The file stored on the local Flash of the device is named **Configured file name prefix_Index.txt**. By default, the file name prefix is `syslog_ftp_server`, the delayed logging interval is 3600s (one hour), and the log file size is 128 KB.

The maximum value of the delayed logging interval is 65535s, that is, 18 hours. If you set the delayed logging interval to the maximum value, the amount of logs generated in this period may exceed the file size (128 KB). To prevent loss of logs, logs will be written into a new log file, and the index increases by 1. When the timer expires, all log files buffered in this period will be sent to the FTP or TFTP server at a time.

The Flash on the device that is used to buffer the local log files is limited in size. A maximum of eight log files can be buffered on the device. If the number of local log files exceeds eight before the timer expires, all log files that are generated earlier will be sent to the FTP or TFTP server at a time.

↘ Periodical Logging

Logs about performance statistics are periodically sent. All periodical logging timers are managed by the syslog module. When the timer expires, the syslog module calls the log processing function registered with each module to output the performance statistic logs and send logs in real time to the remote syslog server. The server analyzes these logs to evaluate the device performance.

By default, the periodical logging interval is 15 minutes. To enable the server to collect all performance statistic logs at a time, you need to set the log periodical logging intervals of different statistic objects to a common multiple of them. Currently, the interval can be set to 0, 15, 30, 60, or 120. 0 indicates that periodical logging is disabled.

Related Configuration

↘ Configuring the Level-based Logging Policy

By default, device logs are sent in all directions.

Run the **logging policy module** *module-name* [**not-lesser-than**] *level* **direction** { **all** | **server** | **file** | **console** | **monitor** | **buffer** } command in global configuration mode to configure the level-based logging policy.

↘ Enabling Delayed Display of Logs on the Console and Remote Terminal

By default, delayed display of logs on the Console and remote terminal is disabled.

Run the **logging delay-send terminal** command in global configuration mode to enable delayed display of logs on the Console and remote terminal.

↘ Configuring the Name of the File for Delayed Logging

By default, the log file sent to the remote server is named **File size_Device IP address_Index.txt**. If the prefix of the log file name is modified, the log file sent to the remote server is named **Configured file name prefix_File size_Device IP address_Index.txt**. The file stored on the local Flash of the device is named **Configured file name prefix_Index.txt**. The default file name prefix is `syslog_ftp_server`.

Run the **logging delay-send file flash:filename** command in global configuration mode to configure the name of the log file that is buffered on the local device.

↘ Configuring the Delayed Logging Interval

By default, the delayed logging interval is 3600s (one hour).

Run the **logging delay-send interval seconds** command in global configuration mode to configure the delayed logging interval.

↘ Configuring the Server Address and Delayed Logging Mode

By default, logs are not sent to any FTP or TFTP server.

Run the **logging delay-send server** *{ip-address | ipv6 ipv6-address}mode {ftp user username password [0 | 7] password | tftp}* command in global configuration mode to configure the server address and delayed logging mode.

↘ Enabling Periodical Logging

By default, periodical logging is disabled.

Run the **logging statistic enable** command in global configuration mode to enable periodical uploading of logs. After this function is enabled, the system outputs a series of performance statistics at a certain interval so that the log server can monitor the system performance.

↘ Enabling Periodical Display of Logs on the Console and Remote Terminal

By default, periodical display of logs on the Console and remote terminal is disabled.

Run the **logging statistic terminal** command in global configuration mode to enable periodical display of logs on the Console and remote terminal.

↘ Configuring the Periodical Logging Interval

By default, the periodical logging interval is 15 minutes.

Run the **logging statistic mnemonic mnemonic interval minutes** command in global configuration mode to configure the periodical logging interval.

7.3.6 Syslog Monitoring

After syslog monitoring is enabled, the system monitors the access attempts of users and generates the related logs.

Working Principle

After logging of login/exit attempts is enabled, the system records the access attempts of users. The log contains user name and source address.

After logging of operations is enabled, the system records changes in device configurations, The log contains user name, source address, and operation.

Related Configuration

↘ Enabling Logging of Login or Exit Attempts

By default, a device does not generate logs when users access or exit the device.





Run the **logging userinfo** command in global configuration mode to enable logging of login/exit attempts. After this function is enabled, the device displays logs when users access the devices through Telnet, SSH, or HTTP so that the administrator can monitor the device connections.





↘ Enabling Logging of Operations



By default, a device does not generate logs when users modify device configurations.

Run the **logging userinfo command-log** command in global configuration mode to enable logging of operations. After this function is enabled, the system displays related logs to notify the administrator of configuration changes.

7.4 Configuration

| Configuration | Description and Command | |
|---|--|--|
| Configuring Syslog Format |  (Optional) It is used to configure the syslog format. | |
| | service timestamps [<i>message-type</i> [<i>uptime</i> <i>datetime</i> [<i>msec</i>] [<i>year</i>]]] | Configures the timestamp format of syslogs. |
| | service sysname | Adds the sysname to the syslog. |
| | service sequence-numbers | Adds the sequence number to the syslog. |
| | service standard-syslog | Enables the standard syslog format. |
| | service private-syslog | Enables the private syslog format. |
| | service log-format rfc5424 | Enables the RFC5424 syslog format. |
| Sending Syslogs to the Console |  (Optional) It is used to configure parameters for sending syslogs to the Console. | |
| | logging on | Enables logging. |
| | logging count | Enables log statistics. |
| | logging console [<i>level</i>] | Configures the level of logs displayed on the Console. |
| | logging rate-limit { <i>number</i> all <i>number</i> console { <i>number</i> all <i>number</i> } } [except [<i>severity</i>]] | Configures the log rate limit. |
| Sending Syslogs to the Monitor Terminal |  (Optional) It is used to configure parameters for sending syslogs to the monitor terminal. | |
| | terminal monitor | Enables the monitor terminal to display logs. |
| | logging monitor [<i>level</i>] | Configures the level of logs displayed on the monitor terminal. |
| Writing Syslogs into the Memory Buffer |  (Optional) It is used to configure parameters for writing syslogs into the memory buffer. | |
| | logging buffered [<i>buffer-size</i>] [<i>level</i>] | Configures parameters for writing syslogs into the memory buffer, including the buffer size and log level. |
| Sending Syslogs to the Log Server |  (Optional) It is used to configure parameters for sending syslogs to the log server. | |
| | logging server { <i>ip-address</i> ipv6 <i>ipv6-address</i> } [udp-port <i>port</i>] | Sends logs to a specified log server. |
| | logging trap [<i>level</i>] | Configures the level of logs sent to the log server. |

| Configuration | Description and Command | |
|---|--|--|
| | logging facility <i>facility-type</i> | Configures the facility value of logs sent to the log server. |
| | logging source [interface] <i>interface-type interface-number</i> | Configures the source interface of logs sent to the log server. |
| | logging source { ip <i>ip-address</i> ipv6 <i>ipv6-address</i> } | Configures the source address of logs sent to the log server. |
| Writing Syslogs into Log Files |  (Optional) It is used to configure parameters for writing syslogs into a file. | |
| | logging file flash:filename [<i>max-file-size</i>] [<i>level</i>] | Configures parameters for writing syslogs into a file, including the file storage type, file name, file size, and log level. |
| | logging flash interval <i>seconds</i> | Configures the interval at which logs are written into log files. The default value is 3600. |
| | logging life-time level <i>level days</i> | Configures the storage time of log files. |
| Configuring Syslog Filtering |  (Optional) It is used to enable the syslog filtering function. | |
| | logging filter direction { all buffer file server terminal } | Configures the log filtering direction. |
| | logging filter type { contains-only filter-only } | Configures the log filtering mode. |
| | logging filter rule exact-match module <i>module-name mnemonic mnemonic-name level level</i> | Configures the exact-match filtering rule. |
| Configuring Level-based Logging |  (Optional) It is used to configure logging policies to send the syslogs based on module and severity level . | |
| | logging policy module <i>module-name</i> [not-lesser-than] <i>level</i> direction { all server file console monitor buffer } | Sends logs to different destinations by module and severity level |
| Configuring Delayed Logging |  (Optional) It is used to enable the delayed logging function. | |
| | logging delay-send terminal | Enables delayed display of logs on the Console and remote terminal. |
| | logging delay-send file flash:filename | Configures the name of the file on the local device where logs are buffered. |
| | logging delay-send interval <i>seconds</i> | Configures the interval at which logs are sent to the log server. |

| Configuration | Description and Command | |
|--|---|--|
| | logging delay-send server { <i>ip-address</i> ipv6 <i>ipv6-address</i> } mode { ftp user <i>username</i> password [0 7] <i>password</i> tftp } | Configures the server address and delayed logging mode. |
| Configuring Periodical Logging |  (Optional) It is used to enable the periodical logging function. | |
| | logging statistic enable | Enables the periodical logging function . |
| | logging statistic terminal | Enables periodical display of logs on the Console and remote terminal. |
| | logging statistic mnemonic <i>mnemonic</i> interval <i>minutes</i> | Configures the interval at which logs of a performance statistic object are sent to the server . |
| Configuring Syslog Monitoring |  (Optional) It is used to configure parameters of the syslog monitoring function . | |
| | logging userinfo | Enables logging of login/exit attempts. |
| | logging userinfo command-log | Enables logging of operations. |

7.4.1 Configuring Syslog Format

Configuration Effect

- Configure the format of syslogs.

Notes

↘ RFC3164 Log Format

- If the device does not have the real time clock (RTC), which is used to record the system absolute time, the device uses its startup time (uptime) as the syslog timestamp by default. If the device has the RTC, the device uses its absolute time (datetime) as the syslog timestamp by default.
- The log sequence number is a 6-digit integer. Each time a log is generated, the sequence number increases by one. Each time the sequence number increases from 000000 to 1,000,000, or reaches 2^{32} , the sequence number starts from 000000 again.

↘ RFC5424 Log Format

- After the RFC5424 log format is enabled, the timestamp is uniform.
- In the RFC5424 log format, the timestamp may or may not contain the time zone. Currently, only the timestamp without the time zone is supported.

Configuration Steps

↘ Configuring the Timestamp Format of Syslogs

- (Optional) By default, the datetime timestamp format is used.
- Unless otherwise specified, perform this configuration on the device to configure the timestamp format.

✚ Adding the Sysname to the Syslog

- (Optional) By default, the syslog does not contain the sysname.
- Unless otherwise specified, perform this configuration on the device to add the sysname to the syslog.

✚ Adding the Sequence Number to the Syslog

- (Optional) By default, the syslog does not contain the sequence number.
- Unless otherwise specified, perform this configuration on the device to add the sequence number to the syslog.

✚ Enabling the Standard Log Format

- (Optional) By default, the default log format is used.
- Unless otherwise specified, perform this configuration on the device to enable the standard log format.

✚ Enabling the Private Log Format

- (Optional) By default, the default log format is used.
- Unless otherwise specified, perform this configuration on the device to enable the private log format.

✚ Enabling the RFC5424 Log Format

- (Optional) By default, the RFC5424 log format is disabled.
- Unless otherwise specified, perform this configuration on the device to enable the RFC5424 log format.

Verification

- Generate a syslog, and check the log format.

Related Commands

✚ Configuring the Timestamp Format of Syslogs

| | |
|------------------------------|---|
| Command | service timestamps [<i>message-type</i> [uptime datetime [msec] [year]]] |
| Parameter Description | <p><i>message-type</i>: Indicates the log type. There are two log types: log and debug.</p> <p>uptime: Indicates the device startup time in the format of dd:hh:mm:ss, for example, 07:00:10:41.</p> <p>datetime: Indicates the current device time in the format of MM DD hh:mm:ss, for example, Jul 27 16:53:07.</p> <p>msec: Indicates that the current device time contains millisecond.</p> <p>year: Indicates that the current device time contains year.</p> |
| Command Mode | Global configuration mode |

| | |
|----------------------------|---|
| Configuration Usage | Two syslog timestamp formats are available, namely, uptime and datetime. You can select a timestamp format as required. |
|----------------------------|---|

➤ **Adding the Sysname to the Syslog**

| | |
|------------------------------|--|
| Command | service sysname |
| Parameter Description | N/A |
| Command Mode | Global configuration mode |
| Configuration Usage | This command is used to add the sysname to the log to enable you to learn about the device that sends syslogs to the server. |

➤ **Adding the Sequence Number to the Syslog**

| | |
|------------------------------|---|
| Command | service sequence-numbers |
| Parameter Description | N/A |
| Command Mode | Global configuration mode |
| Configuration Usage | This command is used to add the sequence number to the log. The sequence number starts from 1. After the sequence number is added, you can learn clearly whether any log is lost and the generation sequence of logs. |

➤ **Enabling the Standard Syslog Format**

| | |
|------------------------------|--|
| Command | service standard-syslog |
| Parameter Description | N/A |
| Command Mode | Global configuration mode |
| Configuration Usage | <p>By default, logs are displayed in the following format (default format):</p> <pre>*timestamp: %module-level-mnemonic: content</pre> <p>If the standard syslog format is enabled, logs are displayed in the following format:</p> <pre>timestamp %module-level-mnemonic: content</pre> <p>Compared with the default format, an asterisk (*) is missing in front of the timestamp, and a colon (:) is missing at the end of the timestamp in the standard log format.</p> |

➤ **Enabling the Private Syslog Format**

| | |
|------------------------------|-------------------------------|
| Command | service private-syslog |
| Parameter Description | N/A |

| | |
|----------------------------|--|
| Command Mode | Global configuration mode |
| Configuration Usage | <p>By default, logs are displayed in the following format (default format):</p> <pre>*timestamp: %module-level-mnemonic: content</pre> <p>If the private syslog format is enabled, logs are displayed in the following format:</p> <pre>timestamp module-level-mnemonic: content</pre> <p>Compared with the default format, an asterisk (*) is missing in front of the timestamp, a colon (:) is missing at the end of the timestamp, and a percent sign (%) is missing in front of the module name in the private log format.</p> |

▾ **Enabling the RFC5424 Syslog Format**

| | |
|------------------------------|--|
| Command | service log-format rfc5424 |
| Parameter Description | N/A |
| Command Mode | Global configuration mode |
| Configuration Usage | <p>After the new format (RFC5424 log format) is enabled, the service sequence-numbers, service sysname, service timestamps, service private-syslog, and service standard-syslog commands that are applicable only to the old format (RFC3164 log format) loss effect and are hidden.</p> <p>After the old format (RFC3164 log format) is enabled, the logging delay-send, logging policy, and logging statistic commands that are applicable only to the RFC5424 log format loss effect and are hidden.</p> <p>After log format switchover, the outputs of the show logging and show logging config commands change accordingly.</p> |

Configuration Example

▾ **Enabling the RFC3164 Log Format**

| | |
|----------------------------|--|
| Scenario | <p>It is required to configure the timestamp format as follows:</p> <ol style="list-style-type: none"> 1. Enable the RFC3164 format. 2. Change the timestamp format to datetime and add the millisecond and year to the timestamp. 3. Add the sysname to the log. 4. Add the sequence number to the log. |
| Configuration Steps | <ul style="list-style-type: none"> ● Configure the syslog format. |
| | <pre>Ruijie# configure terminal Ruijie(config)# no service log-format rfc5424 Ruijie(config)# service timestamps log datetime year msec</pre> |

| | |
|---------------------|---|
| | <pre>Ruijie(config)# service timestamps debug datetime year msec Ruijie(config)# service sysname Ruijie(config)# service sequence-numbers</pre> |
| Verification | <p>After the timestamp format is configured, verify that new syslogs are displayed in the RFC3164 format.</p> <ul style="list-style-type: none"> ● Run the show logging config command to display the configuration. ● Enter or exit global configuration mode to generate a new log, and check the format of the timestamp in the new log. |
| | <pre>Ruijie(config)#exit 001302: *Jun 14 2013 19:01:40.293: Ruijie %SYS-5-CONFIG_I: Configured from console by admin on console Ruijie#show logging config Syslog logging: enabled Console logging: level informational, 1306 messages logged Monitor logging: level informational, 0 messages logged Buffer logging: level informational, 1306 messages logged File logging: level informational, 121 messages logged File name:syslog_test.txt, size 128 Kbytes, have written 5 files Standard format:false Timestamp debug messages: datetime Timestamp log messages: datetime Sequence-number log messages: enable Sysname log messages: enable Count log messages: enable Trap logging: level informational, 121 message lines logged,0 fail</pre> |

↘ **Enabling the RFC5424 Log Format**

| | |
|----------------------------|--|
| Scenario | It is required to enable the RFC5424 format. |
| Configuration Steps | <ul style="list-style-type: none"> ● Configure the syslog format. |
| | <pre>Ruijie# configure terminal Ruijie(config)# service log-format rfc5424</pre> |
| Verification | <p>Verify that new syslogs are displayed in the RFC5424 format.</p> <ul style="list-style-type: none"> ● Run the show logging config command to display the configuration. |

- Enter or exit global configuration mode to generate a new log, and check the format of the new log.

```
Ruijie(config)#exit
<133>1 2013-07-24T12:19:33.130290Z ruijie SYS 5 CONFIG - Configured from console by console
Ruijie#show logging config
Syslog logging: enabled
  Console logging: level debugging, 4740 messages logged
  Monitor logging: level debugging, 0 messages logged
  Buffer logging: level debugging, 4745 messages logged
  Statistic log messages: disable
  Statistic log messages to terminal: disable
  Delay-send file name:syslog_ftp_server, Current write index:3, Current send index:3,
  Cycle:10 seconds
  Count log messages: enable
  Trap logging: level informational, 2641 message lines logged,4155 fail
    logging to 192.168.23.89
    logging to 2000::1
  Delay-send logging: 2641 message lines logged
    logging to 192.168.23.89 by tftp
```

7.4.2 Sending Syslogs to the Console

Configuration Effect

- Send syslogs to the Console to facilitate the administrator to monitor the performance of the system.

Notes

- If too many syslogs are generated, you can limit the log rate to reduce the number of logs displayed on the Console.

Configuration Steps

▾ Enabling Logging

- (Optional) By default, the logging function is enabled.

▾ Enabling Log Statistics

- (Optional) By default, log statistics is disabled.
- Unless otherwise specified, perform this configuration on the device to enable log statistics.

▾ Configuring the Level of Logs Displayed on the Console

- (Optional) By default, the level of logs displayed on the Console is debugging (Level 7).
- Unless otherwise specified, perform this configuration on the device to configure the level of logs displayed on the Console.

▾ Configuring the Log Rate Limit

- (Optional) By default, the no rate limit is configured.
- Unless otherwise specified, perform this configuration on the device to limit the log rate.

Verification

- Run the **show logging config** command to display the level of logs displayed on the Console.

Related Commands

▾ Enabling Logging

| | |
|------------------------------|--|
| Command | logging on |
| Parameter Description | N/A |
| Command Mode | Global configuration mode |
| Configuration Usage | By default, logging is enabled. Do not disable logging in general cases. If too many syslogs are generated, you can configure log levels to reduce the number of logs. |

▾ Enabling Log Statistics

| | |
|------------------------------|--|
| Command | logging count |
| Parameter Description | N/A |
| Command Mode | Global configuration mode |
| Configuration Usage | By default, log statistics is disabled. If log statistics is enabled, syslogs will be classified and counted. The system records the number of times a log is generated and the last time when the log is generated. |

▾ Configuring the Level of Logs Displayed on the Console

| | |
|------------------------------|--|
| Command | logging console [<i>level</i>] |
| Parameter Description | <i>level</i> : Indicates the log level. |
| Command Mode | Global configuration mode |
| Configuration Usage | By default, the level of logs displayed on the Console is debugging (Level 7). You can run the show logging config command in privileged EXEC mode to display the level of logs displayed on the Console. |

▾ **Configuring the Log Rate Limit**

| | |
|------------------------------|---|
| Command | logging rate-limit { <i>number</i> all <i>number</i> console { <i>number</i> all <i>number</i> } } [except [<i>severity</i>]] |
| Parameter Description | <i>number</i> : Indicates the maximum number of logs processed per second. The value ranges from 1 to 10,000. all : Indicates that rate limit is applied to all logs ranging from Level 0 to Level 7. console : Indicates the number of logs displayed on the Console per second. except severity : Rate limit is not applied to logs with a level equaling to or lower than the specified severity level. By default, the severity level is error (Level 3), that is, rate limit is not applied to logs of Level 3 or lower. |
| Command Mode | Global configuration mode |
| Configuration Usage | By default, no rate limit is configured. |

Configuration Example

▾ **Sending Syslogs to the Console**

| | |
|----------------------------|--|
| Scenario | It is required to configure the function of displaying syslogs on the Console as follows: 1. Enable log statistics. 2. Set the level of logs that can be displayed on the Console to informational (Level 6). 3. Set the log rate limit to 50. |
| Configuration Steps | <ul style="list-style-type: none"> Configure parameters for displaying syslogs on the Console. <pre>Ruijie# configure terminal Ruijie(config)# logging count Ruijie(config)# logging console informational Ruijie(config)# logging rate-limit console 50</pre> |
| Verification | <ul style="list-style-type: none"> Run the show logging config command to display the configuration. <pre>Ruijie(config)#show logging config Syslog logging: enabled Console logging: level informational, 1303 messages logged Monitor logging: level debugging, 0 messages logged Buffer logging: level debugging, 1303 messages logged File logging: level informational, 118 messages logged File name:syslog_test.txt, size 128 Kbytes, have written 5 files Standard format:false Timestamp debug messages: datetime</pre> |

| | |
|----------------------------|---|
| Scenario | It is required to configure the function of displaying syslogs on the Console as follows: <ol style="list-style-type: none"> 1. Enable log statistics. 2. Set the level of logs that can be displayed on the Console to informational (Level 6). 3. Set the log rate limit to 50. |
| Configuration Steps | <ul style="list-style-type: none"> ● Configure parameters for displaying syslogs on the Console. <pre>Ruijie# configure terminal Ruijie(config)# logging count Ruijie(config)# logging console informational Ruijie(config)# logging rate-limit console 50</pre> |
| Verification | <ul style="list-style-type: none"> ● Run the show logging config command to display the configuration. <pre>Timestamp log messages: datetime Sequence-number log messages: enable Sysname log messages: enable Count log messages: enable Trap logging: level informational, 118 message lines logged, 0 fail</pre> |

7.4.3 Sending Syslogs to the Monitor Terminal

Configuration Effect

- Send syslogs to a remote monitor terminal to facilitate the administrator to monitor the performance of the system.

Notes

- If too many syslogs are generated, you can limit the log rate to reduce the number of logs displayed on the monitor terminal.
- By default, the current monitor terminal is not allowed to display logs after you access the device remotely. You need to manually run the **terminal monitor** command to allow the current monitor terminal to display logs.

Configuration Steps

▾ Allowing the Monitor Terminal to Display Logs

- (Mandatory) By default, the monitor terminal is not allowed to display logs.
- Unless otherwise specified, perform this operation on every monitor terminal connected to the device.

▾ Configuring the Level of Logs Displayed on the Monitor Terminal

- (Optional) By default, the level of logs displayed on the monitor terminal is debugging (Level 7).

- Unless otherwise specified, perform this configuration on the device to configure the level of logs displayed on the monitor terminal.

Verification

- Run the **show logging config** command to display the level of logs displayed on the monitor terminal.

Related Commands

▾ Allowing the Monitor Terminal to Display Logs

| | |
|------------------------------|---|
| Command | terminal monitor |
| Parameter Description | N/A |
| Command Mode | Privileged EXEC mode |
| Configuration Usage | By default, the current monitor terminal is not allowed to display logs after you access the device remotely. You need to manually run the terminal monitor command to allow the current monitor terminal to display logs. |

▾ Configuring the Level of Logs Displayed on the Monitor Terminal

| | |
|------------------------------|--|
| Command | logging monitor [<i>level</i>] |
| Parameter Description | <i>level</i> : Indicates the log level. |
| Command Mode | Global configuration mode |
| Configuration Usage | By default, the level of logs displayed on the monitor terminal is debugging (Level 7). You can run the show logging config command in privileged EXEC mode to display the level of logs displayed on the monitor terminal. |

Configuration Example

▾ Sending Syslogs to the Monitor Terminal

| | |
|----------------------------|---|
| Scenario | It is required to configure the function of displaying syslogs on the monitor terminal as follows: 1. Display logs on the monitor terminal. 2. Set the level of logs that can be displayed on the monitor terminal to informational (Level 6). |
| Configuration Steps | <ul style="list-style-type: none"> Configure parameters for displaying syslogs on the monitor terminal. |
| | <pre>Ruijie# configure terminal Ruijie(config)# logging monitor informational Ruijie(config)# line vty 0 4 Ruijie(config-line)# monitor</pre> |
| Verification | <ul style="list-style-type: none"> Run the show logging config command to display the configuration. |
| | <pre>Ruijie#show logging config Syslog logging: enabled Console logging: level informational, 1304 messages logged Monitor logging: level informational, 0 messages logged Buffer logging: level debugging, 1304 messages logged File logging: level informational, 119 messages logged File name:syslog_test.txt, size 128 Kbytes, have written 5 files Standard format:false Timestamp debug messages: datetime Timestamp log messages: datetime Sequence-number log messages: enable Sysname log messages: enable Count log messages: enable Trap logging: level informational, 119 message lines logged,0 fail</pre> |

Common Errors

- To disable this function, run the **terminal no monitor** command, instead of the **no terminal monitor** command.

7.4.4 Writing Syslogs into the Memory Buffer

Configuration Effect

- Write syslogs into the memory buffer so that the administrator can view recent syslogs by running the **show logging** command.

Notes

- If the buffer is full, old logs will be overwritten by new logs that are written into the memory buffer.

Configuration Steps

Writing Logs into the Memory Buffer

- (Optional) By default, the system writes logs into the memory buffer, and the default level of logs is debugging (Level 7).
- Unless otherwise specified, perform this configuration on the device to write logs into the memory buffer.

Verification

- Run the **show logging config** command to display the level of logs written into the memory buffer.
- Run the **show logging** command to display the level of logs written into the memory buffer.

Related Commands

Writing Logs into the Memory Buffer

| | |
|----------------------------|--|
| Command | logging buffered [<i>buffer-size</i>] [<i>level</i>] |
| Parameter | <i>buffer-size</i> : Indicates the size of the memory buffer. |
| Description | <i>level</i> : Indicates the level of logs that can be written into the memory buffer. |
| Command Mode | Global configuration mode |
| Configuration Usage | By default, the level of logs written into the memory buffer is debugging (Level 7). Run the show logging command in privileged EXEC mode to display the level of logs written into the memory buffer and the buffer size. |

Configuration Example

Writing Syslogs into the Memory Buffer

| | |
|----------------------------|---|
| Scenario | It is required to configure the function of writing syslogs into the memory buffer as follows: 1. Set the log buffer size to 128 KB (131,072 bytes). 2. Set the information level of logs that can be written into the memory buffer to informational (Level 6). |
| Configuration Steps | <ul style="list-style-type: none"> ● Configure parameters for writing syslogs into the memory buffer. <pre>Ruijie# configure terminal Ruijie(config)# logging buffered 131072 informational</pre> |
| Verification | <ul style="list-style-type: none"> ● Run the show logging config command to display the configuration and recent syslogs. <pre>Ruijie#show logging Syslog logging: enabled Console logging: level informational, 1306 messages logged Monitor logging: level informational, 0 messages logged</pre> |

| | |
|----------------------------|---|
| Scenario | It is required to configure the function of writing syslogs into the memory buffer as follows: 1. Set the log buffer size to 128 KB (131,072 bytes). 2. Set the information level of logs that can be written into the memory buffer to informational (Level 6). |
| Configuration Steps | <ul style="list-style-type: none"> Configure parameters for writing syslogs into the memory buffer. |
| | <pre>Ruijie# configure terminal Ruijie(config)# logging buffered 131072 informational</pre> |
| Verification | <ul style="list-style-type: none"> Run the show logging config command to display the configuration and recent syslogs. |
| | <pre>Buffer logging: level informational, 1306 messages logged File logging: level informational, 121 messages logged File name:syslog_test.txt, size 128 Kbytes, have written 5 files Standard format:false Timestamp debug messages: datetime Timestamp log messages: datetime Sequence-number log messages: enable Sysname log messages: enable Count log messages: enable Trap logging: level informational, 121 message lines logged,0 fail Log Buffer (Total 131072 Bytes): have written 4200 001301: *Jun 14 2013 19:01:09.488: Ruijie %SYS-5-CONFIG_I: Configured from console by admin on console 001302: *Jun 14 2013 19:01:40.293: Ruijie %SYS-5-CONFIG_I: Configured from console by admin on console //Logs displayed are subject to the actual output of the show logging command.</pre> |

7.4.5 Sending Syslogs to the Log Server

Configuration Effect

- Send syslogs to the log server to facilitate the administrator to monitor logs on the server.

Notes

- To send logs to the log server, you must add the timestamp and sequence number to logs. Otherwise, the logs are not sent to the log server.

Configuration Steps

✚ Sending Logs to a Specified Log Server

- (Mandatory) By default, syslogs are not sent to any log server.
- Unless otherwise specified, perform this configuration on every device.

✚ Configuring the Level of Logs Sent to the Log Server

- (Optional) By default, the level of logs sent to the log server is informational (Level 6).
- Unless otherwise specified, perform this configuration on the device to configure the level of logs sent to the log server.

✚ Configuring the Facility Value of Logs Sent to the Log Server

- (Optional) If the RFC5424 format is disabled, the facility value of logs sent to the log server is local7 (23) by default. If the RFC5424 format is enabled, the facility value of logs sent to the log server is local0 (16) by default.
- Unless otherwise specified, perform this configuration on the device to configure the facility value of logs sent to the log server.

✚ Configuring the Source Interface of Logs Sent to the Log Server

- (Optional) By default, the source interface of logs sent to the log server is the interface sending the logs.
- Unless otherwise specified, perform this configuration on the device to configure the source interface of logs sent to the log server.

✚ Configuring the Source Address of Logs Sent to the Log Server

- (Optional) By default, the source address of logs sent to the log server is the IP address of the interface sending the logs.
- Unless otherwise specified, perform this configuration on the device to configure the source address of logs sent to the log server.

Verification

- Run the **show logging config** command to display the configurations related to the log server.

Related Commands

✚ Sending Logs to a Specified Log Server

| | |
|------------------------------|--|
| Command | logging server { <i>ip-address</i> ipv6 <i>ipv6-address</i> } [udp-port <i>port</i>] Or logging { <i>ip-address</i> ipv6 <i>ipv6-address</i> } [udp-prot <i>port</i>] |
| Parameter Description | <i>ip-address</i> : Specifies the IP address of the host that receives logs. ipv6 <i>ipv6-address</i> : Specifies the IPv6 address of the host that receives logs. udp-port <i>port</i> : Specifies the port ID of the log server. The default port ID is 514. |
| Command Mode | Global configuration mode |
| Configuration Usage | This command is used to specify the address of the log server that receives logs. You can specify multiple log servers, and logs will be sent simultaneously to all these log servers. |

 You can configure up to five log servers on a Ruijie product.

▾ Configuring the Level of Logs Sent to the Log Server

| | |
|------------------------------|---|
| Command | logging trap [<i>level</i>] |
| Parameter Description | <i>level</i> : Indicates the log level. |
| Command Mode | Global configuration mode |
| Configuration Usage | By default, the level of logs sent to the log server is informational (Level 6). You can run the show logging config command in privileged EXEC mode to display the level of logs sent to the log server. |

▾ Configuring the Facility Value of Logs Sent to the Log Server

| | |
|------------------------------|--|
| Command | logging facility <i>facility-type</i> |
| Parameter Description | <i>facility-type</i> : Indicates the facility value of logs. |
| Command Mode | Global configuration mode |
| Configuration Usage | If the RFC5424 format is disabled, the facility value of logs sent to the server is local7 (23) by default. If the RFC5424 format is enabled, the facility value of logs sent to the server is local0 (16) by default. |

▾ Configuring the Source Interface of Logs Sent to the Log Server

| | |
|------------------------------|---|
| Command | logging source [interface] <i>interface-type interface-number</i> |
| Parameter Description | <i>interface-type</i> : Indicates the interface type. <i>interface-number</i> : Indicates the interface number. |
| Command Mode | Global configuration mode |
| Configuration Usage | By default, the source interface of logs sent to the log server is the interface sending the logs. To facilitate management, you can use this command to set the source interface of all logs to an interface so that the administrator can identify the device that sends the logs based on the unique address. |

▾ Configuring the Source Address of Logs Sent to the Log Server

| | |
|------------------------------|--|
| Command | logging source { ip <i>ip-address</i> ipv6 <i>ipv6-address</i> } |
| Parameter Description | ip <i>ip-address</i> : Specifies the source IPv4 address of logs sent to the IPv4 log server. ipv6 <i>ipv6-address</i> : Specifies the source IPv6 address of logs sent to the IPv6 log server. |
| Command Mode | Global configuration mode |
| Configuration Usage | By default, the source IP address of logs sent to the log server is the IP address of the interface sending the logs. |

| | |
|--|---|
| | To facilitate management, you can use this command to set the source IP address of all logs to the IP address of an interface so that the administrator can identify the device that sends the logs based on the unique address.. |
|--|---|

Configuration Example

▾ Sending Syslogs to the Log Server

| | |
|----------------------------|---|
| Scenario | It is required to configure the function of sending syslogs to the log server as follows: <ol style="list-style-type: none"> 1. Set the IPv4 address of the log server to 10.1.1.100. 2. Set the level of logs that can be sent to the log server to debugging (Level 7). 3. Set the source interface to Loopback 0. |
| Configuration Steps | <ul style="list-style-type: none"> ● Configure parameters for sending syslogs to the log server. |
| | <pre>Ruijie# configure terminal Ruijie(config)# logging server 10.1.1.100 Ruijie(config)# logging trap debugging Ruijie(config)# logging source interface Loopback 0</pre> |
| Verification | <ul style="list-style-type: none"> ● Run the show logging config command to display the configuration. |
| | <pre>Ruijie#show logging config Syslog logging: enabled Console logging: level informational, 1307 messages logged Monitor logging: level informational, 0 messages logged Buffer logging: level informational, 1307 messages logged File logging: level informational, 122 messages logged File name:syslog_test.txt, size 128 Kbytes, have written 5 files Standard format:false Timestamp debug messages: datetime Timestamp log messages: datetime Sequence-number log messages: enable Sysname log messages: enable Count log messages: enable Trap logging: level debugging, 122 message lines logged,0 fail logging to 10.1.1.100</pre> |

7.4.6 Writing Syslogs into Log Files

Configuration Effect

- Write syslogs into log files at the specified interval so that the administrator can view history logs anytime on the local device.

Notes

- Syslogs are not immediately written into log files. They are first buffered in the memory buffer, and then written into log files either periodically (at the interval of one hour by default) or when the buffer is full.

Configuration Steps

↳ Writing Logs into Log Files

- (Mandatory) By default, syslogs are not written to any log file.
- Unless otherwise specified, perform this configuration on every device.

↳ Configuring the Number of Log Files

- (Optional) By default, syslogs are written to 16 log files.
- Unless otherwise specified, perform this configuration on the device to configure the number of files which logs are written into.

↳ Configuring the Interval at Which Logs Are Written into Log Files

- (Optional) By default, syslogs are written to log files every hour.
- Unless otherwise specified, perform this configuration on the device to configure the interval at which logs are written into log files.

↳ Configuring the Storage Time of Log Files

- (Optional) By default, no storage time is configured.
- Unless otherwise specified, perform this configuration on the device to configure the storage time of log files.

↳ Immediately Writing Logs in the Buffer into Log Files

- (Optional) By default, syslogs are stored in the buffer and then written into log files periodically or when the buffer is full.
- Unless otherwise specified, perform this configuration to write logs in the buffer into log files immediately. This command takes effect only once after it is configured.

Verification

- Run the **show logging config** command to display the configurations related to the log server.

Related Commands

Writing Logs into Log Files

| | |
|------------------------------|--|
| Command | logging file { flash:filename usb0:filename usb1:filename sd0:filename } [<i>max-file-size</i>] [<i>level</i>] |
| Parameter Description | <p>flash: Indicates that log files will be stored on the extended Flash.</p> <p>usb0: Indicates that log files will be stored on USB 0. This option is supported only when the device has one USB port and a USB flash drive is inserted into the USB port.</p> <p>usb1: Indicates that log files will be stored on USB 1. This option is supported only when the device has two USB ports and USB flash drives are inserted into the USB ports.</p> <p>sd0: Indicates that log files will be stored on the SD card. This option is supported only when the device has an SD port and an SD card is inserted into the SD port.</p> <p><i>filename:</i> Indicates the log file name, which does not contain a file name extension. The file name extension is always txt.</p> <p><i>max-file-size:</i> Indicates the maximum size of a log file. The value ranges from 128 KB to 6 MB. The default value is 128 KB.</p> <p><i>level:</i> Indicates the level of logs that can be written into a log file.</p> |
| Command Mode | Global configuration mode |
| Configuration Usage | <p>This command is used to create a log file with the specified file name on the specified file storage device. The file size increases with the amount of logs, but cannot exceed the configured maximum size. If not specified, the maximum size of a log file is 128 KB by default.</p> <p>After this command is configured, the system saves logs to log files. A log file name does not contain any file name extension. The file name extension is always txt, which cannot be changed.</p> <p>After this command is configured, logs will be written into log files every hour. If you run the logging file flash:syslog command, a total of 16 log files will be created, namely, syslog.txt, syslog_1.txt, syslog_2.txt, ..., syslog_14.txt, and syslog_15.txt. Logs are written into the 16 log files in sequence. For example, the system writes logs into syslog_1.txt after syslog.txt is full. When syslog_15.txt is full, logs are written into syslog.txt again,</p> |

Configuring the Interval at Which Logs Are Written into Log Files

| | |
|------------------------------|--|
| Command | logging flash interval <i>seconds</i> |
| Parameter Description | <i>seconds:</i> Indicates the interval at which logs are written into log files. The value ranges from 1s to 51,840s. |
| Command Mode | Global configuration mode |
| Configuration Usage | This command is used to configure the interval at which logs are written into log files. The countdown starts after the command is configured. |

Configuring the Storage Time of Log Files

| | |
|------------------------------|---|
| Command | logging life-time level <i>level days</i> |
| Parameter Description | <p><i>level:</i> Indicates the log level.</p> <p><i>days:</i> Indicates the storage time of log files. The unit is day. The storage time is not less than seven days.</p> |

| | |
|----------------------------|---|
| Command Mode | Global configuration mode |
| Configuration Usage | <p>After the log storage time is configured, the system writes logs of the same level that are generated in the same day into the same log file. The log file is named yyyy-mm-dd_filename_level.txt, where yyyy-mm-dd is the absolute time of the day when the logs are generated, filename is the log file named configured by the logging file flash command, and level is the log level.</p> <p>After you specify the storage time for logs of a certain level, the system deletes the logs after the storage time expires. Currently, the storage time ranges from 7days to 365 days.</p> <p>If the log storage time is not configured, logs are stored based on the file size to ensure compatibility with old configuration commands.</p> |

↘ **Immediately Writing Logs in the Buffer into Log Files**

| | |
|------------------------------|---|
| Command | logging flash flush |
| Parameter Description | N/A |
| Command Mode | Global configuration mode |
| Configuration Usage | <p>After this command is configured, syslogs are stored in the buffer and then written into log files periodically or when the buffer is full. You can run this command to immediately write logs into log files.</p> <hr/> <p> The logging flash flush command takes effect once after it is configured. That is, after this command is configured, logs in the buffer are immediately written to log files.</p> <hr/> |

Configuration Example

↘ **Writing Syslogs into Log Files**

| | |
|----------------------------|--|
| Scenario | <p>It is required to configure the function of writing syslogs into log files as follows:</p> <ol style="list-style-type: none"> 1. Set the log file name to syslog. 2. Set the level of logs sent to the Console to debugging (Level 7). 3. Set the interval at which device logs are written into files to 10 minutes (600s). |
| Configuration Steps | <ul style="list-style-type: none"> ● Configure parameters for writing syslogs into log files. <pre>Ruijie# configure terminal Ruijie(config)# logging file flash:syslog debugging Ruijie(config)# logging flash interval 600</pre> |
| Verification | <ul style="list-style-type: none"> ● Run the show logging config command to display the configuration. <pre>Ruijie(config)#show logging config Syslog logging: enabled Console logging: level informational, 1307 messages logged</pre> |

| | |
|----------------------------|---|
| Scenario | It is required to configure the function of writing syslogs into log files as follows: 1. Set the log file name to syslog. 2. Set the level of logs sent to the Console to debugging (Level 7). 3. Set the interval at which device logs are written into files to 10 minutes (600s). |
| Configuration Steps | <ul style="list-style-type: none"> Configure parameters for writing syslogs into log files. |
| | <pre>Ruijie# configure terminal Ruijie(config)# logging file flash:syslog debugging Ruijie(config)# logging flash interval 600</pre> |
| Verification | <ul style="list-style-type: none"> Run the show logging config command to display the configuration. |
| | <pre>Monitor logging: level informational, 0 messages logged Buffer logging: level informational, 1307 messages logged File logging: level debugging, 122 messages logged File name:syslog.txt, size 128 Kbytes, have written 1 files Standard format:false Timestamp debug messages: datetime Timestamp log messages: datetime Sequence-number log messages: enable Sysname log messages: enable Count log messages: enable Trap logging: level debugging, 122 message lines logged,0 fail logging to 10.1.1.100</pre> |

7.4.7 Configuring Syslog Filtering

Configuration Effect

- Filter out a specified type of syslogs if the administrator does not want to display these syslogs.
- By default, logs generated by all modules are displayed on the Console or other terminals. You can configure log filtering rules to display only desired logs.

Notes

- Two filtering modes are available: contains-only and filter-only. You can configure only one filtering mode at a time.
- If the same module, level, or mnemonic is configured in both the single-match and exact-match rules, the single-match rule prevails over the exact-match rule.

Configuration Steps

↘ Configuring the Log Filtering Direction

- (Optional) By default, the filtering direction is all, that is, all logs are filtered out.
- Unless otherwise specified, perform this configuration on the device to configure the log filtering direction.

↘ Configuring the Log Filtering Mode

- (Optional) By default, the log filtering mode is filter-only.
- Unless otherwise specified, perform this configuration on the device to configure the log filtering mode.

↘ Configuring the Log Filtering Rule

- (Mandatory) By default, no filtering rule is configured.
- Unless otherwise specified, perform this configuration on the device to configure the log filtering rule.

Verification

- Run the **show running** command to display the configuration.

Related Commands

↘ Configuring the Log Filtering Direction

| | |
|------------------------------|--|
| Command | logging filter direction { all buffer file server terminal } |
| Parameter Description | all: Filters out all logs. buffer: Filters out logs sent to the log buffer, that is, the logs displayed by the show logging command. file: Filters out logs written into log files. server: Filters out logs sent to the log server. terminal: Filters out logs sent to the Console and VTY terminal (including Telnet and SSH). |
| Command Mode | Global configuration mode |
| Configuration Usage | The default filtering direction is all , that is, all logs are filtered out. Run the default logging filter direction command to restore the default filtering direction. |

↘ Configuring the Log Filtering Mode

| | |
|------------------------------|--|
| Command | logging filter type { contains-only filter-only } |
| Parameter Description | contains-only: Indicates that only logs that contain keywords specified in the filtering rules are displayed. filter-only: Indicates that logs that contain keywords specified in the filtering rules are filtered out and will not be displayed. |
| Command Mode | Global configuration mode |
| Configuration Usage | Log filtering modes include contains-only and filter-only. The default filtering mode is filter-only. |

▾ Configuring the Log Filtering Rule

| | |
|------------------------------|---|
| Command | logging filter rule { exact-match module <i>module-name mnemonic mnemonic-name level level</i> single-match { level level mnemonic mnemonic-name module module-name } } |
| Parameter Description | <p>exact-match: If exact-match is selected, you must specify all three filtering options.</p> <p>single-match: If single-match is selected, you may specify only one of the three filtering options.</p> <p>module module-name: Indicates the module name. Logs of this module will be filtered out.</p> <p>mnemonic mnemonic-name: Indicates the mnemonic. Logs with this mnemonic will be filtered out.</p> <p>level level: Indicates the log level. Logs of this level will be filtered out.</p> |
| Command Mode | Global configuration mode |
| Configuration Usage | <p>Log filtering rules include exact-match and single-match.</p> <p>The no logging filter rule exact-match [module module-name mnemonic mnemonic-name level level] command is used to delete the exact-match filtering rules. You can delete all exact-match filtering rules at a time or one by one.</p> <p>The no logging filter rule single-match [level level mnemonic mnemonic-name module module-name] command is used to delete the single-match filtering rules. You can delete all single-match filtering rules at a time or one by one.</p> |

Configuration Example

▾ Configuring Syslog Filtering

| | |
|----------------------------|---|
| Scenario | <p>It is required to configure the syslog filtering function as follows:</p> <ol style="list-style-type: none"> 1. Set the filtering directions of logs to terminal and server. 2. Set the log filtering mode to filter-only. 3. Set the log filtering rule to single-match to filter out logs that contain the module name "SYS". |
| Configuration Steps | <ul style="list-style-type: none"> ● Configure the syslog filtering function. |
| | <pre>Ruijie# configure terminal Ruijie(config)# logging filter direction server Ruijie(config)# logging filter direction terminal Ruijie(config)# logging filter type filter-only Ruijie(config)# logging filter rule single-match module SYS</pre> |
| Verification | <ul style="list-style-type: none"> ● Run the show running-config include logging command to display the configuration. ● Enter and exit global configuration mode, and verify that the system displays logs accordingly. |
| | <pre>Ruijie#configure Enter configuration commands, one per line. End with CNTL/Z. Ruijie(config)#exit</pre> |

| | |
|----------------------------|--|
| Scenario | It is required to configure the syslog filtering function as follows: 1. Set the filtering directions of logs to terminal and server . 2. Set the log filtering mode to filter-only. 3. Set the log filtering rule to single-match to filter out logs that contain the module name "SYS". |
| Configuration Steps | <ul style="list-style-type: none"> Configure the syslog filtering function. |
| | <pre>Ruijie# configure terminal Ruijie(config)# logging filter direction server Ruijie(config)# logging filter direction terminal Ruijie(config)# logging filter type filter-only Ruijie(config)# logging filter rule single-match module SYS</pre> |
| Verification | <ul style="list-style-type: none"> Run the show running-config include logging command to display the configuration. Enter and exit global configuration mode, and verify that the system displays logs accordingly. |
| | <pre>Ruijie# Ruijie#show running-config include logging logging filter direction server logging filter direction terminal logging filter rule single-match module SYS</pre> |

7.4.8 Configuring Level-based Logging

Configuration Effect

- You can use the level-based logging function to send syslogs to different destinations based on different module and severity level. For example, you can configure a command to send WLAN module logs of Level 4 or lower to the log server, and WLAN module logs of Level 5 or higher to local log files.

Notes

- Level-based logging takes effect only when the RFC5424 format is enabled.

Configuration Steps

▾ Configuring Level-based Logging

- (Optional) By default, logs are sent in all directions.
- Unless otherwise specified, perform this configuration on the device to configure logging polices to send syslogs to different destinations based on module and severity level.

Verification

- Run the **show running** command to display the configuration.

Related Commands

↘ Configuring Level-based Logging

| | |
|------------------------------|---|
| Command | logging policy module <i>module-name</i> [not-lesser-than] <i>level</i> direction { all server file console monitor buffer } |
| Parameter Description | <p><i>module-name</i>: Indicates the name of the module to which the logging policy is applied.</p> <p>not-lesser-than: If this option is specified, logs of the specified level or higher will be sent to the specified destination, and other logs will be filtered out. If this option is not specified, logs of the specified level or lower will be sent to the specified destination, and other logs will be filtered out.</p> <p><i>level</i>: Indicates the level of logs for which the logging policy is configured.</p> <p>all: Indicates that the logging policy is applied to all logs.</p> <p>server: Indicates that the logging policy is applied only to logs sent to the log server.</p> <p>file: Indicates that the logging policy is applied only to logs written into log files.</p> <p>console: Indicates that the logging policy is applied only to logs sent to the Console.</p> <p>monitor: Indicates that the logging policy is applied only to logs sent to a remote terminal.</p> <p>buffer: Indicates that the logging policy is applied only to logs stored in the buffer.</p> |
| Command Mode | Global configuration mode |
| Configuration Usage | This command is used to configure logging polices to send syslogs to different destinations based on module and severity level. |

Configuration Example

↘ Configuring Level-based Logging

| | |
|----------------------------|---|
| Scenario | It is required to configure the logging policies as follows: 1. Send logs of Level 5 or higher that are generated by the system to the Console. 2. Send logs of Level 3 or lower that are generated by the system to the buffer. |
| Configuration Steps | <ul style="list-style-type: none"> Configure the logging policies. |
| | <pre>Ruijie# configure terminal Ruijie(config)# logging policy module SYS not-lesser-than 5 direction console Ruijie(config)# logging policy module SYS 3 direction buffer</pre> |
| Verification | <ul style="list-style-type: none"> Run the show running-config include logging policy command to display the configuration. Exit and enter global configuration mode to generate a log containing module name "SYS". Verify that the log is sent to the destination as configured. |
| | <pre>Ruijie#show running-config include logging policy logging policy module SYS not-lesser-than 5 direction console logging policy module SYS 3 direction buffer</pre> |

7.4.9 Configuring Delayed Logging

Configuration Effect

- By default, delayed logging is enabled by default at the interval of 3600s (one hour). The name of the log file sent to the remote server is **File size_Device IP address_Index.txt**. Logs are not sent to the Console or remote terminal.
- You can configure the interval based on the frequency that the device generates logs for delayed uploading. This can reduce the burden on the device, syslog server, and network. In addition, you can configure the name of the log file as required.

Notes

- This function takes effect only when the RFC5424 format is enabled.
- It is recommended to disable the delayed display of logs on the Console and remote terminal. Otherwise, a large amount of logs will be displayed, increasing the burden on the device.
- The file name cannot contain any dot (.) because the system automatically adds the index and the file name extension (.txt) to the file name when generating a locally buffered file. The index increases each time a new file is generated. In addition, the file name cannot contain characters prohibited by your file system, such as \, /, :, *, ", <, >, and |. For example, the file name is log_server, the current file index is 5, the file size is 1000 bytes, and the source IP address is 10.2.3.5. The name of the log file sent to the remote server is **log_server_1000_10.2.3.5_5.txt** while the name of the log file stored on the device is **log_server_5.txt**. If the source IP address is an IPv6 address, the colon (:) in the IPv6 address must be replaced by the hyphen (-) because the colon (:) is prohibited by the file system. For example, the file name is log_server, the current file index is 6, the file size is 1000 bytes, and the source IPv6 address is 2001::1. The name of the log file

sent to the remote server is `log_server_1000_2001-1_6.txt` while the name of the log file stored on the device is `log_server_6.txt`.

- If few logs are generated, you can set the interval to a large value so that many logs can be sent to the remote server at a time.

Configuration Steps

↘ Enabling Delayed Display of Logs on Console and Remote Terminal

- (Optional) By default, delayed display of logs on the Console and remote terminal is disabled.
- Unless otherwise specified, perform this configuration on the device to enable delayed display of logs on the Console and remote terminal.

↘ Configuring the Name of the File for Delayed Logging

- (Optional) By default, the name of the file for delayed logging is *File size_Device IP address_Index.txt*.
- Unless otherwise specified, perform this configuration on the device to configure the name of the file for delayed logging.

↘ Configuring the Delayed Logging Interval

- (Optional) By default, the delayed logging interval is 3600s (one hour).
- Unless otherwise specified, perform this configuration on the device to configure the delayed logging interval.

↘ Configuring the Server Address and Delayed Logging Mode

- (Optional) By default, log files are not sent to any remote server.
- Unless otherwise specified, perform this configuration on the device to configure the server address and delayed logging mode

Verification

- Run the **show running** command to display the configuration.

Related Commands

↘ Enabling Delayed Display of Logs on Console and Remote Terminal

| | |
|----------------------------|------------------------------------|
| Command | logging delay-send terminal |
| Parameter | N/A |
| Description | |
| Command Mode | Global configuration mode |
| Configuration Usage | N/A. |

↘ Configuring the Name of the File for Delayed Logging

| | |
|------------------------------|--|
| Command | logging delay-send file flash:filename |
| Parameter Description | flash:filename: Indicates the name of the file on the local device where logs are buffered. |
| Command Mode | Global configuration mode |
| Configuration Usage | <p>This command is used to configure the name of the file on the local device where logs are buffered.</p> <p>The file name cannot contain any dot (.) because the system automatically adds the index and the file name extension (.txt) to the file name when generating a locally buffered file. The index increases each time a new file is generated. In addition, the file name cannot contain characters prohibited by your file system, such as \, /, :, *, ", <, >, and .</p> <p>For example, the configured file name is log_server, the current file index is 5, the file size is 1000 bytes, and the source IP address is 10.2.3.5. The name of the log file sent to the remote server is log_server_1000_10.2.3.5_5.txt while the name of the log file stored on the device is log_server_5.txt.</p> <p>If the source IP address is an IPv6 address, the colon (:) in the IPv6 address must be replaced by the hyphen (-) because the colon (:) is prohibited by the file system.</p> <p>For example, the file name is log_server, the current file index is 6, the file size is 1000 bytes, and the source IPv6 address is 2001::1. The name of the log file sent to the remote server is log_server_1000_2001-1_6.txt while the name of the log file stored on the device is log_server_6.txt.</p> |

↘ Configuring the Delayed Logging Interval

| | |
|------------------------------|--|
| Command | logging delay-send interval seconds |
| Parameter Description | seconds: Indicates the delayed logging interval. The unit is second. |
| Command Mode | Global configuration mode |
| Configuration Usage | This command is used to configure the delayed logging interval. The value ranges from 600s to 65,535s. |

↘ Configuring the Server Address and Delayed Logging Mode

| | |
|------------------------------|--|
| Command | logging delay-send server { ip-address ipv6 ipv6-address } mode { ftp user username password [0 7] password tftp } |
| Parameter Description | <p>ip-address: Indicates the IP address of the server that receives logs.</p> <p>ipv6 ipv6-address: Indicates the IPv6 address of the server that receives logs.</p> <p>username: Specifies the user name of the FTP server.</p> <p>password: Specifies the password of the FTP server.</p> <p>0: (Optional) Indicates that the following password is in plain text.</p> <p>7: Indicates that the following password is encrypted.</p> |
| Command Mode | Global configuration mode |

| | |
|----------------------------|---|
| Configuration Usage | This command is used to specify an FTP or a TFTP server for receiving the device logs. You can configure a total of five FTP or TFTP servers, but a server cannot be both an FTP and TFTP server.. Logs will be simultaneously sent to all FTP or TFTP servers. |
|----------------------------|---|

Configuration Example

Configuring Delayed Logging

| | |
|----------------------------|---|
| Scenario | It is required to configure the delayed logging function as follows: <ol style="list-style-type: none"> 1. Enable the delayed display of logs on the Console and remote terminal. 2. Set the delayed logging interval to 7200s (two hours). 3. Set the name of the file for delayed logging to syslog_ruijie. 4. Set the IP address of the server to 192.168.23.12, user name to admin, password to admin, and logging mode to FTP. |
| Configuration Steps | <ul style="list-style-type: none"> ● Configure the delayed logging function. <pre>Ruijie# configure terminal Ruijie(config)# logging delay-send terminal Ruijie(config)# logging delay-send interval 7200 Ruijie(config)# logging delay-send file flash:syslog_ruijie Ruijie(config)# logging delay-send server 192.168.23.12 mode ftp user admin password admin</pre> |
| Verification | <ul style="list-style-type: none"> ● Run the show running-config include logging delay-send command to display the configuration. ● Verify that logs are sent to the remote FTP server after the timer expires. |
| | <pre>Ruijie#show running-config include logging delay-send logging delay-send terminal logging delay-send interval 7200 logging delay-send file flash:syslog_ruijie logging delay-send server 192.168.23.12 mode ftp user admin password admin</pre> |

7.4.10 Configuring Periodical Logging

Configuration Effect

- By default, periodical logging is disabled. Periodical logging interval is 15 minutes. Periodical display of logs on the Console and remote terminal are disabled.
- You can modify the periodical logging interval. The server will collect all performance statistic logs at the time point that is the least common multiple of the intervals of all statistic objects.

Notes

- Periodical logging takes effect only when the RFC5424 format is enabled.
- The settings of the periodical logging interval and the function of displaying logs on the Console and remote terminal take effect only when the periodical logging function is enabled.
- It is recommended to disable periodical display of logs on the Console and remote terminal. Otherwise, a large amount of performance statistic logs will be displayed, increasing the burden on the device.
- To ensure the server can collect all performance statistic logs at the same time point, the timer will be restarted when you modify the periodical logging interval of a statistic object.

Configuration Steps

▾ Enabling Periodical Logging

- (Optional) By default, periodical logging is disabled.
- Unless otherwise specified, perform this configuration on the device to enable periodical logging.

▾ Enabling Periodical Display of Logs on Console and Remote Terminal

- (Optional) By default, periodical display of logs on the Console and remote terminal is disabled.
- Unless otherwise specified, perform this configuration on the device to enable periodical display of logs on the Console and remote terminal.

▾ Configuring the Periodical Logging Interval

- (Optional) By default, the periodical logging interval is 15 minutes.
- Unless otherwise specified, perform this configuration on the device to configure the interval at which logs of statistic objects are sent to the server.

Verification

- Run the **show running** command to display the configuration.

Related Commands

▾ Enabling Periodical Logging

| | |
|----------------------------|---|
| Command | logging statistic enable |
| Parameter | N/A |
| Description | |
| Command Mode | Global configuration mode |
| Configuration Usage | This command is used to enable periodical logging. After this function is enabled, the system outputs a series of performance statistics at a certain interval so that the log server can monitor the system performance. |

▾ Enabling Periodical Display of Logs on Console and Remote Terminal

| | |
|------------------------------|-----------------------------------|
| Command | logging statistic terminal |
| Parameter Description | N/A |
| Command Mode | Global configuration mode |
| Configuration Usage | N/A |

↘ **Configuring the Periodical Logging Interval**

| | |
|------------------------------|--|
| Command | logging statistic mnemonic <i>mnemonic interval minutes</i> |
| Parameter Description | <i>mnemonic</i> : Identifies a performance statistic object. <i>minutes</i> : Indicates the periodical logging interval. The unit is minute. |
| Command Mode | Global configuration mode |
| Configuration Usage | This command is used to configure the periodical logging interval for a specified performance statistic object. The interval can be set to 0, 15, 30, 60, or 120 minutes. 0 indicates that periodical logging is disabled. |

Configuration Example

↘ **Configuring Periodical Logging**

| | |
|----------------------------|--|
| Scenario | It is required to configure the periodical logging function as follows: 1. Enable the periodical logging function. 2. Enable periodical display of logs on the Console and remote terminal. 3. Set the periodical logging interval of the statistic object TUNNEL_STAT to 30 minutes. |
| Configuration Steps | <ul style="list-style-type: none"> ● Configure the periodical logging function. |
| | <pre>Ruijie# configure terminal Ruijie(config)# logging statistic enable Ruijie(config)# logging statistic terminal Ruijie(config)# logging statistic mnemonic TUNNEL_STAT interval 30</pre> |
| Verification | <ul style="list-style-type: none"> ● Run the show running-config include logging statistic command to display the configuration. ● After the periodical logging timer expires, verify that logs of all performance statistic objects are generated at the time point that is the least common multiple of the intervals of all statistic objects. |
| | <pre>Ruijie#show running-config include logging statistic logging statistic enable logging statistic terminal logging statistic mnemonic TUNNEL_STAT interval 30</pre> |

7.4.11 Configuring Syslog Monitoring

Configuration Effect

- Record login/exit attempts. After logging of login/exit attempts is enabled, the related logs are displayed on the device when users access the device through Telnet or SSH. This helps the administrator monitor the device connections.
- Record modification of device configurations. After logging of operations is enabled, the related logs are displayed on the device when users modify the device configurations. This helps the administrator monitor the changes in device configurations.

Notes

- If both the **logging userinfo** command and the **logging userinfo command-log** command are configured on the device, only the configuration result of the **logging userinfo command-log** command is displayed when you run the **show running-config** command.

Configuration Steps

↘ Enabling Logging of Login/Exit Attempts

- (Optional) By default, logging of login/exit attempts is disabled.
- Unless otherwise specified, perform this configuration on every line of the device to enable logging of login/exit attempts.

↘ Enabling logging of Operations

- (Optional) By default, logging of operations is disabled.
- Unless otherwise specified, perform this configuration on every line of the device to enable logging of operations.

Verification

- Run the **show running** command to display the configuration.

Related Commands

↘ Enabling Logging of Login/Exit Attempts

| | |
|------------------------------|---|
| Command | logging userinfo |
| Parameter Description | N/A |
| Command Mode | Global configuration mode |
| Configuration Usage | By default, a device does not generate related logs when users log into or exit the device. |

↘ Enabling Logging of Operations

| | |
|----------------|-------------------------------------|
| Command | logging userinfo command-log |
|----------------|-------------------------------------|

| | |
|------------------------------|---|
| Parameter Description | N/A |
| Command Mode | Global configuration mode |
| Configuration Usage | The system generates related logs when users run configuration commands. By default, a device does not generate logs when users modify device configurations. |

Configuration Example

Configuring Syslog Monitoring

| | |
|----------------------------|---|
| Scenario | It is required to configure the syslog monitoring function as follows: <ol style="list-style-type: none"> 1. Enable logging of login/exit attempts. 2. Enable logging of operations. |
| Configuration Steps | <ul style="list-style-type: none"> ● Configure the syslog monitoring function. <pre>Ruijie# configure terminal Ruijie(config)# logging userinfo Ruijie(config)# logging userinfo command-log</pre> |
| Verification | <ul style="list-style-type: none"> ● Run the show running-config include logging command to display the configuration. ● Run a command in global configuration mode, and verify that the system generates a log. |
| | <pre>Ruijie#configure terminal Enter configuration commands, one per line. End with CNTL/Z. Ruijie(config)#interface gigabitEthernet 0/0 *Jun 16 15:03:43: %CLI-5-EXEC_CMD: Configured from console by admin command: interface GigabitEthernet 0/0 Ruijie#show running-config include logging logging userinfo command-log</pre> |

7.4.12 Synchronizing User Input with Log Output

Configuration Effect

- By default, the user input is not synchronized with the log output. After this function is enabled, the content input during log output is displayed after log output is completed, ensuring integrity and continuity of the input.

Notes

- This command is executed in line configuration mode. You need to configure this command on every line as required.

Configuration Steps

↘ Synchronizing User Input with Log Output

- (Optional) By default, the synchronization function is disabled.
- Unless otherwise specified, perform this configuration on every line to synchronize user input with log output.

Verification

- Run the **show running** command to display the configuration.

Related Commands

↘ Synchronizing User Input with Log Output

| | |
|------------------------------|--|
| Command | logging synchronous |
| Parameter Description | N/A |
| Command Mode | Line configuration mode |
| Configuration Usage | This command is used to synchronize the user input with log output to prevent interrupting the user input. |

Configuration Example

↘ Synchronizing User Input with Log Output

| | |
|----------------------------|---|
| Scenario | It is required to synchronize the user input with log output as follows: 1. Enable the synchronization function. |
| Configuration Steps | <ul style="list-style-type: none"> ● Configure the synchronization function. |
| | <pre>Ruijie# configure terminal Ruijie(config)# line console 0 Ruijie(config-line)# logging synchronous</pre> |
| Verification | <ul style="list-style-type: none"> ● Run the show running-config begin line command to display the configuration. |
| | <pre>Ruijie#show running-config begin line line con 0 logging synchronous login local</pre> <p>As shown in the following output, when a user types in "vlan", the state of interface 0/1 changes and the related log is output. After log output is completed, the log module automatically displays the user input "vlan" so that the user can continue typing.</p> <pre>Ruijie(config)#vlan</pre> |

```
*Aug 20 10:05:19: %LINK-5-CHANGED: Interface GigabitEthernet 0/1, changed state to up
*Aug 20 10:05:19: %LINEPROTO-5-UPDOWN: Line protocol on Interface GigabitEthernet 0/1, changed
state to up
Ruijie(config)#vlan
```

7.5 Monitoring

Clearing

 Running the **clear** commands may lose vital information and thus interrupt services.

| Description | Command |
|-----------------------------------|----------------------|
| Clears logs in the memory buffer. | clear logging |

Displaying

| Description | Command |
|---|-----------------------------|
| Displays log statistics and logs in the memory buffer based on the timestamp from oldest to latest. | show logging |
| Displays log statistics and logs in the memory buffer based on the timestamp from latest to oldest. | show logging reverse |
| Displays syslog configurations and statistics. | show logging config |
| Displays log statistics of each module in the system. | show logging count |

8 Configuring RLOG

8.1 Overview

RLOG (Remote Log) is developed to export log files to remote servers (like ELOG and SNC).

With RLOG enabled, devices collect and send logs to the servers. Then, servers analyze and write logs into their libraries. Thus, it is convenient to refer to specific logs from the servers. RLOG is available to multiple types of logs concerning device running, user behavior, and system security.

 The following sections describe RLOG only.

Protocols and Standards

- N/A

8.2 Applications

| Application | Description |
|----------------------------|--|
| Log Export | With RLOG enabled, remote logs are exported to RLOG servers for reference. |

8.2.1 Log Export

Scenario

With RLOG and URL audit logging configured, the AP/AC outputs URL audit logs when users access the network through the AP. Once users go offline, the logs are sent to the ELOG server.

Figure 8-1

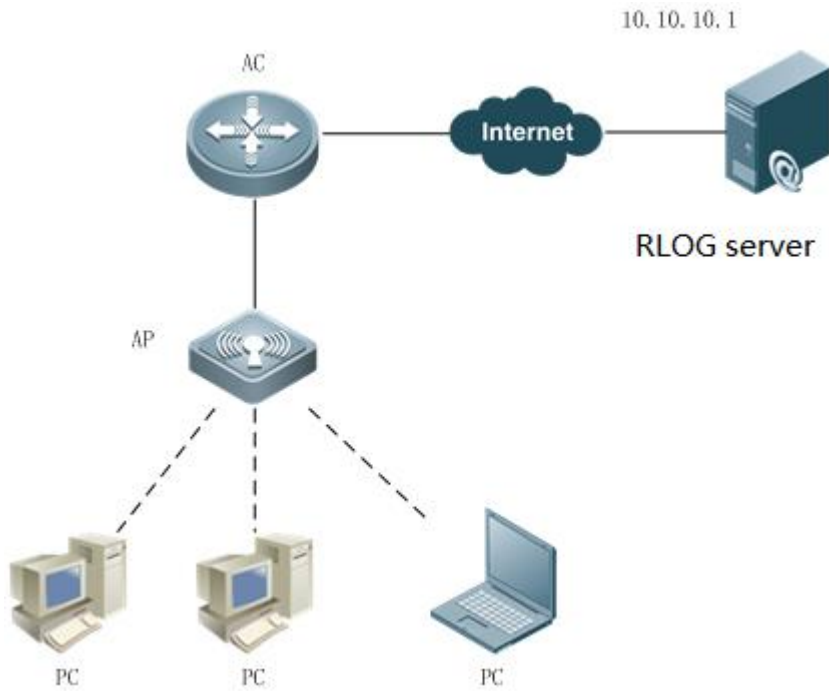

| | |
|------|---|
| Note | AP: access point AC: access controller |
|------|---|

Deployment

- Enable log modules and RLOG on the AC/AP. Configure the RLOG server.
- The RLOG server receives and analyzes logs for reference and statistics.

8.3 Features

Basic Concepts

N/A

Overview

| Function | Description |
|--------------------------------------|---|
| RLOG Export | Exports remote logs on AC/AP to RLOG servers. |
| RLOG-specific Server | Configures remote log-differentiated servers for different types of logs. |

8.3.1 Configuring RLOG Export

With this function enabled, AC/AP exports logs to RLOG servers.

Working Principle

Different log modules on AC/AP, such as flow logging, device audit logging, flow audit logging and content audit logging, generate various logs. RLOG servers receive, analyze and display these logs.

Related Configuration

↳ Enabling log modules

By default, log modules are disabled. Enable these modules at first.

For instance, use the **flow-audit enable** command to enable the flow audit log module.

↳ Enabling RLOG

By default, RLOG servers and export are not configured.

Configure an RLOG server: `rlog server 192.168.1.100 port 20000`

Configure the RLOG export: `rlog type 25 server 192.168.1.100 priority 1`

The parameter type 25 means interface flow logs.

8.3.2 Configuring RLOG-specific Export

With this function enabled, RLOG sends different sorts of logs to corresponding RLOG servers as configured.

Working Principle

According to RLOG types, export requests from log modules are handled differently.

Related Configuration

↳ Enabling log modules

By default, log modules are disabled. Enable these modules at first.

For instance, use the **flow-audit enable** command to enable the flow audit log module.

↳ Enabling RLOG-specific export

By default, RLOG servers and export are not configured.

Configure 2 RLOG servers: `rlog server 192.168.1.100 port 20000`

`rlog server 192.168.1.101 port 20000`

Configure server for flow logs: `rlog type 16 server 192.168.1.100 priority 1`

Configure server for interface flow logs: `rlog type 25 server 192.168.1.101 priority 1`

The parameter type 16 means flow logs.

8.4 Configuration

| Function | Description and Command | |
|---|---|--|
| Enable RLOG export | (Mandatory). It is used to configure the server address and port. | |
| | rlog server ip-address [vrf vrf-name] [port port-num] | Specifies the RLOG server and the VRF/MGMT port to enable RLOG export. The default port number is 20000. |
| | rlog type n server server-ip priority prio | Specifies the RLOG type and priority for a specific server |
| Configure RLOG parameters | (Optional). It is used to configure the RLOG export rate. | |
| | rlog export-rate val | Sets the RLOG export rate (export counts per second). |
| | rlog set log-com | Enables RLOG combination export. |
| | rlog dev-ip ip | Specifies the RLOG device. |
| | rlog filter acl_id | Enables the RLOG filtering. (not supported currently) |

8.4.1 Enabling RLOG

[Networking Requirements](#)

- Configure the RLOG server.
- Configure RLOG-specific export.

[Notes](#)

- N/A

[Configuration Steps](#)

↘ [Configuring RLOG servers](#)

- Mandatory
- At least one RLOG server should be configured.

↘ [Configure RLOG-specific export](#)

- Mandatory
- At least one RLOG type should be configured.

[Verification](#)

- If RLOG export is functional, check whether the RLOG server receives every log.

[Related Commands](#)

▾ Configuring the RLOG server

| | |
|------------------------------|---|
| Command | rlog server <i>ip-address</i> [vrf <i>vrf-name</i>] [port <i>port-num</i>] |
| Parameter Description | <i>ip-address</i> : IP address of the RLOG server <i>port-num</i> : Port number of the RLOG server vrf <i>vrf-name</i> : VRF name |
| Command Mode | Global configuration mode |
| Usage Guide | Configuring the RLOG server enables RLOG service. However, logs are not output without configuring relevant commands. For instance, use the ip session log-on command to enable the flow log module. Use the no rlog server ip-address to remove RLOG server configuration. |

▾ Configuring the RLOG-specific type

| | |
|------------------------------|---|
| Command | rlog type <i>n</i> server <i>server-ip</i> priority <i>prio</i> |
| Parameter Description | <i>n</i> : RLOG type <i>server-ip</i> : IP address of the RLOG server <i>prio</i> : RLOG priority (0-7). The lower the value is, the higher the priority is. |
| Command Mode | Global configuration mode |
| Usage Guide | <p>Use the no rlog type n server server-ip command to remove the configuration.</p> <p>Supported RLOG types at current are as follows:</p> <pre>[16] RLOG_TYPE_FLOW, /* flow log */ [17] RLOG_TYPE_CPU_MEM, /* CPU & memory usage log */ [18] RLOG_TYPE_DISC, /* hard disk log */ [19] RLOG_TYPE_DEV_LOG, /* device audit log */ [20] RLOG_TYPE_URL_AUDIT, /* URL audit log */ [21] RLOG_TYPE_SESSION, /* Online IP & session count log */ [22] RLOG_TYPE_IP_APP, /* IP-specific APP flow log */ [23] RLOG_TYPE_IP, /* IP-specific session count log*/ [24] RLOG_TYPE_CHANNEL, /* channel-specific flow log */ [25] RLOG_TYPE_INTERFACE, /* interface-specific flow log*/ [26] RLOG_TYPE_IP_OFFLINE, /* offline log */ [27] RLOG_TYPE_MAIL_AUDIT, /* E-mail audit log */ [28] RLOG_TYPE_TELNET_AUDIT, /* Telnet audit log */ [29] RLOG_TYPE_WEB_SEARCH_AUDIT, /* search audit log */ [30] RLOG_TYPE_WEB_BBS_AUDIT, /* web_bbs audit log */ [31] RLOG_TYPE_IM_AUDIT, /* IM audit log */ [32] RLOG_TYPE_FTP_AUDIT, /* FTP audit log */ [33] RLOG_TYPE_WEB_AUDIT, /* Web audit log */ [34] RLOG_TYPE_APP_AUDIT, /* App audit log */</pre> |

| | |
|-----------------------------|---|
| [35] RLOG_TYPE_FLOOD, | /* Flood attack detection log*/ |
| [36] RLOG_TYPE_FLOOD_CEAEm, | /* Flood attack cease log*/ |
| [37] RLOG_TYPE_SCAN, | /* Scan detection log*/ |
| [38] RLOG_TYPE_SCAN_CEAEm, | /* Scan cease log*/ |
| [39] RLOG_TYPE_ATTACK_FRAG, | /*IP fragmentation attack detection log*/ |

Configuration Example

i The following configuration example describes RLOG-related configuration only.

Configuring RLOG export for flow logs

| | |
|--|--|
| <p>Scenario Figure 8-2</p> | <p>The diagram illustrates a network setup for RLOG configuration. At the top, an AC (Access Controller) is connected to an Internet cloud. The Internet cloud is connected to an RLOG server with the IP address 10.10.10.1. Below the AC, an AP (Access Point) is connected to three PCs (two desktops and one laptop). Dashed lines indicate the connection between the AP and the PCs.</p> |
| <p>Configuration Steps</p> | <ul style="list-style-type: none"> ● Configure the RLOG server on the AC/AP. ● Enable RLOG-specific export on the AC/AP. ● Enable the flow log module. |
| <p>A</p> | <pre>A# configure terminal A(config)# rlog server 10.10.10.10 port 20000 A(config)# rlog type 16 server 10.10.10.10 priority 1 A(config)# ip session log-on</pre> |
| <p>Verification</p> | <ul style="list-style-type: none"> ● Check whether there are fresh log outputs. ● Check whether there are fresh RLOG exports. |
| <p>A</p> | <pre>A# show rlog-status log local rlog message:</pre> |

| | |
|---|---|
| | <pre> remote rlog message: [16]RLOG_TYPE_FLOW : 0 [17]RLOG_TYPE_CPU_MEM : 0 [18]RLOG_TYPE_DISC : 0 [19]RLOG_TYPE_DEV_LOG : 0 [20]RLOG_TYPE_URL_AUDIT : 0 [21]RLOG_TYPE_SESSION : 0 [22]RLOG_TYPE_IP_APP : 0 [23]RLOG_TYPE_IP : 0 [24]RLOG_TYPE_CHANNEL : 0 [25]RLOG_TYPE_INTERFACE : 0 [26]RLOG_TYPE_IP_OFFLINE : 0 [27]RLOG_TYPE_MAIL_AUDIT : 0 [28]RLOG_TYPE_TELNET_AUDIT : 0 [29]RLOG_TYPE_WEB_SEARCH_AUDIT : 0 [30]RLOG_TYPE_WEB_BBS_AUDIT : 0 [31]RLOG_TYPE_IM_AUDIT : 0 [32]RLOG_TYPE_FTP_AUDIT : 0 [33]RLOG_TYPE_WEB_AUDIT : 0 [34]RLOG_TYPE_APP_AUDIT : 0 [35]RLOG_TYPE_FLOOD : 0 [36]RLOG_TYPE_FLOOD_CEASEm : 0 [37]RLOG_TYPE_SCAN : 0 [38]RLOG_TYPE_SCAN_CEASE : 0 [39]RLOG_TYPE_ATTACK_FRAG : 0 </pre> <p>If logs are produced, the value of RLOG_TYPE_FLOW will rise.</p> |
| A | <pre> A# show rlog rlog server is enable port 20000 server 192.168.1.100 port 20000 server 10.10.10.10 rlog dev-ip 0.0.0.0 rlog export-rate 10000 rlog queue remain 10000 send log count : 0 error count : 0 errorno : 0 recv buf: 0 poll buf err: 0 push buf: 0 local buf: 0 recv err cnt: 0 depatch err cnt: 0 enable log combination: 0 </pre> <p>If export succeeds, the value of send log count will rise.</p> |

Common Errors

- Though the RLOG server is configured, the RLOG type is not specified.
- Though the RLOG server and type are configured, the log module is not enabled.

8.4.2 Configuring RLOG Parameters

Configuration Effect

- RLOG operates with a better performance.

Notes

- In case of RLOG malfunction, make sure to fully understand each command parameter before the configuration.

Configuration Steps

- Optional

Verification

- Check whether RLOG export normally and the servers receive the logs.

Related Commands

▾ Setting the RLOG export rate

| | |
|------------------------------|---|
| Command | rlog export-rate val |
| Parameter Description | val: RLOG export rate (the export maximum per second) |
| Command Mode | Global configuration mode |
| Configuration Usage | The RLOG export rate is determined by device and server performance as well as log outputs. Too low rate causes log loss; too high rate raises CPU consumption. |

▾ Enabling RLOG-combination export

| | |
|------------------------------|---|
| Command | rlog set log-com |
| Parameter Description | N/A |
| Configuration Mode | AP configuration mode/AP group configuration mode |
| Configuration Usage | With this function enabled, multiple logs are packed in one packet. Check whether the RLOG server supports this function before configuration. |

▾ Configuring the IP address of the RLOG device

| | |
|----------------|-----------------------|
| Command | rlog dev-ip ip |
|----------------|-----------------------|

| | |
|------------------------------|--|
| Parameter Description | <i>ip</i> : IP address of the RLOG device |
| Configuration Mode | Global configuration mode |
| Configuration Usage | (Optional) Specific types of logs require the IP address of RLOG device. |

▾ Configuring the RLOG filtering

| | |
|------------------------------|---|
| Command | rlog filter <i>acl_id</i> |
| Parameter Description | <i>id</i> : Access list ID |
| Configuration Mode | Global configuration mode |
| Configuration Usage | This command is not supported at current. |

Configuration Example

▾ Configuring the device IP address and the export rate

| | |
|----------------------------|---|
| Configuration Steps | |
| | <pre>Ruijie# configure terminal Ruijie(config)# rlog dev-ip 10.10.10.1 Ruijie(config)# rlog export-rate 10000 Ruijie(config)# end</pre> |
| Verification | The following example displays the configuration. |
| | <pre>Ruijie# show rlog rlog server is enable port 20000 server 192.168.1.100 port 20000 server 10.10.10.10 rlog dev-ip 10.10.10.1 rlog export-rate 10000 rlog queue remain 10000 send log count : 0 error count : 0 errorno : 0 recv buf: 0 poll buf err: 0 push buf: 0 local buf: 0 recv err cnt: 0 depatch err cnt: 0</pre> |

Common Errors

- Too low rate causes log loss.

8.5 Monitoring

Clearing Configuration

N/A

Displaying Running Status

| Command | Function |
|---|----------------------------------|
| <code>show rlog</code> | Displays the RLOG configuration. |
| <code>show rlog-type</code> | Displays the RLOG type. |
| <code>show rlog-status [server ip]</code> | Displays the RLOG server status. |
| <code>show rlog-status client</code> | Displays the RLOG module status. |
| <code>show rlog-status log</code> | Displays the RLOG count. |

Displaying Debugging Information

-  Outputting debugging information consumes system resources. Therefore, disable the debugging device immediately after use.

| Command | Function |
|------------------------------|----------------------------------|
| <code>debug rlog info</code> | Enables RLOG debugging function. |
| <code>debug rlog lib</code> | Enables RLOG library function. |

9 Configuring CWMP

9.1 Overview

CPE WAN Management Protocol (CWMP) provides a general framework of unified device management, related message specifications, management methods, and data models, so as to solve difficulties in unified management and maintenance of dispersed customer-premises equipment (CPEs), improve troubleshooting efficiency, and save O&M costs.

CWMP provides the following functions:

- **Auto configuration and dynamic service provisioning.** CWMP allows an Auto-Configuration Server (ACS) to automatically provision CPEs who initially access the network after start. The ACS can also dynamically re-configure running CPEs.
- **Firmware management.** CWMP manages and upgrades the firmware and its files of CPEs.
- **Software module management.** CWMP manages modular software according to data models implemented.
- **Status and performance monitoring.** CWMP enables CPEs to notify the ACE of its status and changes, achieving real-time status and performance monitoring.
- **Diagnostics.** The ACE diagnoses or resolves connectivity or service problems based on information from CPEs, and can also perform defined diagnosis tests.

Protocols and Standards

For details about TR069 protocol specifications, visit <http://www.broadband-forum.org/technical/trlist.php>.

Listed below are some major CWMP protocol specifications:

- TR-069_Amendment-4.pdf: CWMP standard
- TR-098_Amendment-2.pdf: Standard for Internet gateway device data model
- TR-106_Amendment-6.pdf: Standard for CPE data model
- TR-181_Issue-2_Amendment-5.pdf: Standard for CPE data model 2
- tr-098-1-4-full.xml: Definition of Internet gateway device data model
- tr-181-2-4-full.xml: Definition 2 of CPE data model 2

9.2 Applications

| Typical Application | Scenario |
|---|--|
| CWMP Network Application Scenario | Initiate CPE-ACS connection, so as to upgrade the CPE firmware, upload the configuration files, restore the configuration, and realize other features. |

9.2.1 CWMP Network Application Scenario

Application Scenario

The major components of a CWMP network architecture are CPEs, an ACS, a management center, a DHCP server, and a Domain Name System (DNS) server. The management center manages a population of CPEs by controlling the ACS on a Web browser.

Figure 9-1

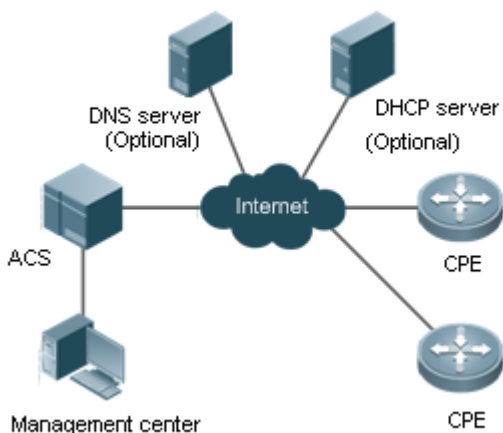

| | |
|-------------|--|
| Note | <ul style="list-style-type: none"> ● If the Uniform Resource Locator (URL) of the ACS is configured on CPEs, the DHCP server is optional. If not, the DHCP is required to dynamically discover the ACS URL. ● If the URLs of the ACS and CPEs contain IP addresses only, the DNS server is optional. If their URLs contain domain names, the DNS server is required to resolves the names. |
|-------------|--|

Functional Deployment

HTTP runs on both CPEs and the ACS.

9.3 Features

Basic Concept

Major Terminologies

- **CPE:** Customer Premises Equipment
- **ACS:** Auto-Configuration Server
- **RPC:** Remote Procedure Call
- **DM:** Data Model

Protocol Stack

Figure 9-2 shows the protocol stack of CWMP.

Figure 9-2 CWMP Protocol Stack

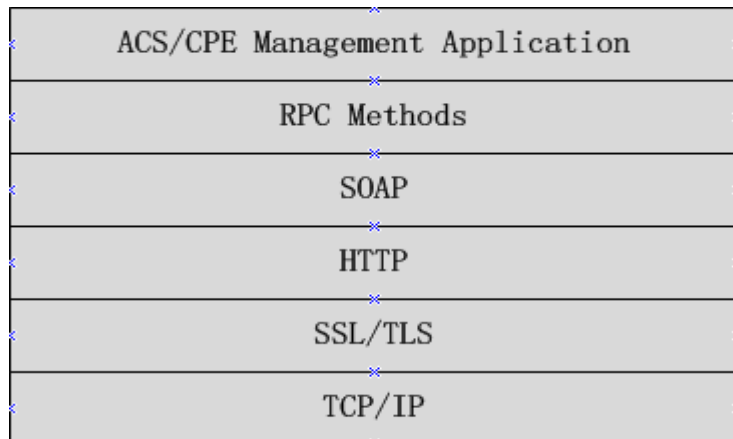

As shown in Figure 9-2, CWMP defines six layers with respective functions as follows:

- ACS/CPE Application

The application layer is not a part of CWMP. It is the development performed by various modules of the CPEs/ACS to support CWMP, just like the Simple Network Management Protocol (SNMP), which does not cover the MIB management of functional modules.

- RPC Methods

This layer provides various RPC methods for interactions between the ACS and the CPEs.

- SOAP

The Simple Object Access Protocol (SOAP) layer uses a XML-based syntax to encode and decode CWMP messages.. Thus, CWMP messages must comply with the XML-based syntax.

- HTTP

All CWMP messages are transmitted over Hypertext Transfer Protocol (HTTP). Both the ACS and the CPEs can behave in the role of HTTP clients and servers. The server function is used to monitor reverse connections from the peer.

- SSL/TLS

The Secure Sockets Layer (SSL) or Transport Layer Security (TLS) layer guarantees CWMP security, including data integrity, confidentiality, and authentication.

- TCP/IP

This layer is the (Transmission Control Protocol/Internet Protocol (TCP/IP) protocol stack.

RPC Methods

The ACS manages and monitors CPEs by calling mostly the following RPC methods:

- Get RPC Methods

The Get methods enable the ACS to remotely obtain the set of RPC methods, as well as names, values and attributes of the DM parameters supported on CPEs.

- Set RPC Methods

The Set methods enable the ACS to remotely set the values and attributes of the DM parameters supported on CPEs.

- Inform RPC Methods

The Inform methods enable CPEs to inform the ACS of their device identifiers, parameter information, and events whenever sessions are established between them.

- Download RPC Methods

The Download method enables the ACS to remotely control the file download of CPEs, including firmware management, upgrade, and Web package upgrade.

- Upload RPC Methods

The Upload method enables the ACS to remotely control the file upload of CPEs, including upload of firmware and logs.

- Reboot RPC Methods

The Reboot method enables the ACS to remotely reboot the CPEs.

▾ Session Management

CWMP sessions or interactions are the basis for CWMP. All CWMP interactions between the ACS and CPEs rely on their sessions. CWMP helps initiate and maintain ACS-CPE sessions to link them up for effective management and monitoring. An ACS-CPE session is a TCP connection, which starts from the Inform negotiation to TCP disconnection. The session is classified into CPE Initiated Session and ACS Initiated Session according to the session poster.

▾ DM Management

CWMP operates based on CWMP Data Model (DM). CWMP manages all functional modules by a set of operations performed on DM. Each functional module registers and implements a respective data model, just like the MIBs implemented by various functional modules of SNMP.

A CWMP data model is represented in the form of a character string. For a clear hierarchy of the data model, a dot (.) is used as a delimiter to distinguish an upper-level data model node from a lower-level data model node. For instance, in the data model **InternetGatewayDevice.LANDevice**, **InternetGatewayDevice** is the parent data model node of **LANDevice**, and **LANDevice** is the child data model node of **InternetGatewayDevice**.

DM nodes are classified into two types: object nodes and parameter nodes. The parameter nodes are also known as leaf nodes. An object node is a node under which there are child nodes, and a parameter node is a leaf node under which there is no any child node. Object nodes are further classified into single-instance object nodes and multi-instance object nodes. A single-instance object node is an object node for which there is only one instance, whereas a multi-instance object node is an object node for which there are multiple instances.

DM nodes can also be classified into readable nodes and readable-and-writable nodes. A readable node is a node whose parameter values can be read but cannot be modified, and a readable-and-writable node is a node whose parameter values can be both read and modified.

A data model node has two attributes. One attribute relates to a notification function; that is, whether to inform the ACS of changes (other than changes caused by CWMP) to parameter values of the data model. The other attribute is an identifier indicating that the parameters of the data model node can be written using other management modes (than the ACS); that is, whether the values of the parameters can be modified using other management modes such as Telnet. The ACS can modify the attributes of the data models using RPC methods.

CWMP manages the data models using corresponding RPC methods.

↳ Event Management

When some events concerned by the ACS occur on the CPE, the CPE will inform the ACS of these events. The ACS monitors these events to monitor the working status of the CPE. The CWMP events are just like Trap messages of SNMP or product logs. Using RPC methods, to the ACS filters out the unconcerned types of events. CWMP events are classified into two types: single or (not cumulative) events and multiple (cumulative) events. A single event means that there is no quantitative change to the same event upon re-occurrence of the event, with the old discarded and the newest kept. A multiple event means that the old are not discarded and the newest event is kept as a complete event when an event re-occurs for multiple times later; that is, the number of this event is incremented by 1.

All events that occur on the CPE are notified to the ACS using the INFORM method.

Features

| Feature | Description |
|---|--|
| Upgrading the Firmware | The ACS controls the upgrade of the firmware of a CPE using the Download method. |
| Upgrading the Configuration Files | The ACS controls the upgrade of the configuration files of a CPE using the Download method. |
| Uploading the Configuration Files | The ACS controls the upload of the configuration files of a CPE using the Upload method. |
| Backing up and Restoring a CPE | When a CPE breaks away from the management center, this feature can remotely restore the CPE to the previous status. |

9.3.1 Upgrading the Firmware

Upgrading the Firmware means the firmware of a network element (NE) can be upgraded, so as to implement device version upgrade or replacement.

Working Principle

↳ Sequence Diagram of Upgrading the Firmware

Figure 9-3

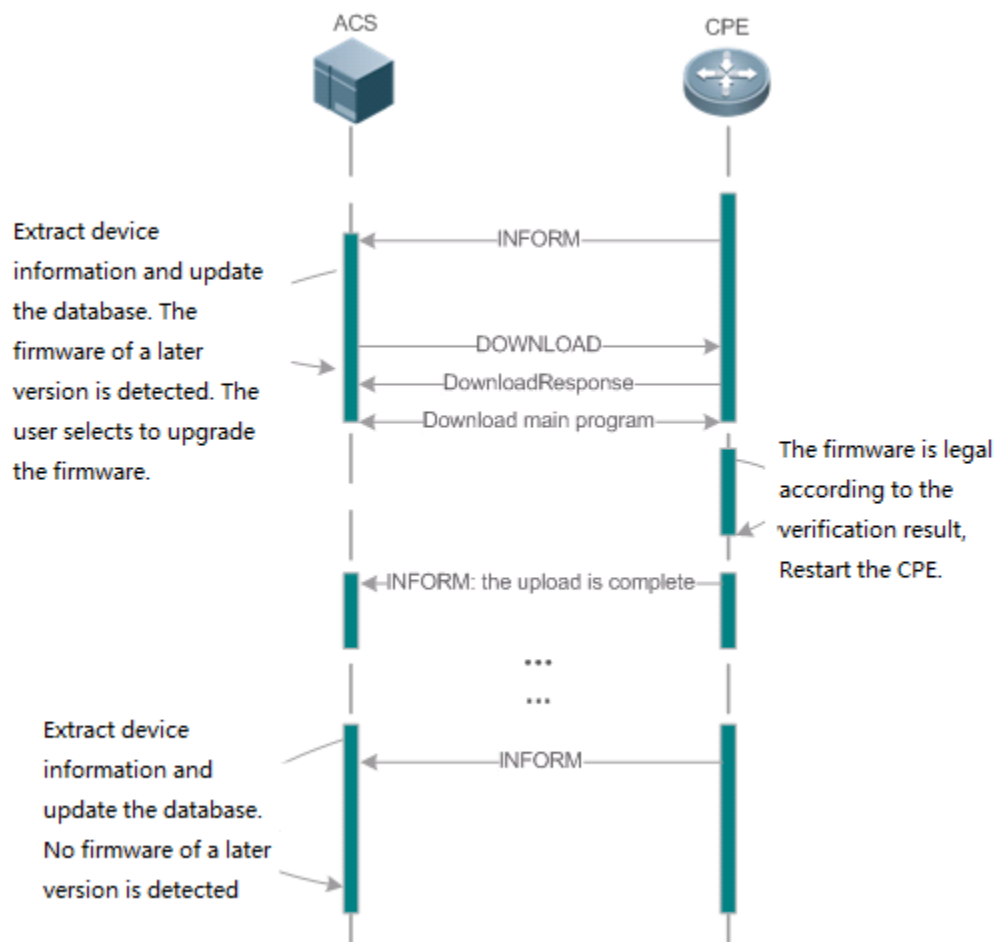

Users specify a CPE for the ACS to deliver the Download method for upgrading the firmware. The CPE receives the request and starts to download the latest firmware from the destination file server, upgrade the firmware, and then reboot. After restart, the CPE will indicate the successful or unsuccessful completion of the method application.

i The file server can be ACS or separately deployed.

9.3.2 Upgrading the Configuration Files

Upgrading the Configuration Files means the current configuration files of a CPE can be replaced with specified configuration files, so that the new configuration files act on the CPE after reset.

Working Principle

Figure 9-4

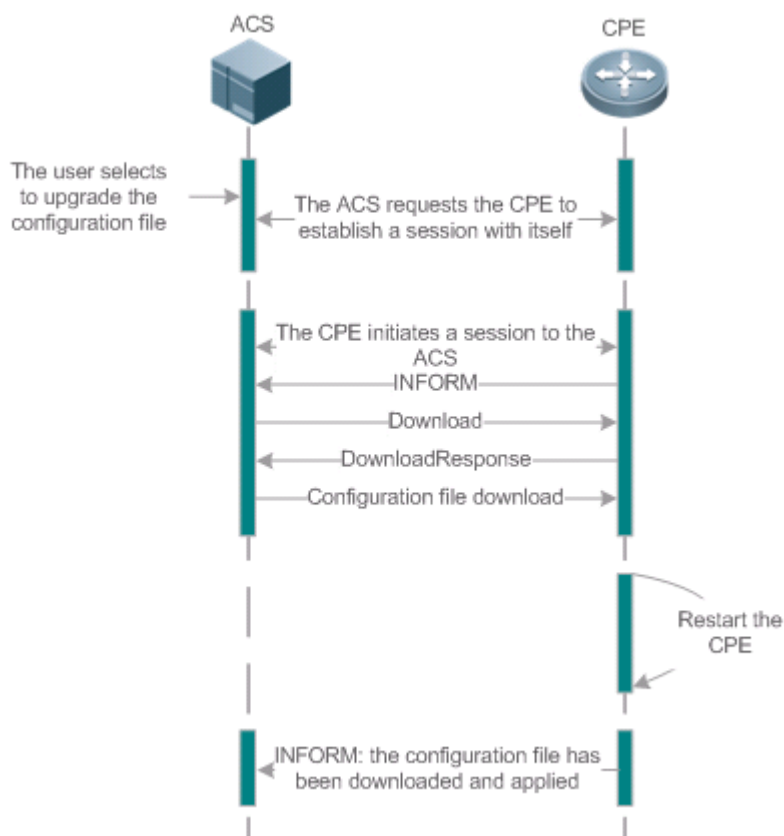

Users specify a CPE for the ACS to deliver the Download methods for upgrading its configuration files. The CPE downloads the configuration files from the specified file server, upgrade configuration files, and then reboot. After that, the CPE will indicate successful or unsuccessful completion of the method application.

i The file server can be ACS or separately deployed.

9.3.3 Uploading the Configuration Files

Uploading the Configuration Files means the ACS controls the configuration files of CPEs by using the Upload method.

Working Principle

Figure 9-5

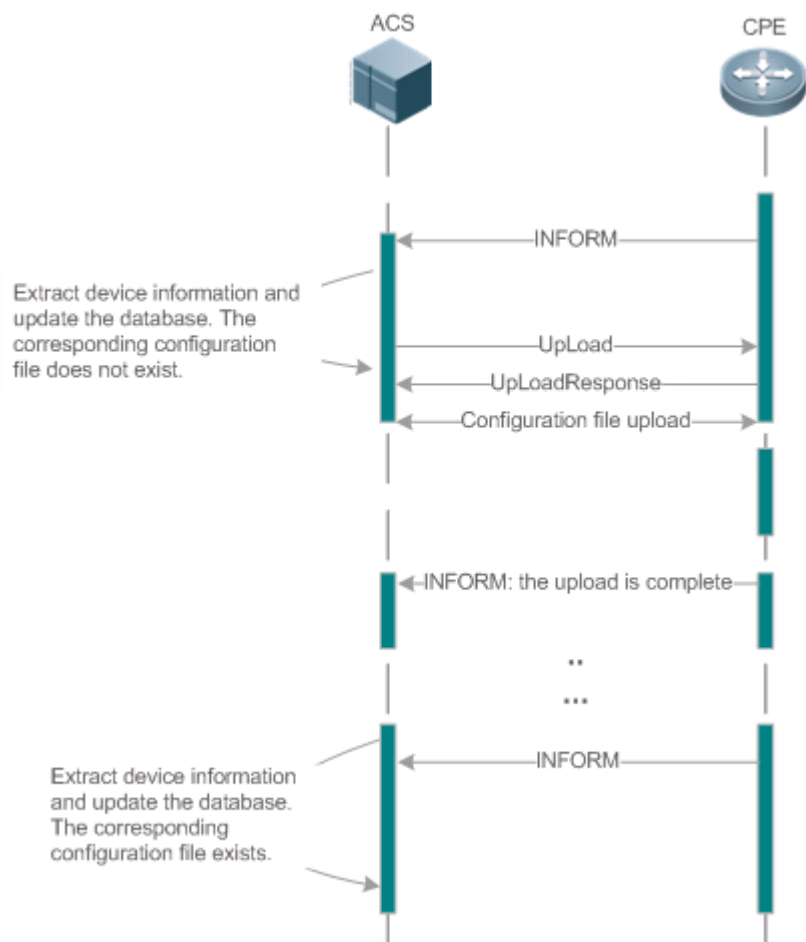

When a CPE initially accesses the ACS, the ACS attempts to learn the configuration files of the CPE in the following sequence:

- When the ACS initially receives an Inform message from the CPE, it locates the corresponding database information according to device information carried in the message.
- If the database does not contain the configuration files of the CPE, the ACS delivers the Upload method to the CPE for uploading the configuration files.
- The CPE uploads its current configuration files to the ACS.
- The CPE returns a successful or unsuccessful response to the Upload request.

9.3.4 Backing Up and Restoring a CPE

When a remote CPE breaks away from the management center due to abnormal operations, the CPE backup and restoration feature helps restore the CPE to the previous status, so that the management center can resume the supervision of the CPE as necessary.



Working Principle

You can configure the restoration function on a CPE, so that the CPE can restore itself from exceptions of its firmware or

configuration files. Then when the CPE fails to connect to the ACS and breaks away from the management center after its firmware or configuration files are upgraded, the previous firmware or configuration files of the CPE can be restored in time for the ACS to manage the CPE. This kind of exception is generally caused by delivery of a wrong version or configuration file.

Before the CPE receives a new firmware or configuration files to upgrade, the CPE will back up its current version and configuration files. In addition, there is a mechanism for determining whether the problem described in the preceding scenario has occurred. If the problem has occurred, the CPE is restored to the previous manageable status.

9.4 Configuration

| Action | Suggestions and Related Commands | |
|--|---|--|
| Establishing a Basic CWMP Connection |  (Mandatory) You can configure the ACS or CPE usernames and passwords to be authenticated for CWMP connection. | |
| | cwmp | Enables CWMP and enters CWMP configuration mode. |
| | acs username | Configures the ACS username for CWMP connection. |
| | acs password | Configures the ACS password for CWMP connection. |
| | cpe username | Configures the CPE username for CWMP connection. |
| | cpe password | Configures the CPE password for CWMP connection. |
| |  (Optional) You can configure the URLs of the CPE and the ACS. | |
| | acs url | Configures the ACS URL. |
| cpe url | Configures the CPE URL. | |
| Configuring CWMP-Related Attributes |  (Optional) You can configure the basic functions of the CPE, such as upload, backup and restoration of firmware, configuration files or logs. | |
| | cpe inform | Configures the periodic notification function of the CPE. |
| | cpe back-up | Configures the backup and restoration of the firmware and configuration file of the CPE. |
| | disable download | Disables the function of downloading firmware and configuration files from the ACS. |
| | disable upload | Disables the function of uploading configuration and log files to the ACS. |

| Action | Suggestions and Related Commands | |
|--------|----------------------------------|--|
| | <code>timer cpe- timeout</code> | Configures the ACS response timeout on CPEs. |

9.4.1 Establishing a Basic CWMP Connection

Configuration Effect

- A session connection is established between the ACS and the CPE.

Precautions

- N/A

Configuration Method

▾ Enabling CWMP and Entering CWMP Configuration Mode

- (Mandatory) The CWMP function is enabled by default.

| | |
|------------------------------|-----------------------------|
| Command | <code>cwmp</code> |
| Parameter Description | N/A |
| Defaults | CWMP is enabled by default. |
| Command Mode | Global configuration guide |
| Usage Guide | N/A |

▾ Configuring the ACS Username for CWMP Connection

- This configuration is mandatory on the ACS.
- Only one username can be configured for the ACS. If multiple are configured, the latest configuration is applied.

| | |
|------------------------------|--|
| Command | <code>acs username <i>username</i></code> |
| Parameter Description | <code>username <i>username</i></code> : The ACS username for CWMP connection |
| Defaults | The ACS username is not configured by default. |
| Command Mode | CWMP configuration mode |
| Usage Guide | N/A |

▾ Configuring the ACS Password for CWMP Connection

- This configuration is mandatory on the ACS.
- The password of the ACS can be in plaintext or encrypted form. Only one password can be configured for the ACS. If multiple are configured, the latest configuration is applied.

| | |
|------------------------------|--|
| Command | acs password { <i>password</i> <i>encryption-type encrypted-password</i> } |
| Parameter Description | <i>password</i> : ACS password <i>encryption-type</i> : 0 (no encryption) or 7 (simple encryption) <i>encrypted-password</i> : Password text |
| Defaults | <i>encryption-type</i> : 0 <i>encrypted-password</i> : N/A |
| Command Mode | CWMP configuration mode |
| Usage Guide | N/A |

▾ **Configuring the CPE Username for CWMP Connection**

- This configuration is mandatory on the CPE.
- Only one username can be configured for the CPE. If multiple are configured, the latest configuration is applied.

| | |
|------------------------------|---|
| Command | cpe username <i>username</i> |
| Parameter Description | <i>username</i> : CPE username |
| Defaults | No CPE username is configured by default. |
| Command Mode | CWMP configuration mode |
| Usage Guide | N/A |

▾ **Configuring the CPE Password for CWMP Connection**

- This configuration is mandatory on the CPE.
- The password of the CPE can be in plaintext or encrypted form. Only one password can be configured for the CPE. If multiple are configured, the latest configuration is applied.

| | |
|------------------------------|---|
| Command | cpe password { <i>password</i> <i>encryption-type encrypted-password</i> } |
| Parameter Description | <i>password</i> : CPE password <i>encryption-type</i> : 0 (no encryption) or 7 (simple encryption) <i>encrypted-password</i> : Password text |
| Defaults | <i>encryption-type</i> : 0 <i>encrypted-password</i> : N/A |
| Command Mode | CWMP configuration mode |
| Usage Guide | Use this command to configure the CPE user password to be authenticated for the ACS to connect to the CPE. In general, the encryption type does not need to be specified. The encryption type needs to be specified only when copying and pasting the encrypted password of this command. A valid password should meet the following format requirements: <ul style="list-style-type: none"> ● Contain 1 to 26 characters including letters and figures. ● The leading spaces will be ignored, while the trailing and middle are valid. |

| | |
|--|---|
| | <ul style="list-style-type: none"> ● If 7 (simple encryption) is specified, the valid characters only include 0 to 9 and a (A) to f (F). |
|--|---|

↘ **Configuring the ACS URL for CMWP Connection**

- This configuration is optional on the CPE.
- Only one ACS URL can be configured. If multiple are configured, the latest configuration is applied. The ACS URL must be in HTTP format.

| | |
|------------------------------|--|
| Command | <code>acs url url</code> |
| Parameter Description | <i>url</i> : ACS URL |
| Defaults | No ACS URL is configured by default. |
| Command Mode | CWMP configuration mode |
| Usage Guide | <p>If the ACS URL is not configured but obtained through DHCP, CPEs will use this dynamic URL to initiate connection to the ACS. The ACS URL must:</p> <ul style="list-style-type: none"> ● Be in format of http://host[:port]/path or https://host[:port]/path. ● Contain 256 characters at most. |

↘ **Configuring the CPE URL for CWMP Connection**

- This configuration is optional on the CPE.
- Only one CPE URL can be configured. If multiple are configured, the latest configuration is applied. The CPE URL must be in HTTP format instead of domain name format.

| | |
|------------------------------|---|
| Command | <code>cpe url url</code> |
| Parameter Description | <i>url</i> : CPE URL |
| Defaults | No CPE URL is configured by default. |
| Command Mode | CWMP configuration mode |
| Usage Guide | <p>If CPE URL is not configured, it is obtained through DHCP. The CPE URL must:</p> <ul style="list-style-type: none"> ● Be in format of http://ip [: port]/. ● Contain 256 characters at most. |

Verification

- Run the **show cwmp configuration** command.

| | |
|------------------------------|--------------------------------------|
| Command | <code>show cwmp configuration</code> |
| Parameter Description | N/A |
| Command Mode | Privileged EXEC mode |
| Usage Guide | N/A |

| | |
|-------------------------------|---|
| Configuration Examples | <p>The following example displays the CWMP configuration.</p> <pre>Ruijie(config-cwmp)#show cwmp configuration CWMP Status : enable ACS URL : http://www.ruijie.com.cn/acs ACS username : admin ACS password : ***** CPE URL : http://10.10.10.2:7547/ CPE username : ruijie CPE password : ***** CPE inform status : disable CPE inform interval : 60s CPE inform start time : 0:0:0 0 0 0 CPE wait timeout : 50s CPE download status : enable CPE upload status : enable CPE back up status : enable CPE back up delay time : 60s</pre> |
|-------------------------------|---|

Configuration Examples

i The following configuration examples describe CWMP-related configuration only.

Configuring Usernames and Passwords on the CPE

| | |
|--|--|
| Network Environment Figure 9-6 |  <p>The diagram shows a server icon labeled 'ACS' connected to a cloud icon labeled 'Internet', which is in turn connected to a router icon labeled 'CPE'.</p> |
| Configuration Method | <ul style="list-style-type: none"> ● Enable CWMP. ● On the CPE, configure the ACS username and password to be authenticated for the CPE to connect to the ACS. ● On the CPE, configure the CPE username and password to be authenticated for the ACS to connect to the CPE. |
| CPE | <pre>Ruijie# configure terminal Enter configuration commands, one per line. End with CNTL/Z. Ruijie(config)# cwmp Ruijie(config-cwmp)# acs username USERB Ruijie(config-cwmp)# acs password PASSWORDB Ruijie(config-cwmp)# cpe username USERB Ruijie(config-cwmp)# cpe password PASSWORDB</pre> |
| Verification | <ul style="list-style-type: none"> ● Run the show command on the CPE to check whether the configuration commands have been successfully applied. |

| | |
|------------|---|
| CPE | <pre>Ruijie # show cwmp configuration CWMP Status : enable ACS URL : http://10.10.10.1:7547/acs ACS username : USERA ACS password : ***** CPE URL : http://10.10.10.2:7547/ CPE username : USERB CPE password : *****</pre> |
|------------|---|

↘ Configuring the URLs of the ACS and the CPE

| | |
|-----------------------------|---|
| Network Environment | See Figure 8-6. |
| Configuration Method | <ul style="list-style-type: none"> ● Configure the ACS URL. ● Configure the CPE URL. |
| CPE | <pre>Ruijie# configure terminal Ruijie(config)# cwmp Ruijie(config-cwmp)# acs url http://10.10.10.1:7547/acs Ruijie(config-cwmp)# cpe url http://10.10.10.1:7547/</pre> |
| Verification | Run the show command on the CPE to check whether the configuration commands have been successfully applied. |
| CPE | <pre>Ruijie #show cwmp configuration CWMP Status : enable ACS URL : http://10.10.10.1:7547/acs ACS username : USERA ACS password : ***** CPE URL : http://10.10.10.2:7547/</pre> |

Common Errors

- The user-input encrypted password is longer than 254 characters, or the length of the password is not an even number.
- The user-input plaintext password is longer than 100 characters.
- The user-input plaintext password contains illegal characters.
- The user-input encrypted password contains illegal characters (the legitimate characters includes only 0~9, a~f and A~F)
- The URL of the ACS is set to **NULL**.
- The URL of the CPE is set to **NULL**.

9.4.2 Configuring CWMP-Related Attributes

Configuration Effect

- You can configure common functions of the CPE, such as the backup and restoration of its firmware or configuration file, whether to enable the CPE to download firmware and configuration files from the ACS, and whether to enable the CPE to upload its configuration and log files to the ACS.

Configuration Method

▾ Configuring the Periodic Notification Function of the CPE

- (Optional) The value range is from 30 to 3,600 in seconds. The default value is 600 seconds.
- Perform this configuration to reset the periodical notification interval of the CPE.

| | |
|------------------------------|---|
| Command | cpe inform [interval seconds] [starttime time] |
| Parameter Description | <i>seconds</i> : Specifies the periodical notification interval of the CPE. The value range is from 30 to 3,600 in seconds. <i>time</i> : Specifies the date and time for starting periodical notification in <i>yyyy-mm-ddThh:mm:ss</i> format. |
| Command Mode | CWMP configuration mode |
| Defaults | The default value is 600 seconds. |
| Usage Guide | Use this command to configure the periodic notification function of the CPE. <ul style="list-style-type: none"> ● If the time for starting periodical notification is not specified, periodical notification starts after the periodical notification function is enabled. The notification is performed once within every notification interval. ● If the time for starting periodical notification is specified, periodical notification starts at the specified start time. For instance, if the periodical notification interval is set to 60 seconds and the start time is 12:00 am next day, periodical notification will start at 12:00 am next day and once every 60 seconds. |

▾ Disabling the Function of Downloading Firmware and Configuration Files from the ACS

- (Optional) The CPE can download firmware and configuration files from the ACS by default.
- Perform this configuration if the CPE does not need to download firmware and configuration files from the ACS.

| | |
|------------------------------|--|
| Command | disable download |
| Parameter Description | N/A |
| Defaults | The CPE can download firmware and configuration files from the ACS by default. |
| Command Mode | CWMP configuration mode |
| Usage Guide | Use this command to disable the function of downloading main program and configuration files from the ACS. <ul style="list-style-type: none"> ● This command does not act on configuration script files. The configuration scripts can still be executed even if this function is disabled. |

▾ Disabling the Function of Uploading Configuration and Log Files to the ACS

- (Optional.) The CPE can upload configuration and log files to the ACS by default.

- Perform this configuration if the CPE does not need to upload configuration and log files to the ACS.

| | |
|------------------------------|---|
| Command | disable upload |
| Parameter Description | N/A |
| Defaults | The CPE can upload configuration and log files to the ACS by default. |
| Command Mode | CWMP configuration mode |
| Usage Guide | Use this command to disable the function of uploading configuration and log files to the ACS. |

▾ **Configuring the Backup and Restoration of the Firmware and Configuration Files of the CPE**

- (Optional) The backup and restoration of the firmware and configuration files of the CPE is enabled by default. The value range is from 30 to 10,000 in seconds. The default value is 60 seconds.
- The longer the delay-time is, the longer the reboot will be complete.
- Perform this configuration to modify the function of backing up and restoring the firmware and configuration files of the CPE.

| | |
|------------------------------|--|
| Command | cpe back-up [delay-time seconds] |
| Parameter Description | <i>seconds</i> : Specifies the delay for backup and restoration of the firmware and configuration file of the CPE. |
| Defaults | The default value is 60 seconds. |
| Command Mode | CWMP configuration mode |
| Usage Guide | N/A |

▾ **Configuring the ACS Response Timeout**

- (Optional) The value range is from 5 to 600 in seconds. The default value is 5 seconds.
- Perform this configuration to modify the ACS response timeout period on the CPE.

| | |
|------------------------------|---|
| Command | timer cpe- timeout seconds |
| Parameter Description | <i>seconds</i> : Specifies the timeout period in seconds. The value range is from 5 to 600. |
| Defaults | The default value is 5 seconds. |
| Command Mode | CWMP configuration mode |
| Usage Guide | N/A |

Verification

- Run the show cwmp configuration command.

| | |
|----------------|--------------------------------|
| Command | show cwmp configuration |
|----------------|--------------------------------|

| | |
|-------------------------------|---|
| Parameter Description | N/A |
| Command Mode | Privileged EXEC mode |
| Usage Guide | N/A |
| Configuration Examples | <p>The following example displays the CWMP configuration.</p> <pre>Ruijie(config-cwmp)#show cwmp configuration CWMP Status : enable ACS URL : http://www.ruijie.com.cn/acs ACS username : admin ACS password : ***** CPE URL : http://10.10.10.2:7547/ CPE username : ruijie CPE password : ***** CPE inform status : disable CPE inform interval : 60s CPE inform start time : 0:0:0 0 0 0 CPE wait timeout : 50s CPE download status : enable CPE upload status : enable CPE back up status : enable CPE back up delay time : 60s</pre> |

Configuration Examples

Configuring the Periodical Notification Interval of the CPE

| | |
|----------------------------|---|
| Network Environment | See Figure 8-6. |
| Configuration Steps | <ul style="list-style-type: none"> ● Enable the CWMP function and enter CWMP configuration mode. ● Set the periodical notification interval of the CPE to 60 seconds. |
| CPE | <pre>Ruijie#config Enter configuration commands, one per line. End with CNTL/Z. Ruijie(config)#cwmp Ruijie(config-cwmp)#cpe inform interval 60</pre> |
| Verification | Run the show command on the CPE to check whether the configuration commands have been successfully applied. |
| CPE | <pre>Ruijie #show cwmp configuration CWMP Status : enable CPE inform interval : 60s</pre> |

▾ **Disabling the Function of Downloading Firmware and Configuration Files from the ACS**

| | |
|----------------------------|---|
| Network Environment | See Figure 8-6. |
| Steps | <ul style="list-style-type: none"> ● Enable the CWMP function and enter CWMP configuration mode. ● Disable the function of downloading firmware and configuration files from the ACS. |
| CPE | <pre>Ruijie#config Enter configuration commands, one per line. End with CNTL/Z. Ruijie(config)#cwm Ruijie(config-cwm)#disable download</pre> |
| Verification | Run the show command on the CPE to check whether the configuration commands have been successfully applied. |
| CPE | <pre>Ruijie #show cwm configuration CWMP Status : enable CPE download status : disable</pre> |

▾ **Disabling the Function of Uploading Configuration and Log Files to the ACS**

| | |
|----------------------------|--|
| Network Environment | See Figure 8-6. |
| Configuration Steps | <ul style="list-style-type: none"> ● Enable the CWMP function and enter CWMP configuration mode. ● Disable the CPE's function of uploading configuration and log files to the ACS. |
| CPE | <pre>Ruijie#config Enter configuration commands, one per line. End with CNTL/Z. Ruijie(config)#cwm Ruijie(config-cwm)# disable upload</pre> |
| Verification | Run the show command on the CPE to check whether the configuration commands have been successfully applied. |
| CPE | <pre>Ruijie #show cwm configuration CWMP Status : enable CPE upload status : disable</pre> |

▾ **Configuring the Backup and Restoration Delay**

| | |
|----------------------------|---|
| Network Environment | See Figure 8-6. |
| Configuration Steps | <ul style="list-style-type: none"> ● Enable the CWMP function and enter CWMP configuration mode. ● Set the backup and restoration delay to 100 seconds. |
| CPE | <pre>Ruijie#config Enter configuration commands, one per line. End with CNTL/Z. Ruijie(config)#cwmp Ruijie(config-cwmp)# cpe back-up Seconds 30</pre> |
| Verification | <ul style="list-style-type: none"> ● Run the show command on the CPE to check whether the configuration commands have been successfully applied. |
| CPE | <pre>Ruijie #show cwmp configuration CWMP Status : enable CPE back up delay time : 30s</pre> |

📌 **Configuring the ACS Response Timeout of the CPE**

| | |
|----------------------------|--|
| Network Environment | See Figure 8-6. |
| Configuration Steps | <ul style="list-style-type: none"> ● Enable the CWMP function and enter CWMP configuration mode. ● Set the response timeout of the CPE to 100 seconds. |
| CPE | <pre>Ruijie# configure terminal Enter configuration commands, one per line. End with CNTL/Z. Ruijie(config)# cwmp Ruijie(config-cwmp)# timer cpe-timeout 100</pre> |
| Verification | <ul style="list-style-type: none"> ● Run the show command on the CPE to check whether the configuration commands have been successfully applied. |
| CPE | <pre>Ruijie#show cwmp configuration CWMP Status : enable CPE wait timeout : 100s</pre> |

Common Errors

N/A

9.5 Monitoring

Displaying

| Command | Function |
|---------|----------|
|---------|----------|

| | |
|--------------------------------|-----------------------------------|
| show cwmp configuration | Displays the CWMP configuration. |
| show cwmp status | Displays the CWMP running status. |

10 Configuring LED

10.1 Overview

Light Emitting Diode (LED) is a solid luminous semiconductor. It serves as an indicator light to show AP's working status in different colors.

 The following part only introduces LED.

Protocols and Standards

N/A

10.2 Application

N/A

10.3 Features

Ruijie products support one or multiple LEDs to display AP's working status. For example, the LED on an Ethernet interface blink when there comes the data flow. It is controlled through GPIO or CPLD ports with different lighting, such as solid green, blinking green, blinking red and so on. By observing the LED, you can easily tell AP's working status and faults.

10.4 Configuration

| Configuration Item | Configuration Suggestion & Relevant Command | | |
|---|--|---------------------------------|------------------------|
| Configuring Quiet Mode. |  (Optional). It is used to enable LED quiet mode. | | |
| | <table border="1"> <tr> <td><code>quiet-mode session</code></td> <td>Enable LED quiet mode.</td> </tr> </table> | <code>quiet-mode session</code> | Enable LED quiet mode. |
| <code>quiet-mode session</code> | Enable LED quiet mode. | | |

10.4.1 Configuring Quiet Mode

Configuration Effect

- All LEDs on an AP are off when this command takes effect.

Notes

- You must configure the effective time for the quiet mode at first.

Configuration Method

▾ **Configuring session**

- Optional configuration.
- Create a session before the configuration of the quiet mode.
- Configure the effective time for the session.

| | |
|------------------------------|--|
| Command | schedule session <i>sid</i> time-range <i>n</i> period <i>day1</i> [to <i>day2</i>] time <i>hh1:mm1</i> to <i>hh2:mm2</i> |
| Parameter Description | <p><i>sid</i>: scheduled session ID.</p> <p><i>n</i>: scheduled session period No.</p> <p><i>day1</i>: scheduled session period; day 1 indicates the start date, in the range of { sun mon tue wed thu fri sat }.</p> <p>to <i>day2</i>: the end date, only one day of the interval by default.</p> <p>time <i>hh1:mm1</i> to <i>hh2:mm2</i>: scheduled session time. hh1:mm1 is the start time and hh2:mm2 the end time in the range from 0 to 23 hours and 0 to 59 minutes.</p> |
| Defaults | N/A |
| Command Mode | Global configuration mode |
| Usage Guide | Configure a session at first. |

▾ **Configuring Quiet Mode**

- Optional configuration.
- Configuring LED quiet mode.

| | |
|------------------------------|--|
| Command | quiet-mode session <i>session-num</i> |
| Parameter Description | <i>session-num</i> : specifies the session ID. |
| Default Configuration | This function is disabled by default. |
| Configuration Mode | AP configuration mode |
| Usage Guide | Configure a session at first. |

Check Method

- All LEDs are off when the system time is within the session interval.

Configuration Examples

▾ **Configuring LED Quiet Mode from Monday 11pm to Tuesday 7am Every Week**

| | |
|----------------------------|---|
| Configuration Steps | <ul style="list-style-type: none"> ● Configure a session. ● The following example configures the session ID for the quiet mode. |
| | <pre>Ruijie# configure terminal Ruijie(config)#schedule session 1 Ruijie(config)#schedule session 1 time-range 1 period Mon time 23:00 to 7:00 Ruijie(config)#ap-config 00d0.f822.33bc Ruijie(config-ap)#quiet-mode session 1</pre> |
| Verification | When the system time is within the session interval, all LEDs on the AP are off. |

Common Mistakes

- Configured session ID does not exist.

10.5 Monitoring

N/A

11 Configuring USB

11.1 Overview

Universal serial bus (USB) is an external bus standard. In this document, USB refers to a USB-compliant peripheral device, for example, a USB flash drive.

USB is a hot swappable device. You can use it to copy files (such as configuration and log files) from a communication device, or copy external data (such as system upgrade files) to the flash of the communication device.

Specific application scenarios of the USB are detailed in configuration guides of related functions. This document describes only how to identify, use, and remove the USB and view information about the USB.

11.2 Applications

| Application | Description |
|---|--|
| Using a USB Flash Drive to Upgrade a Device | Upgrade files are stored on a USB flash drive. After a device is powered on, the device detects the USB flash drive and runs the upgrade command to load the upgrade files. After loading is completed, the device is reset and runs the upgraded version. |

11.2.1 Using a USB Flash Drive to Upgrade a Device

Scenario

Upgrade files are stored on a USB flash drive. After a device is powered on, the device detects the USB flash drive and runs the upgrade command to load the upgrade files. After loading is completed, the device is reset and runs the upgraded version. An example of the upgrade command is as follows:

```
upgrade usb0:/s12k-ppc_11.0(1B2)_20131025_main_install.bin
```

If the file is valid and execution of this command succeeds, the device will be automatically reset and run the upgraded version.

Deployment

- Use the prefix "usb0:/" to access USB 0. Run the **show usb** command to display information about the USB with the ID 0.
- Run the **upgrade** command to perform upgrade.

11.3 Features

▾ Using the USB

Insert a USB into the USB slot. The system automatically searches for the USB. After the USB is located, the driver module automatically initializes the driver of the USB. After initialization, the system automatically loads the file system on the USB. Later, the system can read or write this USB.

- If the system finds a USB and successfully loads the driver, the following information will be displayed:

```
*Jan 1 00:09:42: %USB-5-USB_DISK_FOUND: USB Disk <Mass Storage> has been inserted to USB port 0!
*Jan 1 00:09:42: %USB-5-USB_DISK_PARTITION_MOUNT: Mount usb0(type:FAT32),size : 1050673152B(1002MB)
```

i "Mass Storage" indicates the name of the searched device, and "usb0:" indicates the first USB. "Size" indicates the size of the partition. For example, according to the preceding information displayed, the USB flash drive has a space of 1002 MB.

📄 Removing the USB

Use a command line interface (CLI) command to remove the USB first; otherwise, an error may occur if the system is currently using the USB.

- If the USB is successfully removed, the following information will be displayed:

```
OK, now you can pull out the device 0.
```

You can remove the USB only after the preceding information is displayed.

11.4 Configuration

| Configuration | Description and Command |
|----------------|---|
| Using a USB |  Mandatory. |
| | N/A |
| Removing a USB |  (Mandatory) It is used to remove a USB. |
| | usb remove Removes a USB. |

11.4.1 Using a USB

Configuration Effect

After a USB is loaded, you can run the file system commands (such as **dir**, **copy**, and **del**) to perform operations on the USB.

Notes

- The Ruijie General Operating System (RGOS) is applicable only to devices (generally common USB flash drives) that support standard Small Computer System Interface (SCSI) commands. Other devices, such as the USB flash drive embedded in the USB network interface card (NIC) and USB flash drive with the virtual CD-ROM drive, cannot be used in the RGOS. Some devices are configured with the function of converting a USB port to the serial port.

- The USB supports only the FAT file system. Other file systems on the USB must be formatted to the FAT file system on a PC before the USB can be used on a device.
- The RGOS supports the hub. When a USB flash drive is inserted to a port on a hub, the access path becomes different. If the USB flash drive is inserted to a USB port on a device, the access path is **usbX:/**, where **X** indicates the device ID. You can run the **show usb** command to display this path. If the USB flash drive is inserted to a USB port through a hub, the access path is **usbX-Y:/**, where **X** indicates the device ID, and **Y** indicates the hub port ID. For example, **usb0-3:/** indicates port 3 on the hub that is connected to USB port 0 on the device.

Configuration Steps

▾ Identifying a USB

A USB can be directly inserted to the USB slot without a CLI operation.

▾ Using a USB

Perform the following operations to copy files from a USB to the flash:

- Run the **cd** command to enter the partition of the USB.
 - Run the **copy** command to copy files on the USB to the flash on the device.
 - Run the **dir** command to check whether the files are copied to the device.
-
- i** If the USB has multiple partitions, you can access only the first FAT partition on the device.
 - i** The path of the USB does not contain any upper-level directory. After running the **cd usbX:** command to access a USB, you can run the **cd flash:** command to return to the flash file system.
-

Verification

Run the **show usb** command to display information about the USB inserted to the device.

Configuration Example

▾ Using a USB Flash Drive

| | |
|----------------------------|---|
| Scenario | Standalone environment |
| Configuration Steps | <ul style="list-style-type: none"> ● Insert the USB flash drive into the USB slot of the device. ● Run the show usb command on the device console. ● Copy the config.txt file from the USB flash drive to the flash on the device. |
| | <pre>Ruijie#show usb Device: Mass Storage ID: 0 URL prefix: usb0 Disk Partitions:</pre> |

```

usb0(type:vfat)
Size:15789711360B(15789.7MB)
Available size:15789686784B(15789.6MB)
Ruijie#
Ruijie#
Ruijie#dir usb0:/
Directory of usb0:/
  1 -rwx          4 Tue Jan  1 00:00:00 1980  fac_test
  2 -rwx          1 Mon Sep 30 13:15:48 2013  config.txt
2 files, 0 directories
15,789,711,360 bytes total (15,789,686,784 bytes free)
Ruijie#
Ruijie#
Ruijie#copy usb0:/config.txt flash:/
Copying: !
Accessing usb0:/config.txt finished, 1 bytes prepared
Flushing data to flash:/config.txt...
Flush data done
Ruijie#
Ruijie#
    
```

Verification ● Check whether the **config.txt** file exists on the flash.

```

Ruijie#
Ruijie#dir flash:/
Directory of flash:/
  1 drw-          160 Wed Mar 31 08:40:01 2010  at
  2 drwx          160 Thu Jan  1 00:00:11 1970  dm
  3 drwx          160 Thu Jan  1 00:00:05 1970  rep
  4 drwx          160 Mon Apr 26 03:42:00 2010  scc
  5 drwx          160 Wed Mar 31 08:39:52 2010  ssh
  6 drwx          224 Thu Jan  1 00:00:06 1970  var
    
```



```

 7 d---          288 Sat May 29 06:07:45 2010 web
 8 drwx          160 Thu Jan  1 00:00:11 1970 addr
 9 drwx          160 Sat May 29 06:07:44 2010 cwmp
10 drwx          784 Sat May 29 06:07:47 2010 sync
11 --w-          92 Tue Feb  2 01:06:55 2010 config_vsu.dat
12 -rw-         244 Sat Apr  3 04:56:52 2010 config.text
13 -rwx           1 Thu Jan  1 00:00:30 1970 .issu_state
14 -rw-           0 Tue Feb  2 01:07:03 2010 ss_ds_debug.txt
15 -rw-        8448 Thu Jan  1 00:01:41 1970 .shadow
16 -rwx          268 Thu Jan  1 00:01:41 1970 .pswdinfo
17 -rw-           4 Tue May 25 09:12:01 2010 reload
18 drwx          232 Wed Mar 31 08:40:00 2010 snpv4
19 drwx         6104 Sat May 29 06:10:45 2010 .config
20 ----           1 Thu Jan  1 00:04:51 1970 config.txt
21 d---          160 Thu Jan  1 00:00:12 1970 syslog
22 drwx          160 Tue May 25 03:05:01 2010 upgrade_ram
23 drwx          160 Tue Feb  2 01:06:54 2010 dm_vdu
24 -rwx          16 Thu Jan  1 00:01:41 1970 .username.data

9 files, 15 directories

5,095,424 bytes total (4,960,256 bytes free)

Ruijie#

```

Common Errors

- Insert a USB flash drive that supports non-SCSI commands to the device.
- The USB does not use the FAT file system, and cannot be identified by the system.

11.4.2 Removing a USB

Configuration Effect

Remove the USB and ensure that the USB and the device are intact.

Notes

- Run the **usb remove** command before removing the USB; otherwise, a system error occurs.

Configuration Steps

Running the Remove Command

- Mandatory.
- Run the **usb remove** command before removing the USB.

Removing the USB

After the remove command is executed, remove the USB.

Verification

Run the **show usb** command to display information about the USB inserted to the device.

Related Commands

Removing a USB

| | |
|------------------------------|--|
| Command | usb remove <i>device-id</i> |
| Parameter Description | <i>device-id</i> : Indicates the ID of the USB port on the device. You can run the show usb command to display this ID. |
| Command Mode | Privileged EXEC mode |
| Usage Guide | Before removing a USB, run the usb remove command; otherwise, an error occurs if the USB is in use. If the command is executed, related information will be displayed, and you can remove the USB. If the command execution fails, the USB is in use. In this case, do not remove the USB until it is not in use. |

Configuration Example

Removing a USB

| | |
|----------------------------|---|
| Scenario | Standalone environment |
| Configuration Steps | <ul style="list-style-type: none"> ● Run the show usb command to display the ID of the USB. ● Run the usb remove command to remove the USB. |
| | <pre>Ruijie#show usb Device: Mass Storage ID: 0 URL prefix: usb0 Disk Partitions: usb0(type:vfat) Size:15789711360B(15789.7MB)</pre> |

| | |
|---------------------|---|
| | <pre> Available size:15789686784B(15789.6MB) Ruijie# Ruijie# Ruijie#usb remove 0 OK, now you can pull out the device 0. </pre> |
| Verification | <ul style="list-style-type: none"> Run the show usb command again to check whether the USB is removed. If the device with ID 0 is not displayed in output of the show usb command, the USB is removed. |
| | <pre> Ruijie#show usb Ruijie# </pre> |

11.5 Monitoring

Displaying

| Description | Command |
|--|-----------------|
| Displays information about the inserted USB. | show usb |

12 Configuring PKG_MGMT

12.1 Overview

Package management (pkg_mgmt) is a package management and upgrade module. This module is responsible for installing, upgrading/degrading, querying and maintaining various components of the device, among which upgrade is the main function. Through upgrade, users can install new version of software that is more stable or powerful. Adopting a modular structure, the RGOS system not only supports overall upgrade and subsystem upgrade but also supports separate upgrade of a feature package. In addition, the RGOS system supports upgrade through hot patches.

- ✔ Component upgrade described in this document applies to both the box-type device and rack-type device. In addition, this document is for only version 11.0 and later, excluding those upgraded from earlier versions.

Protocols and Standards

N/A

12.2 Applications

| Application | Scenario |
|--|---|
| Upgrading/Degrading Subsystem | Upgrade subsystem firmware like boot, kernel, and rootfs on the box-type device and rack-type device. |
| Upgrading/Degrading a Single Feature Package | Upgrade a single feature package on the box-type device and rack-mount device. |
| Installing a Hot Patch Package | Install a hot patch, and repair a certain part of the feature component. |

1.2.1 Upgrading/Degrading Subsystem

Scenario

After the upgrade of a subsystem firmware is complete, all system software on the device is updated, and the overall software is enhanced. Generally, the subsystem firmware of the box-type device is called main package.

The main features of this upgrade mode are as follows: All software on the device is updated after the upgrade is completed; all known software bugs are fixed. It takes a long time to finish upgrade.

Deployment

You can store the main package in the root directory of the TFTP server, download the package to the device, and then run an upgrade command to upgrade the package locally. You can also store the main package in a USB flash drive, connect the USB flash drive to the device, and then run an upgrade command to upgrade the package.

1.2.2 Upgrading/Degrading a Single Feature Package

Scenario

Device software consists of several components, and each component is an independent feature module. After an independent feature package is upgraded, only the feature bug corresponding to this package is fixed. Besides, this feature is enhanced with the other features unchanged.

The features of this upgrade mode are as follows: Generally, a feature package is small and the upgrade speed is high. After the upgrade is completed, only the corresponding functional module is improved, and other functional modules remain unchanged.

Deployment

You can store this package in the root directory of the TFTP server, download the package to the local device, and then complete the upgrade. You can also store the package in a USB flash drive, connect the USB flash drive to the device, and then complete the upgrade.

1.2.3 Installing a Hot Patch Package

Scenario

To fix software bugs without restarting the device, you can install hot patch packages. Hot patch packages are only applicable to fixing a specific software version. Generally, hot patch packages are released to fix the software of a certain version only when the device cannot be started in the user's environment.

The most significant feature of hot patch upgrade is that all bugs can be fixed without device restart after the upgrade is completed.

Deployment

You can store this package in the root directory of the TFTP server, download the package to the local device, and then complete the upgrade. You can also store the package in a USB flash drive, connect the USB flash drive to the device, and then complete the upgrade.

12.3 Features

Basic Concepts

↳ Subsystem

A subsystem exists on a device in the form of images. The subsystems of the RGOS include:

- boot: After being powered on, the device loads and runs the boot subsystem first. This subsystem is responsible for initializing the device, and loading and running system images.
- kernel: kernel is the OS core part of the system. This subsystem shields hardware composition of the system and provides applications with abstract running environment.

- rootfs: rootfs is the collection of applications in the system.

↳ **Main Package**

- Main package is often used to upgrade/degrade a subsystem of the box-type device. The main package is a combination package of the boot, kernel, and rootfs subsystems. The main package can be used for overall system upgrade/degradation.

↳ **Feature Package of RGOS**

- The feature package of RGOS refers to a collection which enables a certain feature. When the device is delivered, all supported functions are contained in the rootfs subsystem. You can upgrade only a specific feature by upgrading a single feature package.

↳ **Hot Patch Package**

- A hot patch package contains the hot patches of several features. You can upgrade a hot patch package to install patches for various features. New features are provided immediately without device restart after the upgrade.

 "Firmware" in this document refers to an installation file that contains a subsystem or feature module.

Overview

| Feature | Description |
|--|---|
| Upgrading/Degrading and Managing Subsystem Components | Upgrades/degrades a subsystem. |
| Upgrading/Degrading and Managing Functional Components | Upgrades/degrades a functional component. |
| Upgrading/Degrading and Managing Hot Patch Packages | Installs a hot patch package. |

1.3.1 Upgrading/Degrading and Managing Subsystem Components

Subsystem upgrade/degradation aims to upgrade the software by replacing the subsystem components of the device with the subsystem components in the firmware. The subsystem component contains redundancy design. Subsystems of the device are not directly replaced with the subsystems in the package during upgrade/degradation in most cases. Instead, subsystems are added to the device and then activated during upgrade/degradation.

Working Principle

↳ **Upgrade/Degradation**

Various subsystems exist on the device in different forms. Therefore, upgrade/degradation varies with different subsystems.

- boot: Generally, this subsystem exists on the norflash device in the form of images. Therefore, upgrading/degrading this subsystem is to write the image into the norflash device.

- kernel: This subsystem exists in a specific partition in the form of files. Therefore, upgrading/degrading this subsystem is to write the file.
- rootfs: Generally, this subsystem exists on the nandflash device in the form of images. Therefore, upgrading/degrading this subsystem is to write the image into the nandflash device.

Management

Query the subsystem components that are available currently and then load subsystem components as required.

Each subsystem component contains redundancy design. During the upgrade/degradation:

- boot: The boot subsystem always contains a master boot subsystem and a slave boot subsystem. Only the master boot subsystem is involved in the upgrade, and the slave boot subsystem serves as the redundancy backup all along.
- kernel: as the kernel subsystem contains at least one redundancy backup. More redundancy backups are allowed if there is enough space.
- rootfs: The rootfs subsystem always contains a redundancy backup.

The boot component is not included in the scope of subsystem management due to its particularity. During upgrade of the kernel or rootfs subsystem component, the upgrade/degradation module always records the subsystem component in use, the redundant subsystem component, and management information about various versions.

Relevant Configuration

Upgrade

- Store the upgrade file on the local device, and then run the **upgrade** command for upgrade.

1.3.2 Upgrading/Degrading and Managing Functional Components

Working Principle

In fact, upgrading a feature is replacing feature files on the device with the feature files in the package.

Managing feature components and hot patches is aimed at recording the information of feature components and hot patches by using a database. In fact, installing, displaying and uninstalling a component is the result of performing the Add, Query and Delete operation on the database.

After package upgrade, component upgrade cannot be performed.

Relevant Configuration

Upgrade

- Store the upgrade file on the local device, and then run the **upgrade** command for upgrade.

1.3.3 Upgrading/Degrading and Managing Hot Patch Packages

Working Principle

In fact, upgrading a feature component is replacing feature files on the device with the feature files in the package.

Upgrading hot patch packages is similar to upgrading features. The difference is that only files to be revised are replaced during hot patch package upgrade. In addition, after the files are replaced, the new files take effect automatically.

After package upgrade, component upgrade cannot be performed.

▾ **Management**

Similar to feature component management, hot patch management also includes the query, installation, and uninstallation operation, which is the result of adding, querying and deleting data respectively.

Hot patches and feature components are managed based on the same technology. The difference is that the hot patches involve three different states, that is, Not installed, Installed, and Activated. These states are described as follows:

The hot patch in Installed state only indicates that this hot patch exists on the device, but it has not taken effect yet.

Only the hot patch in Activated state is valid.

Relevant Configuration

▾ **Upgrade**

- Store the upgrade file in the local file system, and then run the **upgrade** command for upgrade.

▾ **Activating a Hot Patch**

- You can run the **patch active** command to activate a patch temporarily. The patch becomes invalid after device restart. To use this patch after device restart, you need to activate it again.
- You can also run the **patch running** command to activate a patch already permanently. The patch is still valid after device start.
- The patch not activated will never become valid.

▾ **Deactivating a Hot Patch**

- To deactivate an activated patch, run the **patch deactive** command.

▾ **Uninstalling a Hot Patch**

- You can run the **patch delete** command to uninstall a hot patch.

12.4 Configuration

| Configuration | Description and Command |
|--|---|
| Upgrading/Degrading a Firmware |  The basic function of the configuration is installing and upgrading/degrading a subsystem firmware, feature package, and hot patch package. This command is valid on both the box-type device and rack-type device. |

| | | |
|--|--|---|
| | upgrade <i>url</i> | <i>url</i> is a local path where the firmware is stored. This command is used to upgrade the firmware stored on the device. |
| | upgrade download tftp:/ <i>path</i> | <i>path</i> is the path of the firmware on the server. This command is used to download a firmware from the server and upgrade the package automatically. |

1.4.1 Upgrading/Degrading a Firmware

Configuration Effect

Available firmwares include the main package, rack package, various feature packages and hot patch packages.

- After the upgrade of the main package is complete, all system software on the line card is updated, and the overall software is enhanced.
- After an independent feature package is upgraded, only the feature bug corresponding to this package is fixed. Besides, this feature is enhanced, with other features remain unchanged.
- Upgrading hot patch packages is aimed at fixing software bugs without restarting the device. Hot patch packages are only applicable to fixing bugs for a specific version of software.

✔ Generally a main package is released to upgrade a box-type device.

Notes

N/A

Configuration Steps

⌵ Upgrading the Main Package for a Single Device

- Optional configuration. This configuration is required when all system software on the device needs to be upgraded.
- Download the firmware to the local device and run the **upgrade** command.

✔ Generally a main package is pushed to upgrade a box-type device.

⌵ Upgrading Each Feature Package

- Optional configuration. The configuration is used to fix bugs of a certain feature and enhance the function of this feature.
- Download the firmware to the local device and run the **upgrade** command.

⌵ Upgrading a Hot Patch Package

- Optional configuration. The configuration is used to fix software bugs without restarting the device.
- Download the firmware to the local device and run the **upgrade** command.

- After being upgraded, the hot patch can be used after it is activated. The configuration in this step is mandatory. Two activation modes are available: Run the **patch active** command to activate a patch temporarily, or run the **patch running** command to activate a patch permanently.

 Generally, the **patch running** command must be used to activate a patch permanently in the user scenario. The **patch active** command can be used to activate a patch only when a user intends to verify the patch.

↳ **Subsystem Rollback**

- Optional configuration. This configuration aims to roll a subsystem back to the state before the upgrade, select this configuration item..
- This configuration takes effect after you run the **upgrade** command to upgrade the subsystem component (for example, the main package).

 After you run the **upgrade** command to upgrade a subsystem component in the user scenario, you can run the rollback command once, that is, consecutive rollback is not supported.

Verification

- After upgrading a subsystem component, you can run the **show upgrade history** command to check whether the upgrade is successful.
- After upgrading a feature component, you can run the **show component** command to check whether the upgrade is successful.
- After upgrading a hot patch package, you can run the **show patch** command to check whether the upgrade is successful.

Commands

↳ **Upgrade**

| | |
|------------------------------|--|
| Command | upgrade url [force] |
| Parameter Description | force indicates forced upgrade. |
| Command Mode | Privileged EXEC mode |
| Usage Guide | N/A |

| | |
|------------------------------|--|
| Command | upgrade download tftp:/path [force] |
| Parameter Description | force indicates forced upgrade. |
| Command Mode | Privileged EXEC mode |
| Usage Guide | N/A |

↳ **Displaying the Firmware Stored on the Device**

| | |
|------------------------------|--|
| Command | show upgrade file <i>url</i> |
| Parameter Description | <i>url</i> indicates the path of the firmware in the device file system. |
| Command Mode | Privileged EXEC mode |
| Usage Guide | N/A |

↳ Displaying Upgrade History

| | |
|------------------------------|-----------------------------|
| Command | show upgrade history |
| Parameter Description | N/A |
| Command Mode | Privileged EXEC mode |
| Usage Guide | N/A |

↳ Subsystem Component Rollback

| | |
|------------------------------|--|
| Command | upgrade rollback |
| Parameter Description | N/A |
| Command Mode | Privileged EXEC mode |
| Usage Guide | This command is used to undo the last subsystem upgrade operation and make the subsystem restore to the state before the upgrade. You can perform the rollback operation only if the last upgrade is subsystem upgrade and the upgrade is successful. The rollback command cannot be executed in succession. |

↳ Displaying the Feature Components Already Installed

| | |
|------------------------------|---|
| Command | show component |
| Parameter Description | [<i>component _name</i>]: component name When this parameter value is N/A, the command is used to display all components already installed on the device and basic information of these components. When this parameter value is not N/A, the command is used to display detailed information of the corresponding component, check whether the component is intact, and check whether this component works properly. |
| Command Mode | Privileged EXEC mode |
| Usage Guide | N/A |

↳ Displaying the Patch Packages Already Installed

| | |
|----------------|--|
| Command | show patch [<i>package _name</i>] |
|----------------|--|

| | |
|------------------------------|----------------------|
| Parameter Description | |
| Command Mode | Privileged EXEC mode |
| Usage Guide | N/A |

↘ **Activating the Patches Temporarily**

| | |
|------------------------------|--|
| Command | patch active |
| Parameter Description | N/A |
| Command Mode | Privileged EXEC mode |
| Usage Guide | This operation can be performed only on the device already installed with a patch. This command can be used to activate a patch temporarily, and the activated patch becomes invalid after device restart. |

↘ **Activating the Patches Permanently**

| | |
|------------------------------|--|
| Command | patch running |
| Parameter Description | N/A |
| Command Mode | Privileged EXEC mode |
| Usage Guide | This operation can be performed only on the device already installed with a patch. This command can be used to activate a patch permanently. |

Configuration Example

↘ **Example of Upgrading a Subsystem Firmware on the Box-Type Device**

| | |
|----------------------------|---|
| Network Environment | <p>Before the upgrade, you must copy the firmware to the device. The upgrade module provides the following solutions.</p> <ul style="list-style-type: none"> ● Run some file system commands like copy tftp and copy xmodem to copy the firmware on the server to the device file system, and then run the upgrade url command to upgrade the firmware in the local file system. ● Run the upgrade download tftp://path command directly to upgrade the firmware file stored on the tftp server. ● Copy the firmware to a USB flash drive, insert the USB flash drive to the device, and then run the upgrade url command to upgrade the firmware in the USB flash drive. |
| Configuration Steps | <ul style="list-style-type: none"> ● Run the upgrade command. ● After upgrading the subsystem, restart the device. |
| | <pre>Ruijie# upgrade download tftp://192.168.201.98/eg1000m_main_1.0.0.0f328e91.bin Accessing tftp://192.168.201.98/eg1000m_main_1.0.0.0f328e91.bin...</pre> |

| | |
|---------------------|--|
| | <pre>Ruijie#upgrade sata0://bridge_eg1000m_2.3.1.1252ea-1.mips.rpm Upgrade processing is 10% Upgrade processing is 60% Upgrade processing is 90% Upgrade info [OK] bridge version[2.0.1.37cd5cda ->2.3.1.1252ea] [OK] Upgrade processing is 100% Reload system to take effect! Reload system?(Y/N)y Restarting system.</pre> |
| Verification | <ul style="list-style-type: none"> ● Check the version of the feature component on the current device. If the version information changes, the upgrade is successful. |
| | <pre>Ruijie# show component Package :sysmonit Version:1.0.1.23cd34aa Build time: Wed Dec 7 00:58:56 2011 Size:12877 Install time :Wed Mar 5 14:23:12 2012 Description:this is a system monit package Required packages: None ----- package:bridge Version: 2.3.1.1252ea Build time: Wed Dec 7 00:54:56 2011 Size:26945 Install time : Wed Mar 19:23:15 2012 Description:this is a bridge package Required packages: None</pre> |

📌 Example of Installing a Patch Package on the Box-Type Device

| | |
|----------------------------|--|
| Network Environment | <p>Before the upgrade, you must copy the firmware to the device. The upgrade module provides the following solutions.</p> <ul style="list-style-type: none"> ● Run some file system commands like copy tftp and copy xmodem to copy the firmware on the server to the device file system, and then run the upgrade url command to upgrade the firmware in the local file system. ● Run the upgrade download tftp://path command directly to upgrade the firmware file stored on the tftp server. ● Copy the firmware to a USB flash drive, connect the USB flash drive to the device, and then run the upgrade url command to upgrade the firmware in the USB flash drive. |
| Configuration Steps | <ul style="list-style-type: none"> ● Run the upgrade command. ● Activate the hot patch. |
| | <pre>Ruijie#upgrade download tftp://192.168.201.98/eg1000m_RGOS11.0(1C2)_20131008_patch.bin Accessing tftp://192.168.201.98/eg1000m_RGOS11.0(1C2)_20131008_patch.bin...</pre> |

| | |
|---------------------|--|
| | <pre> rootfs rollback version[1.0.0.1bcc12e8->1.0.0.2ad02537][OK] Rollback success! Reload system to take effect! Reload system?(Y/N)y Restarting system. </pre> |
| Verification | <ul style="list-style-type: none"> ● Check the system version on the current device. If it is restored to the version before the upgrade, the rollback is successful. |
| | <pre> Ruijie#show upgrade history Last Upgrade Information: Time: 2014-08-31 12:15:03 Method: LOCAL Package Name: N18000_RGOS11.0(1)B1_CM_01200616_install.bin Package Type: Distribution </pre> |

Common Errors

If an error occurs during the upgrade, the upgrade module displays an error message. The following provides an example:

```

Upgrade info [ERR]
  Reason:creat config file err(217)
                    
```

The following describes several types of common error messages:

- Invalid firmware: The cause is that the firmware may be damaged or incorrect. It is recommended to obtain the firmware again and perform the upgrade operation.
- Firmware not supported by the device: The cause is that you may use the firmware of other devices by mistake. It is recommended to obtain the firmware again, verify the package, and perform the upgrade operation.
- Insufficient device space: Generally, this error occurs on a rack-type device. It is recommended to check whether the device is supplied with a USB flash drive. Generally, this device has a USB flash drive.

1.4.2 Deactivating and Uninstalling a Hot Patch

Configuration Effect

An activated hot patch is deactivated or uninstalled.

Notes

A hot patch that is not activated does not take effect; therefore, you cannot deactivate it.

Configuration Steps

↘ Deactivating an Activated Patch

- Optional configuration. To deactivate an activated patch, run the **patch deactivate** command.

↘ Uninstalling a Hot Patch

- Optional configuration. To uninstall a hot patch already installed, run the **patch delete** command.

Verification

- You can run the **show patch** command to check whether a patch is activated or uninstalled.

Commands

Deactivating an Activated Patch

| | |
|---------------------|---|
| Command | patch deactive [slot { num M1 M2 all }] |
| Parameter | slot: indicates that this command is executed on the device in the specified slot. |
| Description | <i>num:</i> indicates the slot number of the specified line card. M1 and M2: indicate the supervisor modules. all: indicates all devices. |
| Command Mode | Privileged EXEC mode |
| Usage Guide | You can perform this operation on only an activated patch. |

Deleting a Hot Patch

| | |
|---------------------|---|
| Command | patch delete |
| Parameter | N/A |
| Description | |
| Command Mode | Privileged EXEC mode |
| Usage Guide | This command is used to remove the hot patch package from the device. |

Configuration Example

Deactivating and Uninstalling a Patch on the Box Device

| | |
|----------------------------|---|
| Configuration Steps | <ul style="list-style-type: none"> ● Run the patch deactivation command. ● Run the patch deletion command. |
| | <pre>Ruijie#patch deactive Deactivate the patch package success Ruijie# patch delete Clear the patch patch_bridge success Clear the patch success</pre> |
| Verification | <ul style="list-style-type: none"> ● Display patch status. |
| | <pre>Ruijie#show patch No patch package installed in the system</pre> |

Common Errors

- Run the **patch deactivate** command when the patch is not activated. It is recommended to check the patch status. You can run the **patch deactivate** command only when the patch is in the **status:running** state.

12.5 Monitoring

Clearing

| Function | Command |
|--|---------------------|
| Deletes a hot patch package already installed. | patch delete |

Displaying

| Function | Command |
|--|---|
| Displays all components already installed on the current device and their information. | show component [<i>component_name</i>] |
| Displays the information about the hot patch packages already installed on the device. | show patch [<i>patch_name</i>] |
| Displays available subsystems (kernel and rootfs) and the subsystems to be loaded by the device. | show subsys |
| Displays the upgrade history. | show upgrade history |

13 Configuring NTP

13.1 Overview

The Network Time Protocol (NTP) is an application-layer protocol that enables network devices to synchronize time. NTP enables network devices to synchronize time with their servers or clock sources and provides high-precision time correction (the difference from the standard time is smaller than one millisecond in a LAN and smaller than decades of milliseconds in a WAN). In addition, NTP can prevent attacks by using encrypted acknowledgment.

Currently, Ruijie devices can be used both as NTP clients and NTP servers. In other words, a Ruijie device can synchronize time with a time server, and be used as a time server to provide time synchronization for other devices. When a Ruijie device is used as a server, it supports only the unicast server mode.

Protocols and Standards

- RFC 1305 : Network Time Protocol (Version 3)

13.2 Applications

| Application | Description |
|--|--|
| Synchronizing Time Based on an External Reference Clock Source | A device is used as a client that synchronizes time with an external clock source. After successful synchronization, it is used as a server to provide time synchronization for other devices. |
| Synchronizing Time Based on a Local Reference Clock Source | A device uses a local clock as a reliable NTP reference clock source and is also used as a server to provide time synchronization for other devices. |

13.2.1 Synchronizing Time Based on an External Reference Clock Source

Scenario

As shown in Figure 13-1:

- DEVICE-A is used as a reliable reference clock source to provide time synchronization for external devices.
- DEVICE-B specifies DEVICE-A as the NTP server and synchronizes time with DEVICE-A.
- After successful synchronization, DEVICE-B provides time synchronization for DEVICE-C.

Figure 13-1

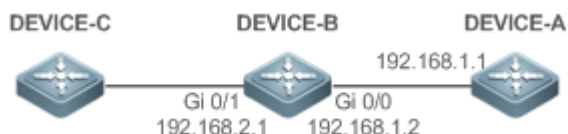

Deployment

Configure DEVICE-B to the NTP external reference clock mode.

13.2.2 Synchronizing Time Based on a Local Reference Clock Source

Scenario

As shown in Figure 13-2, DEVICE-B uses a local clock as the NTP reference clock source and provides time synchronization for DEVICE-C.

Figure 13-2

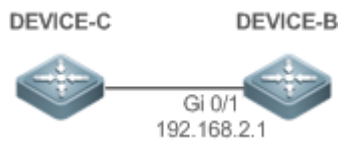

Deployment

Configure DEVICE-B to the NTP local reference clock mode.

13.3 Features

Basic Concepts

↳ NTP Packet

As defined in RFC1305, NTP uses User Datagram Protocol (UDP) packets for transmission and the used UDP port ID is 123.

Figure 13-3 shows the format of an NTP time synchronization packet.

Figure 13-3 Format of an NTP Time Synchronization Packet

| | | | | | | | | |
|-------------------------------------|----|------|---------|---------------|-----------|----|--|----|
| 0 | | 7 | | 15 | | 23 | | 31 |
| LI | VN | Mode | Stratum | Poll Interval | Precision | | | |
| Root Delay (32-bit) | | | | | | | | |
| Root Dispersion (32-bit) | | | | | | | | |
| Reference Clock Identifier (32-bit) | | | | | | | | |
| Reference Timestamp (64-bit) | | | | | | | | |
| Originate Timestamp (64-bit) | | | | | | | | |
| Receive Timestamp (64-bit) | | | | | | | | |
| Transmit Timestamp (64-bit) | | | | | | | | |
| Authenticator (optional 96-bit) | | | | | | | | |

- Leap Indicator(LI): indicates a 2-bit leap second indicator.
-
- **i** 00: indicates no warning information; 01: indicates that there are 61 seconds in the previous minute; 10: indicates that there are 59 seconds in the previous minute; 11: indicates that the clock is not synchronized.
-
- Version Number(VN): indicates a 3-bit NTP version number. The current version number is 3.
 - Mode: indicates a 3-bit NTP working mode.
-
- **i** 0: indicates no definition; 1: indicates symmetric active; 2: indicates symmetric passive; 3: indicates a client; 4: indicates a server; 5: indicates broadcasting; 6: indicates control information; 7: reserved.
-
- Stratum: indicates the 8-bit stratum of a local clock. 0: indicates no definition; 1: indicates the master reference clock source; other values: indicate slave reference clock sources.
 - Poll Interval: indicates the poll interval (seconds), which is a 8-bit integer.
 - Precision: indicates the time precision (seconds) of a local clock, which is a 8-bit integer.
 - Root Delay: indicates the round-trip time to the master reference clock source, which is a 32-bit integer.
 - Root Dispersion: indicates the largest difference from the master reference clock source, which is a 32-bit integer.
 - Reference Clock Identifier: indicates the 32-bit identifier of a reference clock source.
 - Reference Timestamp: indicates a 64-bit timestamp, namely, the time that is set or corrected at the last time.
 - Originate Timestamp: indicates a 64-bit timestamp, namely, the local time when a time synchronization request leaves from a client.
 - Receive Timestamp: indicates a 64-bit timestamp, namely, the local time when a time synchronization request packet arrives at a server.
 - Transmit Timestamp: indicates a 64-bit timestamp, namely, the local time when a time synchronization response packet leaves from a server.
 - Authenticator (optional): indicates authentication information.

↘ NTP Server

A device uses a local clock as the reference clock source to provide time synchronization for other devices in the network.

↘ NTP Client

A device is used as an NTP client that synchronizes time with an NTP server in the network.

↘ Stratum

In NTP, "stratum" is used to describe the hops from a device to an authority clock source. An NTP server whose stratum is 1 has a directly connected atomic clock or radio controlled clock; an NTP server whose stratum is 2 obtains time from the server whose stratum is 1; an NTP server whose stratum is 3 obtains time from the server whose stratum is 2; and so on. Therefore, clock sources with lower stratum values have higher clock precisions.

↘ Hardware Clock

A hardware clock operates based on the frequency of the quartz crystal resonator on a device and is powered by the device battery. After the device is shut down, the hardware clock continues running. After the device is started, the device obtains time information from the hardware clock as the software time of the device.

Overview

| Feature | Description |
|---|--|
| NTP Time Synchronization | Network devices synchronize time with their servers or reliable clock sources to implement high-precision time correction. |
| NTP Security Authentication | The NTP packet encryption authentication is used to prevent unreliable clock sources from time synchronization interference on a device. |
| NTP Access Control | An Access Control List (ACL) is used to filter sources of received NTP packets. |

13.3.1 NTP Time Synchronization

Working Principle

NTP time synchronization is implemented by interaction of NTP packets between a client and a server:

- The client sends a time synchronization packet to all servers every 64 seconds. After receiving response packets from the servers, the client filters and selects the response packets from all servers, and synchronizes time with an optimum server.
- After receiving the time synchronization request packet, a server uses the local clock as the reference source, and fills the local time information into the response packet to be sent to the client based on the protocol requirement.

Figure 13-4 shows the format of an NTP time synchronization packet.

Figure 13-4 Working Principle of NTP

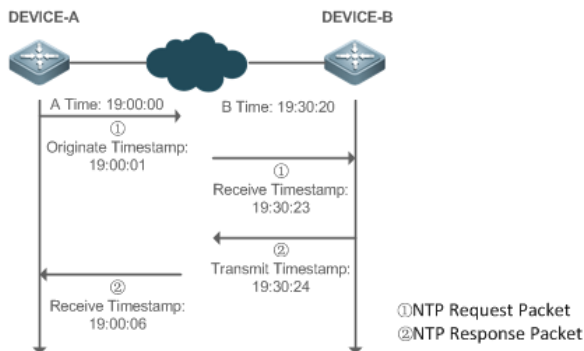

DEVICE-B (B for short) is used as an NTP reference clock source, DEVICE-A (A for short) is used as an NTP client that synchronizes time with DEVICE-B. At a time point, the local clock of A is 19:00:00 and the local clock of B is 19:30:20.

1. A sends an NTP request packet. The local time (T_0) when the packet leaves from A is 19:00:00 and is filled in Originate Timestamp.
2. After a 2-second network delay, the local time (T_1) when B receives the request packet is 19:30:23 and is filled in Receive Timestamp.
3. B processes the NTP request and sends an NTP response packet one second later. The local time (T_2) when the response packet leaves from B is 19:30:24 and is filled in Transmit Timestamp.
4. After a 2-second network delay, A receives the response packet. The local time (T_3) when the response packet arrives at A is 19:00:06.

The specific calculations for time synchronization are as follows:

- A obtains the time difference of 30 minutes and 20 seconds between B and A by using the formula $((T_1 - T_0) + (T_2 - T_3)) / 2$.
- A obtains the packet round-trip delay of four seconds between A and B by using the formula $(T_3 - T_0) - (T_2 - T_1)$.

▾ NTP Working Mode

- External clock reference mode

In this mode, a device is used as both a server and a client. If receiving time synchronization requests from other clients, the device must synchronize time with the specified server first and provide time synchronization for the clients after successful synchronization.

- Local clock reference mode

In this mode, a device uses the default local clock as the reliable clock source and provides time synchronization directly for other clients.

Related Configuration

▾ Configuring an NTP Server

- The NTP function is disabled by default.
- Run the **ntp server** command to specify an NTP server (external clock reference source), which can enable NTP.

- After the configuration, the device works in the external clock reference mode.

↘ Real-time Synchronization

- A device performs time synchronization every 64 seconds by default.

↘ Updating a Hardware Clock

- By default, a device does not update synchronized time to the hardware clock.
- Run the **ntp update-calendar** command to enable a device to automatically update the hardware clock after successfully synchronizing time each time.

↘ Configuring the NTP Master Clock

- By default, a device works in the external clock reference mode.
- Run the **ntp master** command to configure a device to the local clock reference mode.

13.3.2 NTP Security Authentication

To prevent malicious damage on an NTP server, NTP uses the authentication mechanism to check whether the time synchronization information is really from the announced server and check the information return path to provide an anti-interference protection mechanism.

Working Principle

An NTP client and an NTP server are configured with the same key. When sending request and response packets, a device calculates the hash values of the packets by using the MD5 algorithm based on the specified key and NTP packet content, and fills the hash values into the packet authentication information. The receiving device checks whether the packets are sent by a trusted device or modified based on the authentication information.

Related Configuration

↘ Configuring a Global Security Authentication Mechanism for NTP

- By default, no NTP security authentication mechanism is enabled.
- Run the **ntp authenticate** command to enable the NTP security authentication mechanism.

↘ Configuring a Global Authentication Key for NTP

- By default, no global authentication key is configured.
- Run the **ntp authentication-key** command to enable an NTP global authentication key.

↘ Configuring a Globally Trusted Key ID for NTP

- By default, no globally trusted key is configured.
- Run the **ntp trusted-key** command to configure a device as the reference clock source to provide a trusted key for time synchronization externally.

▾ **Configuring a Trusted Key ID for an External Reference Clock Source**

- Run the **ntp server** command to specify an external reference source and the trusted key of this clock source as well.

13.3.3 NTP Access Control

Working Principle





Provide a minimum security measure by using an ACL.

Related Configuration

▾ **Configuring the Access Control Rights for NTP Services**

- By default, there is no access control right for NTP.
- Run the **ntp access-group** command to configure the access control rights for NTP.

13.4 Configuration

| Configuration | Description and Command |
|---|--|
| Configuring Basic Functions of NTP |  (Mandatory) It is used to enable NTP. After NTP is enabled, a device works in the external clock reference mode. |
| | ntp server Configures an NTP server. |
| | ntp update-calendar Automatically updates a hardware clock. |
| |  (Optional) It is used to configure a device to the local clock reference mode. |
| | ntp master Configures the NTP master clock. |
| |  (Optional) It is used to disable NTP. |
| | no ntp Disables all functions of NTP and clears all NTP configurations. |
| Configuring NTP Security Authentication | ntp disable Disables receiving of NTP packets from a specified interface. |
| |  (Optional) It is used to prevent unreliable clock sources from performing time synchronization interference on a device. |
| | ntp authenticate Enables a security authentication mechanism. |
| | ntp authentication-key Configures a global authentication key. |
| | ntp trusted-key Configures a trusted key for time synchronization. |

| | | |
|--|--|--|
| | ntp server | Configures a trusted key for an external reference clock source. |
| Configuring NTP Access Control |  (Optional) It is used to filter the sources of received NTP packets. | |
| | ntp access-group | Configures the access control rights for NTP. |

13.4.1 Configuring Basic Functions of NTP

Configuration Effect

External Clock Reference Mode

- Use a device as a client to synchronize time from an external reference clock source to the local clock.
- After the time synchronization is successful, use the device as a time synchronization server to provide time synchronization.

Local Clock Reference Mode

- Use the local clock of a device as the NTP reference clock source to provide time synchronization.

Notes

- In the client/server mode, a device can be used as a time synchronization server to provide time synchronization only after successfully synchronizing time with a reliable external clock source.
- Once the local clock reference mode is configured, the system will not synchronize time with a clock source with a higher stratum.
- Configuring a local clock as the master clock (especially when specifying a lower stratum) may overwrite an effective clock source. If this command is used for multiple devices in a network, the clock difference between the devices may cause unstable time synchronization of the network.
- Before a local clock is configured as the master clock, if the system never synchronizes time with an external clock source, you may need to manually calibrate the system clock to ensure that there is no excessive difference. For details about how to manually calibrate the system clock, refer to the system time configuration section in the configuration guide.

Configuration Steps

Configuring an NTP Server

- (Mandatory) At least one external reference clock source must be specified (A maximum of 20 different external reference clock sources can be configured).
- If it is necessary to configure an NTP key, you must configure NTP security authentication before configuring the NTP server.

Automatically Updating a Hardware Clock

- Optional.
- By default, the system updates only the system clock, but not the hardware clock after successful time synchronization.
- After this command is configured, the system automatically updates the hardware clock after successful time synchronization.

↘ Configuring the NTP Master Clock

- To switch a device to the local clock reference mode, run this command.

↘ Disabling NTP

- To disable NTP and clear NTP configurations, run the **no ntp** command.
- By default, all interfaces can receive NTP packets after NTP is enabled. To disable NTP for a specified interface, run the **ntp disable** command.

Verification

- Run the **show ntp status** command to display the NTP configuration.
- Run the **show clock** command to check whether time synchronization is completed.

Related Commands

↘ Configuring an NTP Server

| | |
|------------------------------|--|
| Command | ntp server { <i>ip-addr</i> <i>domain</i> ip <i>domain</i> ipv6 <i>domain</i> }[version <i>version</i>][source <i>if-name</i>][key <i>keyid</i>][prefer] |
| Parameter Description | <p><i>ip-addr</i>: Indicates the IPv4/IPv6 address of the reference clock source.</p> <p><i>domain</i>: Indicates the IPv4/IPv6 domain name of the reference clock source.</p> <p><i>version</i>: Indicates the NTP version number, ranging from 1 to 3.</p> <p><i>if-name</i>: Indicates the interface type, including AggregatePort, Dialer GigabitEthernet, Loopback, Multilink, Null, Tunnel, Virtual-ppp, Virtual-template and Vlan.</p> <p><i>keyid</i>: Indicates the key used for communicating with the reference clock source, ranging from 1 to 4294967295.</p> <p>prefer: Indicates whether the reference clock source has a high priority.</p> <p><i>mgmt-name</i>: Specifies the egress management interface for packets in the oob mode.</p> |
| Command Mode | Global configuration mode |
| Usage Guide | <p>By default, no NTP server is configured. Ruijie client system supports interaction with up to 20 NTP servers. You can configure an authentication key for each server (after configuring global authentication and the related key) to initiate encrypted communication with the servers.</p> <hr/> <p> If it is necessary to configure an authentication key, you must configure NTP security authentication before configuring an NTP server.</p> |

| | |
|--|--|
| | The default version of NTP for communicating with a server is NTP version 3. In addition, you can configure the source interface for transmitting NTP packets and specify that the NTP packets from a corresponding server can be received only on the transmitting interface. |
|--|--|

↘ Updating a Hardware Clock

| | |
|------------------------------|----------------------------|
| Command | ntp update-calendar |
| Parameter Description | N/A |
| Command Mode | Global configuration mode |
| Usage Guide | N/A |

↘ Configuring a Local Reference Clock Source

| | |
|------------------------------|--|
| Command | ntp master [<i>stratum</i>] |
| Parameter Description | <i>stratum</i> : specifies the stratum of a local clock, ranging from 1 to 15. The default value is 8. |
| Command Mode | Global configuration mode |
| Usage Guide | N/A |

↘ Disabling NTP

| | |
|------------------------------|---|
| Command | no ntp |
| Parameter Description | N/A |
| Command Mode | Global configuration mode |
| Usage Guide | This command can be used to fast disable all functions of NTP and clear all NTP configurations. |

↘ Disabling Receiving of NTP Packets on an Interface

| | |
|------------------------------|------------------------------|
| Command | ntp disable |
| Parameter Description | N/A |
| Command Mode | Interface configuration mode |
| Usage Guide | N/A |

Configuration Example

↘ External Clock Reference Mode of NTP

| | |
|--|--|
| <p>Scenario Figure 13-5</p> | |
| | <ul style="list-style-type: none"> ● DEVICE-B is configured to the NTP external clock reference mode. ● DEVICE-A is used as the reference clock source of DEVICE-B. ● DEVICE-C synchronizes time with DEVICE-B. |
| <p>Configuration Steps</p> | <ul style="list-style-type: none"> ● DEVICE-A configures the local clock as the NTP reference clock source. ● DEVICE-B configures DEVICE-A as the reference clock source. ● DEVICE-C configures DEVICE-B as the reference clock source. |
| <p>DEVICE-A</p> | <pre>A#configure terminal A(config)# ntp master A(config)#exit</pre> |
| <p>DEVICE-B</p> | <pre>B#configure terminal B(config)# ntp server 192.168.1.1 B(config)# exit</pre> |
| <p>DEVICE-C</p> | <pre>C#configure terminal C(config)# ntp server 192.168.2.1 C(config)# exit</pre> |
| <p>Verification</p> | <ul style="list-style-type: none"> ● Run the show ntp status command on DEVICE-B to display the NTP configuration. ● DEVICE-B sends a time synchronization packet to 192.168.1.1 in order to synchronize time with DEVICE-A. ● After successfully synchronizing time with DEVICE-A, DEVICE-B can respond to the time synchronization request from DEVICE-C. ● Run the show clock command on DEVICE-B and DEVICE-C to check whether the time synchronization is successful. |

Local Clock Reference Mode of NTP

| | |
|--|---|
| <p>Scenario Figure 13-6</p> | |
| | <ul style="list-style-type: none"> ● DEVICE-B configures the local clock as the NTP reference clock source. ● DEVICE-C synchronizes time with DEVICE-B. |

| | |
|----------------------------|---|
| Configuration Steps | <ul style="list-style-type: none"> ● DEVICE-B configures the local clock as the NTP reference clock source. ● DEVICE-C configures DEVICE-B as the reference clock source. |
| DEVICE-B | <pre>B#configure terminal B(config)# ntp master B(config)# exit</pre> |
| DEVICE-C | <pre>C#configure terminal C(config)# ntp server 192.168.2.1 C(config)# exit</pre> |
| Verification | <ul style="list-style-type: none"> ● Run the show clock command on DEVICE-C to check whether the time synchronization is successful. |

13.4.2 Configuring NTP Security Authentication

Configuration Effect

↘ Synchronizing Time from a Trusted Reference Clock Source

Use a device as a client to synchronize time only from a trusted external reference clock source to the local clock.

↘ Providing Time Synchronization for a Trusted Device

Use the local clock of a device as the NTP reference clock source to provide time synchronization for only a trusted device.

Notes

The authentication keys of the client and server must be the same.

Configuration Steps

↘ Configuring a Global Security Authentication Mechanism for NTP

- Mandatory.
- By default, a device disables the security authentication mechanism.

↘ Configuring a Global Authentication Key for NTP

- Mandatory.
- By default, a device is not configured with an authentication key.

↘ Configuring a Globally Trusted Key ID for NTP

- Optional.
- To provide time synchronization for a trusted device, you must specify a trusted authentication key by using the key ID.

- Only one trusted key can be configured. The specified authentication key must be consistent with that of the trusted device.

▾ Configuring an Authentication Key ID for an External Reference Clock Source

- Optional.
- To synchronize time with a trusted reference clock source, you must specify a trusted authentication key by using the key ID.
- Each trusted reference clock source is mapped to an authentication key. The authentication keys must be consistent with the keys of trusted reference clock sources.

Verification

- Run the **show run** command to verify the NTP configuration.
- Run the **show clock** command to check whether time is synchronized only with a trusted device.

Related Commands

▾ Enabling a Security Authentication Mechanism

| | |
|------------------------------|---|
| Command | ntp authenticate |
| Parameter Description | N/A |
| Command Mode | Global configuration mode |
| Usage Guide | By default, a client does not use a global security authentication mechanism. If no security authentication mechanism is used, communication will not be encrypted. A global security indicator is not enough to imply that the communication between the client and server is implemented in an encrypted manner. Other global keys and an encryption key for the server must also be configured for initiating encrypted communication between the client and server. |

▾ Configuring a Global Authentication Key

| | |
|------------------------------|--|
| Command | ntp authentication-key <i>key-id</i> md5 <i>key-string</i> [<i>enc-type</i>] |
| Parameter Description | <i>key-id</i> : indicates the ID of a global authentication key, ranging from 1 to 4294967295. <i>key-string</i> : indicates a key string. <i>enc-type</i> : (optional) indicates whether an entered key is encrypted. 0 indicates no encryption, and 7 indicates simple encryption. The default setting is no encryption. |
| Command Mode | Global configuration mode |
| Usage Guide | N/A |

▾ Configuring a Trusted Key for NTP

| | |
|----------------|--------------------------------------|
| Command | ntp trusted-key <i>key-id</i> |
|----------------|--------------------------------------|

| | |
|------------------------------|--|
| Parameter Description | <i>key-id</i> : Indicates the ID of a trusted key, ranging from 1 to 4294967295. |
| Command Mode | Global configuration mode |
| Usage Guide | N/A |

➤ **Configuring a Trusted Key for an External Reference Clock Source**

Refer to the section "[Related Commands](#)"

Configuration Example

➤ **Security Authentication**

| | |
|--------------------------------|--|
| Scenario Figure 13-7 | |
| | <ul style="list-style-type: none"> ● DEVICE-B is configured to the NTP client/server mode and provides NTP services requiring security authentication for DEVICE-C. The authentication key is "abcd". ● DEVICE-A is used as the reference clock source of DEVICE-B. ● DEVICE-C synchronizes time with DEVICE-B. |
| Configuration Steps | <ul style="list-style-type: none"> ● DEVICE-B configures DEVICE-A as the reference clock source. ● DEVICE-C configures DEVICE-B as the reference clock source. |
| DEVICE-B | <pre>B#configure terminal B(config)# ntp authentication-key 1 md5 abcd B(config)# ntp trusted-key 1 B(config)# ntp server 192.168.1.1 B(config)# exit</pre> |
| DEVICE-C | <pre>C#configure terminal C(config)# ntp authentication-key 1 md5 abcd C(config)# ntp server 192.168.2.1 key 1 C(config)# exit</pre> |
| Verification | <ul style="list-style-type: none"> ● DEVICE-B sends a time synchronization packet that carries authentication information to 192.168.1.1 in order to synchronize time with DEVICE-A. ● Run the show clock command on DEVICE-B to check whether the time synchronization is successful. |

13.4.3 Configuring NTP Access Control

Configuration Effect

Access control for NTP services provides a minimum security measure. A more secure method is to use an NTP authentication mechanism.

Notes

- Currently, the system does not support control query (used to control NTP servers by using network management devices, such as setting the leap second indicator or monitoring its working status). Though rule matching is implemented in the preceding sequence, no request related to control query is supported.
- If no access control rule is configured, all accesses are allowed. If any access control rule is configured, only accesses allowed by the rule can be implemented.

Related Configuration

▾ Configuring the Access Control Rights for NTP

- Optional.
- Run the **ntp access-group** command to configure the access control rights and a corresponding ACL for NTP.

Verification

Run the **show run** command to verify the NTP configuration.

Related Commands

▾ Configuring the Access Control Rights for NTP Services

| | |
|------------------------------|--|
| Command | ntp access-group { peer serve serve-only query-only } <i>access-list-number</i> <i>access-list-name</i> |
| Parameter Description | <p>peer: allows time request and control query for local NTP services, and allows a local device to synchronize time with a remote system (full access rights).</p> <p>serve: allows time request and control query for local NTP services, but does not allow a local device to synchronize time with a remote system.</p> <p>serve-only: allows only time request for local NTP services.</p> <p>query-only: allows only control query for local NTP services.</p> <p><i>access-list-number</i>: indicates the number of an IP ACL, ranging from 1 to 99 and from 1300 to 1999. For details about how to create an IP ACL, refer to the <i>Configuring ACL</i>.</p> <p><i>access-list-name</i>: indicates the name of an IP ACL. For details about how to create an IP ACL, refer to the <i>Configuring ACL</i>.</p> |
| Command Mode | Global configuration mode |
| Usage Guide | Configure NTP access control rights. |

| | |
|--|--|
| | When an access request arrives, the NTP service matches rules in the sequence from the minimum access restriction to the maximum access restriction and uses the first matched rule. The matching sequence is peer, serve, serve-only, and query-only. |
|--|--|

Configuration Example

Configuring NTP Access Control Rights

| | |
|----------------------------|--|
| Configuration Steps | Allow only the device with the IP address of 192.168.1.1 to send a time synchronization request to a local device. |
| | <pre>Ruijie(config)# access-list 1 permit 192.168.1.1 Ruijie(config)# ntp access-group serve-only 1</pre> |

13.5 Monitoring

Displaying

| Description | Command |
|------------------------|---------------------------------------|
| show ntp status | Displays the current NTP information. |

Debugging

 System resources are occupied when debugging information is output. Therefore, disable debugging immediately after use.

| Description | Command |
|---------------------|---------------------|
| debug ntp | Enables debugging. |
| no debug ntp | Disables debugging. |

14 Configuring SNTP

14.1 Overview

The Simple Network Time Protocol (SNTP) is a simplified version of Network Time Protocol (NTP), which is used to synchronize the clocks of computers on the Internet. SNTP is applied in scenarios where it is unnecessary to use all NTP functions.

NTP uses a complex algorithm and has higher requirements for the system whereas SNTP uses a simpler algorithm and provides higher performance. Generally, SNTP precision can reach about 1s, which meets the basic requirements of most scenarios. Since SNTP packets are the same as NTP packets, the SNTP client implemented on a device is fully compatible with an NTP server.

Protocols and Standards

- RFC 2030: Simple Network Time Protocol (SNTP) Version 4 for IPv4, IPv6 and OSI

14.2 Applications

| Application | Description |
|---|--|
| Synchronizing Time with an NTP Server | A device is used as a client to synchronize time with an NTP server. |

14.2.1 Synchronizing Time with an NTP Server

Scenario

As shown in Figure 14-1, DEVICE-B uses a local clock as the NTP clock reference source and provides time synchronization for DEVICE-C.

DEVICE-C is used as an SNTP client to synchronize time with DEVICE-B.

Figure 14-1

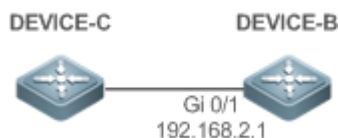

Deployment

- Specify DEVICE-B as the SNTP server of DEVICE-C.
- Enable SNTP for DEVICE-C.

- Root Delay: indicates the round-trip time to the master clock reference source, which is a 32-bit integer.
- Root Dispersion: indicates the largest difference from the master reference clock source, which is a 32-bit integer.
- Reference Clock Identifier: indicates the 32-bit identifier of a reference clock source.
- Reference Timestamp: indicates a 64-bit timestamp, namely, the time that is set or corrected at the last time.
- Originate Timestamp: indicates a 64-bit timestamp, namely, the local time when a time synchronization request leaves from a client.
- Receive Timestamp: indicates a 64-bit timestamp, namely, the local time when a time synchronization request packet arrives at a server.
- Transmit Timestamp: indicates a 64-bit timestamp, namely, the local time when a time synchronization response packet leaves from a server.
- Authenticator (optional): indicates authentication information.

Overview

| Feature | Description |
|---|--|
| SNTP Time Synchronization | Synchronizes time from an SNTP/NTP server to a local device. |

14.3.1 SNTP Time Synchronization

Working Principle

SNTP time synchronization is implemented by interaction of SNTP/NTP packets between a client and a server. The client sends a time synchronization packet to the server at intervals (half an hour by default). After receiving a response packet from the server, the client synchronizes time.

Figure 14-3 shows the format of an SNTP time synchronization packet.

Figure 14-3 Working Principle of SNTP

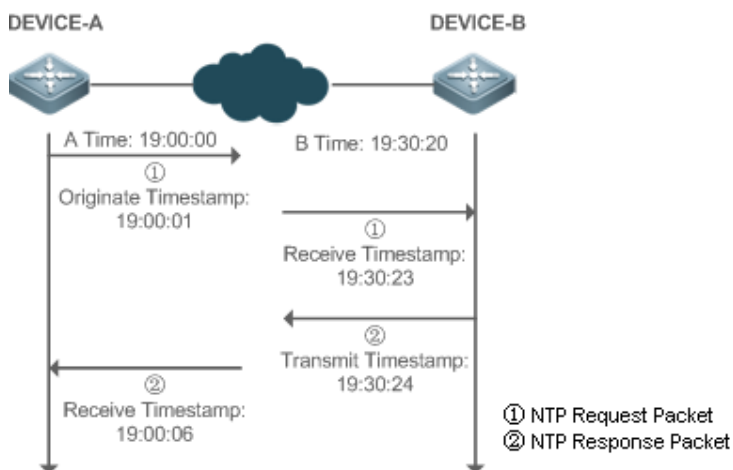

DEVICE-B (B for short) is used as an NTP reference clock source, DEVICE-A (A for short) is used as an SNTP client that synchronizes time with DEVICE-B. At a time point, the local clock of A is 19:00:00 and the local clock of B is 19:30:20.

1. A sends an SNTP/NTP request packet. The local time (T0) when the packet leaves from A is 19:00:00 and is filled in Originate Timestamp.
2. After a 2-second network delay, the local time (T1) when B receives the request packet is 19:30:23 and is filled in Receive Timestamp.
3. B processes the NTP request and sends an NTP response packet one second later. The local time (T2) when the response packet leaves from B is 19:30:24 and is filled in Transmit Timestamp.
4. After a 2-second network delay, A receives the response packet. The local time (T3) when the response packet arrives at A is 19:00:06.

The specific calculations for time synchronization are as follows:

- A obtains the time difference of 30 minutes and 20 seconds between B and A by using the formula $((T1-T0)+(T2-T3))/2$.
- A obtains the packet round-trip delay of four seconds between A and B by using the formula $(T3-T0)-(T2-T1)$.

Related Configuration

▾ Enabling SNTP

- SNTP is disabled by default.
- Run the **sntp enable** command to enable SNTP.



▾ Configuring an SNTP Server

- By default, no SNTP server is configured.
- Run the **sntp server** command to specify an SNTP server.

▾ Configuring the SNTP Time Synchronization Interval

- By default, the SNTP time synchronization interval is 1,800s.
- Run the **sntp interval** command to specify the time synchronization interval.

14.4 Configuration

| Configuration | Description and Command | |
|----------------------------------|--|--|
| Configuring SNTP |  (Mandatory) It is used to enable SNTP. | |
| | sntp enable | Enables SNTP. |
| | sntp server | Configures the IP address of an SNTP server. |
| |  (Optional) It is used to configure the SNTP time synchronization interval. | |

| Configuration | Description and Command | |
|---------------|-------------------------|--|
| | sntp interval | Configures the SNTP time synchronization interval. |

14.4.1 Configuring SNTP

Configuration Effect

An SNTP client accesses an NTP server at fixed intervals to correct the clock regularly.

Notes

All time obtained through SNTP communication is Greenwich Mean Time (GMT). To obtain precise local time, you need to set the local time zone for alignment with GMT.

Configuration Steps

▾ Enabling SNTP

- (Mandatory) SNTP is disabled by default.

▾ Configuring the IP address of an SNTP Server

- (Mandatory) No SNTP/NTP server is configured by default.

▾ Configuring the SNTP Time Synchronization Interval

- Optional.
- By default, a device synchronizes time every half an hour.

Verification

Run the **show sntp** command to display SNTP-related parameters.

Related Commands

▾ Enabling SNTP

| | |
|------------------------------|---|
| Command | sntp enable |
| Parameter Description | N/A |
| Command Mode | Global configuration mode |
| Usage Guide | SNTP is disabled by default. Run the no sntp enable global configuration command to disable SNTP. |

▾ Configuring the IP address of an SNTP/NTP Server

| | |
|----------------|--------------------------------|
| Command | sntp server ip- address |
|----------------|--------------------------------|

| | |
|------------------------------|---|
| Parameter Description | <i>ip-address</i> : indicates the IP address of an SNTP/NTP server. No SNTP/NTP server is configured by default. |
| Command Mode | Global configuration mode |
| Usage Guide | <p>Since SNTP is fully compatible with NTP, the server can be configured as a public NTP server on the Internet.</p> <p>Since SNTP packets are the same as NTP packets, the SNTP client is fully compatible with the NTP server. There are many NTP servers on the Internet. You can select an NTP server with a shorter delay as the SNTP server on your device.</p> |

↘ **Configuring the SNTP Time Synchronization Interval**

| | |
|------------------------------|---|
| Command | sntp interval <i>seconds</i> |
| Parameter Description | <i>seconds</i> : Indicates the time synchronization interval, ranging from 60s to 65,535s. The default value is 1,800s. |
| Command Mode | Global configuration mode |
| Usage Guide | <p>Run this command to set the interval for an SNTP client to synchronize time with an NTP/SNTP server.</p> <p> The interval configured here does not take effect immediately. To make it take effect immediately, run the sntp enable command.</p> |

Configuration Example

↘ **SNTP Time Synchronization**

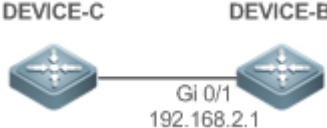
| | |
|--------------------------------|--|
| Scenario Figure 14-4 |  |
| | <ul style="list-style-type: none"> ● DEVICE-B indicates an NTP server on the Internet. ● DEVICE-C synchronizes time with DEVICE-B. |
| Configuration Steps | Enable SNTP for DEVICE-C and configure DEVICE-B as an NTP server. |
| DEVICE-C | <pre>C#configure terminal C(config)# sntp server 192.168.2.1 C(config)# sntp enable C(config)# exit</pre> |
| Verification | <ul style="list-style-type: none"> ● Run the show clock command on DEVICE-C to check whether the time synchronization is successful. |

- Run the **show sntp** command on DEVICE-C to display the SNTP status and check whether the server is successfully configured.

14.5 Monitoring

Displaying

| Description | Command |
|------------------|-----------------------------------|
| show sntp | Displays SNTP-related parameters. |

Debugging

 System resources are occupied when debugging information is output. Therefore, disable debugging immediately after use.

| Description | Command |
|-------------------|--------------------|
| debug sntp | Enables debugging. |

15 Configuring Time Range

15.1 Overview

Time Range is a time-based control service that provides some applications with time control. For example, you can configure a time range and associate it with an access control list (ACL) so that the ACL takes effect within certain time periods of a week.

15.2 Typical Application

| Typical Application | Scenario |
|-------------------------------|---|
| Applying Time Range to an ACL | Apply a time range to an ACL module so that the time-based ACL takes effect |

15.2.1 Applying Time Range to an ACL

Application Scenario

An organization allows users to access the Telnet service on a remote Unix host during working hours only, as shown in Figure 15-1.

Figure 15-1

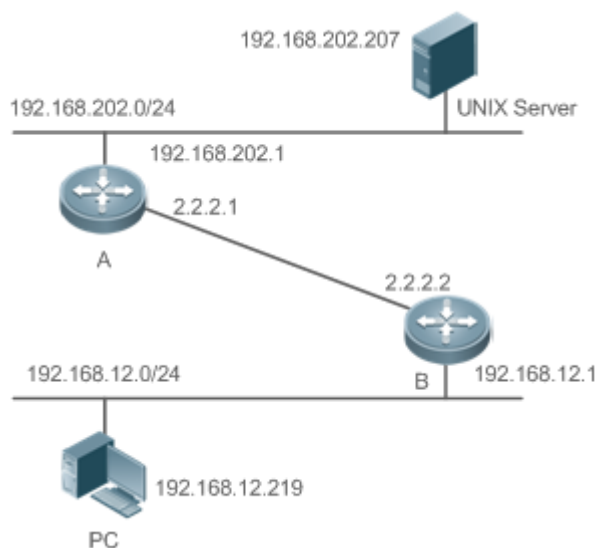

| | |
|------|--|
| Note | Configure an ACL on device B to implement the following security function: |
|------|--|

| | |
|--|--|
| | Hosts in network segment 192.168.12.0/24 can access the Telnet service on a remote Unix host during normal working hours only. |
|--|--|

Functional Deployment

- On device B, apply an ACL to control Telnet service access of users in network segment 192.168.12.0/24. Associate the ACL with a time range, so that the users' access to the Unix host is allowed only during working hours.

15.3 Function Details

Basic Concepts

↳ Absolute Time Range

The absolute time range is a time period between a start time and an end time. For example, [12:00 January 1 2000, 12:00 January 1 2001] is a typical absolute time range. When an application based on a time range is associated with the time range, a certain function can be effective within this time range.

↳ Periodic Time

Periodic time refers to a periodical interval in the time range. For example, "from 8:00 every Monday to 17:00 every Friday" is a typical periodic time interval. When a time-based application is associated with the time range, a certain function can be effective periodically from every Monday to Friday.

Features

| Feature | Function |
|---|---|
| Using Absolute Time Range | Sets an absolute time range for a time-based application, so that a certain function takes effect within the absolute time range. |
| Using Periodic Time | Sets periodic time or a time-based application, so that a certain function takes effect within the periodic time. |

15.3.1 Using Absolute Time Range

Working Principle

When a time-based application enables a certain function, it determines whether current time is within the absolute time range. If yes, the function is effective or ineffective at the current time depending on specific configuration.

Related Configuration

↳ Configuring Time Range

No time range is configured by default.

Use the **time-range** *time-range-name* command to configure a time range.

↘ **Configuring Absolute Time Range**

The absolute time range is [00:00 January 1, 0, 23:59 December 31, 9999] by default.

Use the **absolute** { [start time date] | [end time date] } command to configure the absolute time range.

15.3.2 Using Periodic Time

Working Principle

When a time-based application enables a certain function, it determines whether current time is within the period time. If yes, the function is effective or ineffective at the current time depending on specific configuration.

Related Configuration

↘ **Configuring Time Range**

No time range is configured by default.



Use the **time-range** *time-range-name* command to configure a time range.

↘ **Configure Periodic Time**

No periodic time is configured by default.

Use the **periodic** *day-of-the-week time to* [day-of-the-week] *time* command to configure periodic time.

15.4 Configuration Details

| Configuration Item | Suggestions and Related Commands | |
|--|---|------------------------------------|
| Configuring Time Range |  Mandatory configuration. Time range configuration is required so as to use the time range function. | |
| | time-range <i>time-range-name</i> | Configures a time range. |
| |  Optional configuration. You can configure various parameters as necessary. | |
| | absolute { [start time date] [end time date] } | Configures an absolute time range. |
| | periodic <i>day-of-the-week time to</i> [day-of-the-week] <i>time</i> | Configures periodic time. |

15.4.1 Configuring Time Range

Configuration Effect

- Configure a time range, which may be an absolute time range or a periodic time interval, so that a time-range-based application can enable a certain function within the time range.

Configuration Method

▾ Configuring Time Range

- Mandatory configuration.
- Perform the configuration on a device to which a time range applies.

▾ Configuring Absolute Time Range

- Optional configuration.

▾ Configuring Periodic Time

- Optional configuration.

Verification

- Use the **show time-range** [*time-range-name*] command to check time range configuration information.

Related Commands

▾ Configuring Time Range

| | |
|------------------------------|--|
| Command Syntax | time-range <i>time-range-name</i> |
| Parameter Description | <i>time-range-name</i> : name of the time range to be created. |
| Command Mode | Global configuration mode |
| Usage Guide | Some applications (such as ACL) may run based on time. For example, an ACL can be effective within certain time ranges of a week. To this end, first you must configure a time range, then you can configure relevant time control in time range configuration mode. |

▾ Configuring Absolute Time Range

| | |
|------------------------------|---|
| Command Syntax | absolute { [start <i>time date</i>] [end <i>time date</i>] } |
| Parameter Description | start <i>time date</i> : start time of the range. end <i>time date</i> : end time of the range. |
| Command Mode | Time range configuration mode |
| Usage Guide | Use the absolute command to configure a time absolute time range between a start time and an end time to allow a certain function to take effect within the absolute time range. |

▾ Configuring Periodic Time

| | |
|-----------------------|---|
| Command Syntax | periodic <i>day-of-the-week time to</i> [<i>day-of-the-week</i>] <i>time</i> |
|-----------------------|---|

| | |
|---------------------|--|
| Parameter | <i>day-of-the-week</i> : the week day when the periodic time starts or ends |
| Description | <i>time</i> : the exact time when the periodic time starts or ends |
| Command Mode | Time range configuration mode |
| Usage Guide | Use the periodic command to configure a periodic time interval to allow a certain function to take effect within the periodic time. |

15.5 Monitoring and Maintaining Time Range

[Displaying the Running Status](#)

| Function | Command |
|------------------------------------|---|
| Displays time range configuration. | show time-range [<i>time-range-name</i>] |

Specifications and Limitations

This section lists the specifications and limitations of features supported on AP products.

| Feature | Description |
|--------------|--|
| Interface | AP840-I products do not support the 5G wired port. |
| WLAN-WBS | <ol style="list-style-type: none">PoE power supply negotiation is supported on AP840-I.The poeout command is supported only on the AP840-I product. The poeout default running on the AP840-I product indicates disabling external power supply.The default bandwidth of AP840-I is 40MHz.AP840-I products support 802.11ax.AP840-I products do not support the Pre-ax function.AP840-I products do not support the CCA-ED function.AP840-I products do not support the downlink MU-MIMO function. |
| CWMP | The CWMP function is supported on AP840-I. |
| PPPOE-CLIENT | The PPPoE client function is supported on AP840-I. |
| NAT | The NAT function is supported on AP840-I. |