



**Ruijie RG-S1920 Series Switches**

**Hardware Installation and Reference Guide V1.11**

## **Copyright Statement**

Ruijie Networks©2019

Ruijie Networks reserves all copyrights of this document. Any reproduction, excerpt, backup, modification, transmission, translation or commercial use of this document or any portion of this document, in any form or by any means, without the prior written consent of Ruijie Networks is prohibited.

## **Exemption Statement**

This document is provided "as is". The contents of this document are subject to change without any notice. Please obtain the latest information through the Ruijie Networks website. Ruijie Networks endeavors to ensure content accuracy and will not shoulder any responsibility for losses and damages caused due to content omissions, inaccuracies or errors.

## Preface

Thank you for using our products. This manual will guide you through the installation of the device.

This manual describes the functional and physical features and provides the device installation steps, hardware troubleshooting, module technical specifications, and specifications and usage guidelines for cables and connectors.

## Audience

It is intended for the users who have some experience in installing and maintaining network hardware. At the same time, it is assumed that the users are already familiar with the related terms and concepts.

## Obtaining Technical Assistance

- Ruijie Networks Website: <https://www.ruijienetworks.com/>
- Technical Support Website: <https://ruijienetworks.com/support>
- Case Portal: <https://caseportal.ruijienetworks.com>
- Community: <https://community.ruijienetworks.com>
- Technical Support Email: [service\\_rj@ruijienetworks.com](mailto:service_rj@ruijienetworks.com)
- Skype: [service\\_rj@ruijienetworks.com](https://www.skype.com/people/service_rj@ruijienetworks.com)

## Related Documents

Documents	Description
Configuration Guide	Describes network protocols and related mechanisms that supported by the product, with configuration examples.
Command Reference	Describes the related configuration commands, including command modes, parameter descriptions, usage guides, and related examples.

## Symbol Conventions

The symbols used in this document are described as below:

---

 This symbol brings your attention to some helpful suggestions and references.

---

 This symbol means that you must be extremely careful not to do some things that may damage the device or cause data loss

---

# 1 Product Overview

Table 1-1 RG-S1920

Model	10/100 Base-T Auto-sensing Ethernet Port	10/100/1000 Base-T Auto-sensing Ethernet Port	1000Base-X SFP Port	Console Port
RG-S1920-18GT2SFP	\	18	2	1
RG-S1920-24GT4SFP/2GT	\	26	4 (Ports 25-26 are Combo ports)	1

**i** The SFP ports are downward compatible with 100Base-FX. The application of 100Base-FX requires 100M SFP modules.

**i** 1000Base-T is compatible with 100Base-TX and 10Base-T in the downlink direction.



## 1.1 RG-S1920-18GT2SFP

### Technical Specifications

<b>Model</b>	RG-S1920-18GT2SFP
<b>CPU</b>	Built-in CPU, single-core processor, 500MHz
<b>Flash Memory</b>	32MB
<b>SDRAM</b>	DDRIII 256MB
<b>Optical Module</b>	For details, see Appendix B. (Copper cables are not supported.) <b>i</b> The supported module type may change at any time. Consult us for the latest information.
<b>SFP Port</b>	Supports 1000Base-X and 100Base-FX modules.
<b>Power Supply</b>	<ul style="list-style-type: none"> <li>● AC input</li> </ul> Rated voltage range: 100V to 240V Maximum voltage range: 90V to 264V Frequency: 50/60 Hz Rated current: 0.6A  <ul style="list-style-type: none"> <li>● Power cord specification: 10A power cord</li> </ul>
<b>EEE</b>	Supported
<b>PoE</b>	Not supported
<b>Power Consumption</b>	< 17 W
<b>Operating Temperature</b>	-5°C to 55°C (23°F to 131°F)
<b>Storage Temperature</b>	-40°C to 70°C (-40°F to 158°F)

<b>Operating Humidity</b>	10% to 90% RH
<b>Storage Humidity</b>	5% to 95% RH
<b>Fan</b>	Not supported
<b>Temperature Warning</b>	Not supported
<b>Collecting Information of SFP Modules</b>	Not supported
<b>EMC Standards</b>	GB9254-2008
<b>Security Standards</b>	GB4943-2011
<b>Input Leakage Current</b>	≤ 1.5mA
<b>Dimensions (W x D x H)</b>	440 mm x 189 mm x 43.6 mm
<b>Weight</b>	2.4 kg (with package)

 The RG-S1920-18GT2SFP switch is a class A product. In a domestic environment, this product may cause radio interference in which case the user may be required to take adequate measures.

 The  label indicates that you should not touch the device when it operates in environments of more than 50°C (122°F).

### Product Appearance

On the front panel, the RG-S1920-18GT2SFP Ethernet switch provides 18 10/100/1000Base-T Ethernet ports, 2 SFP ports and 1 Console port. On the back panel, it provides AC power ports.

Figure 1-1 Appearance of RG-S1920-18GT2SFP

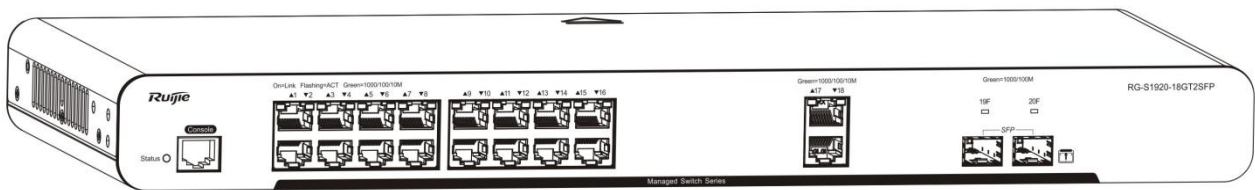

### Front Panel

Figure 1-2 Front Panel of RG-S1920-18GT2SFP

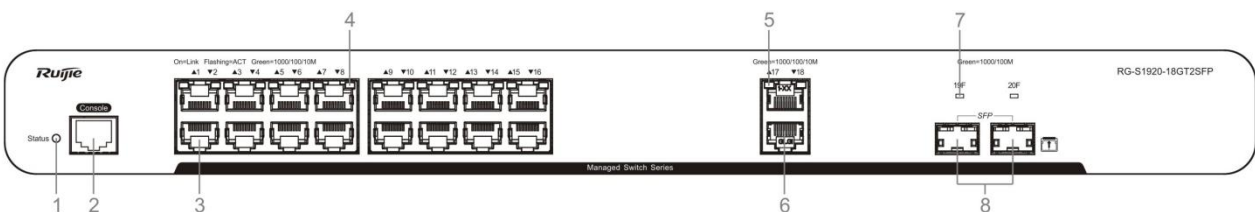

Note	1. System status LED	5. Copper port status LED
	2. Console port	6. 10/100/1000Base-T auto-sensing Ethernet port
	3. 10/100/1000Base-T auto-sensing Ethernet port	7. SFP port status LED
	4. Copper port status LED	8. 1000Base-X SFP port

### Back Panel

Figure 1-3 Back Panel of RG-S1920-18GT2SFP

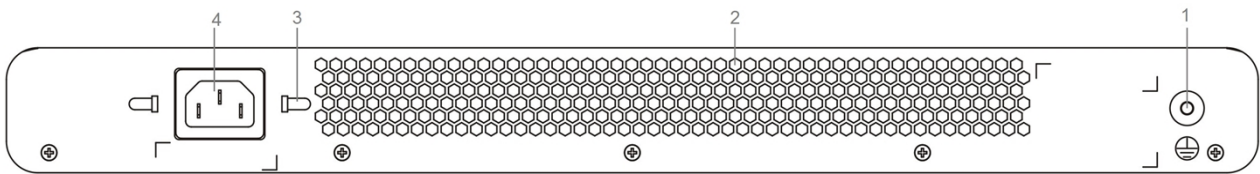

Note	1. Grounding pole	3. Power cord retention clip
	2. Vent	4. AC power port

### Heat Dissipation

The RG-S1920-18GT2SFP adopts natural heat dissipation, thereby ensuring normal function of the device in the specified environment. 10 cm distance space should be reserved at both sides and the back plane of the cabinet to allow air circulation. It is recommended to clean the device once every 3 months to avoid dust from blocking vents.

### LEDs

LED	Panel Identification	State	Meaning
System status LED	Status	Off	The switch is not receiving power.
		Blinking green	The system is being initialized. Continuous blinking indicates errors.
		Solid green	The switch is operational.
1000Mbps RJ-45 port status LED	1-18	Off	The port is not connected.
		Solid green	The port is connected at 10/100/1000 Mbps.

		Blinking green	The port is receiving or transmitting traffic at 10/100/1000 Mbps.
1000Mbps SFP port status LED	19F-20F	Off	The port is not connected.
		Solid green	The port is connected at 100/1000 Mbps.
		Blinking green	The port is receiving or transmitting traffic at 100/1000 Mbps.

## 1.2 RG-S1920-24GT4SFP/2GT

### Technical Specifications

<b>Model</b>	RG-S1920-24GT4SFP/2GT
<b>CPU</b>	Built-in CPU, single-core processor, 500MHz
<b>Flash Memory</b>	32MB
<b>SDRAM</b>	DDRIII 256MB
<b>Optical Module</b>	For details, see Appendix B. (Copper cables are not supported.)  The supported module type may change at any time. Consult us for the latest information.
<b>SFP Port</b>	Supports 1000Base-X and 100Base-FX modules.
<b>Power Supply</b>	<ul style="list-style-type: none"> <li>AC input</li> </ul> <p>Rated voltage range: 100 V to 240 V Maximum voltage range: 90 V to 264 V Frequency: 50/60 Hz Rated current: 0.6 A</p> <ul style="list-style-type: none"> <li>Power cord specification: 10 A power cord</li> </ul>
<b>EEE</b>	Supported
<b>PoE</b>	Not supported
<b>Power Consumption</b>	< 22W
<b>Operating Temperature</b>	-5°C to 55°C (23°F to 131°F)
<b>Storage Temperature</b>	-40°C to 70°C (-40°F to 158°F)
<b>Operating Humidity</b>	10% to 90% RH
<b>Storage Humidity</b>	5% to 95% RH
<b>Fan</b>	Not supported
<b>Temperature Warning</b>	Not supported
<b>Collecting</b>	Not supported

<b>Information of SFP Modules</b>	
<b>EMC Standards</b>	GB9254-2008
<b>Security Standards</b>	GB4943-2011
<b>Input Leakage Current</b>	≤ 1.5 mA
<b>Dimensions (W x D x H)</b>	440 mm x 189 mm x 43.6 mm
<b>Weight</b>	2.4 kg (with package)

**!** The RG-S1920-24GT4SFP/2GT switch is a class A product. In a domestic environment, this product may cause radio interference in which case the user may be required to take adequate measures.

**!** The  label indicates that you should not touch the device when it operates in environments of more than 50°C (122°F).

### Product Appearance

On the front panel, the RG-S1920-24GT4SFP/2GT Ethernet switch provides 24 10/100/1000Base-T Ethernet ports, 2 1000M Combo ports, 2 1000M SFP ports and 1 Console port. On the back panel, it provides AC power ports.

Figure 1-4 Appearance of RG-S1920-24GT4SFP/2GT

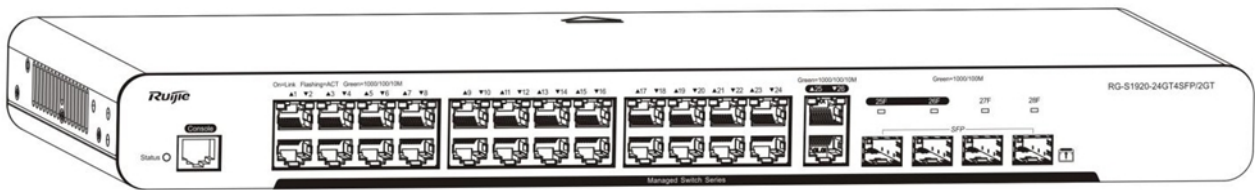

### Front Panel

Figure 1-5 Front Panel of RG-S1920-24GT4SFP/2GT

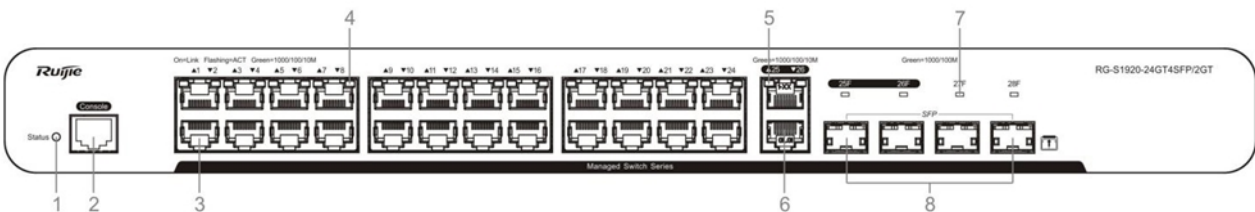

Note	1. System status LED	5. Copper port status LED
	2. Console port	6. 10/100/1000Base-T auto-sensing Ethernet port
	3. 10/100/1000Base-T auto-sensing Ethernet port	7. SFP port status LED
	4. Copper port status LED	8. 1000Base-X SFP port



### Back Panel

Figure 1-6 Back Panel of RG-S1920-24GT4SFP/2GT

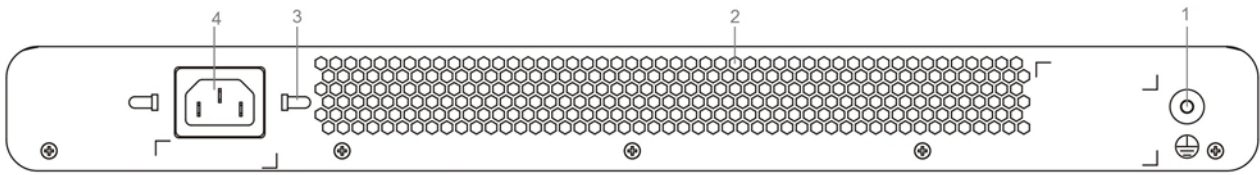

Note	1. Grounding pole	3. Power cord retention clip
	2. Vent	4. AC power port

### Heat Dissipation

The RG-S1920-24GT4SFP/2GT adopts natural heat dissipation, thereby ensuring normal function of the device in the specified environment. 10 cm distance space should be reserved at both sides and the back plane of the cabinet to allow air circulation. It is recommended to clean the device once every 3 months to avoid dust from blocking vents.

### LEDs

LED	Panel Identification	State	Meaning
System status LED	Status	Off	The switch is not receiving power.
		Blinking green	The system is being initialized. Continuous blinking indicates errors.
		Solid green	The switch is operational.
1000Mbps RJ-45 port status LED	1-26	Off	The port is not connected.
		Solid green	The port is connected at 10/100/1000 Mbps.
		Blinking green	The port is receiving or transmitting traffic at 10/100/1000 Mbps.
1000Mbps SFP port status LED	25F-28F	Off	The port is not connected.
		Solid green	The port is connected at 100/1000 Mbps.
		Blinking green	The port is receiving or transmitting traffic at 100/1000 Mbps.

## 2 Preparation before Installation

### 2.1 Safety Suggestions

---

 To avoid personal injury and equipment damage, please carefully read the safety suggestions before you install the RG-S1920 series switch.

The following safety suggestions do not cover all possible dangers.

---

#### 2.1.1 Installation

- Keep the chassis clean and free from any dust.
- Do not place the equipment in a walking area.
- Do not wear loose clothes or accessories that may be hooked or caught by the device during installation and maintenance.
- Turn off all power supplies and remove the power sockets and cables before installing or uninstalling the device.

#### 2.1.2 Movement

- Do not frequently move the device.
- When moving the device, note the balance and avoid hurting legs and feet or straining the back.
- Before moving the device, turn off all power supplies and dismantle all power modules.

#### 2.1.3 Electricity

- Observe local regulations and specifications when performing electric operations. Relevant operators must be qualified.
- Before installing the device, carefully check any potential danger in the surroundings, such as ungrounded power supply, and damp/wet ground or floor.
- Before installing the device, find out the location of the emergency power supply switch in the room. First cut off the power supply in the case of an accident.
- Try to avoid maintaining the switch that is powered-on alone.
- Be sure to make a careful check before you shut down the power supply.
- Do not place the equipment in a damp location. Do not let any liquid enter the chassis.

---

 Any nonstandard and inaccurate electric operation may cause an accident such as fire or electrical shock, thus causing severe even fatal damages to human bodies and equipment.

 Direct or indirect touch through a wet object on high-voltage and mains supply may bring a fatal danger.

 If a power supply system is equipped with a leakage protector (also referred to as "leakage current switch" or "leakage current breaker"), the rated leakage action current of each leakage protector is greater than twice of the theoretical maximum leakage current of all the power supplies in the system. For example, if a system is equipped with 20 identical power supplies, the leakage current of each power supply is equal to or less than 1.5mA, and the

leakage current of the system totals 30mA. A leakage protector with 30mA rated action current supports less than 10 power supplies (that is, Action current of the leakage protector/2/Maximum leakage current of each power supply = $30/2/1.5=10$ ). In other words, the leakage protector with 30mA rated action current supports no more than 10 power supplies. In this case, the 20 power supplies in the system require at least 2 leakage protectors with 30mA rated action current and each leakage protector supports 10 power supplies. If power supplies in a system differ in models, the rated leakage action current of each leakage protector divided by two is greater than the sum of maximum leakage current of all the power supplies. The rated leakage non-action current of a leakage protector shall be 50% of the leakage action current. Take a leakage protector with 30mA rated leakage action current as an example. The rated leakage non-action current shall be 15mA. When the leakage current is below 15mA, the protector shall not act. Otherwise, misoperation may easily occur due to high sensitivity and thus the leakage protector trips, devices are powered off, and services are interrupted.

 To guarantee personal safety, the rated leakage action current of each leakage protector in the system must be equal to or less than 30mA (human body safety current is 30mA). When twice of the total leakage current of the system is greater than 30mA, the system must be equipped with two or more leakage protectors.

 For the leakage current value of each power supply model, see the power supply model parameter table in Chapter 1.

---

## 2.1.4 Static Discharge Damage Prevention

To prevent damage from static electricity, pay attention to the following:

- Proper grounding of grounding screws on the back panel of the device. Use of a three-wire single-phase socket with protective earth wire (PE) as the AC power socket.
- Indoor dust prevention
- Proper humidity conditions

## 2.1.5 Laser

The RG-S1920 series switch supports varying models of optical modules sold on the market which are Class I laser products. Improper use of optical modules may cause damage. Therefore, pay attention to the following when you use them:

- When a fiber transceiver works, ensure that the port has been connected with an optical fiber or is covered with a dust cap, to keep out dust and avoid burning your eyes.
- When the optical module is working, do not pull out the fiber cable and stare into the transceiver interface or you may hurt your eyes.

 Do not stare into any optical port under any circumstances, as this may cause permanent damage to your eyes.

---

## 2.2 Installation Site Requirements

To ensure the normal working and a prolonged durable life of the equipment, the installation site must meet the following requirements.

## 2.2.1 Ventilation

For the RG-S1920, a sufficient space (at least 10 cm distances from both sides and the back plane of the cabinet) should be reserved at the ventilation openings to ensure the normal ventilation. After various cables have been connected, they should be arranged into bundles or placed on the cabling rack to avoid blocking the air inlets. It is recommended to clean the switch at regular intervals (like once every 3 months). Especially, avoid dust from blocking the screen mesh on the back of the cabinet.

## 2.2.2 Temperature and Humidity

To ensure the normal operation and prolong the service life of RG-S1920 series switch, you should keep proper temperature and humidity in the equipment room.

If the equipment room has temperature and humidity that do not meet the requirements for a long time, the equipment may be damaged.

- In an environment with high relative humidity, the insulating material may have bad insulation or even leak electricity. Sometimes the materials may suffer from mechanical performance change and metallic parts may get rusted.
- In an environment with low relative humidity, however, the insulating strip may dry and shrink. Static electricity may occur easily and endanger the circuit on the equipment.
- In an environment with high temperature, the equipment is subject to even greater harm, as its performance may degrade significantly and various hardware faults may occur.

Therefore, the ambient temperature and humidity of the RG-S1920 series must meet the requirements listed in Table 2-1:

Table 2-1 Temperature and Humidity Requirements of the RG-S1920 Series Switch

Temperature	Relative Humidity
-5°C to 55°C (23°F to 131°F)	10% to 90%

**i** The requirements for the sampling site of the temperature and humidity in the operating environment of the device are as follows:

There is no protective plate at the front or back of the equipment rack.

The vertical height is 1.5 m above the floor.

The distance from the front panel of the equipment is 0.4 m.

## 2.2.3 Cleanness

Dust poses a severe threat to the running of the equipment. The indoor dust falling on the equipment may be adhered by the static electricity, causing bad contact of the metallic joint. Such electrostatic adherence may occur more easily when the relative humidity is low, not only affecting the useful life of the equipment, but also causing communication faults.

Table 2-2 shows the requirements for the dust content and granularity in the equipment room.

Table 2-2 Requirements for the Dust Content and Granularity in the Equipment Room

Dust	Unit	Density
Diameter $\geq 0.5 \mu\text{m}$	Particles/m <sup>3</sup>	$\leq 3.5 \times 10^6$
Diameter $\geq 5 \mu\text{m}$	Particles/m <sup>3</sup>	$\leq 3 \times 10^4$

Apart from dust, the salt, acid and sulfide in the air in the equipment room must also meet strict requirements, as such poisonous substances may accelerate the corrosion of the metal and the aging of some parts. The equipment room should be protected from the intrusion of harmful gases such as sulfur dioxide, sulfured hydrogen, nitrogen dioxide, and chlorine), whose requirements are listed in Table 2-3.

Table 2-3 Requirements for Harmful Gases in the Equipment Room

Gas	Average (mg/m <sup>3</sup> )	Maximum (mg/m <sup>3</sup> )
SO <sub>2</sub>	0.3	1.0
H <sub>2</sub> S	0.1	0.5
NO <sub>2</sub>	0.5	1.0
Cl <sub>2</sub>	0.1	0.3

-  Both average and maximum value are measured for a week. The switch cannot be placed in the environment with the maximum density for over 30 minutes every day.







## 2.2.4 Grounding

A good grounding system is the basis for the stable and reliable operation of the RG-S1920 series switch. It is the chief condition to prevent lightning stroke and resist interference. Please carefully check the grounding conditions on the installation site according to the grounding requirements, and perform grounding operations properly as required.

-  Effective grounding of the switch is an important guarantee for lightning protection and interference resistance. Therefore, connect the grounding line of the switch properly.

### Safety Grounding

The equipment using AC power supply must be grounded by using the yellow/green safety grounding cable. Otherwise, when the insulating resistance decreases the power supply and the enclosure in the equipment, electric shock may occur.

-  The building must provide protective grounding connection to ensure that the device is connected to the protection location.
-  The installation and maintenance personnel must check whether the A.C. socket is well connected to the protection location of the building, if not, they should use a protective grounding wire to connect the grounding end of the A.C. socket to the building's protection location.
-  The power supply socket must be installed in a place that is near to the device and where users can operate the device easily.
-  Before the installation of the device, make sure that ground connection is connected at first and disconnected finally.
-  The sectional area of the protective grounding wire should be at least 0.75 mm<sup>2</sup> (18 AWG).
-  Use the 3-core power supply line. The sectional area of each pin should be at least 0.75 mm<sup>2</sup> or 18 AWG.

### Lightning Grounding

The lightning protection system of a facility is an independent system that consists of the lightning rod, downlead conductor and the connector to the grounding system, which usually shares the power reference ground and yellow/green safety cable ground. The lightning discharge ground is for the facility only, irrelevant to the equipment.

### EMC Grounding

The grounding required for EMC design includes shielding ground, filter ground, noise and interference suppression, and level reference. All the above constitute the comprehensive grounding requirements. The resistance of earth wires should be less than 1 ohm. The RG-S1920 series switch back plane is reserved with one grounding pole, as shown in Figure 2-1.

Figure 2-1 Grounding of RG-S1920

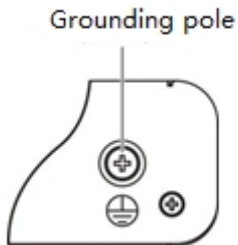

## 2.2.5 Lightning Resistance

When the AC power cable is imported outdoors and directly connected to the power port of the RG-S1920 series switch, lightning line bank should be adopted to prevent the switch from being hit by lightning shocks. Usage of the lightning line bank: Connect the mains supply AC cable to the lightning line bank. Then, connect the switch to the lightning line bank. This can help to prevent the current of high-voltage lightning from passing the switch directly through the mains supply cable to a certain extent.

- 
- i** The lightning line banks are not provided and should be purchased by users as required.  
For the usage of lightning line banks, refer to their related manuals.
- 

## 2.2.6 EMI

Electro-Magnetic Interference (EMI), from either outside or inside the equipment or application system, affects the system in the conductive ways such as capacitive coupling, inductive coupling, and electromagnetic radiation.

There are two types of electromagnetic interference: radiated interference and conducted interference, depending on the type of the transmission path.

When the energy, often RF energy, from a component arrives at a sensitive component via the space, the energy is known as radiated interference. The interference source can be either a part of the interfered system or a completely electrically isolated unit. Conducted interference results from the electromagnetic wire or signal cable connection between the source and the sensitive component, along which cable the interference conducts from one unit to another. Conducted interference often affects the power supply of the equipment, but can be controlled by a filter. Radiated interference may affect any signal path in the equipment and is difficult to shield.

- For the AC power supply system TN, single-phase three-core power socket with protective earthing conductors (PE) should be adopted to effectively filter out interference from the power grid through the filtering circuit.
- The grounding device of the switch must not be used as the grounding device of the electrical equipment or anti-lightning grounding device. In addition, the grounding device of the switch must be deployed far away from the grounding device of the electrical equipment and anti-lightning grounding device.
- Keep the equipment away from high-power radio transmitter, radar transmitting station, and high-frequency large-current device.
- Measures must be taken to shield static electricity.

- Interface cables should be laid inside the equipment room. Outdoor cabling is prohibited, avoiding damages to device signal interfaces caused by over-voltage or over-current of lightning.

## 2.3 Requirements of Installation Tools

Table 2-4 List of Installation Tools

<b>Common Tools</b>	Phillips screwdriver, flathead screwdriver, related electric cables and optical cables, bolts, diagonal pliers, straps
<b>Special Tools</b>	Anti-static tools
<b>Meters</b>	Multimeter

---

 The tool kit is customer-supplied.

---

## 3 Product Installation

- i** Please ensure that you have carefully read Chapter 2.  
Make sure that the requirements set forth in Chapter 2 have been met.

### 3.1 Installation Flowchart

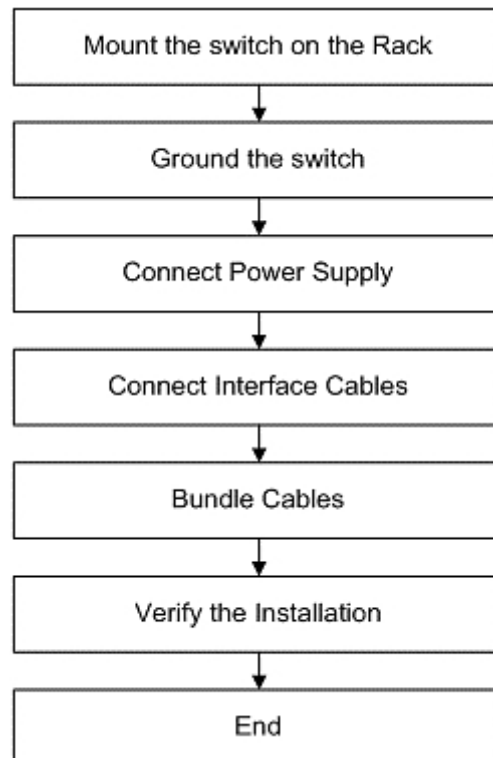

### 3.2 Confirmations before Installation

Before installation, please confirm the following points:

- Whether ventilation requirements are met for the switch
- Whether the requirements of temperature and humidity are met for the switch
- Whether power cables are already laid out and whether the requirements of electrical current are met
- Whether related network adaption lines are already laid out

### 3.3 Installing the RG-S1920

#### Precautions

During installation, note the following points:



- Connect the power cables of different colors to the corresponding grounding posts.
- Ensure that the interface of the power supply cable is well connected to the power interface of the device. The power cables must be protected using power cable retention clips after they are connected to the device.
- Do not place any articles on the RG-S1920 series switch.
- Reserve a spacing of at least 10 cm around the chassis for good ventilation. Do not stack the devices.
- The switch should be located at places free from the large power radio launch pad, radar launch pad, and high-frequency large-current devices. If necessary, electromagnetic shielding should be adopted. For example, use interface cables to shield cables.
- 100-meter network cables should be laid inside the equipment room and outdoor cabling of such cables is prohibited. If outdoor cabling is necessary, take relevant measures for lightning protection.

### 3.3.1 Mounting the Switch to a Standard 19-inch Rack

The RG-S1920 series switches follow the EIA standard dimensions and can be installed in 19-inch distribution cabinets.

Attach the mounting brackets to the switch with the supplied screws, as shown in Figure 3-1 .

Figure 3-1 Attaching the Mounting Bracket to the Switch (RG-S1920-18GT2SFP and RG-S1920-24GT4SFP/2GT)

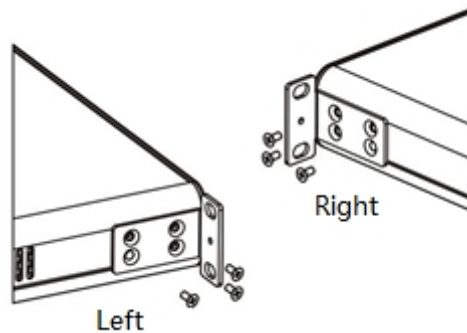

Align the mounting holes in the mounting bracket with the mounting holes in the rack, as shown in Figure 3-2.

Figure 3-2 Aligning the Mounting Holes (RG-S1920-18GT2SFP and RG-S1920-24GT4SFP/2GT)

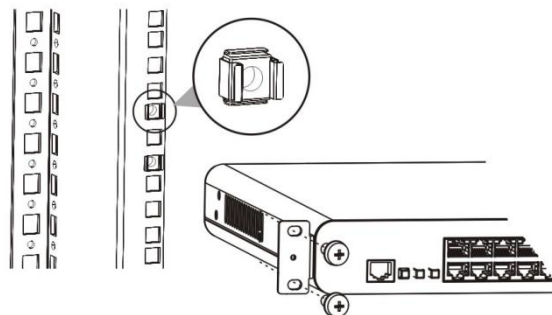

Use the supplied M6 screws and cage nuts to securely attach the mounting brackets to the rack, as shown in Figure 3-3.

Figure 3-3 Attaching the Mounting Brackets to the Rack (RG-S1920-18GT2SFP and RG-S1920-24GT4SFP/2GT)

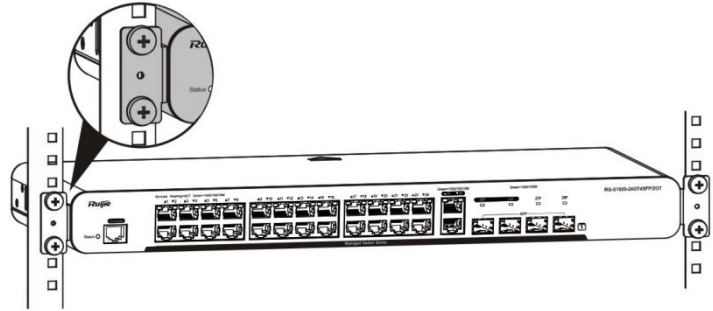

### 3.3.2 Mounting the Switch on the Wall

The RG-S1920 series switch can be mounted on the wall, as shown in the following figures.

Attach the mounting brackets to the switch with the supplied screws, as shown in Figure 3-4.

Figure 3-4 Attaching the Mounting Brackets to the Switch for Wall-Mounting (RG-S1920-18GT2SFP and RG-S1920-24GT4SFP/2GT)

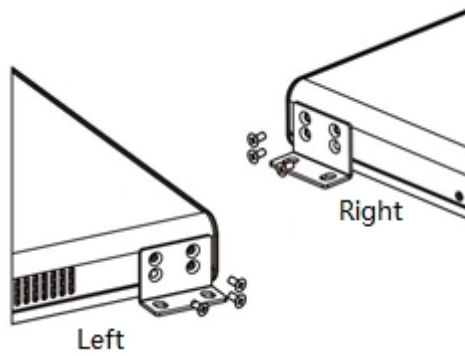

Use the expansion screws to securely attach the mounting brackets on the wall, as shown in Figure 3-5.

Figure 3-5 Attaching the Switch on the Wall (RG-S1920-18GT2SFP and RG-S1920-24GT4SFP/2GT)

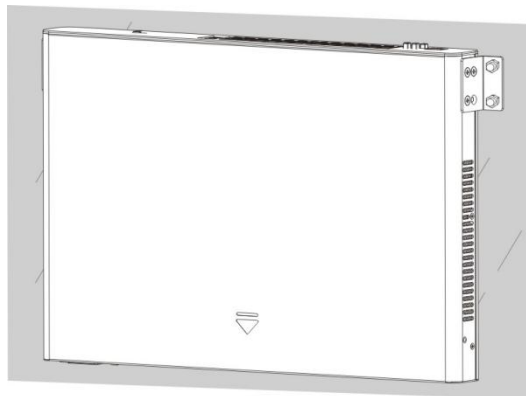

**⚠** SUITABLE FOR MOUNTING ON CONCRETE OR OTHER NON-COMBUSTIBLE SURFACE ONLY.

### 3.3.3 Mounting the Switch on a Table

Attach the four rubber feet to the recessed areas on the bottom of the switch, as shown in Figure 3-6.

Figure 3-6 Attaching the Rubber Feet to the Recessed Areas

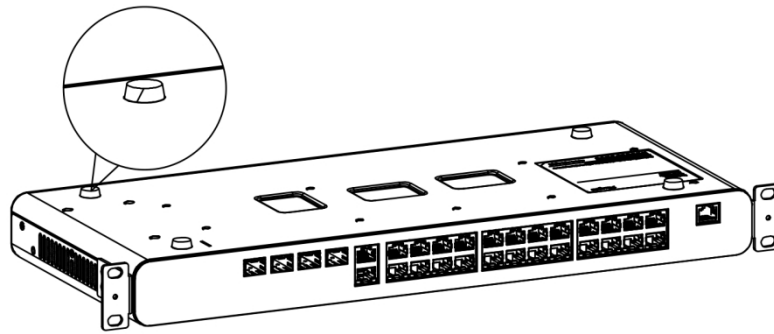

Place the switch on the table, as shown in Figure 3-7.

Figure 3-7 Mounting the Switch on the Table

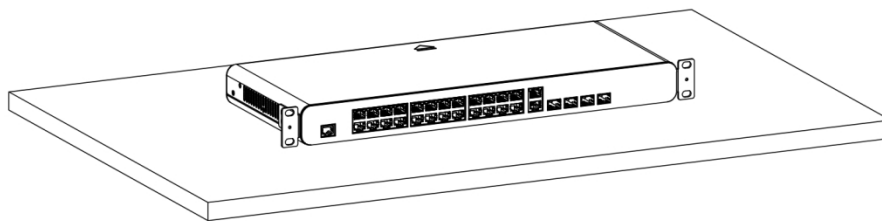

The device must be installed and operated in the place that can restrict its movement.

### 3.4 Checking after Installation



Before checking the installation, switch off the power supply so as to avoid any personal injury or damage to the component due to connection errors.

- Check that the ground line is connected.
- Check that the cables and power input cables are correctly connected.
- Check that all interface cables are laid out inside the equipment room. In the case of external cabling, check that the lightning resistance socket or network interface lightning protector is connected.
- Check that sufficient airflow is available around the device (over 10 cm)

## 4 System Debugging

### 4.1 Establishing the Debugging Environment

#### Establishing the Debugging Environment

Connect the PC to the console port of the switch through the console cable, as shown in Figure 4-1.

Figure 4-1 Schematic Diagram of the Configuration Environment

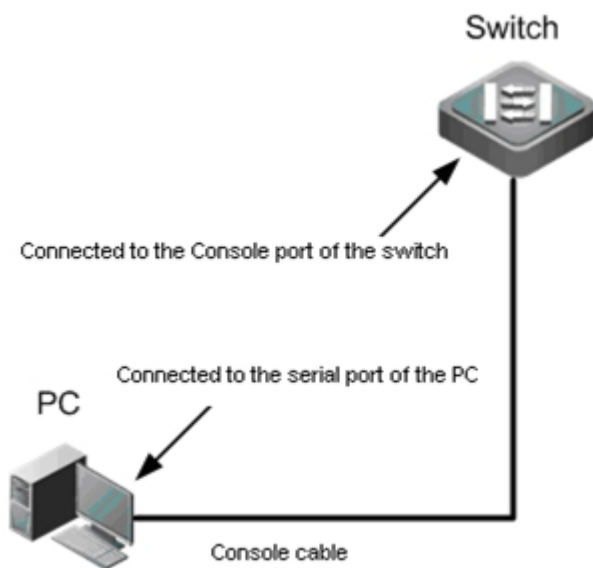

#### Connecting the Console Cable

- Step 1: Connect the end of the console cable with DB-9 jack to the serial port of the PC.
- Step 2: Connect the end of the console cable with RJ45 to the console port of the switch.

#### Setting HeparTerminal Parameters

- Step 1: Start the PC and run the terminal simulation program on the PC, such as Terminal on Windows 3.1 or HyperTerminal on Windows 95/98/NT/2000/XP.
- Step 2: Set terminal parameters. The parameters are as follows: baud rate 9600, data bit 8, parity check none, stop bit 1, and flow control as none.

Choose **Setup>Program>Attachment >Communication> Hyper Terminal**.

Choose **Cancel**, the interface as shown in Figure 4-2 is displayed.

Figure 4-2



Enter the name of the new connection and click **OK**, the interface as shown in Figure 4-3 is displayed. Choose the serial port used currently in the column [use when connecting].

Figure 4-3



After choosing the serial port, click **OK** to display the serial port parameter setting interface, set the baud rate to 9600, data bit to 8, parity check to none, stop bit to 1 and flow control to none.

Figure 4-4

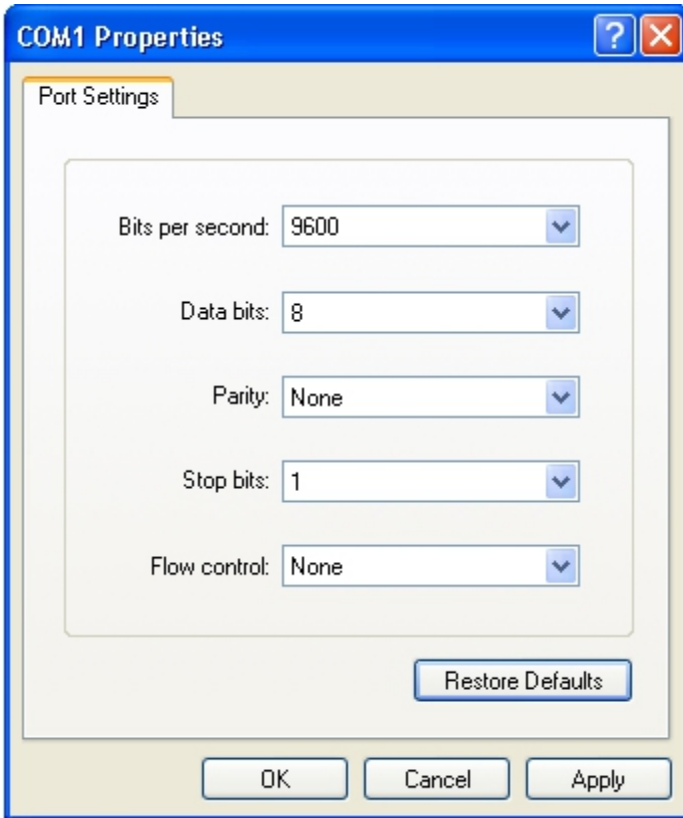

After setting the parameters, click **OK** to enter the hyper terminal interface.

## 4.2 Startup Check

### 4.2.1 Checking before the Device is Powered on

- The switch is fully grounded.
- The power cable is correctly connected.
- The power supply voltage complies with the requirement of the switch.
- The control cable of the PC is properly connected to the console port of the switch. The HyperTerminal is started and the parameter settings are correct.

### 4.2.2 Checking after Program Startup (Recommended)

After power-on, you are recommended to perform the following checks to ensure the normal operation of follow-up configurations.

- Check whether information is displayed on the terminal interface.
- Check whether the status of the switch indicator is normal.
- Check whether the main program of the device is normally loaded.
- Check whether the time on the device is consistent with the current Beijing time.

- Check whether the service interface forwards data normally.

## 5 Maintenance and Troubleshooting

### 5.1 General Troubleshooting Procedure

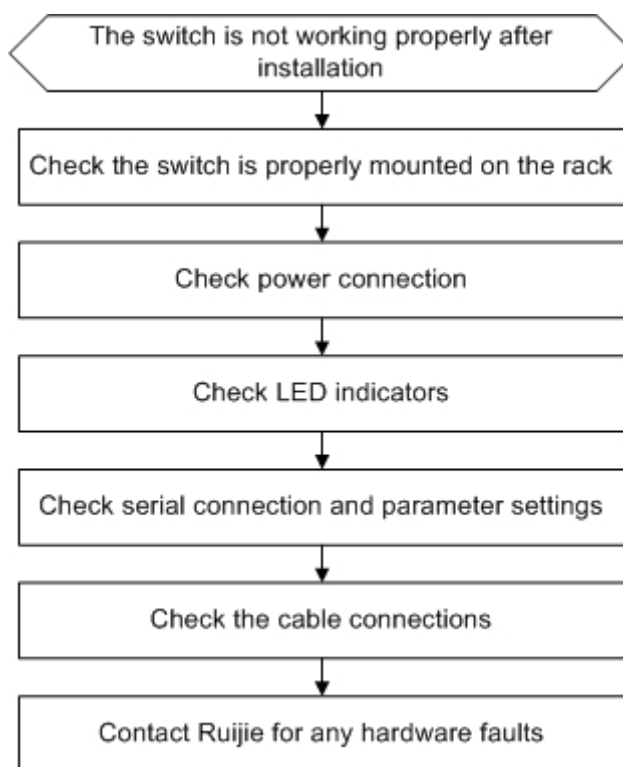

### 5.2 Troubleshooting Common Faults

Symptom	Possible Causes	Solution
Forgetting the management interface login password	A password is manually configured but it is forgotten.	Please contact Ruijie Networks Customer Service Department for technical support.
The status indicator is not on after the switch is started.	The power supply module does not supply power. The power cable is in loose contact.	Check whether the power socket at the equipment room is normal and whether the power cable of the switch is in good contact.
The serial port console has no output or outputs illegible characters.	The serial port connected to the switch does not match that opened by the configuration software. The serial port is not configured correctly.	Change the serial port opened by the configuration software to be the one connected to the switch. Check that the parameter configuration of the serial port matches that specified in the instructions.
The RJ45 port is not in connectivity or it is erroneous in	The connected twisted pair cable is faulty. The length of the cable exceeds 100 m.	Replace the twisted pair cable. Check that the port configuration has the common working mode with the connected switch.



receiving/transmitting frames.	The port has special configuration that has no common working mode with the connected switch.	
The fiber port cannot be connected.	<p>The Rx and Tx ends are connected reversely.</p> <p>The interconnected optical module type does not match.</p> <p>The fiber type is not correct.</p> <p>The length of the optical fiber exceeds that rated of the optical module.</p>	<p>Switch the Rx and Tx ends of the optical fiber.</p> <p>Replace the optical module with one of the matched type.</p> <p>Replace the optical fiber with one of the appropriate type.</p> <p>Replace the optical fiber with one of the appropriate length.</p>

## Appendix A: Connectors and Connection Media

### 1000BASE-T/100BASE-TX/10BASE-T Ports

The 1000BASE-T/100BASE-TX/10BASE-T is a port that supports adaptation of three rates, and automatic MDI/MDIX Crossover at these three rates.

The 1000BASE-T complies with IEEE 802.3ab, and uses the cable of 100-ohm Category-5 or Supper Category-5 UTP or STP, which can be up to 100 m.

The 1000BASE-T port uses four pairs of wires for transmission, all of which must be connected. Figure A-1 shows the connections of the twisted pairs used by the 1000BASE-T port.

Figure A-1 Four Twisted Pairs of the 1000BASE-T

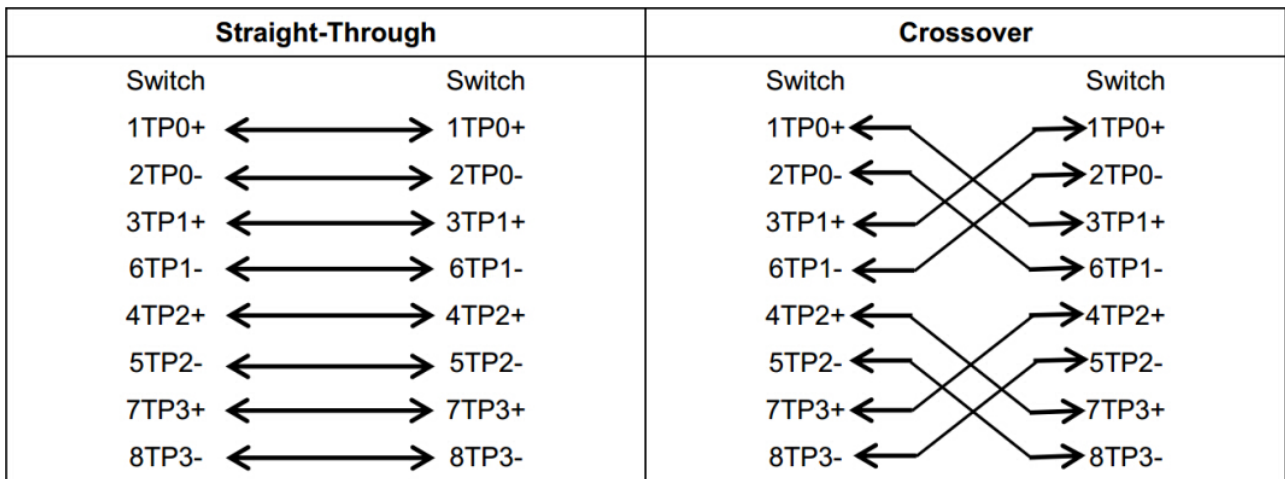

In addition to the above cables, the 100BASE-TX/10BASE-T can also use 100-ohm Category-3, 4, 5 cables for 10 Mbps, and 100-ohm Category-5 cables for 100 Mbps, both of which can be up to 100 m. Figure A-2 shows the pinouts of the 100BASE-TX/10BASE-T.

Figure A-2 Pinouts of the 100BASE-TX/10BASE-T

Pin	Socket	Plug
1	Input Receive Data+	Output Transmit Data+
2	Input Receive Data-	Output Transmit Data-
3	Output Transmit Data+	Input Receive Data+
6	Output Transmit Data-	Input Receive Data-
4,5,7,8	Not used	Not used

Figure A-3 shows the straight-through and crossover cable connections for the 100BASE-TX/10BASE-T.

Figure A-3 Connections of the Twisted Pairs of the 100BASE-TX/10BASE-T

Straight-Through		Crossover	
Switch	Adapter	Switch	Switch
1 IRD+	1 OTD+	1 IRD+ ←	1 IRD+ →
2 IRD-	2 OTD-	2 IRD- ←	2 IRD- →
3 OTD+	3 IRD+	3 OTD+ ←	3 OTD+ →
6 OTD-	6 IRD-	6 OTD- ←	6 OTD- →

**Optical Fiber Connection**

For the optical fiber ports, select single-mode or multiple-mode optical fibers for connection according to the fiber module connected. The connection schematic diagram is shown in Figure A-4:

Figure A-4 Optical Fiber Connections

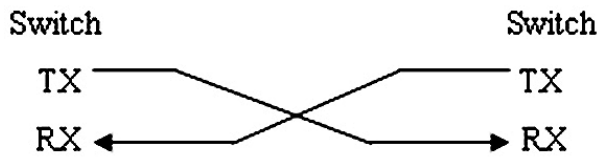

## Appendix B: Mini-GBIC Module

SFP modules (Mini-GBIC module) modules are available to address the requirements of interface types of switch modules. You can select the Mini-GBIC module to suit your specific needs. The models and technical specifications of some Mini-GBIC modules are listed below. For details, see *Ruijie Transceiver Installation and Reference Guide*.

**Table B-1 Models and Technical Specifications of the 1000M Mini-GBIC(SFP) Module**

Model	Wavelength (nm)	Fiber Type	Support DDM (Yes/No)	Sending Optical Density (dBm)		Receiving Optical Density (dBm)	
				min	max	min	max
FE-SFP-LX-MM1310	1310	MMF	Yes	-22	-14	-30	-14
FE-SFP-LX-MM1310-SGMII	1310	MMF	No	-20	-15	-28	-8
FE-SFP-LH15-SM1310	1310	SMF	Yes	-15	-8	-28	-8
FE-SFP-LH20-SM1310-SGMII	1310	SMF	No	-15	-8	-28	-8
FE-SFP-LX20-SM1310-BIDI	1310TX/1550RX	SMF	Yes	-15	-7	-28	-8
FE-SFP-LX20-SM1550-BIDI	1550TX/1310RX	SMF	Yes	-15	-7	-28	-8
FE-SFP-LH40-SM1310-BIDI	1310TX/1550RX	SMF	Yes	-7	-2	-32	-8
FE-SFP-LH40-SM1550-BIDI	1550TX/1310RX	SMF	Yes	-7	-2	-32	-8
FE-eSFP-LH15-SM1310	1310	SMF	Yes	-15	-8	-28	-8
Mini-GBIC-SX	850	MMF	No	-9.5	-3	-17	0
Mini-GBIC-LX	1310	SMF	No	-9.5	-3	-20	-3
GE-eSFP-SX-MM850	850	MMF	Yes	-9.5	-3	-17	0
GE-eSFP-LX-SM1310	1310	SMF	Yes	-9.5	-3	-20	-3
GE-SFP-LX-SM1310	1310	SMF	No	-9.5	-3	-20	-3
Mini-GBIC-LH40	1310	SMF	Yes	-2	3	-22	-3
GE-SFP-SX-SM1310-BIDI	1310	MMF	No	-10	-5	-17	-3
GE-SFP-SX-SM1550-BIDI	1550	MMF	No	-10	-5	-17	-3
GE-SFP-LX20-SM1310-BIDI	1310TX/1550RX	SMF	Yes	-9	-3	-20	-3
GE-SFP-LX20-SM1550-BIDI	1550TX/1310RX	SMF	Yes	-9	-3	-20	-3
GE-SFP-LH40-SM1310-BIDI	1310TX/1550RX	SMF	Yes	-5	0	-24	-1
GE-SFP-LH40-SM1550-BIDI	1550TX/1310RX	SMF	Yes	-5	0	-24	-1
Mini-GBIC-ZX50	1550	SMF	Yes	-5	0	-22	-3
Mini-GBIC-ZX80	1550	SMF	Yes	0	4.7	-22	-3



Mini-GBIC-ZX100	1550	SMF	Yes	0	5	-30	-9
SDH155-SFP-SX-MM850	850	MMF	No	-10	-4	-25	0
SDH155-SFP-SX-MM1310	1310	MMF	No	-20	-14	-30	-14
SDH155-SFP-LH15-SM1310	1310	SMF	No	-15	-8	-28	-8
SDH155-SFP-LH40-SM1310	1310	SMF	No	-5	0	-34	-8
SDH155-SFP-LH80-SM1550	1550	SMF	No	-5	0	-34	-8
GE-SFP-SX	850	MMF	No	-9.5	-3	-17	0
GE-SFP-LX	1310	SMF	No	-9.5	-3	-20	-3

**Table B-2 Models of 100M SFP Copper Module**

Standard	Model	DDM (Yes/No)
1000Base-T	Mini-GBIC-GT	No

**Table B-3 Module Cabling Specification**

Model	Connector Type	Fiber Type	Core Size(um)	Cabling Distance
Mini-GBIC-SX	LC	MMF	62.5/125	275m
			50/125	550m
Mini-GBIC-LX	LC	SMF	9/125	10km
GE-eSFP-SX-MM850	LC	MMF	62.5/125	275m
			50/125	550m
GE-eSFP-LX-SM1310	LC	SMF	9/125	10km
GE-SFP-LX-SM1310	LC	SMF	9/125	10km
Mini-GBIC-LH40	LC	SMF	9/125	40km
GE-SFP-SX-SM1310-BIDI	LC	MMF	50/125	500m
GE-SFP-SX-SM1550-BIDI	LC	MMF	50/125	500m
GE-SFP-LX20-SM1310-BIDI	LC	SMF	9/125	20km
GE-SFP-LX20-SM1550-BIDI	LC	SMF	9/125	20km
GE-SFP-LH40-SM1310-BIDI	LC	SMF	9/125	40km
GE-SFP-LH40-SM1550-BIDI	LC	SMF	9/125	40km
Mini-GBIC-ZX50	LC	SMF	9/125	50km
Mini-GBIC-ZX80	LC	SMF	9/125	80km
Mini-GBIC-ZX100	LC	SMF	9/125	100km
SDH155-SFP-SX-MM850	LC	MMF	62.5/125	500m
SDH155-SFP-SX-MM1310	LC	MMF	62.5/125	2km
SDH155-SFP-LH15-SM1310	LC	SMF	9/125	15km
SDH155-SFP-LH40-SM1310	LC	SMF	9/125	40km
SDH155-SFP-LH80-SM1310	LC	SMF	9/125	80km
GE-SFP-SX	LC	MMF	62.5/125	275m
			50/125	550m
GE-SFP-LX	LC	SMF	9/125	10km
Mini-GBIC-GT	RJ45	Category 5 (or above ) UTP or STP		100m

-  For the optical module with transmission distance exceeding 40 km and more, one on-line optical attenuator should be added on the link to avoid the overload of the optical receiver when short single-mode optical fibers are used.
-  Optical modules generate laser. Do not stare at light source.
-  To keep optical modules clean, please use dust caps when the modules are not connected with fibers.

**Table B-4 Specifications of SFP BIDI Optical Module Pairs**

Rate/Distance	Module Pairs
1000M/500m	GE-SFP-SX-SM1310-BIDI GE-SFP-SX-SM1550-BIDI
1000M/20km	GE-SFP-LX20-SM1310-BIDI GE-SFP-LX20-SM1550-BIDI
100M/40km	GE-SFP-LH40-SM1310-BIDI GE-SFP-LH40-SM1550-BIDI

-  The BIDI modules must be used in pairs (e.g., FE-SFP-LX20-SM1310-BIDI and FE-SFP-LX20-SM1550-BIDI).

## Appendix C: Lightning Protection

### Installing AC Power Arrester (lightning protection cable row)

The external lightning protection cable row shall be used on the AC power port to prevent the switch from being struck by lightning when the AC power cable is introduced from the outdoor and directly connected to the power port of the switch. The lightning protection cable row is fixed on the cabinet, operating table or the wall in the machine room using the line buttons and screws.

Figure C-1 Schematic Diagram for the Power Arrester

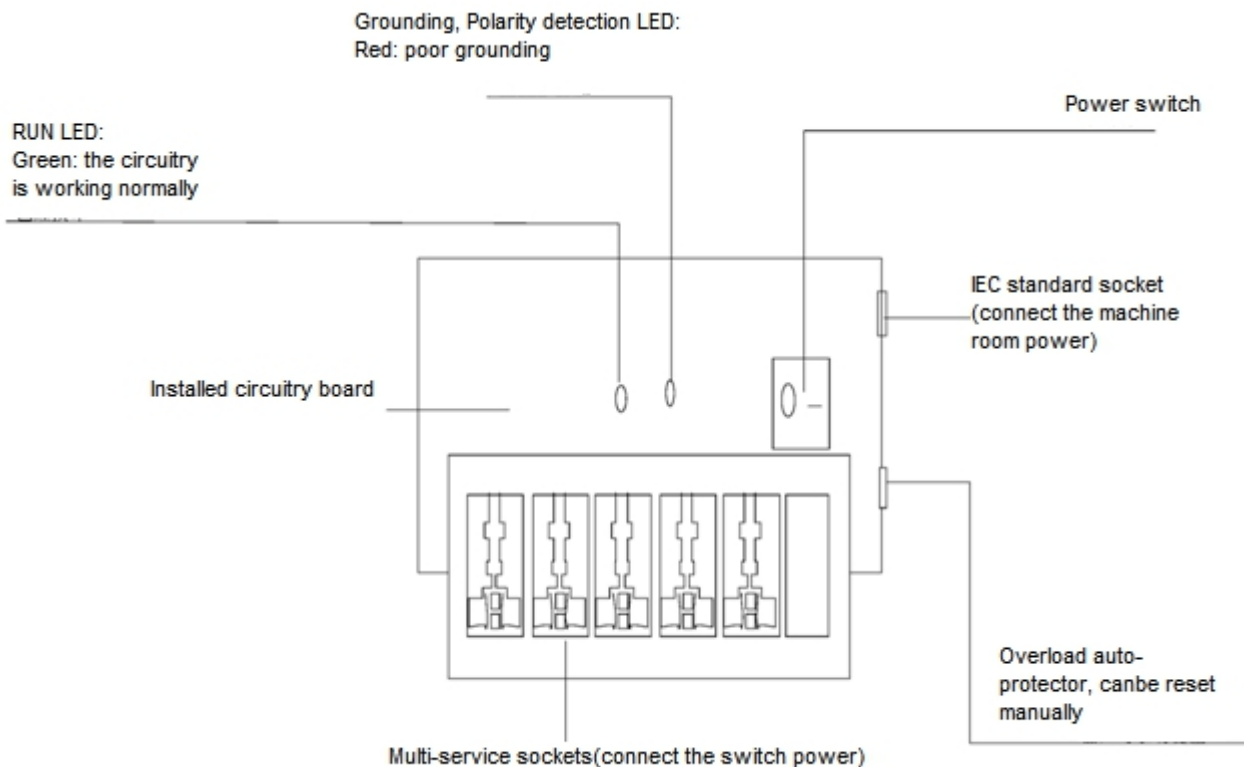

**i** The power arrester is not provided and the user shall purchase it to address the practical requirement.

Precautions for installation:

- Make sure that the PE terminal of the power arrester has been well-grounded;
- After connecting the switch AC power plug to the socket of the power arrester (lightning protection cable row), lightning protection function implements if the RUN LED is Green and the ALARM LED is OFF.
- If the ALARM LED on the power arrester is Red, you shall check what the reason is, poor grounding connection or the reversed connection of the Null and Live lines: Use the multimeter to check the polarity of the power socket for the arrester when the LED is Red, if the N line is on the left and the L line is on the right, the arrester PE terminal is not grounded; if the L line is on the left and the N line is on the right, the polarity of the arrester power cable shall be reversed; if the LED is still Red, it is confirmed that the arrester PE terminal has not been grounded.

### Installing the Ethernet Port Arrester

During the switch usage, the Ethernet port arrester shall be connected to the switch to prevent the switch damage by lightning before the outdoor network cable connects to the switch.

Tools: Cross or straight screwdriver, Multimeter, Diagonal pliers

Installation Steps:

1. Tear one side of the protection paper for the double-sided adhesive tape and paste the tape to the framework of the Ethernet port arrester. Tear the other side of the protection paper for the double-sided adhesive tape and paste the Ethernet port arrester to the switch framework. The paste location for the Ethernet port arrester shall be as close to the grounding terminal of the switch.

Based on the distance of the switch grounding terminal, cut the grounding line for the Ethernet port arrester and firmly tighten the grounding line to the grounding terminal of the switch.

Use the multimeter to check whether the grounding line for the arrester is in good contact with the switch grounding terminal and the framework.

According to the description on the Ethernet Port Arrester Hardware Installation Guide, connect the arrester using the adapter cable (note that the external network cable is connected to the end of IN, while the adapter cable connected to the switch is connected to the end of OUT) and observe whether the LED on the board is normal or not.

Use the nylon button to bundle the power cables.

Figure C-2 Schematic Diagram for the Ethernet port Arrester Installation

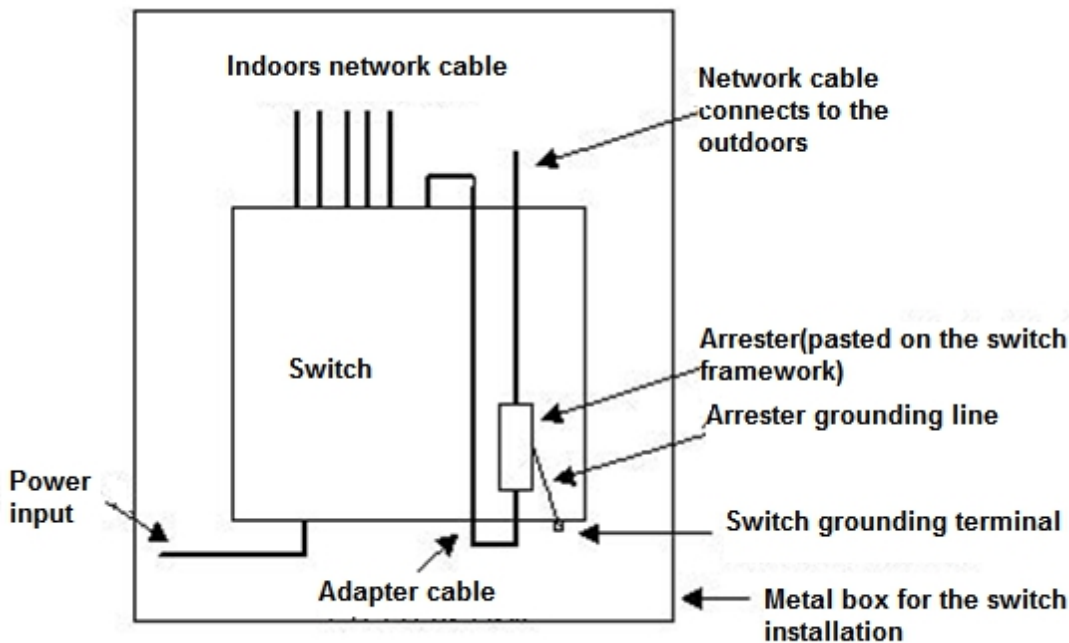

- i** The Ethernet port arrester is only for the 10M/100M copper Ethernet ports with the RJ-45 connector;
- i** The Ethernet port arrester is not provided, the user can purchase them to address their own practical requirements. For the detailed information during the arrester installation, please refer to Ethernet Port Arrester Hardware Installation Guide, which contains the technical specification and the maintenance and installation of the arrester.

You may pay attention to the following conditions during the actual installation to avoid influencing the performance of the Ethernet port arrester:



- Reversed direction of the arrester installation. You shall connect the external network cable to the “IN” end and connect the switch Ethernet port to the “OUT” end.
- Poor arrester grounding. The length of the grounding line should be as short as possible to ensure that it is in good contact with the switch grounding terminal. Use the multimeter to confirm the contact condition after the grounding.
- Incomplete arrester installation. If there is more than one port connected to the peer device on the switch, it needs to install the arresters on all connection ports for the purpose of the lightning protection.

## Appendix D: Cabling Recommendations in Installation

When RG-S1920 series switches are installed in standard 19-inch cabinets, the cables are tied in the binding rack on the cabinet by the cabling rack, and top cabling or bottom cabling is adopted according to the actual situation in the equipment room. All cable connectors should be placed at the bottom of the cabinet in an orderly manner instead of outside the cabinet easy to touch. Power cables are routed beside the cabinet, and top cabling or bottom cabling is adopted according to the actual situation in the equipment room, such as the position of the DC power distribution box, AC socket, or lightning protection box.

### Requirement for the minimum cable bend radius

- The bend radius of a power cord, communication cable, and flat cable should be greater than five times their respective diameters. The bend radius of these cables that often bend or suffer removal/insertion should be greater than seven times their respective diameters.
- The bend radius of a common coaxial cable should be greater than seven times its diameter. The bend radius of this type of cables that often bend or suffer removal/insertion should be greater than 10 times its diameter.
- The bend radius of a high-speed cable (SFP cable, for example) should be greater than five times its diameter. The bend radius of this type of cables that often bend or suffer removal/insertion should be greater than 10 times its diameter.

### Requirement for the minimum fiber bend radius

- The diameter of a fiber tray to hold fibers cannot be less than 25 times the diameter of the fiber.
- When moving an optical fiber, the bend radius of the fiber should be equal to or greater than 20 times the diameter of the fiber.
- During cabling of an optical fiber, the bend radius of the fiber should be equal to or greater than 10 times the diameter of the fiber.

### Precautions for Bundling up Cables

- Before bundling cables, correctly mark labels and stick the labels to cables where appropriate.
- Cables should be neatly and properly bundled, as shown in Figure D-1.

Figure D-1 Bundling Up Cables (1)

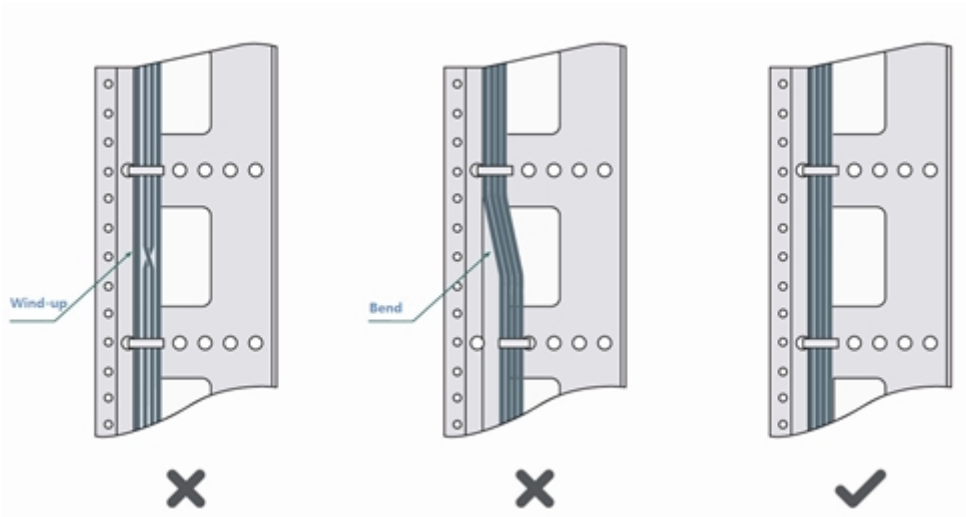

- Cables of different types (such as power cords, signal cables, and grounding cables) should be separated in cabling and bundling. When they are close, crossover cabling can be adopted. In the case of parallel cabling, power cords and signal cables should maintain a space equal to or greater than 30 mm.
- The binding rack and cabling slot inside and outside the cabinet should be smooth, without sharp corners.
- The metal hole traversed by cables should have a smooth and fully rounding surface or an insulated lining.
- Proper buckles should be selected to bundle up cables. It is forbidden to connect two or more buckles to bundle up cables.
- After bundling up cables with buckles, you should cut off the remaining part. The cut should be smooth and trim, without sharp corners, as shown in Figure D-2.

Figure D-2 Bundling Up Cables (2)

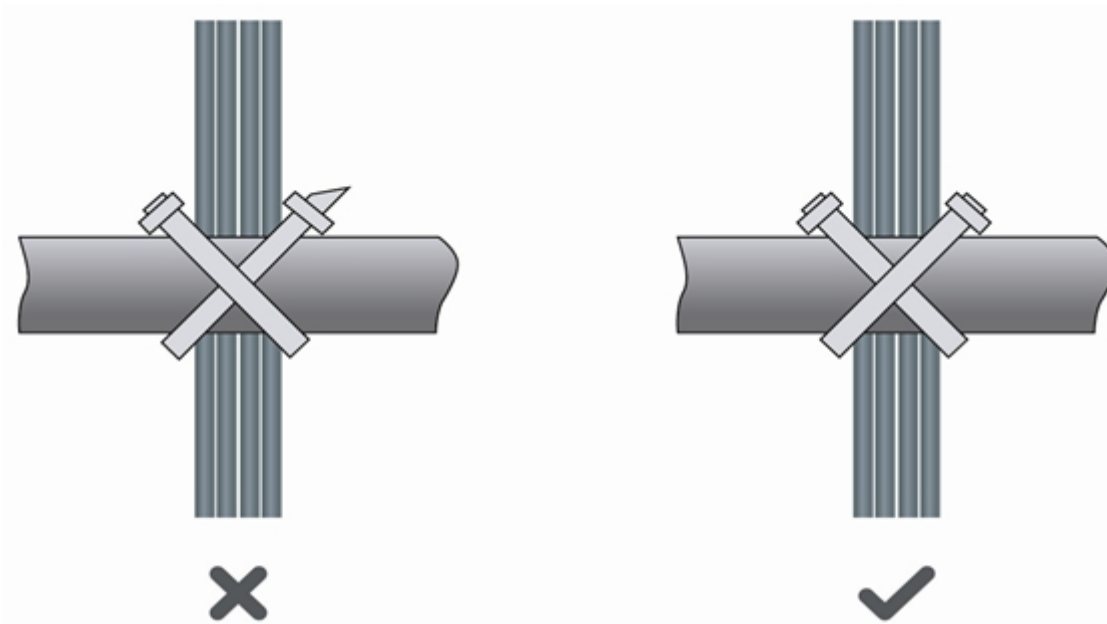

- When cables need to bend, you should first bundle them up. However, the buckle cannot be bundled within the bend area. Otherwise, significant stress may be generated in cables, breaking cable cores. As shown in Figure D-3.

Figure D-3 Bundling Up Cables (3)

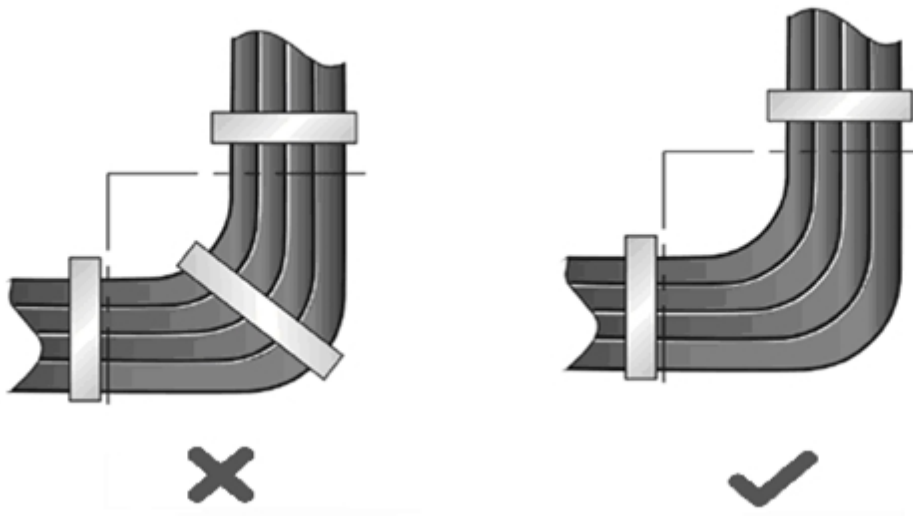

- Cables not to be assembled or remaining parts of cables should be folded and placed in a proper position of the cabinet or cabling slot. The proper position indicates a position that will not affect device running or cause device damage or cable damage during commissioning.
- The power cords cannot be bundled on the guide rails of moving parts.
- The power cables connecting moving parts such as door grounding wires should be reserved with some access after assembled. When the moving part reaches the installation position, the remaining part should not touch heat sources, sharp corners, or sharp edges. If heat sources cannot be avoided, high-temperature cables should be used.
- When using screw threads to fasten cable terminals, the bolt or screw must be tightly fastened, and anti-loosening measures should be taken, as shown in Figure D-4.

Figure D-4 Cable Fastening

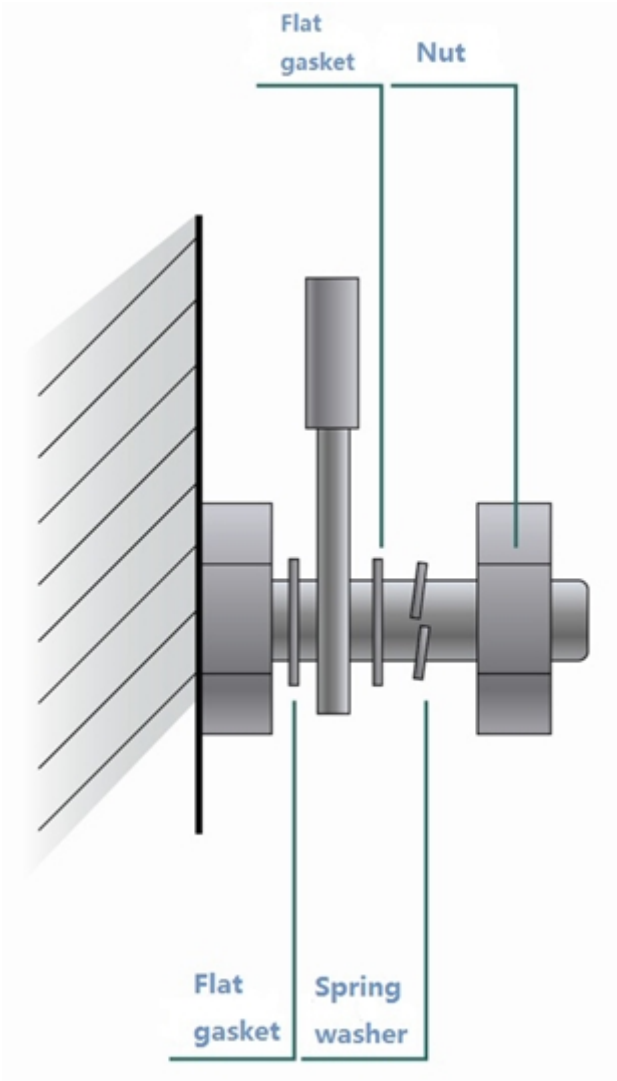

- The hard power cable should be fastened by the terminal connection area to prevent stress.
- Do not use self-tapping screws to fasten terminals.
- Power cables of the same type and in the same cabling direction should be bundled up into cable bunches, with cables in cable bunches clean and straight.
- Binding by using buckles should be performed according to Table D-1.

Cable Bunch Diameter (mm)	Binding Space (mm)
10	80-150
10-30	150-200
30	200-300

- No knot is allowed in cabling or bundling.
- For solder-less terminal blocks (such as air switches) of the cold pressing terminal type, the metal part of the cold pressing terminal should not be exposed outside the terminal block when assembled

## Appendix E: Site Selection

- The machine room should be at least 5km away from the heavy pollution source such as the smelter, coal mine and thermal power plant, 3.7km away from the medium pollution source such as the chemical industry, rubber industry and electroplating industry, and 2km away from the light pollution source such as the food manufacturer and leather plant. If the pollution source is unavoidable, the machine room should be located on the windward side of the pollution source perennially with advanced protection.
- The machine room should be at least 3.7km away from the sea or salt lake. Otherwise, the machine room must be sealed, with air conditioner installed for temperature control. Saline soil cannot be used for construction. Otherwise, you should select devices with advanced protection against severe environment.
- Do not build the machine room in the proximity of livestock farms. Otherwise, the machine room should be located on the windward side of the pollution source perennially. The previous livestock house or fertilizer warehouse cannot be used as the machine room.
- The machine room should be firm enough to withstand severe weather conditions such as windstorm and heavy rain as well as away from dust. If the dust is unavoidable, keep the door and window away from the pollution source.
- The machine room should be away from the residential area. Otherwise, the machine room should meet the construction standard in terms of noise.
- Make sure the air vent of the machine room is away from the sewage pipe, septic tank, and sewage treatment tank. Keep the machine room under positive pressure to prevent corrosive gas from entering the machine room to corrode components and circuit boards. Keep the machine room away from industrial boiler and heating boiler.
- The machine room had better be on the second floor or above. Otherwise, the machine room floor should be 600mm higher than the highest flood level ever recorded.
- Make sure there are no cracks or holes in the wall and floor. If there are cable entries in the wall or window, take proper sealing measures. Ensure that the wall is flat, wear-resistant, and dust-free, which should be up to the standard for flame retarding, soundproofing, heat absorption, dust reduction, and electromagnetic shielding.
- Keep the door and the window closed to make the machine room sealed.
- The steel door is recommended for soundproofing.
- Sulfur-containing materials are forbidden.
- Pay attention to the location of the air conditioner. Keep the air conditioner from blowing wind straight toward the device or blowing water drops from the window or air vent toward the device.