



Ruijie RG-IS2700G Series Switches

Hardware Installation and Reference Guide V1.15

Copyright Statement

Ruijie Networks©2020

Ruijie Networks reserves all copyrights of this document. Any reproduction, excerption, backup, modification, transmission, translation or commercial use of this document or any portion of this document, in any form or by any means, without the prior written consent of Ruijie Networks is prohibited.

Exemption Statement

This document is provided “as is”. The contents of this document are subject to change without any notice. Please obtain the latest information through the Ruijie Networks website. Ruijie Networks endeavors to ensure content accuracy and will not shoulder any responsibility for losses and damages caused due to content omissions, inaccuracies or errors.

Preface

Thank you for using our products. This manual will guide you through the installation of the device.

This manual describes the functional and physical features and provides the device installation steps, hardware troubleshooting, module technical specifications, and specifications and usage guidelines for cables and connectors.

Audience

It is intended for the users who have some experience in installing and maintaining network hardware. At the same time, it is assumed that the users are already familiar with the related terms and concepts.

Obtaining Technical Assistance

- Ruijie Networks Website: <https://www.ruijienetworks.com/>
- Technical Support Website: <https://ruijienetworks.com/support>
- Case Portal: <https://caseportal.ruijienetworks.com>
- Community: <https://community.ruijienetworks.com>
- Technical Support Email: service_rj@ruijienetworks.com
- Skype: [service_rj@ruijienetworks.com](https://www.skype.com/people/service_rj@ruijienetworks.com)

Related Documents

Documents	Description
Configuration Guide	Describes network protocols and related mechanisms that supported by the product, with configuration examples.
Command Reference	Describes the related configuration commands, including command modes, parameter descriptions, usage guides, and related examples.

Symbol Conventions



Means reader take note. Notes contain helpful suggestions or references.



Means reader be careful. In this situation, you might do something that could result in equipment damage or loss of data.

1 Product Overview

The RG-IS2700G series switches are the next generation layer-2 switches launched by Ruijie Networks. Integrated with high performance, high security and multiple services, the RG-IS2700G series switches are mainly deployed in the scenario of outdoor weak batter cases or on the wall with the DIN rail mounted to provide full line-rate layer-2 switching and complete QoS policies, and to ensure the undelayed transmission of key data by applying different traffic classification rules to different applications. RG-IS2700G is shipped with brackets for wall mounting.

Table 1-1 RG-IS2700G series

Model	10/100/1000Base-T adaptive Ethernet port	1000Base-X SFP port	Console port
RG-IS2712G	8	4	1
RG-IS2706G	4	2	1

1.1 RG-IS2712G

Technical Specifications

Table 1-2 Technical specifications of the RG-IS2712G Switches

Model	RG-IS2712G
Module Type	<ul style="list-style-type: none"> ● Gigabit Ethernet: <ul style="list-style-type: none"> MINI-GBIC-SX-MM850 MINI-GBIC-LX-SM1310 MINI-GBIC-LH40-SM1310 MINI-GBIC-ZX50-SM1550 MINI-GBIC-ZX80-SM1550 MINI-GBIC-ZX100-SM1550 GE-SFP-LX20-SM1310-BIDI GE-SFP-LX20-SM1550-BIDI GE-SFP-LH40-SM1310-BIDI GE-SFP-LH40-SM1550-BIDI ● 1000Base-T: <ul style="list-style-type: none"> Mini-GBIC-GT SFP module, supporting 2.5Gbps bandwidth and VSU deployment: GE-SFP-STACK1.6M <p>i The supported module type may change at any time. Contact us for the detailed change information.</p> <p>i BIDI optic modules must be used in pairs. If GE-SFP-LX20-SM1310-BIDI is used at one end, then GE-SFP-LX20-SM1550-BIDI must be applied to the other end. Please refer to AppendixB for BIDI optic module details.</p>

SFP Port	Supporting 1000Base-X; Supporting 2.5Gbps bandwidth, and VSU deployment
Power Supply	<ul style="list-style-type: none"> ● AC input: Rated voltage range: 100VAC to 240VAC Maximum voltage range: 85VAC to 265VAC Frequency: 50Hz to 60Hz Rated current: 0.4A Earth leakage current: ≤2.0mA ● HVDC input: Rated voltage range: 140VDC to 340VDC Maximum voltage range: 130VDC to 370VDC Rated current: 0.4A
Power Consumption	Max.12 W
Operating Temperature	-40°C to 85°C (-40°F to 185°F)
Storage Temperature	-40°C to 85°C (-40°F to 185°F)
Operating Humidity	10% to 90% RH (non condensing)
Storage Humidity	10% to 90% RH (non condensing)
Fan	Fanless
Temperature Warning	Support
Alarm Port	Support alarm through the pin terminal.
IP Rating	IP40
EMI	GB 9254-2008,FCC Part 15, CISPR (EN55022) class A,
EMS	IEC/EN 61000-4-2 ESD Contact Discharge: 8 kV Air Discharge: 15 kV
	IEC/EN 61000-4-3 RS 80-1,000 MHz 10V/m 1,400-2,000 MHz 3V/m 2,000-2,700 MHz 1V/m
	IEC/EN 61000-4-4 EFT Power cable 2 kV Data cable 1 kV
	IEC/EN 61000-4-6 CS 15kHz-80 MHz 10V
	IEC/EN 61000-4-8 PFMF 50Hz 30A/m
	IEC/EN 61000-4-5 Surge Power cable, L/N 2kV Power cable, L-PE/N-PE 6kV Data cable 6kV
	IEC/EN 61000-4-11 DIP AC220V CLASS 3 AC110V CLASS 3

Security Compliance	GB4943-2001
Dimensions (W x D x H)	160 mm x 115 mm x 52 mm
Weight	1 kg

i RG-IS2712G switch is a class A product. In a domestic environment, this product may cause radio interference in which case the user may be required to take adequate measures.

Product Appearance

The front panel of the RG-IS2712G Ethernet switch provides eight 10/100/1000Base-T Ethernet ports, four Gigabit SFP fiber ports and one Console port. The back panel provides AC power input ports. Figure 1-1 shows the appearance of the RG-IS2712G.

Figure 1-1 Appearance of the RG-IS2712G



Front Panel

Figure 1-2 RG-IS2712G Front Panel

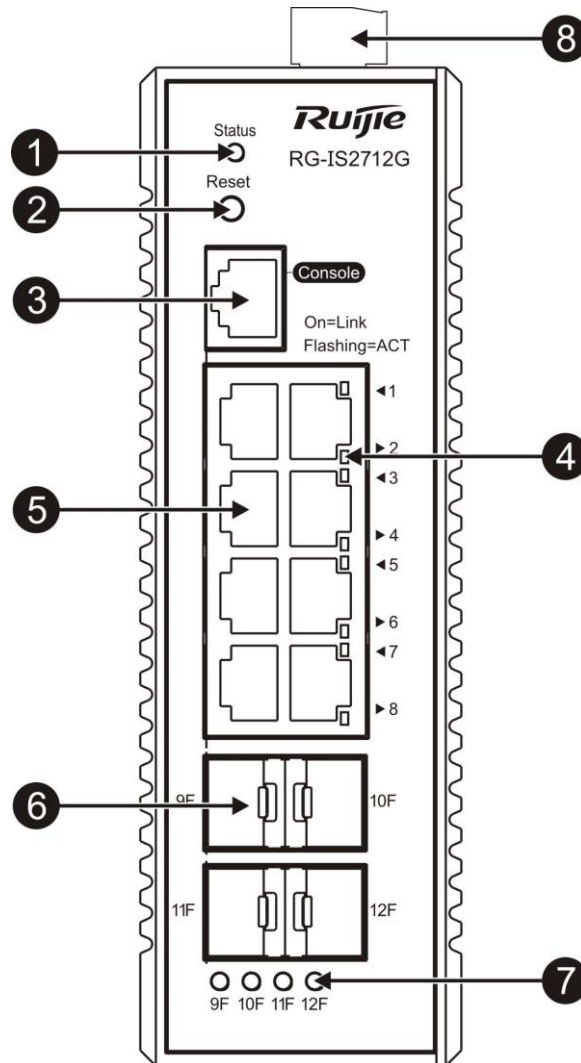

Note	1. Switch status indicator	5. 10/100/1000Base-T adaptive Ethernet port
	2. Reset button	6. 1000Base-X SFP port/2.5 G stack port
	3. Console port	7. 1000Base-X SFP port indicator
	4. 10/100/1000Base-T adaptive Ethernet port indicator	8. Pin terminal (Power port and alarm port)

Side panel

Figure 1-3 RG-IS2712G Side Panel



Note 1. 6-pin AC power connector (**PWR** indicates the AC power port, and **Fault** indicates the alarm port) 2. Grounding pole 3. Warning Label for high temperature and electric shock

Back panel

Figure 1-4 RG-IS2712G Back Panel

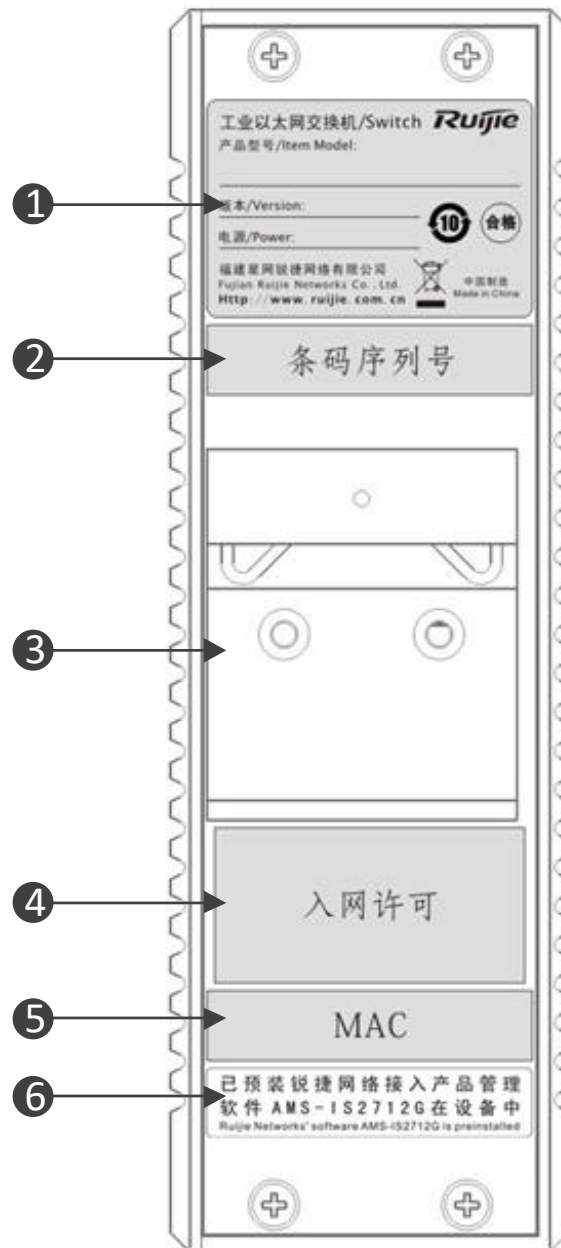

Note

- | | |
|------------------------------|---|
| 1. Product information label | 4. Network access license of the device |
| 2. Device bar code | 5. MAC address of the device |
| 3. DIN slot | 6. Tips for software preinstallation |

Power Supply

The RG-IS2712G switch adopts the AC power input.

- AC input:

Rated voltage range: 100 VAC to 240 VAC

Maximum voltage range: 85 VAC to 265 VAC

Frequency: 50 Hz to 60 Hz

Rated current: 0.4 A

Power cord specification: 10 A power cord

Heat Dissipation

The RG-IS2712G switch is designed with no fans. To ensure good dissipation, sufficient ventilation space (10 cm distance from both sides and the back panel of the chassis) should be reserved to avoid the air inlet of the chassis from being blocked; otherwise, the dissipation might be affected.

LED Indicators



Indicator	Faceplate Marker	Status	Meaning
Status indicator	Status	Off	The switch is not powered on.
		Blinking green	The switch is being initialized. If the blinking persists, however, it indicates that an abnormality occurs.
		Solid green	The switch is operational.
		Solid yellow	It indicates a warning on the switch temperature. Check the working environment of the switch immediately.
		Solid red	Indicates a fault on the switch. For details, refer to Section of Troubleshooting Common Faults .
RJ-45 port indicator	1~8	Off	No link, or port was administratively shut down.
		Solid green	Link present.
		Blinking green	Activity. The port is receiving or sending data.
SFP port indicator	9F-12F	Off	No link, or port was administratively shut down.
		Solid green	Link present.
		Blinking green	Activity. The port is receiving or sending data.

1.2 RG-IS2706G

Technical specifications

Table 1-3 Technical specifications of the RG-IS2706G Switches

Model	RG-IS2706G
--------------	------------

Module Type	<ul style="list-style-type: none"> ● Gigabit Ethernet: MINI-GBIC-SX-MM850 MINI-GBIC-LX-SM1310 MINI-GBIC-LH40-SM1310 MINI-GBIC-ZX50-SM1550 MINI-GBIC-ZX80-SM1550 MINI-GBIC-ZX100-SM1550 GE-SFP-LX20-SM1310-BIDI GE-SFP-LX20-SM1550-BIDI GE-SFP-LH40-SM1310-BIDI GE-SFP-LH40-SM1550-BIDI ● 1000Base-T: Mini-GBIC-GT ● SFP module, supporting 2.5Gbps bandwidth and VSU deployment: GE-SFP-STACK1.6M <hr/> <p> The supported module type may change at any time. Contact us for the detailed change information.</p> <p> BIDI optic modules must be used in pairs. If GE-SFP-LX20-SM1310-BIDI is used at one end, then GE-SFP-LX20-SM1550-BIDI must be applied to the other end. Please refer to AppendixB for BIDI optic module details.</p>
SFP Port	Supporting 1000Base-X; Supporting 2.5Gbps bandwidth, and VSU deployment
Power Supply	<ul style="list-style-type: none"> ● AC input: Rated voltage range: 100VAC to 240VAC Maximum voltage range: 85VAC to 265VAC Frequency: 50Hz to 60Hz Rated current: 0.4A Earth leakage current: ≤2.0mA ● HVDC input: Rated voltage range: 140VDC to 340VDC Maximum voltage range: 130VDC to 370VDC Rated current: 0.4A
Power Consumption	Max. 9W (Including two 1.5W optical modules)
Operating Temperature	-40°C to 85°C (-40°F to 185°F)
Storage Temperature	-40°C to 85°C (-40°F to 185°F)
Operating Humidity	5% to 95% RH (non condensing)
Storage Humidity	5% to 95% RH (non condensing)
Fan	Fanless
Temperature Warning	Support
Alarm Port	Support alarm through the pin terminal.

IP Rating	IP40
EMI	GB 9254-2008,FCC Part 15, CISPR (EN55022) class A,
EMC	IEC/EN 61000-4-2 ESD Contact Discharge 8 kV Air Discharge 15 kV
	IEC/EN 61000-4-3 RS 80-1,000 MHz 10V/m 1,400-2,000 MHz 3V/m 2,000-2,700 MHz 1V/m
	IEC/EN 61000-4-4 EFT Power Cable 2 kV Data Cable 1 kV
	IEC/EN 61000-4-6 CS 15kHz-80 MHz 10V
	IEC/EN 61000-4-8 PFMF 50Hz 30A/m
	IEC/EN 61000-4-5 Surge Power cable, L/N 2kV Power cable, L-PE/N-PE 6kV Data cable 6kV
	IEC/EN 61000-4-11 DIP AC220V CLASS 3 AC110V CLASS 3
Security Compliance	GB4943-2011
Dimensions (W x D x H)	160 mm x 115 mm x 52 mm
Weight	1kg

 RG-IS2706G switch is a class A product. In a domestic environment, this product may cause radio interference in which case the user may be required to take adequate measures.

Product Appearance

The front panel of the RG-IS2706G Ethernet switch provides four 10/100/1000Base-T Ethernet ports, two Gigabit SFP fiber ports and one Console port. The back panel provides AC power input ports. Figure 1-4 shows the appearance of the RG-IS2706G.

Figure 1-5 Appearance of the RG-IS2706G



Front Panel

Figure 1-6 RG-IS2706G Front Panel

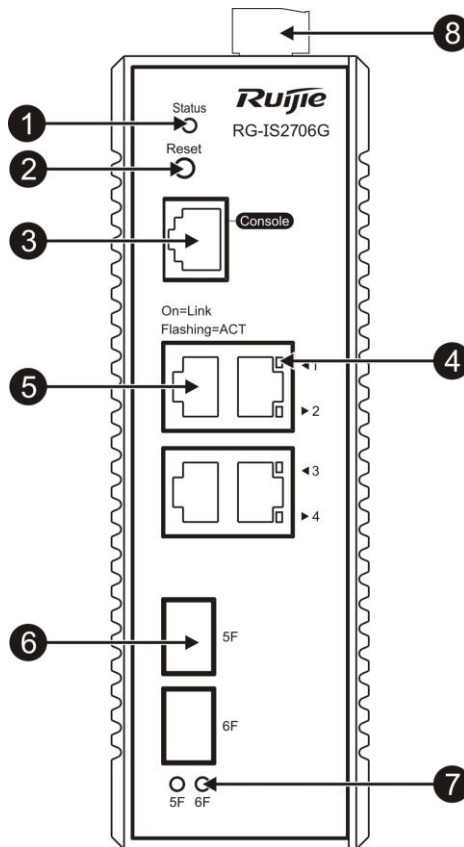

Note	1. Switch status indicator	5. 10/100/1000Base-T adaptive Ethernet port
	2. Reset button	6. 1000Base-X SFP port/2.5 G stack port
	3. Console port	7. 1000Base-X SFP port indicator
	4. 10/100/1000Base-T adaptive Ethernet port indicator	8. Pin terminal (Power port and alarm port)

Side panel

Figure 1-7 RG-IS2706G Side Panel



Note	1. 6-pin AC power connector (PWR indicates the AC power port, and Fault indicates the alarm port)	2. Grounding pole 3. Warning Label for high temperature and electric shock
-------------	--	---

Back panel

Figure 1-8 RG-IS2706G Back Panel

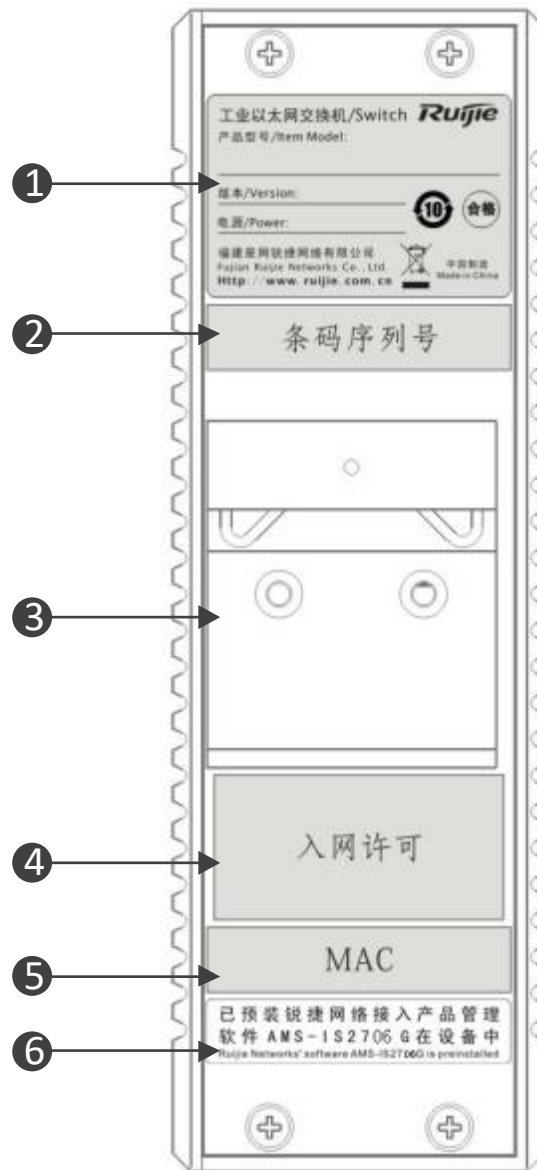

Note	7.	Product information label	10.	Network access license of the device
	8.	Device bar code	11.	MAC address of the device
	9.	DIN slot	12.	Tips for software preinstallation

Power Supply

The RG-IS2706G adopts the AC power input.

- AC input:

Rated voltage range: 100VAC to 240VAC

Maximum voltage range: 90VAC to 264VAC

Frequency: 50Hz to 60Hz

Rated current: 0.5A

Power cord specification: 10A power cord

Heat Dissipation

The RG-IS2706G is designed with no fans. To ensure good dissipation, sufficient ventilation space (10cm distance from both sides and the back panel of the chassis) should be reserved to avoid the air inlet of the chassis being blocked; otherwise, the dissipation might be affected.

LED Indicators



Indicator	Faceplate Marker	Status	Meaning
Status indicator	Status	Off	The switch is not powered on.
		Blinking green	The switch is being initialized. If the blinking persists, however, it indicates that an abnormality occurs.
		Solid green	The switch is operational.
		Solid yellow	It indicates a warning on the switch temperature. Check the working environment of the switch immediately.
		Solid red	Indicates a fault on the switch. For details, refer to Section of Troubleshooting Common Faults .
RJ-45 port indicator	1~4	Off	No link, or port was administratively shut down.
		Solid green	Link present.
		Blinking green	Activity. The port is receiving or sending data.
SFP port indicator	5F, 6F	Off	No link, or port was administratively shut down.
		Solid green	Link present.
		Blinking green	Activity. The port is receiving or sending data.

1.3 RG-IS2712G-DC

Technical Specifications

Table 1-4 Technical specifications of the RG-IS2712G-DC Switches

Model	RG-IS2712G-DC

Module Type	<ul style="list-style-type: none"> ● Gigabit Ethernet: MINI-GBIC-SX-MM850 MINI-GBIC-LX-SM1310 MINI-GBIC-LH40-SM1310 MINI-GBIC-ZX50-SM1550 MINI-GBIC-ZX80-SM1550 MINI-GBIC-ZX100-SM1550 GE-SFP-LX20-SM1310-BIDI GE-SFP-LX20-SM1550-BIDI GE-SFP-LH40-SM1310-BIDI GE-SFP-LH40-SM1550-BIDI ● 1000Base-T: Mini-GBIC-GT ● SFP module, supporting 2.5Gbps bandwidth and VSU deployment: GE-SFP-STACK1.6M <p> The supported module type may change at any time. Contact us for the detailed change information.</p> <p> BIDI optic modules must be used in pairs. If GE-SFP-LX20-SM1310-BIDI is used at one end, then GE-SFP-LX20-SM1550-BIDI must be applied to the other end. Please refer to AppendixB for BIDI optic module details.</p>
SFP Port	Supporting 1000Base-X; Supporting 2.5Gbps bandwidth, and VSU deployment
Power Supply	<ul style="list-style-type: none"> ● DC input: Rated voltage: 24VDC, 48VDC Maximum voltage range: 18VDC to 72VDC Maximum current: 1.0A <p>Two power supplies are supported for 1+1 power redundancy.</p>
Power Consumption	Max.12 W
Operating Temperature	-40°C to 85°C
Storage Temperature	-40°C to 85°C
Operating Humidity	10% to 90% RH (non condensing)
Storage Humidity	10% to 90% RH (non condensing)
Fan	Fanless
Temperature Warning	Support
Alarm Port	Support alarm through the pin terminal.
IP Rating	IP40
EMI	GB 9254-2008,FCC Part 15, CISPR (EN55022) class A,
EMS	IEC/EN 61000-4-2 ESD Contact Discharge: 8 kV

	Air Discharge: 15 kV
	IEC/EN 61000-4-3 RS
	80-1,000 MHz 10V/m
	1,400-2,000 MHz 3V/m
	2,000-2,700 MHz 1V/m
	IEC/EN 61000-4-4 EFT
	Power cable 2 kV
	Data cable 1 kV
IEC/EN 61000-4-6 CS	
15kHz-80 MHz 10V	
IEC/EN 61000-4-8 PFMF	
50Hz 30A/m	
IEC/EN 61000-4-5 Surge	
Power cable, L/N 2kV	
Power cable, L-PE/N-PE 6kV	
Data cable 6kV	
Security Compliance	GB4943-2001
Dimensions (W x D x H)	160 mm x 115 mm x 52 mm
Weight	1 kg

i RG-IS2712G-DC switch is a class A product. In a domestic environment, this product may cause radio interference in which case the user may be required to take adequate measures.

Product Appearance

The front panel of the RG-IS2712G-DC Ethernet switch provides eight 10/100/1000Base-T Ethernet ports, four Gigabit SFP fiber ports and one Console port. The back panel provides AC power input ports. Figure 1-1 shows the appearance of the RG-IS2712G-DC.

Figure 1-9 Appearance of the RG-IS2712G-DC



Front Panel

Figure 1-10 RG-IS2712G-DC Front Panel

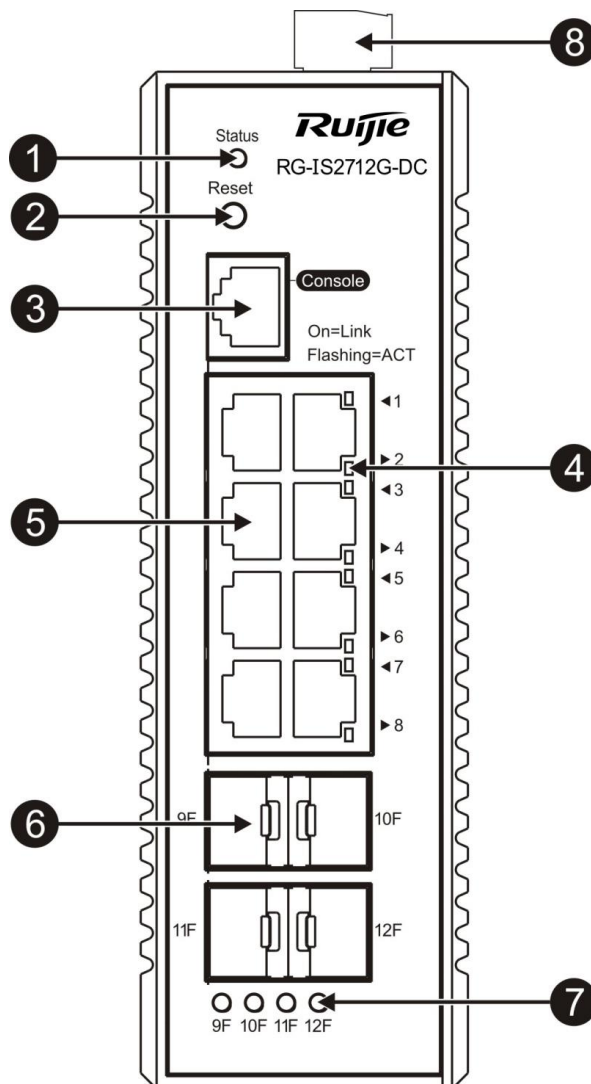

Note

1. Switch status indicator
2. Reset button
3. Console port
4. 10/100/1000Base-T adaptive Ethernet port indicator
5. 10/100/1000Base-T adaptive Ethernet port
6. 1000Base-X SFP port/2.5 G stack port
7. 1000Base-X SFP port indicator
8. Pin terminal (Power port and alarm port)

Side panel

Figure 1-11 RG-IS2712G-DC Side Panel

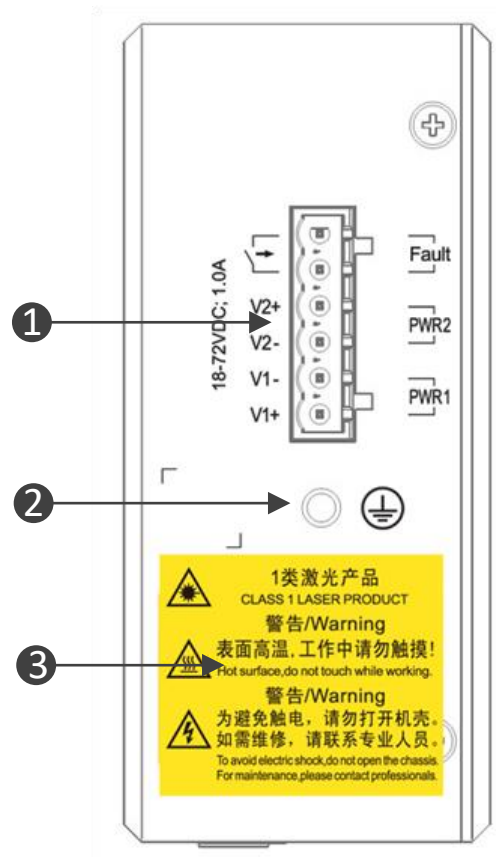

Note	1. Six-pin power connector (PWR	2. Grounding pole
	indicates the AC power port, and Fault	3. Warning Label for high temperature and electric shock
	indicates the alarm port)	

Back panel

Figure 1-12 RG-IS2712G-DC Back Panel

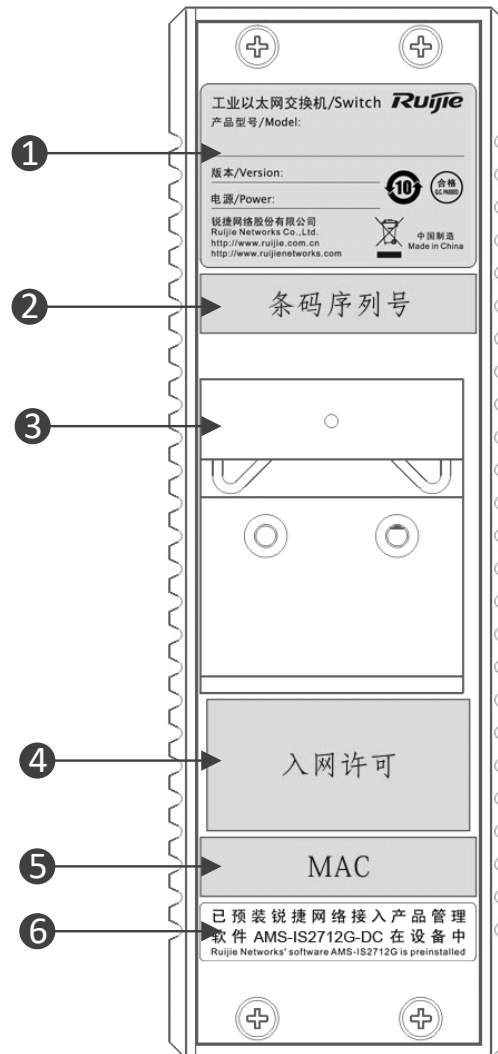

Note	1.	Product information label	4.	Network access license of the device
	2.	Device bar code	5.	MAC address of the device
	3.	DIN slot	6.	Tips for software preinstallation

Power Supply

The RG-IS2712G-DC switch adopts the DC power input. Two power supplies are supported for 1+1 power redundancy.

- DC input:

Rated voltage: 24VDC, 48VDC

Maximum voltage range: 18VDC to 72VDC

Maximum current: 0.1A

Heat Dissipation



The RG-IS2712G-DC switch is designed with no fans. To ensure good dissipation, sufficient ventilation space (10 cm distances from both sides and the back panel of the chassis) should be reserved to avoid the air inlet of the chassis from being blocked; otherwise, the dissipation might be affected.

LED Indicators

Indicator	Faceplate Marker	Status	Meaning
Status indicator	Status	Off	The switch is not powered on.
		Blinking green	The switch is being initialized. If the blinking persists, however, it indicates that an abnormality occurs.
		Solid green	The switch is operational.
		Solid yellow	It indicates a warning on the switch temperature. Check the working environment of the switch immediately.
		Solid red	Indicates a fault on the switch. For details, refer to Section of Troubleshooting Common Faults .
RJ-45 port indicator	1~8	Off	No link, or port was administratively shut down.
		Solid green	Link present.
		Blinking green	Activity. The port is receiving or sending data.
SFP port indicator	9F-12F	Off	No link, or port was administratively shut down.
		Solid green	Link present.
		Blinking green	Activity. The port is receiving or sending data.

2 Preparation before Installation

2.1 Safety Suggestions

-  To avoid personal injury and equipment damage, please carefully read the safety suggestions before you install the RG-IS2700G series.
 -  The following safety suggestions do not cover all possible dangers.
-

2.1.1 Safety Precautions for Installing the System

- Make sure the switch is installed in a weak battery case or other devices with a protection class not less than IP54.
- Security design and evaluation of this switch are implemented below an altitude of 5,000 m. There is no security concern below an altitude of 5,000 m while there may be potential risks above 5,000 m.
- Keep the chassis clean and free from any dust.
- Do not place the equipment in a walking area.
- Do not wear loose clothes or any other things that may be caught by the chassis during installation and maintenance.
- Turn off all power supplies and remove the power sockets and cables before dismantling the cabinet.

2.1.2 Movement Safety





- Do not frequently move the device.
- When moving the device, note the balance and avoid hurting legs and feet or straining the back.
- Before moving the device, turn off all power supplies and dismantle all power modules.

2.1.3 Electric Safety

- Observe local regulations and specifications when performing electric operations. Relevant operators must be qualified.
- Carefully check any potential danger in the working area, such as ungrounded power supply, unreliable grounding of the power supply, and damp/wet ground or floor.
- Find out the location of the emergency power supply switch in the room before installation. First cut off the power supply in the case of an accident.
- Try to avoid maintaining the switch that is powered-on alone.
- Be sure to make a careful check before you shut down the power supply.
- Do not place the equipment in a damp location. Do not let any liquid enter the chassis.

 Any nonstandard and inaccurate electric operation may cause an accident such as fire or electrical shock, thus causing severe even fatal damages to human bodies and equipment.

 Direct or indirect touch through a wet object on high-voltage and mains supply may bring a fatal danger.

-
-  If a power supply system is equipped with a leakage protector (also referred to as "leakage current switch" or "leakage current breaker"), the rated leakage action current of each leakage protector is greater than twice of the theoretical maximum leakage current of all the power supplies in the system. For example, if a system is equipped with ten identical power supplies, the leakage current of each power supply is equal to or less than 2mA, and the leakage current of the system totals 20mA. A leakage protector with 30mA rated action current supports less than eight power supplies (that is, Action current of the leakage protector/2/Maximum leakage current of each power supply = $30/2/2 = 7.5$). In other words, the leakage protector with 30mA rated action current supports no more than seven power supplies. In this case, the ten power supplies in the system require at least two leakage protectors with 30mA rated action current and each leakage protector supports five power supplies.
-  If power supplies in a system differ in models, the rated leakage action current of each leakage protector divided by two is greater than the sum of maximum leakage current of all the power supplies. The rated leakage non-action current of a leakage protector shall be 50% of the leakage action current. Take a leakage protector with 30 mA rated leakage action current as an example. The rated leakage non-action current shall be 15 mA. When the leakage current is below 15 mA, the protector shall not act. Otherwise, misoperation may easily occur due to high sensitivity and thus the leakage protector trips, devices are powered off, and services are interrupted.
-  To guarantee personal safety, the rated leakage action current of each leakage protector in the system must be equal to or less than 30 mA (human body safety current is 30 mA). When twice of the total leakage current of the system is greater than 30 mA, the system must be equipped with two or more leakage protectors.
-  For the leakage current value of each power supply model, see the power supply model parameter table in Chapter 1.
-

2.1.4 Static Discharge Damage Prevention

To prevent damage from static electricity, pay attention to the following:

- Proper grounding of the equipment and floor
- Indoor dust prevention
- Proper humidity conditions

2.1.5 Laser Safety

Among the modules supported by the RG-IS2700G series, a great number of optical modules are Class I laser products. Therefore, pay attention to the following when you use them:

- When a fiber transceiver works, ensure that the port has been connected with an optical fiber or is covered with a dust cap, to keep out dust and avoid burning your eyes.
- Do not stare into any optical port.

 Do not stare into any optical port under any circumstances, as this may cause permanent damage to your eyes.

2.2 Installation Site Requirements

The RG-IS2700G series are mainly applicable to the scenario of outdoor weak battery cases. To ensure the normal working and a prolonged durable life of the equipment, the installation site must meet the following requirements.

2.2.1 Ventilation Requirements

For the RG-IS2700G series, you must ensure that sufficient space(at least 10cm distance from both sides of the cabinet) is reserved at the ventilation openings to ensure the normal ventilation. After various cables have been connected, they should be arranged into bundles or placed on the cabling rack to avoid blocking the air inlets.

2.2.2 Temperature and Humidity Requirements

To ensure the normal operation and prolong the service life of RG-IS2700G, you should keep proper temperature and humidity in the equipment room.

If the equipment room has temperature and humidity that do not meet the requirements for a long time, the equipment may be damaged.

- In an environment with high relative humidity, the insulating material may have bad insulation or even leak electricity. Sometimes the materials may suffer from mechanical performance change and metallic parts may get rusted.
- In an environment with low relative humidity, however, the insulating strip may dry and shrink. Static electricity may occur easily and endanger the circuit on the equipment.
- In an environment with high temperature, the equipment is subject to even greater harm, as its performance may degrade significantly and its useful life may be shortened in the case of long-term exposure that expedites the aging process.

Therefore, the ambient temperature and humidity of the RG-IS2700G must meet the requirements listed in Table 2-1:

Table 2-1 Temperature and humidity requirements of the RG-S2600-RG-IS2700G series

Temperature	Relative Humidity
-40°C-85°C (-40°F to 185°F)	5%-95% (non condensing)



The ambient temperature and humidity are measured at the point that is 1.5 m above the floor and 0.4 m before the equipment when there is no protective plate in front or back of the equipment rack.

2.2.3 Cleanness Requirements

Dust poses the top threat to the running of the equipment. The dust falling on the equipment may be adhered by the static electricity, causing bad contact of the metallic joint. Such electrostatic adherence may occur more easily when the relative humidity is low, not only affecting the use life of the equipment, but also causing communication faults. The following table shows the requirements for the dust content and granularity.

Table 2-2

Maximum diameter (μm)	0.5	1	3	5
Maximum density (Particles/m ³)	1.4 x 10	7 x 10	2.4 x 10	1.3 x 10

Apart from dust, the salt, acid and sulfide in the air must also meet strict requirements; as such poisonous substances may accelerate the corrosion of the metal and the aging of some parts. The harmful gases such as sulfur dioxide, sulfured hydrogen, nitrogen dioxide, and chlorine), whose requirements are listed in Table 2-3.

Table 2-3 Requirements for harmful gases in the equipment room

Gas	Average (mg/m ³)	Maximum (mg/m ³)
-----	------------------------------	------------------------------

Sulfur dioxide	0.2	1.5
Sulfured hydrogen	0.006	0.03
Nitrogen dioxide	0.04	0.15
Ammonia	0.05	0.15
Chlorine	0.01	0.3

2.2.4 EMI

Though the RG-IS2700G series have been equipped with anti-EMI measures, they will still be affected when EMI exceeds a certain limit. During applications, the switch may be subject to external interferences that affect the device through conduction manners such as capacitance coupling, inductive coupling, electromagnetic wave emission, common impedance (including grounding systems), and wires (power cables, signal cables and outgoing transmission cables). For that purpose, note that:

- For the AC power supply system TN, single-phase three-core power socket with protective earthing conductors (PE) should be adopted to effectively filter out interference from the power grid through the filtering circuit.
- The switch should be located at places free from large power radio launch pad, radar launch pad, and high-frequency large-current devices.
- If necessary, electromagnetic shielding should be adopted. For example, use interface cables to shield cables.

2.3 System Grounding Requirements

A good grounding system is the basis for the stable and reliable operation of the RG-IS2700G series. It is the chief condition to prevent lightning stroke and resist interference. Please carefully check the grounding conditions on the installation site according to the grounding requirements, and perform grounding operations properly as required.

 The correct connection of grounding lines guarantees the lightning and interference resistance of switches and must be performed with precision.

2.3.1 Safety Grounding

The equipment using AC power supply must be grounded by using the yellow/green safety grounding cable. Otherwise, when the insulating resistance decreases the power supply and the enclosure in the equipment, electric shock may occur.

2.3.2 Lightning Grounding

The lightning protection system of a facility is an independent system that consists of the lightning rod, downlead conductor and the connector to the grounding system, which usually shares the power reference ground and yellow/green safety cable ground. The lightning discharge ground is for the facility only, irrelevant to the equipment.

2.3.3 EMC Grounding

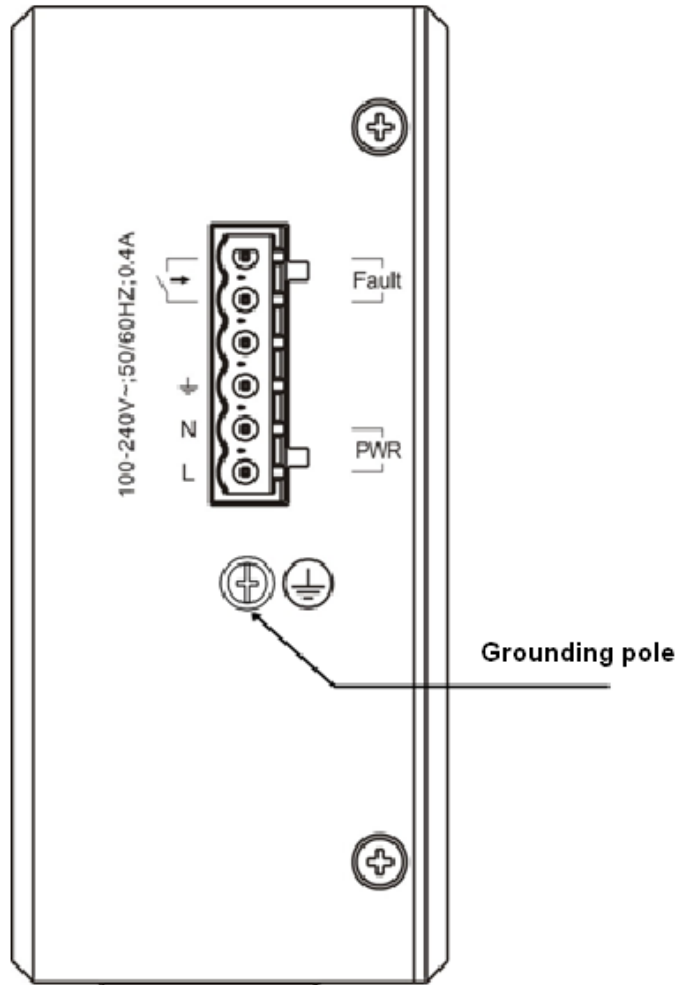

The grounding required for EMC design includes shielding ground, filter ground, noise and interference suppression, and level reference. All the above constitute the comprehensive grounding requirements. The grounding resistance should be less than 1 ohm. The side panel of 0RG-IS2700G is reserved with one grounding pole, as shown in 2-1.

Figure 2-1 RG-IS2700G Grounding



2.4 Lightning Resistance Considerations

When the AC power cable is imported outdoors and directly connected to the power port of the switch, lightning line bank should be adopted to prevent the switch from being hit by lightning shocks. The lightning line bank can be fixed on the cabinet, work station, or the equipment room's wall through line buckles and screws. In applications, the AC first enters the lightning line bank and then the switch.

-
-  The lightning line banks are not provided and should be purchased by users as required.
 -  For the usage of lightning line banks, refer to their related manuals.
-

2.5 EMI Consideration

Various interference sources, from either outside or inside the equipment or application system, affect the system in the conductive ways such as capacitive coupling, inductive coupling, and electromagnetic radiation.

There are two types of electromagnetic interferences: radiated interference and conducted interference, depending on the type of the transmission path.

When the energy, often RF energy, from a component arrives at a sensitive component via the space, the energy is known as radiated interference. The interference source can be either a part of the interfered system or a completely electrically isolated unit. Conducted interference results from the electromagnetic wire or signal cable connection between the source and the sensitive component, along which cable the interference conducts from one unit to another. Conducted interference often affects the power supply of the equipment, but can be controlled by a filter. Radiated interference may affect any signal path in the equipment and is difficult to shield.

- Effective measures should be taken for the power system to prevent the interference from the electric grid.
- The working ground of the switch should be preferably separated and kept as far as possible from the grounding device of the power equipment or the anti-lightning grounding device.
- Keep the equipment away from high-power radio transmitter, radar transmitting station, and high-frequency large-current device.
- Measures must be taken to shield static electricity.

2.6 Precaution for Fiber Connections

Before you connect the fibers, check that the optical connector type and fiber type match the optical interface type used. In addition, pay attention to the Tx and Rx directions of the two-fiber bidirectional optical module. The Tx end of this equipment should be connected to the Rx end of the peer equipment, and the Rx end of this equipment to the Tx end of the peer equipment. The BIDI optical module needs only one-fiber, and uses different wavelengths for bidirectional transmission. Therefore, BIDI modules need to be used in pairs. See Table B-3 in Appendix B for details.

2.7 Installation Tools

- Table 2-4 List of installation tools

Common Tools	Phillips screwdriver, slotted screwdriver, related copper and fiber cables, bolts, diagonal pliers, cable ties
Special Tools	ESD tools
Meter	Multimeter



The listed tools are customer supplied.

3 Product Installation



Please ensure that you have carefully read the Chapter of Preparation before Installation. Make sure that the requirements set forth in Chapter 2 have been met.

3.1 Installation Procedure

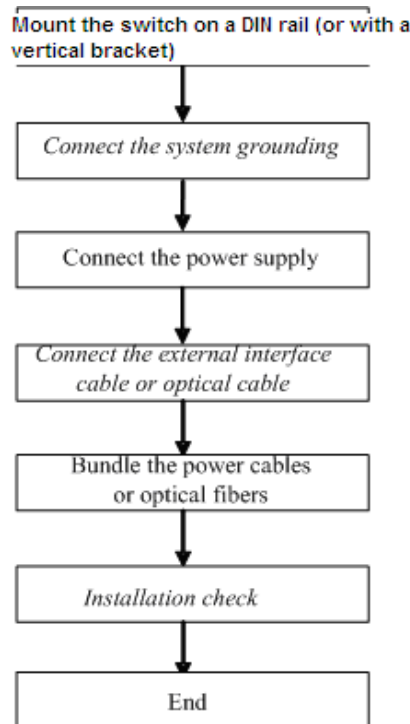

3.2 Confirmations before Installation

Before installation, please confirm the following points:

- Sufficient airflow is available for the switch.
- The Requirements of the switch for temperature and humidity are met.
- Power cables are already laid out and whether the requirements of electrical current are met.
- Related network adaption lines are already laid out.

3.3 Installing the RG-IS2700G Series

3.3.1 Precautions

During installation, note the following points:

- Connect the power cables of different colors to the corresponding grounding posts.

- Ensure that the connected power cables have sound contact.
- Do not place heavy items on the switch.
- Reserve a spacing of at least 10 cm around the chassis for good ventilation. Do not stack the devices.
- The switch should be located at places free from the direct sunlight, large power radio launch pad, radar launch pad, and high-frequency large-current devices. If necessary, electromagnetic shielding should be adopted. For example, use interface cables to shield cables.

3.3.2 Mounting the Switch on a DIN Rail

1. Place the switch on the site where has sufficient space for heat dissipation.
2. Mount the DIN rail to the rail bracket, as shown in the following figures.

Figure 3-1

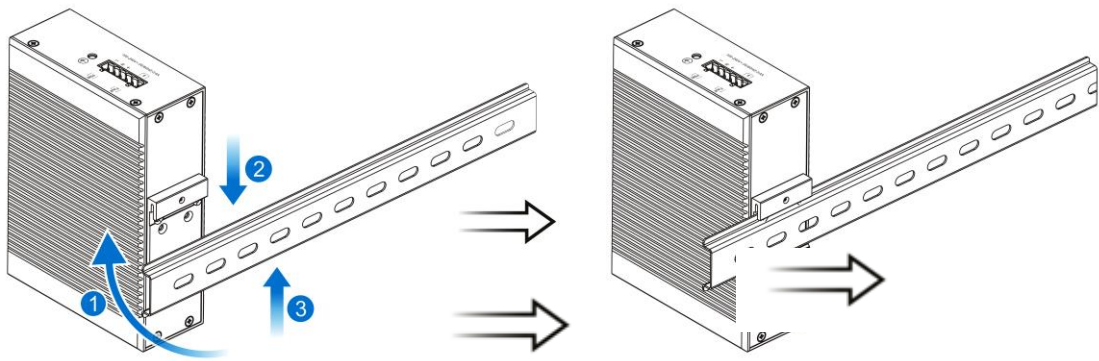

Figure 3-2

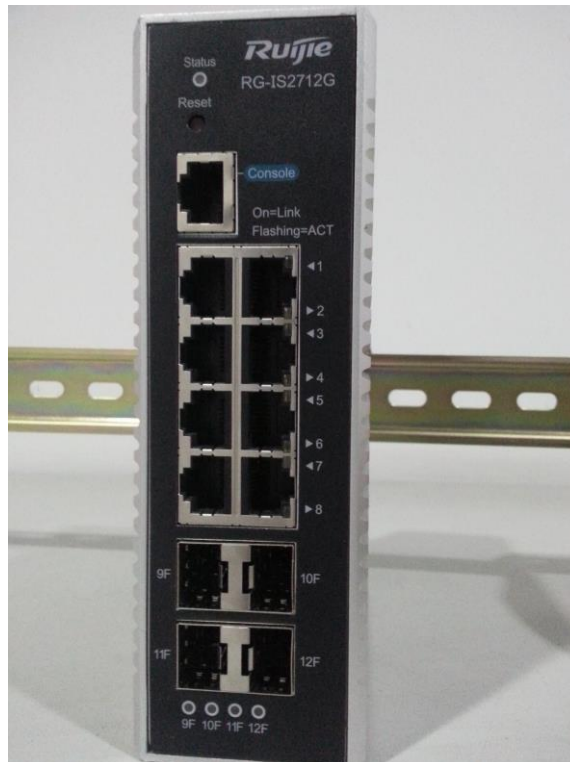
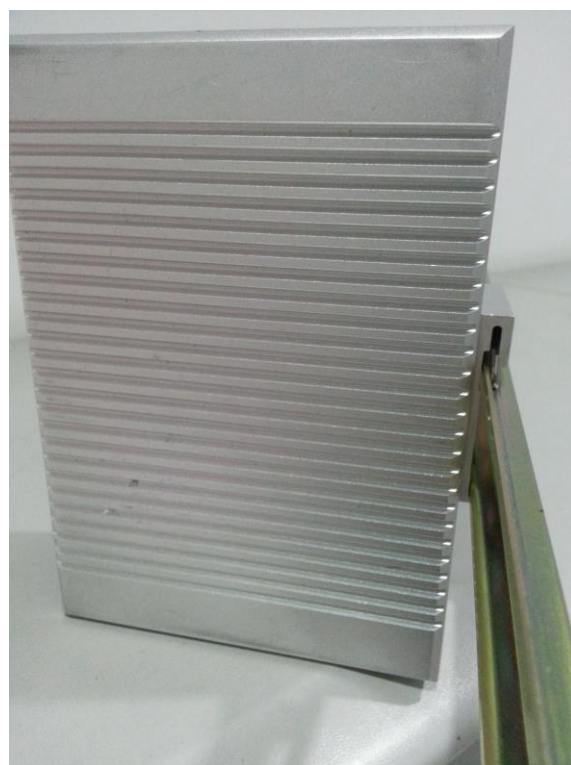

Figure 3-3



Figure 3-4



3.3.3 Connecting Power Cord to Power Connector

3.3.3.1 RG-IS2706G and RG-IS2712G

1. Insert the power cord into the 6-pin connector, as shown in Figure 3-8. 1 indicates the protective earth (PE) ground wire, which is green with yellow strip. 2 indicates the neutral wire (N wire), which is green or blue. 3 indicates the line voltage wire (L wire), which is red or brown.

Figure 3-5

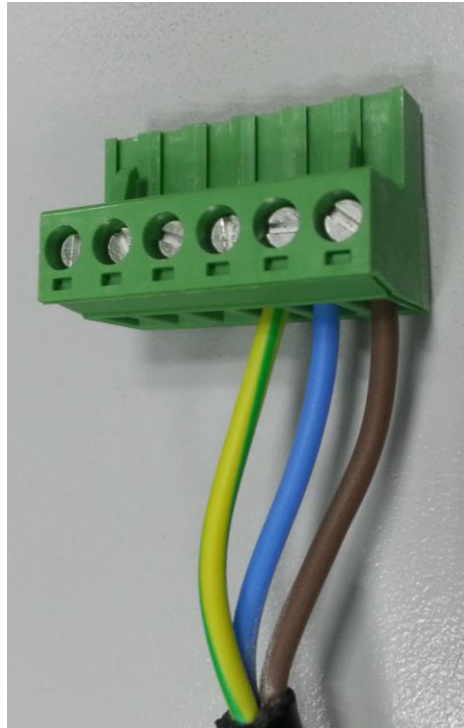

2. Turn bolts on the connector clockwise and plug the connector into the switch.

Figure 3-6



Figure 3-7

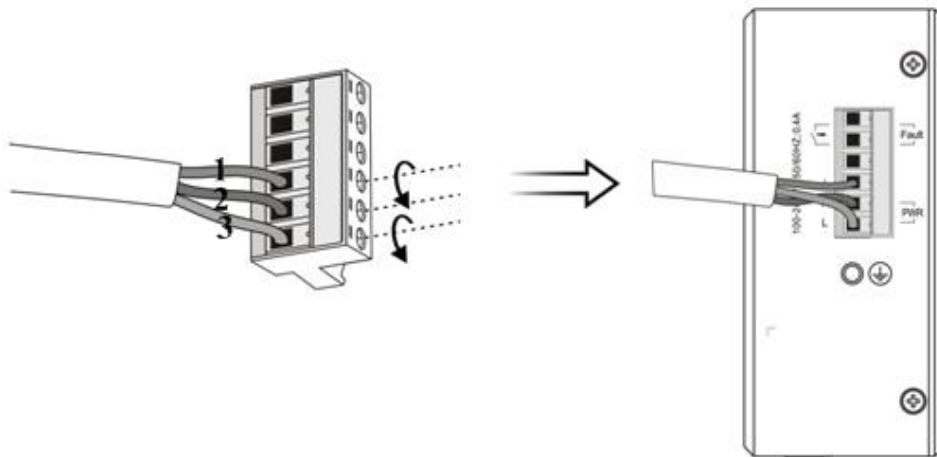

3.3.3.2 RG-IS2712G-DC

1. Two two-pin wires are needed. Insert the power cords into the 6-pin connector, as shown in Figure 3-8. V1+ and V2+ (red wires) indicate the positive poles of power supplies while V1- and V2- (black wires) indicate the negative poles.

Figure 3-8

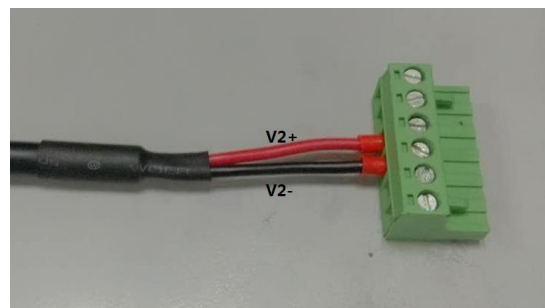
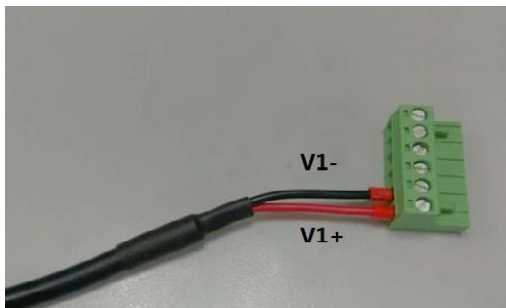

2. Turn bolts on the connector clockwise and plug the connector into the switch.

Flugre 3-9



-
-  The RG-IS2712G-DC switch adopts the DC power input. Two power supplies are supported for 1+1 power redundancy.
-

3.4 Checking after Installation

 Before checking the installation, switch off the power supply so as to avoid any personal injury or damage to the component due to connection errors.

- Check that the ground line is connected.
- Check that the cables and power input cables are correctly connected.
- Check that sufficient airflow is available around the device.

4 System Debugging

4.1 Establishing the Configuration Environment

Establishing the Configuration Environment

Connect the PC to the console port of the switch through the console cable, as shown in Figure 4-1.

Figure 4-1 Schematic diagram of the configuration environment

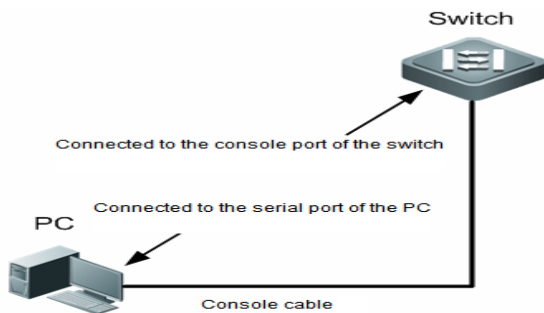

4.1.1 Connecting the Console Cable

Step 1: Connect one end of the DB-9 jack of the console cable to the serial port of the PC.

Step 2: Connect one end of the console cable RJ45 to the console port of the switch.

4.1.2 Setting Terminal Parameters

Step 1: Start the PC and run the terminal simulation program on the PC, such as Terminal on Windows 3.1 or HyperTerminal on Windows 95/98/NT/2000/XP.

Step 2: Set terminal parameters. The parameters are as follows: baud rate 9600, data bit 8, parity check none, stop bit 1, and flow control as none.

Choose **Start > Programs > Accessories > Communications > Hyperterminal**. The hyperterminal window appears.

Choose **Cancel**, the interface as shown in Figure 4-2 is displayed.

Figure 4-2

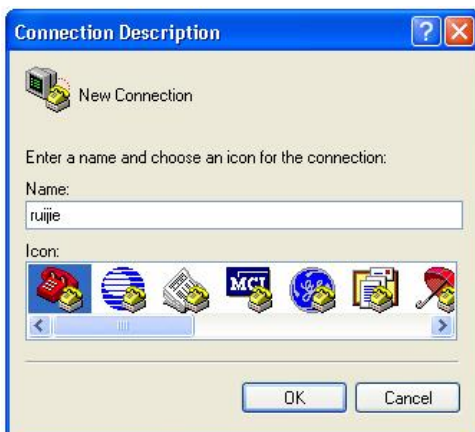

In the Connectivity Note window, type the name of the new connection and click OK. A window appears as shown in Figure 4-3. In the Connect Using field, select the serial port you want to use.

Figure 4-3



After selecting the serial port, click OK. The Serial Port Parameter Setting window is displayed, as shown in Figure 4-4. Set the baud rate to 9600, data bit to 8, parity check to none, stop bit to 1, and flow control to none.

Figure 4-4

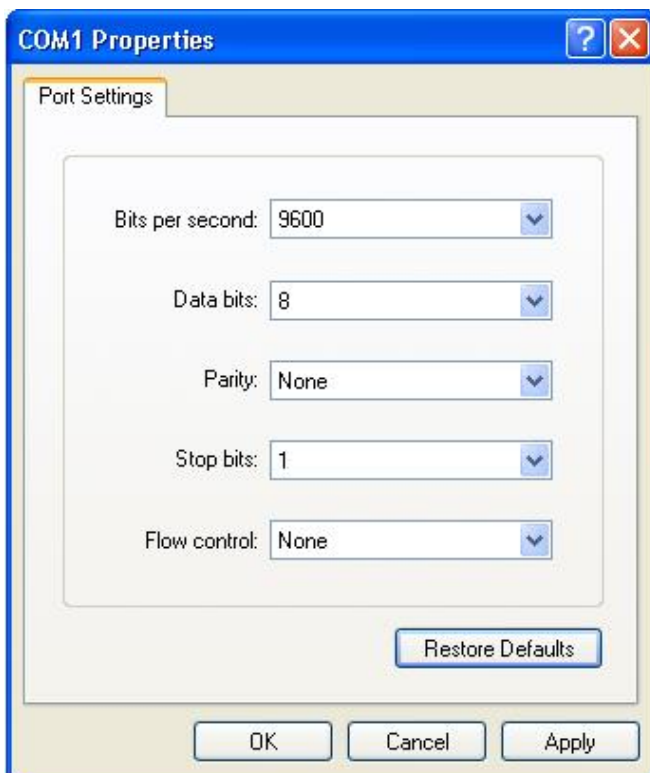

After setting the serial port parameters, click OK. The Hyperterminal window appears.

4.2 Power-on Startup

Checking before Power-on

- The switch is fully grounded.
- The power cable is correctly connected.
- The power supply voltage complies with the requirement of the switch.
- The console cable is correctly connected; the terminal (can be a PC) used for configuration is already started; the parameters are already configured.

Checking after Power-on (Recommended)

After power-on, you are recommended to perform the following checks to ensure the normal operation of follow-up configurations.

- Check that information is displayed on the terminal interface.
- Check that the device indicator is normal.

5 Maintenance and Troubleshooting

5.1 General Troubleshooting Procedure

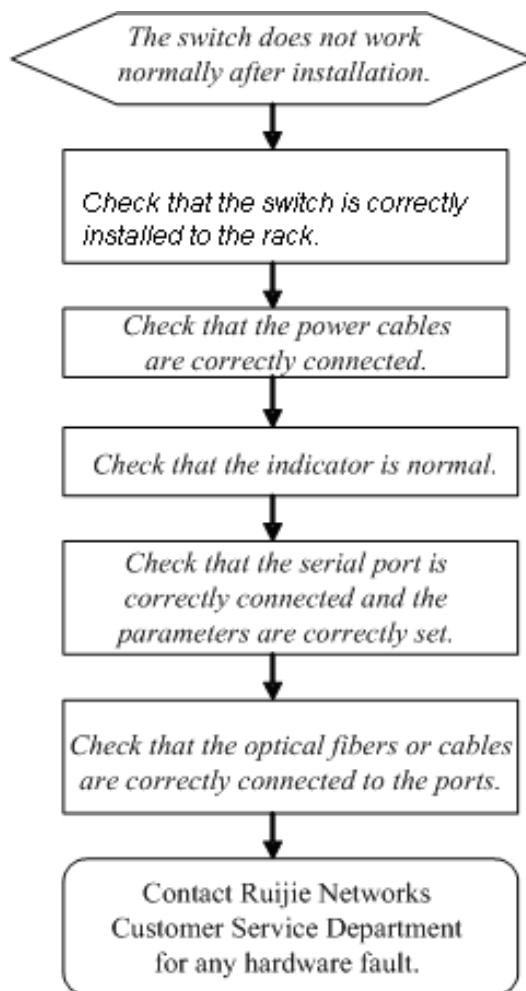

5.2 Troubleshooting Common Faults

Symptom	Possible Causes	Solution
Forgetting the management interface login password		Please contact Ruijie Networks Customer Service Department for technical support.
The status indicator is not on after the switch is started.	The power supply module does not supply power. The power cable is in loose contact.	Check whether the power socket at the equipment room is normal and whether the power cable of the switch is in good contact.
The status indicator is red.	Temperature alarm	At this time, the switch already stops the normal service exchanges. Check in time the

Symptom	Possible Causes	Solution
		working environment of the switch, clean the dust on the cabinet and reinforce the refrigeration effect.
The serial port console has no output or outputs illegible characters.	The serial port connected to the switch does not match that opened by the configuration software. The serial port is not configured correctly.	Change the serial port opened by the configuration software to be the one connected to the switch. Check that the parameter configuration of the serial port matches that specified in the instructions.
The RJ45 port is not in connectivity or it is erroneous in receiving/transmitting frames.	The connected twisted pair cable is faulty. The length of the cable exceeds 100 m. The port has special configuration that has no common working mode with the connected switch.	Replace the twisted pair cable. Check that the port configuration has the common working mode with the connected switch.
The fiber port cannot be connected.	The Rx and Tx ends are connected reversely. The interconnected optical module type does not match. The fiber type is not correct. The length of the optical fiber exceeds that rated of the optical module.	Switch the Rx and Tx ends of the optical fiber. Replace the optical module with one of the matched type. Replace the optical fiber with one of the appropriate type. Replace the optical fiber with one of the appropriate length.

6 Appendix A Connectors and Connection Media

1000BASE-T/100BASE-TX/10BASE-T Ports

The 1000BASE-T/100BASE-TX/10BASE-T is a port that supports adaptation of three rates, and automatic MDI/MDIX Crossover at these three rates.

The 1000BASE-T complies with IEEE 802.3ab, and uses the cable of 100-ohm Category-5 or Supper Category-5 UTP or STP, which can be up to 100 m.

The 1000BASE-T port uses four pairs of wires for transmission, all of which must be connected. 0 shows the connections of the twisted pairs used by the 1000BASE-T port.

Figure A-1 Schematic diagram for the four twisted pairs of the 1000BASE-T

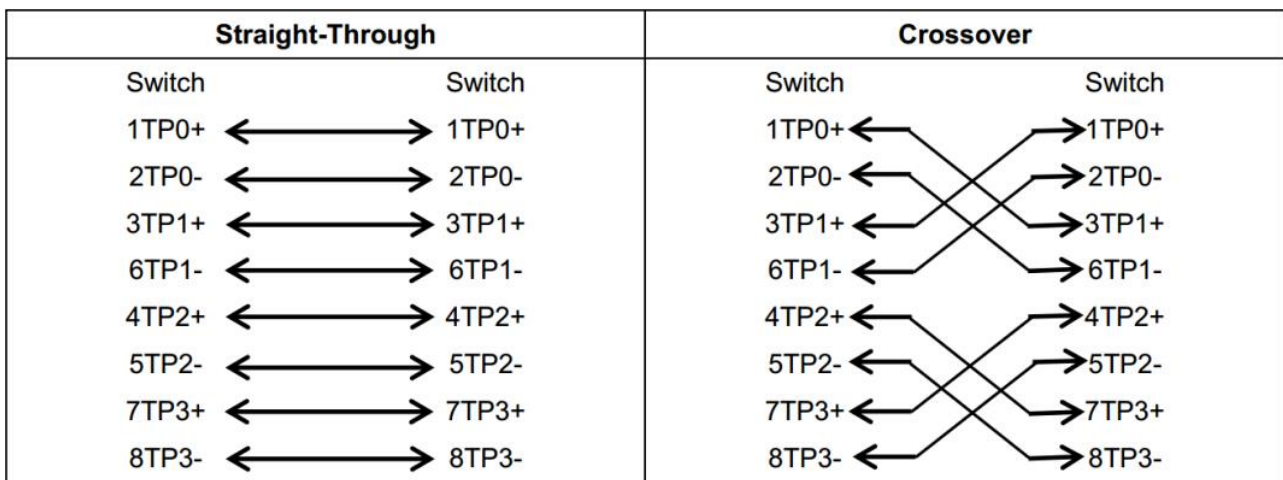

In addition to the above cables, the 100BASE-TX/10BASE-T can also use 100-ohm Category-3, 4, 5 cables for 10 Mbps, and 100-ohm Category-5 cables for 100 Mbps, both of which can be up to 100 m. Figure A-2 shows the pinouts of the 100BASE-TX/10BASE-T.

Figure A-2 Pinouts of the 100BASE-TX/10BASE-T

Pin	Socket	Plug
1	Input Receive Data+	Output Transmit Data+
2	Input Receive Data-	Output Transmit Data-
3	Output Transmit Data+	Input Receive Data+
6	Output Transmit Data-	Input Receive Data-
4,5,7,8	Not used	Not used

0 shows the straight-through and crossover cable connections for the 100BASE-TX/10BASE-T.

Figure A-3 Connections of the twisted pairs of the 100BASE-TX/10BASE-T

Straight-Through		Crossover	
Switch	Adapter	Switch	Switch
1 IRD+	1 OTD+	1 IRD+	OTD+
2 IRD-	2 OTD-	2 IRD-	OTD-
3 OTD+	3 IRD+	3 OTD+	3 IRD+
6 OTD-	6 IRD-	6 OTD-	3 IRD+

Fiber-Optic Connection

For fiber ports, select single-mode or multimode fibers for connection according to the fiber module connected. The connection schematic diagram is shown in 0:

Figure A-4 Schematic diagram for fiber connection

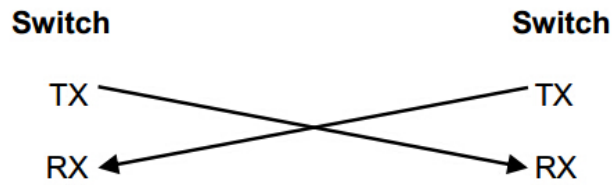

7 Appendix B Mini-GBIC Modules

We provide appropriate 1000M SFP modules (Mini-GBIC modules) for different module interfaces of the switch. You can select the SFP module as needed. The following models and technical specifications of some 1000M SFP modules are listed for your reference.

Models and Technical Specifications of the Mini-GBIC (SFP) Module

Table B-1 Models and Technical Specifications of the SFP Module

Mini-GBIC(SFP)	Wavelength (nm)	Fiber Type	Connector Type	Core Size (micron)	Cabling Distance	Transmit Sensitivity (dbm)		Receive Sensitivity (dbm)		DDM (Yes/No)
						MIN	MAX	MIN	MAX	
MINI-GBIC-SX-MM850	850	MMF ¹	LC	62.5/125	275m	-9.5	-3	-17	0	No
				50/125	550m					
MINI-GBIC-LX-SM1310	1310	SMF ²	LC	9/125	10km	-9.5	-3	-20	-3	No
MINI-GBIC-LH40-SM1310	1310	SMF ²	LC	9/125	40km	-2	3	-22	-3	Yes
MINI-GBIC-ZX50-SM1550	1550	SMF ²	LC	9/125	50km	-5	0	-22	-3	Yes
MINI-GBIC-ZX80-SM1550					80km	0	4.7	-22	-3	
MINI-GBIC-ZX100-SM1550					100km	0	5	-30	-9	
GE-eSFP-SX-MM850	850	MMF ¹	LC	62.5/125	275m	-9.5	-3	-17	0	Yes
				50/125	550m					
GE-eSFP-LX-SM1310	1310	SMF ²	LC	9/125	10km	-9.5	-3	-20	-3	Yes
GE-SFP-LX20-SM1310-BIDI	1310TX/ 1550RX	SMF ²	LC	9/125	20km	-9	-3	-20	-3	Yes
GE-SFP-LX20-SM1550-BIDI	1550TX/ 1310RX	SMF ²	LC	9/125	20km	-9	-3	-20	-3	Yes
GE-SFP-LH40-SM1310-BIDI	1310TX/ 1550RX	SMF ²	LC	9/125	40km	-5	0	-24	-1	Yes
GE-SFP-LH40-SM1550-BIDI	1550TX/ 1310RX	SMF ²	LC	9/125	40km	-5	0	-24	-1	Yes
Mini-GBIC-GT	N/A	Cable	RJ45 connector	CAT5/5E/6 STP/ UTP	100m	N/A		N/A		No

1 MMF=Multimode fiber

2 SMF=Single mode fiber



-  When using shorter distances of single-mode fiber for optical SFP transceivers with cable distance greater than 40 km (including 40 km), you may need to insert an in-line optical attenuator in the link to avoid overloading the receiver.
-  The optic module is a laser emitter. Please do not look at the light source to avoid hurting your eyes.
-  Please cover the optic module with a dust shield when it is not in use to keep it clean.

Table B-2 Model and Technical Specification of 1000Base-T Copper SFP Module

Model	Copper Cable Type	Connector Type	Copper Cable Length	Wire Diameter(A WG)	Data Rate(G b/s)	DDM (Yes/No)
GE-SFP-STACK1.6M	Passive Cable	SFP	1.6m	28	2.5G	No



-  Please pay attention to ESD protection when handling copper cables.
-  Please make sure the bend radius of the copper cable is not less than 8 times of its diameter,

Table B-3 Pairing Models of the SFP BIDI Optic Module

Rate/Distance	Pairing Models
1G/20km	GE-SFP-LX20-SM1310-BIDI GE-SFP-LX20-SM1550-BIDI
1G/40km	GE-SFP-LH40-SM1310-BIDI GE-SFP-LH40-SM1550-BIDI

-  BIDI optic modules must be used in pairs. If GE-SFP-LX20-SM1310-BIDI is used at one end, then GE-SFP-LX20-SM1550-BIDI must be applied to the other end.